



# IxLoad

## Tcl API Programming Guide

Includes Python and PERL Support

Version 8.30

June 2017



## Copyright and Disclaimer

Copyright © 2017 Ixia. All rights reserved.

This publication may not be copied, in whole or in part, without Ixia's consent.

Ixia, the Ixia logo, and all Ixia brand names and product names in this document are either trademarks or registered trademarks of Ixia in the United States and/or other countries. All other trademarks belong to their respective owners.

The information herein is furnished for informational use only, is subject to change by Ixia without notice, and should not be construed as a commitment by Ixia. Ixia assumes no responsibility or liability for any errors or inaccuracies contained in this publication.

## RESTRICTED RIGHTS NOTICE

As prescribed by FAR 27.409(b)(4) and in accordance with FAR 52.227-14, please take notice of the following.

- (a) This proprietary computer software and/or software technical data is submitted with restricted rights. It may not be used, reproduced, or disclosed by the Government except as provided in paragraph (b) of this notice or as otherwise expressly stated in the applicable contract.
- (b) This computer software and/or software technical data may be—
  - (1) Used or copied for use with the computer(s) for which it was acquired, including use at any Government installation to which the computer(s) may be transferred;
  - (2) Used or copied for use with a backup computer if any computer for which it was acquired is inoperative;
  - (3) Reproduced for safekeeping (archives) or backup purposes;
  - (4) Modified, adapted, or combined with other computer software, provided that the modified, adapted, or combined portions of the derivative software incorporating any of the delivered, restricted computer software shall be subject to the same restricted rights;
  - (5) Disclosed to and reproduced for use by support service Contractors or their subcontractors in accordance with paragraphs (b)(1) through (4) of this notice; and
  - (6) Used or copied for use with a replacement computer.
- (c) Notwithstanding the foregoing, if this computer software and/or software technical data is copyrighted computer software and/or software technical data, it is licensed to the Government with the minimum rights set forth in paragraph (b) of this notice.
- (d) Any other rights or limitations regarding the use, duplication, or disclosure of this computer software and/or software technical data are to be expressly stated in, or incorporated in, the applicable contract.
- (e) This notice shall be marked on any reproduction of this computer software, in whole or in part.

(End of notice)

## Contacting Ixia

Corporate Headquarters	<p>Ixia Worldwide Headquarters          26601 W. Agoura Rd.          Calabasas, CA 91302          USA          +1 877 FOR IXIA (877 367 4942)          +1 818 871 1800 (International)          (FAX) +1 818 871 1805  <a href="mailto:sales@ixiacom.com">sales@ixiacom.com</a></p>	<p>Web site: <a href="http://www.ixiacom.com">www.ixiacom.com</a>          General: <a href="mailto:info@ixiacom.com">info@ixiacom.com</a>          Investor Relations: <a href="mailto:ir@ixiacom.com">ir@ixiacom.com</a>          Training: <a href="mailto:training@ixiacom.com">training@ixiacom.com</a>          Support: <a href="mailto:support@ixiacom.com">support@ixiacom.com</a>          +1 818 595 2599</p>
EMEA	<p>Ixia Europe Limited          Part 2nd floor,          Clarion House, Norreys Drive          Maidenhead, UK SL6 4FL          +44 (1628) 408750          FAX +44 (1628) 639916  <a href="mailto:salesemea@ixiacom.com">salesemea@ixiacom.com</a></p>	<p>Support: <a href="mailto:support-emea@ixiacom.com">support-emea@ixiacom.com</a>          +40 21 301 5699</p>
Asia Pacific	<p>Ixia Pte Ltd          210 Middle Road          #08-01 IOI Plaza          Singapore 188994</p>	<p>Support: <a href="mailto:support-asiapac@ixiacom.com">support-asiapac@ixiacom.com</a>          +91 80 4939 6410</p>
Japan	<p>Ixia KK          Nishi-Shinjuku Mitsui Bldg 11F          6-24-1, Nishi-Shinjuku, Shinjuku-ku          Tokyo 160-0023          Japan</p>	<p>Support: <a href="mailto:support-japan@ixiacom.com">support-japan@ixiacom.com</a>          +81 3 5326 1980</p>
India	<p>Ixia Technologies Pvt Ltd          Tower 1, 7th Floor, UMIYA Business Bay          Cessna Business Park          Survey No. 10/1A, 10/2, 11 &amp; 13/2          Outer Ring Road, Varthur Hobli          Kadubeesanahalli Village          Bangalore East Taluk          Bangalore-560 037, Karnataka, India          +91 80 42862600</p>	<p>Support: <a href="mailto:support-india@ixiacom.com">support-india@ixiacom.com</a>          +91 80 4939 6410</p>
China	<p>Ixia Technologies (Shanghai) Company Ltd          Unit 3, 11th Floor, Raffles City, Beijing          Beijing, 100007 P.R.C.</p>	<p>Support: <a href="mailto:support-china@ixiacom.com">support-china@ixiacom.com</a>          400 898 0598 (Greater China Region)          +86 10 5732 3932 (Hong Kong)</p>

This page intentionally left blank.

# CONTENTS

<b>Contacting Ixia</b> .....	<b>iii</b>
<b>CONTENTS</b> .....	<b>v</b>
<b>About this Guide</b> .....	<b>1</b>
Conventions .....	1
Related Documentation .....	2
<b>Introduction</b> .....	<b>3</b>
Background Reading .....	3
Network Setup .....	5
Backward Compatibility .....	9
Deprecated Commands .....	9
Python Support .....	10
PERL Support .....	13
<b>Quick Start</b> .....	<b>19</b>
Windows .....	19
Unix/Linux .....	22
Editing the setup_simple.tcl script .....	24
Running the sample scripts .....	25
Monitoring Status and Retrieving Results .....	25
<b>API Overview</b> .....	<b>27</b>
Tcl API Structure .....	27
General API Conventions .....	30
TCL API Internal Overview .....	35

Building an IxLoad Test .....	38
Running an IxLoad Tcl Script .....	66
API Description .....	69
Sample Scripts Shipped with IxLoad .....	81
Example Program .....	85
<b>IxLoad Tcl API Commands .....</b>	<b>115</b>
::IxLoad .....	115
ixChassisChain .....	117
IxChassisBuilder .....	120
ixCustomPortMap .....	126
ixPlaylists .....	128
ixPort .....	131
ixSubmap .....	133
ixSubmapRange .....	134
ixIntRange .....	135
ixRepository .....	136
ixSendEventCommand .....	137
ixStatCatalogItem .....	139
ixStatFilter .....	140
ixStatSpec .....	142
ixTest .....	144
ixTestController .....	146
ixTestControllerMonitor .....	154
statCollectorUtils .....	155
ixScriptGen .....	165
ixTimeline .....	167
ixSubscriberNetTraffic .....	172

---

ixNetTraffic .....	173
activityList .....	179
ixTrafficFlow .....	179
ixTrafficColumn .....	180
ixNetworkGroup .....	181
ixDut .....	183
ixDutConfigVirtual .....	185
ixDutNetworkRange .....	186
ixDutProtocolPortRange .....	188
ixDutConfigVip .....	189
ixDutConfigSLB .....	190
ixView .....	191
ixClientNetwork .....	192
ixClientTraffic .....	196
ixClientTrafficNetworkMapping .....	198
ixNetworkRange .....	206
ixServerNetwork .....	209
ixServerTraffic .....	213
ixServerTrafficNetworkMapping .....	215
ixWaitEventCommand .....	217
<b>Internal Commands .....</b>	<b>221</b>
duplicate .....	221
ixConfig .....	221
ixConfigSequenceContainer .....	222
ixConfigSortedNamedItemList .....	224
<b>Network Stack API .....</b>	<b>229</b>
Network Stack Overview .....	229

Network Group Overview .....	230
Global plugins .....	231
Stacks and Protocol Plugins .....	232
Ethernet Plugin .....	235
Layer 2 Protocols (MAC / VLAN) .....	241
Emulated Router Plugin .....	253
IP Plugin .....	262
StaticARP .....	271
DHCP Client and Server .....	272
Authentication Extension Plugins .....	275
Impair Plugin .....	284
IPSec Plugin .....	305
PPPoX Plugin .....	360
L2TP Plugin .....	372
GTPSPlugin .....	403
eGTP Plugin .....	405
DSLite Plugin .....	406
Global Services Plugins .....	408
Mobile Subscribers Plugins .....	424
<b>AppReplay</b> .....	<b>437</b>
Objectives .....	437
Application Replay Peer Agent .....	438
Global Statistics .....	458
<b>AppMix</b> .....	<b>467</b>
Creating an AppMix Object .....	468
Adding Flows to an AppMix Object .....	469
Setting Flow Parameters .....	470



---

Configuring Flow Commands .....	471
Flow Protocols .....	472
Setting Flow Endpoints .....	474
Flow Endpoints .....	475
<b>Bulk MGCP .....</b>	<b>477</b>
API Overview .....	477
MGCP Client API .....	477
MGCP Server API .....	483
Parameters .....	486
MGCP Client Agent .....	489
MGCP Server Agent .....	507
Bulk MGCP Statistics .....	518
<b>Bulk SIP .....</b>	<b>533</b>
Overview .....	533
Objectives .....	534
SIP Client Commands .....	535
SIP Server Commands .....	546
SIP Client Agent .....	555
SIP Server Agent .....	586
Using Variables in SIP Fields .....	596
Bulk SIP Statistics .....	598
<b>CIFS .....</b>	<b>629</b>
API Overview .....	629
CIFS Client Agent .....	631
CIFS Server Agent .....	640
Statistics .....	651
<b>DHCP .....</b>	<b>667</b>

Overview .....	667
DHCP Client Agent .....	668
DHCP Command List .....	670
Advanced Options .....	678
Relay Agent .....	680
Option .....	682
IP Address .....	693
Using Variables in DHCP Fields .....	694
DHCP Statistics .....	696
<b>DNS .....</b>	<b>709</b>
Overview .....	709
DNS Client Agent .....	710
DNS Server Agent .....	716
DNS Statistics .....	726
<b>FTP .....</b>	<b>741</b>
Overview .....	741
Objectives .....	741
FTP Client Agent .....	742
FTP Server Agent .....	744
FTP Client Agent .....	746
FTP Server Agent .....	753
FTP Statistics .....	756
<b>HTTP .....</b>	<b>763</b>
Overview .....	763
HTTP Client Agent .....	765
HTTP Server Agent .....	783

---

Using Sequence Generators in HTTP Client Commands and Server Header Name=Value Fields .....	806
Statistics .....	809
<b>IMAP .....</b>	<b>845</b>
API Overview .....	845
IMAP Client Agent .....	847
IMAP Server Agent .....	858
Using Auto-Generated Strings .....	871
IMAP Statistics .....	872
<b>IPTV/ Video .....</b>	<b>883</b>
Overview .....	883
Video Client Agent .....	886
Video Server Agent .....	920
IPTV / Video Statistics .....	930
<b>iSCSI .....</b>	<b>975</b>
API Overview .....	975
iSCSI Client Agent .....	977
iSCSI Server Agent .....	985
<b>IxIO .....</b>	<b>993</b>
API Overview .....	993
IxIO Client Agent .....	994
<b>LDAP .....</b>	<b>1005</b>
Overview .....	1005
LDAP Client Agent .....	1009
LDAP Statistics .....	1027
<b>Peer-to-Peer Application .....</b>	<b>1035</b>
Objectives .....	1035

Peer-to-Peer Application Agent .....	1036
Peer-to-peer Global Statistics .....	1041
<b>POP3 .....</b>	<b>1047</b>
Overview .....	1047
POP3 Client Agent .....	1050
POP3 Server Agent .....	1057
Using Auto-Generated Strings .....	1060
POP3 Statistics .....	1061
<b>Published Vulnerabilities and Malware .....</b>	<b>1069</b>
config .....	1070
advOptions .....	1072
attacksCmdList .....	1073
AddAttacks .....	1079
AttackListCount .....	1080
CreateAttackList .....	1081
CreatePlaylist .....	1082
DatabaseVersion .....	1083
DeleteAttackList .....	1084
DeleteAttacks .....	1085
ExportAttacks .....	1086
GetCapture .....	1087
ImportAttacks (.zatk format) .....	1088
ImportUserDefinedAttacks .....	1089
RenameAttackList .....	1090
RetrieveAttacks .....	1091
SearchAttacks .....	1092
<b>QT .....</b>	<b>1095</b>

---

Running a QuickTest from Tcl .....	1096
startQuickTest .....	1097
checkTestRunning .....	1098
stopQuickTest .....	1099
QuickTest Sample Script .....	1100
<b>Radius .....</b>	<b>1103</b>
Overview .....	1103
Radius Client Agent .....	1107
RADIUS Client Statistics .....	1123
<b>RTSP .....</b>	<b>1131</b>
Overview .....	1131
RTSP Client Agent .....	1136
RTSP Server Agent .....	1150
RTSP Statistics .....	1159
<b>SMTP .....</b>	<b>1173</b>
Overview .....	1173
SMTP Client Agent .....	1177
SMTP Server Agent .....	1191
SMTP Statistics .....	1193
<b>SSH .....</b>	<b>1201</b>
API Overview .....	1201
SSH Client Agent .....	1204
SSH Client Statistics .....	1218
<b>Stateless Peer .....</b>	<b>1223</b>
Stateless Peer Overview .....	1223
Stateless Peer Agent .....	1225
<b>HTTP Streaming .....</b>	<b>1237</b>

API Overview .....	1237
HTTP Streaming Client Agent .....	1238
<b>Telnet .....</b>	<b>1255</b>
API Overview .....	1255
Telnet Client Agent .....	1260
Telnet Server Agent .....	1268
Telnet Statistics .....	1273
<b>TFTP .....</b>	<b>1285</b>
Overview .....	1285
TFTP Client Agent .....	1288
TFTP Server Agent .....	1296
TFTP Client Statistics .....	1302
TFTP Server Statistics .....	1306
<b>Trace File Replay .....</b>	<b>1309</b>
Overview .....	1309
Trace File Replay Client Agent .....	1314
Trace File Replay Server Agent .....	1320
Statistics .....	1325
<b>VDI .....</b>	<b>1331</b>
API Overview .....	1331
VDI Client Agent .....	1332
<b>VoIP H.248 Peer .....</b>	<b>1335</b>
Limitations .....	1335
VoIP H248 Peer API Commands .....	1336
VoIP H248 Peer Agent .....	1340
Simulated MGC .....	1347
Simulated MGW .....	1349

---

H248 TermGroups .....	1351
MGW Automatic .....	1353
MGC Automatic .....	1356
Profiles .....	1361
Packages .....	1362
Events .....	1364
Properties .....	1365
Signals .....	1366
Statistics .....	1367
H248 Settings .....	1368
Codec Settings .....	1370
Data Codecs .....	1371
Codecs .....	1373
Other Settings .....	1379
SDP Settings .....	1381
RTP Settings .....	1383
Audio Settings .....	1385
Execution Settings .....	1389
Scenario Settings .....	1391
<b>VoIP H.323 Peer .....</b>	<b>1393</b>
API Overview .....	1393
VoIP H323 Peer API Commands .....	1394
VoIP H323 Peer Agent .....	1396
Codec Settings .....	1407
Codecs .....	1408
Data Codecs .....	1414
Other Settings .....	1416

RTP Settings .....	1418
Audio Settings .....	1420
Video Settings .....	1424
Alternative Capability Value Set List .....	1429
Capability List .....	1430
Custom Activity Link Settings .....	1431
Execution Settings .....	1433
Simultaneous Capability .....	1435
H323 Settings .....	1436
Simultaneous Capability Value Set List .....	1440
Alternative Capability List .....	1441
Alternative Capability .....	1442
Dial Plan .....	1443
Terminal Capability Set .....	1446
Simultaneous Capability List .....	1447
Scenario Settings .....	1448
Custom Parameters .....	1449
<b>VoIP MGCP .....</b>	<b>1451</b>
Limitations .....	1451
VoIP MGCP Peer API Commands .....	1452
MGCP GW Agent .....	1456
MGCP Settings (GW) .....	1465
Automatic Settings (GW) .....	1467
Endpoints .....	1469
MGCP CA Agent .....	1470
MGCP Settings (CA) .....	1472
Automatic Settings (CA) .....	1474



---

Endpoints .....	1476
Gateways .....	1478
Scenario Settings .....	1480
Execution Settings .....	1481
Custom Activity Link Settings .....	1483
Simulated Endpoints .....	1487
Data Codecs .....	1489
Codecs .....	1491
SDP Settings .....	1496
RTP Settings .....	1497
Audio Settings .....	1499
Other Settings .....	1503
<b>VoIP SIP Cloud .....</b>	<b>1505</b>
Limitations .....	1505
VoIP SIP Cloud API Commands .....	1506
VoIPSIP Cloud Agent .....	1508
Settings .....	1510
SIP Server List .....	1511
<b>VoIP SIP Peer .....</b>	<b>1513</b>
Limitations .....	1513
VoIP SIP Peer API Commands .....	1514
VoIP SIP Peer Agent .....	1517
Codec Settings .....	1540
Data Codecs .....	1541
Codecs .....	1543
Other Settings .....	1550
Signaling Settings .....	1553

Edit Contact .....	1557
RTP Settings .....	1559
Audio Settings .....	1561
Video Settings .....	1565
T.38 Settings .....	1569
T.30 Settings .....	1573
Timer Settings .....	1579
SRTP Settings .....	1581
MSRP Settings .....	1583
MSRP GUI Files .....	1586
MSRP Relays .....	1588
Custom Activity Link Settings .....	1589
Execution Settings .....	1592
Transfer Address .....	1595
Scenario Settings .....	1597
Dial Plan .....	1598
TLS Settings .....	1601
TLS Cyphers .....	1604
Custom Parameters .....	1605
Advanced Settings .....	1608
Cloud Servers .....	1609
Server Rules .....	1611
Cloud Rules .....	1612
RuleData .....	1614
<b>VoIP Skinny Peer .....</b>	<b>1617</b>
Limitations .....	1617
VoIP Skinny Peer API Commands .....	1618

---

VoIP Skinny Peer Agent .....	1620
Scenario Settings .....	1637
Execution Settings .....	1638
Dial Plan .....	1640
Skinny Settings .....	1645
Call Managers .....	1648
Codec Settings .....	1650
Data Codecs .....	1651
Codecs .....	1653
RTP Settings .....	1659
Audio Settings .....	1661
Other Settings .....	1665
Custom Activity Link Settings .....	1667
Custom Parameters .....	1669
<b>VoIP No Call Control Peer .....</b>	<b>1671</b>
Limitations .....	1671
VoIP No Call Control Peer API Commands .....	1672
VoIP No Call Control Peer API Objects .....	1673
VoIP No Call Control Peer Agent .....	1674
Scenario Settings .....	1691
Execution Settings .....	1692
Dial Plan .....	1694
Codec Settings .....	1696
Codecs .....	1698
Data Codecs .....	1705
Audio Settings .....	1707
Video Settings .....	1711

T.30 Settings .....	1715
T.38 Settings .....	1721
RTP Settings .....	1725
SRTP Settings .....	1727
Other Settings .....	1729
<b>IP, TCP, Run State, and Curve Segment L2/L3, and Port CPU Statistics .....</b>	<b>1731</b>
Per-Interface and TCP Statistics .....	1732
Run State Statistics .....	1743
Curve Segment Statistics .....	1745
Connection Latency Statistics .....	1746
IxServer Layer 2-3 Statistics .....	1748
IxServer Port CPU Statistics .....	1750
<b>INDEX .....</b>	<b>1751</b>

## About this Guide





This section contains information that explains the typographical conventions used in this documentation. This information will aid you in using the documentation most effectively. Also provided is a list of related documentation that you may find useful.

## Conventions

The following typographical conventions are used in this documentation:

- Italics are used to indicate the names of software fields and parameters, titles of books or documents, and first references to words, terms, phrases, or concepts that have a special meaning or require special identification or emphasis. For example:
  - In the *userid* field, enter your assigned user identification number.
  - *Norton's Telecom Dictionary* is a helpful reference tool.
  - The term *tolerance level* refers to the standard deviation setting.
  - The variable *n* represents any numerical value.
- Menu names and options appear as bold blue text in online Help, and appear in small capital letters in documents. For example:
  - To save your input, choose the File>Save menu option.
- Bold black type is used to indicate the names of buttons, commands, and files that are part of procedures, as well as to identify field and parameter options. In addition, bold text emphasizes important information in text or in caution, warning, or danger statements. For example:
  - To proceed to the next step, click **OK**.
  - Use the **copy** command to duplicate the field entry.
  - Save and close the **books.xml** file.
  - **Always** save your test configuration.
  - **Courier** text is used to indicate typed text input. For example:
    - Access the new file name at the command line: `c = newbook.gif.`
    - Enter the setup.ini location: `setupini = Ixia\Code\New.`
  - PC keys are indicated in all caps, using the following conventions:
    - Simultaneous keystrokes are shown by joining the key names with a plus sign (+), For example, **CTRL+Q**.
    - Sequential keystrokes are shown by joining the key names with a comma (,). For example, **SHIFT, F7**.

Icons are used throughout the documentation to draw attention to caution, warning, and danger statements. Icons also identify notes, important information, and the start of a procedure.

	<b>Caution:</b> Provides information that is needed to avoid potential harm to equipment or the environment.
	<b>Warning:</b> Provides information needed to prevent certain harm to a person, piece of equipment, or the environment.
	<b>DANGER:</b> Provides information to prevent certain severe bodily harm to a person.
	<b>Note:</b> Provides information that needs special attention within text.
	<b>IMPORTANT:</b> Provides information that is especially important for correct product operation.

## Related Documentation

The following documentation may be helpful in gaining more understanding of IxLoad. The documentation is available from the **Help** pull-down menu in IxLoad or from the IxLoad CD.

Ixia user documentation is also available in the Support>User Guides area of [ixiacom.com](http://www.ixiacom.com) (<http://www.ixiacom.com>). User registration is required to view this online documentation.

*Getting Started with Aptixia IxLoad*  
*IxLoad User Guide*

## Introduction

The *IxLoad Tcl API* is a set of Tcl commands that enable you to run IxLoad tests from Tcl scripts. The API provides most of the same capabilities available from the GUI.

## Background Reading

In order to use the Tcl API, you should also have the following other documents:

The *IxLoad User Guide* should be read and understood before attempting to use the API. In particular, the following two chapters are essential:

- *Introduction* discusses the background to understand Internet protocol testing in general and the manner in which Ixia approaches it specif
- *Creating and Running an IxLoad Test* describes how to create the test infrastructure. Care must be taken to assign IP addresses correctly and to provide required routes.

The *Creating and Running an IxLoad Test* chapter uses the term *Management Station* to refer to the host that runs the IxLoad GUI application. In this guide, that host is the host that runs a Tcl program using the IxLoad Tcl API is in this same position. We shall refer to this as the *Development Station* in the remainder of this manual.

The *Ixia Tcl Development Guide* describes the general method for developing Tcl scripts for use with Ixia equipment. Only a few of the commands described in that guide are necessary to construct an IxLoad Tcl API-based test, but you should review the entire guide to familiarize yourself with the general structure and functioning of Tcl-based tests.

## Using a License Server

If you are using a central license server with IxLoad, make sure to set the name of the server in IxLoad's Settings > Preferences menu choice.

To allow use of a central license server by the TCL API, the system environment variable *IXN\_LICENSE\_SERVER* must be set on the client PC.

If you are running your Tcl program on a Unix client, the *IXN\_LICENSE\_SERVER* environment variable must be set on the Windows host running the Tcl Server, and on the Unix client through the user shell initialization script.

To set the License Server environment variable on a Windows host:

1. Right-click on the My Computer icon on the desktop, then select Properties.
2. Click the Advanced tab.
3. Click **Environment Variables**.
4. In either the User variables for... or System variables lists, click New to add a new variable.
5. Name the variable `IXN_LICENSE_SERVER`.
6. Set the variable value to the name or IP address of the license server host.
7. Click **OK** to close the window.

## Configuring the ixMachineOptions.ini File

The `ixMachineOptions.ini` file contains parameters for configuring the license server used for Tcl scripts. In order to run IxLoad from Tcl scripts, you must configure these parameters, because there is no way to define a license server from an IxLoad Tcl API script.

The `ixMachineOptions.ini` file is created the first time you start IxLoad, and is stored in the following directory on the IxLoad client PC:

- **Windows XP:** `C:\Documents and Settings\All Users\Application Data\Ixia\IxLoad\<version>\`
- **Windows Vista and later:** `C:\ProgramData\Ixia\IxLoad\<version>\`

*License server parameters*

[GlobalOptions]	
license_server_enabled =	Specifies whether the license is stored on the test chassis or on an external license server. False: The license is stored on the same Ixia chassis that is being used by the Tcl script (Default). True: The license is stored on an external license server. Specify the license server's host name or IP address in the license_server parameter.
license_server =	If the license is stored on an external license server, specify its host name or IP address.

## License Server Parameters

The [GlobalOptions] section of the `IxAppOptions.ini` file contains two parameters that define the license server being used. In order to run IxLoad from Tcl scripts, you must configure these



parameters, because there is no way to define a license server from an IxLoad Tcl API script. The license server parameters are:

[GlobalOptions]	
license_server_enabled =	Specifies whether the license is stored on the test chassis or on an external license server. False: The license is stored on the same Ixia chassis that is being used by the Tcl script (Default). True: The license is stored on an external license server. Specify the license server's host name or IP address in the license_server parameter.
license_server =	If the license is stored on an external license server, specify its host name or IP address.

## Network Setup

You may need to configure IP addresses or routes for IxLoad Tcl API testing. Review the following sections to see if you need to set or change any addresses:

- To change the IxLoad Tcl API development station's IP address, see [Configuring a Network Address on the IxLoad Development Station](#) (see "[Configuring a Network Address on the IxLoad Development Station](#)").
- If the route to your Ixia chassis includes one or more routers, see [Configuring a Permanent Route to Ixia Ports](#) (see "[Configuring a Permanent Route to Ixia Ports](#)").
- If you need to change the internal network used by an Ixia chassis, see [Setting Ixia Chassis Base Addresses](#) (see "[Setting Ixia Chassis Base Addresses](#)").

## Configuring a Network Address on the IxLoad Development Station

To use the *IxLoad Tcl API*, you must configure your development station with an address on its local network that is routeable to all of the Ixia chassis that you will use for testing.

To configure routing:

1. Click Windows' **Start** button and select **Settings | Network** and **Dial-up Connections**. Windows displays the connections currently configured on your PC.

2. Right-click **Local Area Connection** and select **Properties**. Windows displays the Local Area Connections Properties window.
3. Click **Internet Protocol (TCP/IP)**, then click **Properties**. Windows displays the LAN connection's TCP/IP properties.
4. Click the **Use the following IP address** button, then enter addresses in the following fields:
  - *IP address*: Enter an IP address that is routeable to all the Ixia chassis that you will use for IxLoad testing.
  - *Subnet mask*: Enter a subnet mask appropriate to the IP address you entered.
  - *Default gateway*: Enter the IP address of the gateway you will use to access the network that the Ixia chassis are on.
5. If you want to use DNS, enter the DNS servers' IP addresses in the Preferred DNS server and Alternate DNS server fields.
6. Click **OK** to close the window.

## Testing the Development Station's Routing

After you have configured the development station's IP address, you should test its routing to ensure it can communicate with the Ixia chassis you will use with IxLoad.

To test the routing:

1. Click Windows' **Start** button and select Programs > Accessories > ComPrompt.

Windows displays a Command Prompt window.

Equation 1: -1.Ping Command

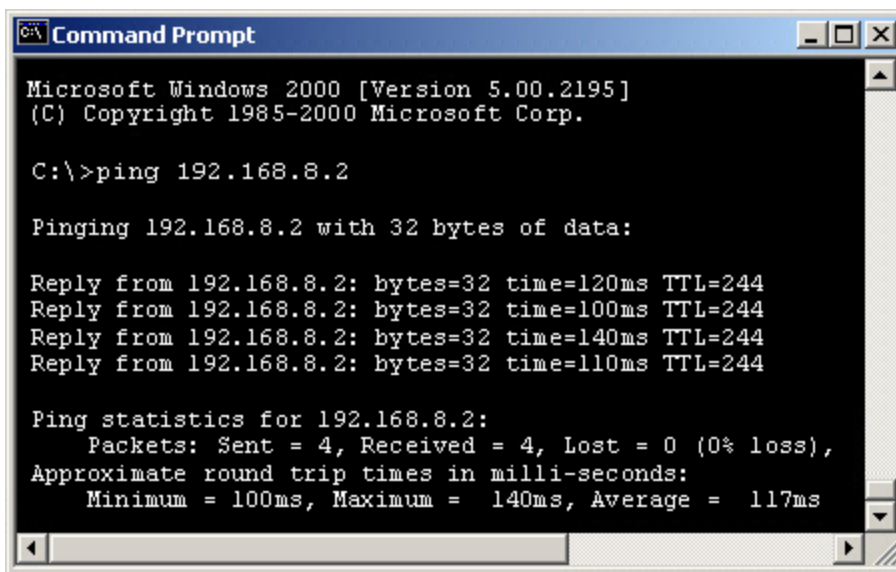

```
Microsoft Windows 2000 [Version 5.00.2195]
(C) Copyright 1985-2000 Microsoft Corp.

C:\>ping 192.168.8.2

Pinging 192.168.8.2 with 32 bytes of data:

Reply from 192.168.8.2: bytes=32 time=120ms TTL=244
Reply from 192.168.8.2: bytes=32 time=100ms TTL=244
Reply from 192.168.8.2: bytes=32 time=140ms TTL=244
Reply from 192.168.8.2: bytes=32 time=110ms TTL=244

Ping statistics for 192.168.8.2:
    Packets: Sent = 4, Received = 4, Lost = 0 (0% loss),
    Approximate round trip times in milli-seconds:
        Minimum = 100ms, Maximum = 140ms, Average = 117ms
```

2. Use the **ping** command to test that your development station can communiwith each chassis:  
`ping aaa.bbb.ccc.ddd`

(replace `aaa.bbb.ccc.ddd` with the IP address of the Ixia chassis).

3. Repeat the **ping** command for each chassis. Each chassis should return a reply. If any do not, check their TCP/IP configurations.



**Note:** You cannot ping Ixia ports (the chassis' internal 10.0.0.0 network) until you have started a test. Refer to **Configuring a Permanent Route to Ixia Ports** on page 1-6 on how to set up routing so you can access the addresses assigned to Ixia ports.

## Configuring a Permanent Route to Ixia Ports

You must configure a route from the IxLoad development station to the Ixia port management base addresses.

To establish a permanent route on a Windows system, you can either use the IxLoad GUI or the following procedure:

To establish a permanent route:

1. At the IxLoad development station, click Windows' **Start** button and select Programs > Accessories > Command Prompt.

Windows displays a Command Prompt window.

Equation 2: -2.Route Command

```
Microsoft Windows 2000 [Version 5.00.2195]
(C) Copyright 1985-2000 Microsoft Corp.

C:\>route -p ADD 10.0.0.0 mask 255.255.0.0 192.168.8.2 metric 1
```

2. Use the **route** command to create a permanent route:

```
route -p ADD 10.0.0.0 mask 255.255.0.0 aaa.bbb.ccc.ddd metric 1
```

- If the Ixia chassis is on the same subnet as the development station, replace `aaa.bbb.ccc.ddd` with the IP address of the Ixia chassis.
- Many IxLoad test environments resemble the one shown in the figure below: IxLoad Tcl API running on a PC connected to a corporate production network, an Ixia chassis connected to a test or QA network behind one or more routers, and a DUT network connected only to the Ixia chassis.

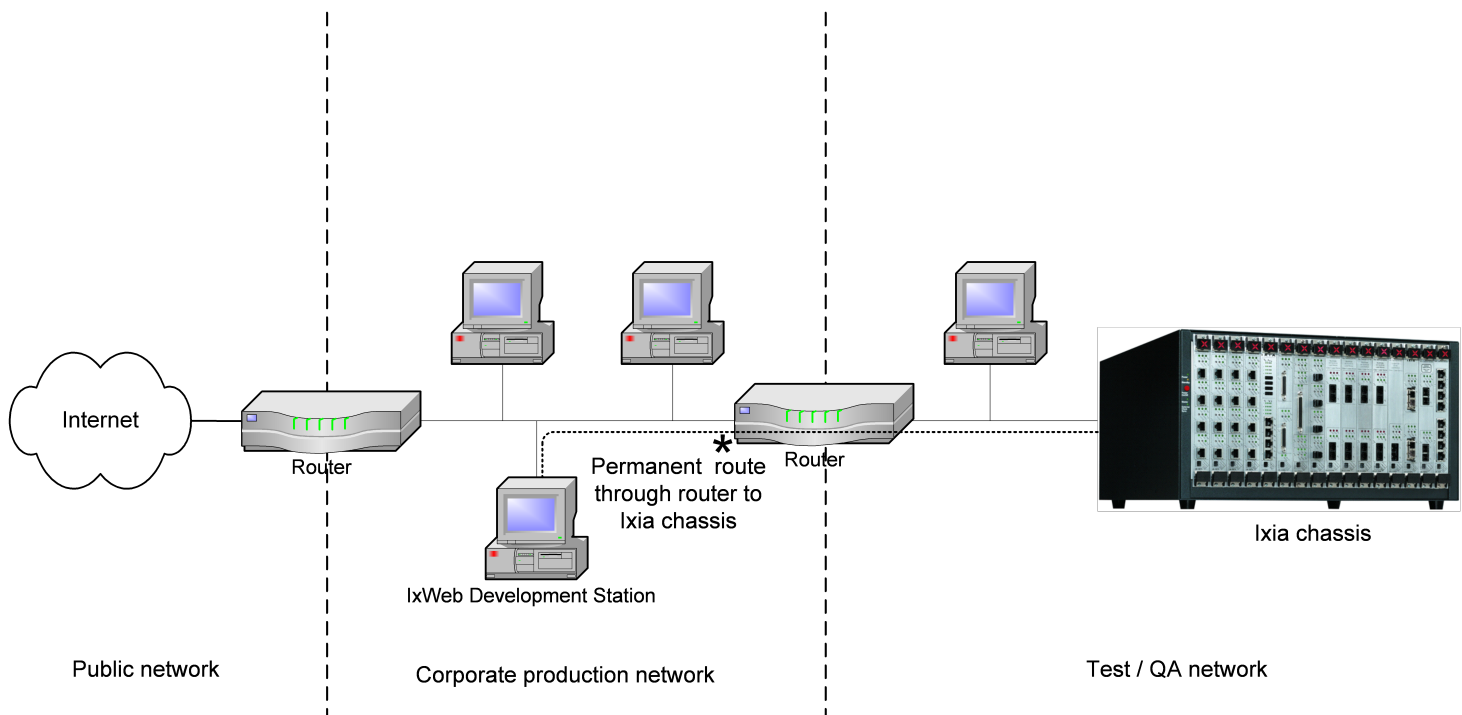

If the Ixia chassis is not on the same subnet as the development station, as shown in the figure above, replace `aaa.bbb.ccc.ddd` with the address of the router that will provide a connection to the Ixia chassis. That router, and all other intermediate routers to the chassis, should contain routes for the 10.0.0.0 (or modified) address range. These routes in the last router should refer to the Ixia chassis as a gateway.

Note that in a network shown like the one shown in the figure, the router(s) may be configured to disallow access from the production network, or they may route IxLoad requests intended for the Ixia ports (by default, a 10.0.0.0 network) elsewhere (usually to the Internet) or may drop them altogether.

Ensure that no other addresses assigned in IxLoad fall into this range. This setup may be tested using the ping command as described in [Testing the Development Station's Routing](#) (see "[Testing the Development Station's Routing](#)"), but only in the final stages of running a test.

## Setting Ixia Chassis Base Addresses

All ports on an Ixia chassis are initially configured so that they may be internally addressed, for IxLoad management purposes, as:

```
10.0.<card>.<port>
```

For example, card 2 port 3 has an internal IP address of 10.0.2.3. These addresses must be routeable from the development stations to the Ixia chassis.

The first two octets of the address (10.0) are called the *base address*. If you are using IxLoad on an existing network, you may want to change the base address to conform to your existing network layout. If two or more chassis are used for IxLoad GUI or IxLoad Tcl API testing, all but one of the chassis base addresses will need to be changed.

Note that the Ixia ports on a chassis will use only a limited range of addresses on their subnet. For example, if the base address is 10.0, and there are sixteen 8-port cards in the chassis, then the range of addresses used will be:

10.0.1.1 - 10.0.16.8

To change the base address of a chassis, use IxExplorer:

1. Open IxExplorer.
2. Select the Chassis Chain object in the tree and right click and choose Add Chassis. Enter the name or IP address of the chassis that will be used.
3. Right-click on the newly created chassis and select Properties.
4. Select the IxRouter tab.
5. You may change the base address in the *IP Network* field. Make sure to only modify the top two octets and do not change the *Mask* field.

## Backward Compatibility

IxLoad Tcl provides backward compatibility for:

- Scripts that configure and run tests.
- Scripts that run tests from a repository.
- Scripts that modify repositories, as long as the script was written for and tested with repositories from the same IxLoad release as the script, or an earlier release.

For example, if you write a script for IxLoad 4.0, that script can modify any repository created in IxLoad 4.0 or earlier.

IxLoad Tcl *does not* provide backwards compatibility for scripts that modify repositories that were created or saved from releases after the release that the script was written for and tested on.

For example, if you write a script for IxLoad 4.0, that script *should not* modify a repository created in a release later than IxLoad 4.0.

## Deprecated Commands

The following items are no longer supported:

- Agent sharing

In previous releases, the Tcl API allowed sharing of objects between NetTraffics. For example, in the following code fragment, Traffic1 is shared between two NetTraffics:

```
$Traffic1_Network3 config \  
-traffic [$Traffic1_Network1 cget -traffic]
```

Beginning with the 5.30 release, agents can no longer be shared. If you try to run a script that includes agent sharing, an error will be thrown and the script will stop.

Instead of agent sharing, the Tcl API includes a new command, `duplicate`, that makes copies of networks, traffics (agents) and DUTs. The following example shows `duplicate` being used to copy agents from Traffic1 to Traffic3:

```
set Traffic1 [$Traffic1_Network1 cget -traffic]  
set Traffic3 [$Traffic1 duplicate]  
$Traffic1_Network3 config \  
-traffic $Traffic3
```

`duplicate` is described in [duplicate](#).

## Python Support

In addition to Tcl, you can create native Python scripts that run IxLoad tests. You can either write the Python scripts by hand, or you can use ScriptGen to create a Python script natively from an existing test configuration. For more information on using ScriptGen, see the *IxLoad User Guide*.

**Note:** Python is not included with the IxOS or IxLoad installers. You need to install Python separately before you can run Python scripts.

### Configuring Python Support

When you install IxOS Tcl support for Linux, python wrappers are also installed. On the following path:

```
<IxOsTclInstallationPath>/bin
```

an `ixpython` file is installed.

You need to edit this file to specify the python properties:

1. Open the `ixpython` file, and edit the following lines:

<code>PYTHON_HOME=</code>	Python install directory. Usually, this is <code>/usr/bin</code> .
<code>PYTHONver=</code>	Python version. Example: <code>PYTHONver=2.7</code>
<code>PYTHONLibPath=</code>	IxLoad path, including version. Example: <code>PYTHONLibPath=\$IXIA_HOME/lib/IxLoad6.60.0.109-EB</code>

2. Save the file.

3. To run a python script, type:

```
ixpython <pythonScript>
```

#### Python Commands

All the commands that are available in Tcl are also available in Python. In most cases, you use the same command, but written in Python syntax.

However, there are some Python-specific commands. These are listed in the table below.

There are two sample Python scripts installed with IxLoad that you can use as examples of how to write an IxLoad Python script. They are installed on the following path:

```
<ixload_install_path>\<version>\PythonScripts\Samples
```

The following table describes the Python-specific IxLoad commands.

Python Command	Description
<b>Equivalents to ::IxLoad</b>	
<code>IxLoad.connect(remoteServer)</code>	Connect to a remote Tcl Windows server when running from a non-Windows client. Tcl equivalent: <code>::IxLoad connect</code> Example: <pre>IxLoad = IxLoad() IxLoad.connect 10.200.55.39</pre>
<code>IxLoad.new</code>	Create a new object. Tcl equivalent: <code>::IxLoad new</code> Example: <pre>logger = IxLoad.new("ixLogger", logtag, 1)</pre>
<code>IxLoad.loadAppPlugin(plugin)</code>	Load a plugin. Tcl equivalent: <code>\$ixAppPluginManager load "HTTP"</code> Example: <pre>IxLoad.loadAppPlugin("HTTP")</pre>
<code>IxLoad.delete(element)</code>	Delete an element of an IxLoad test. Tcl equivalent: <code>::IxLoad delete</code> Example: <pre>IxLoad.delete(chassisChain)</pre>

IxLoad.disconnect()	<p>Disconnect from the remote server.</p> <p>Tcl equivalent: <code>::IxLoad disconnect</code></p> <p>Example:</p> <pre>IxLoad = IxLoad() IxLoad.connect 10.200.55.39 ... IxLoad.disconnect()</pre>
IxLoad.waitForCaptureDataReceived()	<p>Wait for the data capture (for Analyzer application) to finish.</p> <p>Tcl equivalent: <code>vwait ::ixCaptureMonitor</code></p> <p>Example:</p> <pre>IxLoad.waitForCaptureDataReceived()</pre>
IxLoad.waitForTestFinish()	<p>Wait for the test to finish.</p> <p>Tcl equivalent: <code>vwait ::ixTestControllerMonitor</code></p> <p>Example:</p> <pre>IxLoad.waitForTestFinish()</pre>
<b>Equivalents to statCollectorUtils</b>	
StatUtils.Initialize(test_server_handle)	<p>Initialize the statistics collection utilities.</p> <p>Tcl equivalent: <code>\$(NS)::Initialize</code></p> <p>Example:</p> <pre>test_server_handle= e=testController.getTestServerHandle() StatUtils.Initialize(test_server_handle)</pre>
StatUtils.ClearStats()	<p>Clear the statistics from a previous test run.</p> <p>Tcl equivalent: <code>\$(NS)::ClearStats</code></p> <p>Example:</p> <pre>StatUtils.ClearStats()</pre>
StatUtils.AddStat()	<p>Add a statistic to the list of statistics to be collected.</p> <p>Tcl equivalent: <code>\$(NS)::AddStat</code></p> <p>Example:</p> <pre>StatUtils.AddStat(caption = "Watch_Stat_1", statSourceType = "HTTP Client", statName = "HTTP Bytes Sent", aggregationType = "kSum", filterList = {})</pre>



StatUtils.StartCollector()	<p>Start collecting statistics.</p> <p>Tcl equivalent: <code>\${NS}::StartCollector -command ::my_stat_collector_command</code></p> <p>Example:  <code>StatUtils.StartCollector(my_stat_collector_python_command)</code></p>
StatUtils.StopCollector()	<p>Stop collecting statistics.</p> <p>Tcl equivalent: <code>\${NS}::StopCollector</code></p> <p>Example:  <code>StatUtils.StopCollector()</code></p>
<b>Enums</b>	
IxLoad.<element>.<enum>	<p>Change an enumerated value.</p> <p>Tcl equivalent: <code>`\${NS}::&lt;element&gt;(enum)</code></p> <p>Example:  <code>svr_network.networkRangeList.appendItem(name = "svr_range", enable = 1, firstIp = "198.18.200.1", \ ipIncrStep = IxLoad.ixNetworkRange.kIpIncrOctetForth, ...)</code></p>

## PERL Support

In addition to Tcl, you can create native Perl scripts that run IxLoad tests. You can either write the Perl scripts by hand, or you can use ScriptGen to create a Perl script natively from an existing test configuration. For more information on using ScriptGen, see the *IxLoad User Guide*.

Perl support, including the Perl interpreter and supporting modules, are automatically installed when you install IxLoad. IxLoad Perl modules are installed the following location: `C:\Program Files (x86)\Ixia\Perl`.

### Sample Scripts

Sample Perl scripts are installed in `<ixload_install_path>\PerlScripts\Samples`. You can review these scripts to help you in creating your own scripts, or you can edit them to reflect your specific configuration (chassis IP address, card IDs, port IDs, etc.) and run them.

### Running Scripts

To run an IxLoad Perl script:

- If your script is on the path `<ixload_install_path>\PerlScripts\Samples`, you can run a script with the command `perl <script_name>.pl`.
- If your script is on a different path, add the following line to the script header, so that it finds the path the IxLoad build that it should use:

```
use lib '<ixload_install_path>/version/PerlScripts/lib';
```

For example:

```
use warnings;
use strict;
use lib '.';
...
use lib 'C:/Program Files (x86)/Ixia/IxLoad/6.70.0.56-EB/PerlScripts/lib';
use IxLoad;
```

#### Perl Commands

All the commands that are available in Tcl are also available in Perl. In most cases, you use the same command, but written in Perl syntax.

However, there are some Perl-specific commands. These are listed in the table below.

Perl Command	Description
<b>Equivalents to ::IxLoad</b>	
<code>IxLoad.connect(remoteServer)</code>	Connect to a remote Tcl Windows server when running from a non-Windows client. Tcl equivalent: <code>::IxLoad connect</code> Example: <code>use IxLoad;</code> <code>IxLoadConnect-&gt;connect('1.2.3.4');</code>
<code>IxLoad.new</code>	Create a new object. Tcl equivalent: <code>::IxLoad new</code> Example: <code>my \$logger = IxLoad-&gt;new('ixLogger', \$logtag, 1);</code>
<code>IxLoad.loadAppPlugin(plugin)</code>	Load a plugin. Tcl equivalent: <code>\$ixAppPluginManager load "HTTP"</code> Example: <code>IxLoad-&gt;pluginManager('load', 'HTTP');</code>

IxLoad.delete(element)	Delete an element of an IxLoad test. Tcl equivalent: ::IxLoad delete <b>Example:</b> IxLoad->delete(\$chassisChain);
IxLoad.disconnect()	Disconnect from the remote server. Tcl equivalent: ::IxLoad disconnect <b>Example:</b> use IxLoad;IxLoadConnect->connect ("10.200.25.39");...IxLoad->disconnect();
IxLoad.waitForCaptureDataReceived() ( )	Wait for the data capture (for Analyzer application) to finish. Tcl equivalent: vwait ::ixCaptureMonitor <b>Example:</b> IxLoad->waitForCaptureDataReceived();
IxLoad.waitForTestFinish()	Wait for the test to finish. Tcl equivalent: vwait ::ixTestControllerMonitor <b>Example:</b> IxLoad::TestControllerWait();
<b>Equivalents to statCollectorUtils</b>	
StatUtils.Initialize(test_server_handle)	Initialize the statistics collection utilities. Tcl equivalent: \${NS}::Initialize <b>Example:</b> my \$test_server_handle = \$testController->getTestServerHandle();\$NS->Initialize(\$test_server_handle);
StatUtils.ClearStats()	Clear the statistics from a previous test run. Tcl equivalent: \${NS}::ClearStats <b>Example:</b> \$NS->ClearStats();
StatUtils.AddStat()	Add a statistic to the list of statistics to be collected. Tcl equivalent: \${NS}::AddStat <b>Example:</b> \$NS->AddStat({ filterList => {}, caption => "Watch_Stat_1", statSourceType => "HTTP Client", statName => "HTTP Bytes Sent", aggregationType => "kSum"});

StatUtils.StartCollector()	<p>Start collecting statistics.</p> <p><b>Tcl equivalent:</b> <code>\${NS}::StartCollector -command ::my_stat_collector_command</code></p> <p><b>Example:</b></p> <pre>\$NS-&gt;StartCollector({command =&gt; \&amp;my_stat_collector_command});</pre>
StatUtils.StopCollector()	<p>Stop collecting statistics.</p> <p><b>Tcl equivalent:</b> <code>\${NS}::StopCollector</code></p> <p><b>Example:</b> <code>\$NS-&gt;StopCollector();</code></p>
<b>Enums</b>	
IxLoad.<element>.<enum>	<p>Change an enumerated value.</p> <p><b>Tcl equivalent:</b> <code>\$.:&lt;element&gt;(enum)</code></p> <p><b>Example:</b></p> <pre>\$svr_network-&gt;networkRangeList-&gt;appendItem({ name =&gt; "svr_range",    enable =&gt; 1,    firstIp =&gt; "198.18.200.1",    ipIncrStep =&gt; \$IxLoad::Info::ixNetworkRange{kIpIncrOctetForth},...});</pre>

*Examples*

Below are some examples of functions written in TCL and in Perl, for comparison.

	Tcl	Perl
<b>Creating an object</b>	<code>set chassisChain [::IxLoad new ixChassisChain]</code>	<code>my \$chassisChain = IxLoad-&gt;new ("ixChassisChain");</code>
<b>Calling a method</b>	<code>\$chassisChain addChassis 10.215.170.83</code> <code>-- or --</code> <code>\$Network1 portList.appendItem \-chassisId 1 \-cardId 2 \-portId 1</code>	<code>\$chassisChain-&gt;addChassis ("10.215.170.83");</code> <code>-- or --</code> <code>\$Network1-&gt;portList-&gt;appendItem({ chassisId =&gt; 1, cardId =&gt; 2, portId =&gt; 1});</code>
<b>Setting properties on an object</b>	<code>\$Settings_1 config \-teardownInterfaceWithUser false \-Stale false \-interfaceBehavior 0</code>	<code>\$Settings_1-&gt;config({teardownInterfaceWithUser =&gt; "False", _Stale =&gt; "False", interfaceBehavior =&gt; 0});</code>

! 2

This page intentionally left blank.

## Quick Start

This section describes how to modify a sample script to run an IxLoad Tcl API test. You can use this section to quickly familiarize yourself with the basic steps required to run a simple IxLoad script. Once you have modified and run a sample script, you can refer to the following sections in this guide to learn about the IxLoad Tcl API in greater detail.

- To run a sample script from Windows, see Windows (see "[Windows](#)").
- To run a sample script from Unix/Linux, see Unix/Linux (see "[Unix/Linux](#)").

## Windows

The section describes how to run a sample Tcl script included with IxLoad on Windows. To run IxLoad Tcl scripts, you must install the IxLoad Tcl 8.4 shell, which is an option in the IxLoad Windows client installation package.



**Note:** The IxOS wish console cannot be used to execute IxLoad Tcl scripts.

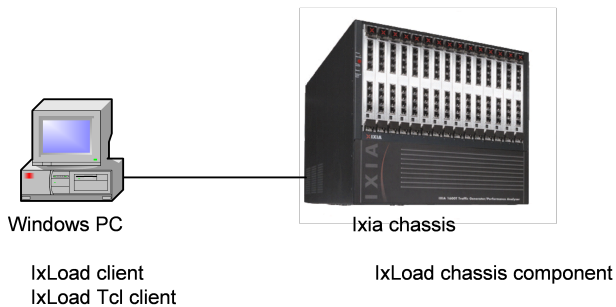

## Using The Sample Tcl Scripts

The Tcl scripts require either the IxLoad Tcl 8.4 wish console or the Tcl shell to run. Choose one of the following:

- Double-click the IxLoad Wish shell icon for the version of IxLoad that you want to run
- Execute the following in a console window: C:\Program Files\Ixia\Tcl\<version>\bin\tclsh.exe, and then source IxiaWish.tcl from C:\Program Files\Ixia\IxLoad\<version>\TclScripts\bin.

The included sample Tcl scripts can be found in the following subdirectories under C:\Program Files\Ixia\IxLoad\<version>\TclScripts\Samples:

- Samples\Application Features contains scripts that demonstrate various IxLoad features
- Samples\Network contains scripts that create various network configurations
- Samples\Protocols contains scripts that generate different types of protocol traffic
- Samples\Stats contains scripts that demonstrate how to retrieve statistics

One script from the Samples directory, `setup_simple.tcl`, must be modified to work with your network topology. See [Editing the setup\\_simple.tcl script](#) (see "[Editing the setup\\_simple.tcl script](#)").



**Note:** When you source the **IxiaWish.tcl** script, it sets the `auto_path` value so that when you execute a `package req IxLoad` command, the Tcl shell can find the IxLoad packages.

## Editing the setup\_simple.tcl script

You must edit the `setup_simple.Tcl` script to include the correct addresses in use on your network.

- On Windows, the file is located at : ..\IxLoad\<version>\TclScripts\Samples
- On Unix/Linux, the file is located at: ../IxLoadTclApi<version>/Samples/

To edit the `setup_simple.tcl` script:

1. In an editor, open the `setup_simple.tcl` script.
2. Set the Tcl server address:

```
variable ::IxLoadPrivate::SimpleSettings::remoteServer n.n.n.n
```

Tcl server must run on a Windows host, not on the chassis. When running a script from Unix, change this value to the IP address of the IxLoad client that the script will run on. When running a script from Windows, this variable must still be set, but its value is not used.

3. Set `chassisName` to the hostname or IP address of the chassis you will use:

```
variable ::IxLoadPrivate::SimpleSettings::chassisName n.n.n.n
```

4. `CARD_ID` and `PORT_ID` are local variables used between the `setup_simple.tcl` script and all Ixia-provided sample Tcl scripts. Set `CARD_ID` and `CARD_PORT` (in the `serverPort` and `clientPort`



array) to the card and port you will use:

```
array set ::IxLoadPrivate::SimpleSettings::clientPort {
CARD_ID"4"

PORT_ID"5" }
array set ::IxLoadPrivate::SimpleSettings::serverPort {CARD_ID      "3"PORT_ID
"2" }
```

5. Save and close the file.

## Running the sample scripts

Follow the instructions below to launch the ixwish shell, and call the Tcl script. In the procedure below, replace (replace <version> with the correct directory name).

To run a sample script:

1. Choose one:
  - Double-click the IxLoad Wish shell icon for the version of IxLoad that you want to run
  - Execute the following in a console window: C:\Program Files\Ixia\Tcl\<version>\bin\tclsh.exe, and then source IxiaWish.tcl from C:\Program Files\Ixia\IxLoad\<version>\TclScripts\bin.
2. Change the path to the directory that contains the script that you want to run. Scripts are stored in directories under <installDir>/IxLoad/<version>/TclScripts/Samples.
  - Samples/Application Features contains scripts that demonstrate various IxLoad features
  - Samples/Network contains scripts that create various network configurations
  - Samples/Protocols contains scripts that generate different types of protocol traffic
  - Samples/Stats contains scripts that demonstrate how to retrieve statistics

For example, to change to the Protocols directory, type:

```
cd Samples/Protocols
```

3. To start the script, use the `source` command to run it.

For example, to run the HTTP.tcl script, type

```
source HTTP.tcl
```

## Monitoring Status and Retrieving Results

While a test is running, status messages display in the wish console window.

The results (in CSV format) are placed in the `Results\<Tclscriptname>` subfolder where your Tcl script is located.

For example: C:\Program Files\Ixia\IxLoad\<version>\Results\simplehttpclientandserver

During the test run, a log file is created and stored in the current working directory.

## Unix/Linux

On Unix/Linux, two types of installers are available: .bin and PIT. The .bin installers automatically install all the required dependent packages on the following paths:

IxLoad	/opt/ixia/ixload/version/
IxOS-API	/opt/ixia/ixos/version/
TCL	/opt/ixia/TCL/version/
Python	/opt/ixia/Python/version
Perl	/opt/ixia/Perl/version

For the PIT installer, an equivalent dependencies bundle is available.

There are a number of IxLoad Tcl .bin installers available for Unix/Linux; use the version appropriate for your distribution:

<b>IxLoad Tcl Client Installation File</b>	<b>Description</b>
IxLoadTclAPI<version>linux.bin	Fedora Core 14, RedHat Enterprise 5.0
IxLoadTclAPI<version>linux_x64.bin	64-bit version of supported Linux distributions
IxLoadTclAPI<version>FreeBSD.bin	FreeBSD 6.3

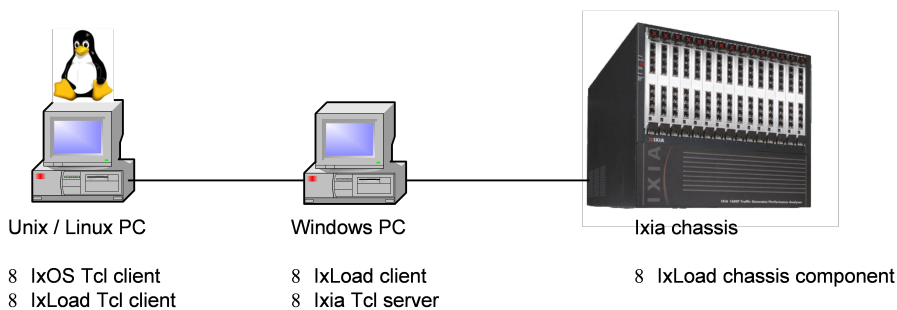

## Unix/Linux:

See the [Installing IxLoad Tcl](#)

## Windows PC:

Install IxLoad on the Windows PC and select the optional Tcl components during installation.

Install IxOS with the Client and Tcl Server options.

## Ixia chassis:

Install the IxLoad IxOS chassis components as for normal IxLoad installation.

## Installing IxLoad Tcl

This section describes how to install the Unix/Linux version of IxLoad Tcl.

**NOTE**

In addition to installing IxLoad on Unix/Linux using the Java-based installer, you can also install it using tarballs. See [Installing IxLoad Tcl with Tarballs](#).

**NOTE**

You must login as root when you install IxLoad Tcl. Also, ensure that you reboot the system after installation so that the new environment variables take effect.

To install Unix/Linux IxLoad Tcl:

1. Copy the `IxLoadTclAPI<version>Linux.bin` file to the Linux system.
2. Change the attribute to make it executable.  
Example: `chmod +x IxLoadTclAPI<version>Linux.bin`
3. Execute the installer file. If your Linux version supports a Graphical User Interface (GUI), use the `-gui` option. Otherwise, the installer will run in console mode.  
Example (console mode): `./IxLoadTclAPI<version>Linux.bin`  
Example (GUI mode): `./IxLoadTclAPI<version>Linux.bin -gui`
4. Follow the prompts to complete the installation.  
The default installation path is `/opt/ixia/ixload/IxLoadVersion/`.
5. Reboot the system so that the environment variables added by the installer can take effect.

## Installing IxLoad Tcl with Tarballs

As an alternative to the Java-based Unix/Linux installer, Ixia also provides the IxLoad Unix/Linux Tcl files as tarballs. The tarball installer provides a more flexible solution to installing and running IxLoad Tcl scripts.

**NOTE** The tarball installer requires the `comm v4.x` third-party library to be installed before you install IxLoad Tcl.

**NOTE** You must login as root when you install IxLoad Tcl. Also, ensure that you reboot the system after installation so that the new environment variables take effect.

**NOTE** If you intend to write Python scripts, you should:

1. Install your own Python2x version along with the `tkinter` library.
2. After installing Python, change the `PYTHONBinPath` environment variable so that it points to the Python2x version that you installed (by default it points to `ixpython`).

To install Unix/Linux IxLoad Tcl Using Tarballs:

1. Unpack `IxLoadTclApi_<version>.tar` file.
2. Set the environment variable `IXLOAD_IXLOADFULLVERSION_INSTALLDIR` to the path to where the `stackManagerStaticClasses.tcl` file is located.
  - `stackManagerStaticClasses.tcl` is located in the same folder as the `IxLoad.tcl` file (`<INSTALL_DIRECTORY>/lib/IxLoad/`).
  - `IXLOADFULLVERSION` is the complete IxLoad version number, with the major, minor, branch, and build numbers separated by underscores (`_`).

For example, a sample environment variable might be: `IXLOAD_5_10_151_20_INSTALLDIR=/home/ixload5.10.ea/lib/ixload/`

You can lookup the the exact name of the environment variable by searching the `IxLoad.tcl` file for the string `IXLOAD_X_Y_`, where X and Y are the major and minor version numbers. For example, `IXLOAD_5_10_`

3. Reboot the system so that the environment variables added by the installer can take effect.

## Editing the `setup_simple.tcl` script

You must edit the `setup_simple.Tcl` script to include the correct addresses in use on your network.

- On Windows, the file is located at : `..\IxLoad\<version>\TclScripts\Samples`
- On Unix/Linux, the file is located at: `../opt/ixia/ixload/IxLoadVersion/Samples/`

To edit the `setup_simple.tcl` script:

1. In an editor, open the `setup_simple.tcl` script.
2. Set the Tcl server address:

```
variable ::IxLoadPrivate::SimpleSettings::remoteServer n.n.n.n
```

Tcl server must run on a Windows host, not on the chassis. When running a script from Unix, change this value to the IP address of the IxLoad client that the script will run on. When running a script from Windows, this variable must still be set, but its value is not used.

3. Set `chassisName` to the hostname or IP address of the chassis you will use:

```
variable ::IxLoadPrivate::SimpleSettings::chassisName n.n.n.n
```

- CARD\_ID and PORT\_ID are local variables used between the setup\_simple.tcl script and all Ixia-provided sample Tcl scripts. Set CARD\_ID and CARD\_PORT (in the serverPort and clientPort array) to the card and port you will use:

```
array set ::IxLoadPrivate::SimpleSettings::clientPort {
CARD_ID"4"
PORT_ID"5" }
array set ::IxLoadPrivate::SimpleSettings::serverPort {CARD_ID      "3"PORT_ID
"2" }
```

- Save and close the file.

## Running the sample scripts

Once the setup\_simple.tcl script is configured, use the following procedure to launch the Tcl shell and run a sample script.

To run a sample script:

- Change to the bin directory where IxOS Tcl is installed.
- Copy /bin/ixwish to bin/ixTclsh.
- Start the Tcl shell:

```
./bin/ixTclsh
```

- Scripts are stored in directories under /etc/ixosTcl8.4/IxLoadTclAPI<version>/Samples.
  - Samples/Application Features contains scripts that demonstrate various IxLoad features
  - Samples/Network contains scripts that create various network configurations
  - Samples/Protocols contains scripts that generate different types of protocol traffic
  - Samples/Stats contains scripts that demonstrate how to retrieve statistics

Change your path to the directory that contains the script that you want to run.

For example, to change to the Protocols directory, type:

```
cd /etc/ixosTcl8.4/IxLoadTclAPI<version>/Samples/Protocols
```

- Source the sample script that you want to run. For example, to run the HTTP.tcl script, type:

```
source HTTP.tcl
```

## Monitoring Status and Retrieving Results

While a test is running, status messages display in the Linux shell.

The log files are stored on the Windows host. The log file name is determined by the set LogName command in the script.

- If you specify no path or a partial path, the log file is stored relative to the \remoteScriptingService directory on the IxLoad installation path.
- If you specify an absolute path, the log file is stored in that location.

The log file will be prefixed with the specified name, followed by "-x-00" where x is a session ID from 1 through 4. The sample scripts all set the log name to be the same as the script name. For example:

```
C:\Program Files\Ixi-  
a\IxLoad\<version>\TclScripts\remoteScriptingService\RESULTS\<scriptname>
```

## API Overview

An IxLoad test consists of one or more Client Communities sending traffic through the DUT (Device Under Test) to Server Communities. The structure of both a client and server community is the same: Traffic sent over a network. Traffic is generated or handled by one or more agents.

The conceptual view of an IxLoad test is shown in the figure below.

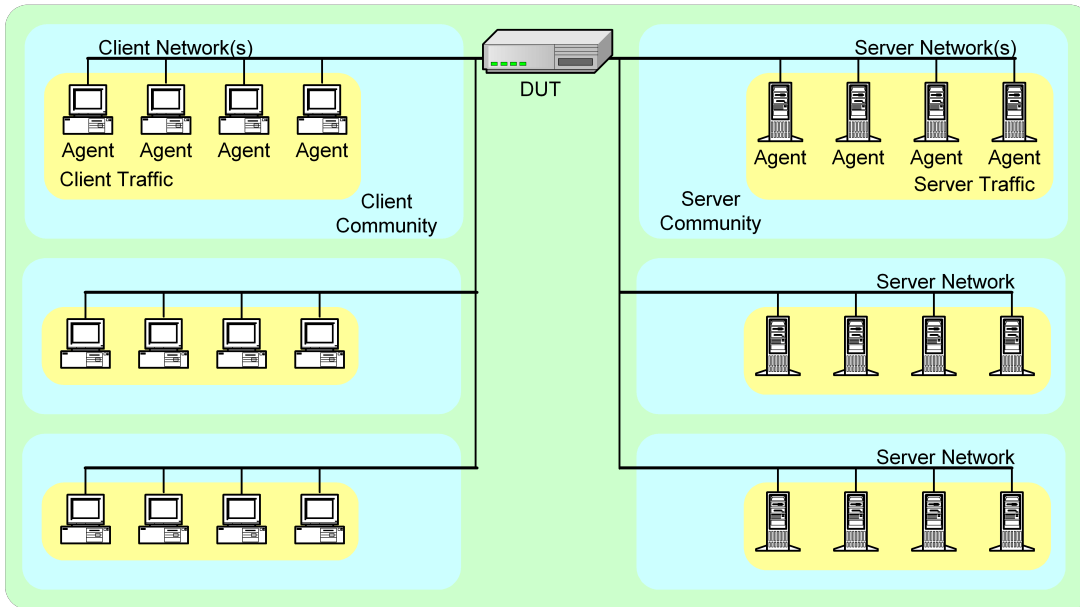

## Tcl API Structure

The Tcl API's main components are shown in the figure below.

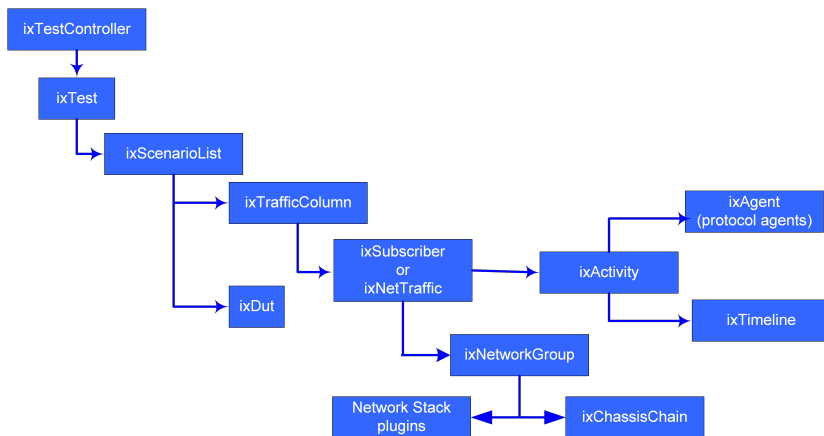

The table below describes the components of the API shown in the figure.

Component	Description
ixTestController	testController controls the running of a test. No test can run successfully without this object. It has no relationship with any other object. To run the test, you pass <code>run &lt;test variable name&gt;</code> to the test controller command.
ixTest	The top level object which co-ordinates the client and server communities. It holds separate lists of each type of communities.
ixScenario	This object represents the traffic flow (as shown in the GUI). There can be multiple traffic flows. The traffic flows are referenced through the <code>scenarioList</code> sub-object of an <code>ixTest</code> object.
ixTrafficColumn	This is a container of <code>ixNetTraffic</code> , <code>ixSubscriber</code> , and <code>ixDut</code> objects. This is accessed through the <code>columnList</code> element of an <code>ixScenario</code> object.
ixNetTraffic	This object joins a network configuration to a traffic configuration. This object is accessed through an index into the <code>columnList</code> of an <code>ixScenario</code> object.
ixNetworkGroup	This object describes a network configuration that is unique within the test. This object is accessed through the <code>network</code> element of an <code>ixNetTraffic</code> object.



ixActivity	This object configures the high-level properties that are common to all agents, such as the timeline, and the test objective type and value. Activities are accessed through an index into the <code>activityList</code> of an <code>ixNetTraffic</code> or <code>ixSubscriber</code> object.
ixAgent	The <code>ixAgent</code> elements generate and handle protocol specific traffic. Some client agents use Protocol Actions to describe their operation. Agent configuration can be accessed through the <code>ActivityList</code> of the <code>ixNetTraffic</code> and <code>ixScenario</code> objects
Network Stack plugins	Protocol and associated extensions that provide the network that the traffic protocols run over.
Protocol Actions	Some of the Protocol Agents describe their operation in terms of specific actions. These protocol dependent objects detail those operations.
ixChassisChain	This independent object describes the list of chassis that will be used in a test.
ixDut	This object holds the type and type-specific information about a DUT.
ixTimeline	This object configures the time in the test when the activities in the <code>NetTraffics</code> come online, and how long they stay up for. It is also used to configure the test's objectives.
ixSubscriber	The <code>ixSubscriberNetTraffic</code> object is a special type of <code>NetTraffic</code> that simulates the traffic patterns created by residential customers that receive voice, video, and data service (Triple-play) over a single physical connection (usually a cable or DSL connection).
ixImpairment	The <code>ixImpairment</code> object impairs one or more types of traffic from a client and server network.
activityList	Generates traffic for one side of a particular protocol.

## Mandatory Objects to Complete a Script

The following mandatory objects are required to complete a script:

- an `ixTestController`
- an `ixRepository` or an `ixChassisChain` (`ixRepository` includes a chassis chain)
- `ixViewOptions`
- `ixTest`

- ixTrafficFlow
- ixTrafficColumn
- ixNetTraffic
- ixTimeline
- activityList

## Multi Version Support

You can install and use multiple versions of IxLoad on the client PC and on the chassis. Installing multiple versions allows you to try out the new features in a new release of IxLoad without having to overwrite your existing copy of IxLoad.

Refer to API Quick Start and Running an IxLoad Tcl Program for more information.

## General API Conventions

IxLoad's Tcl API is somewhat different from other Ixia Tcl APIs that you might have used. Rather than a single set of global commands that are associated with an Ixia port, IxLoad uses the concept of instances of commands—called *objects*. This guide uses the words *command* and *object* to refer to the same thing.

## Objects

This section describes how to work with objects in the IxLoad Tcl API.

IxLoad represents every object with a Tcl command. When you create an object, you receive a command that must then be used with subcommands to modify the object.

Similarly, when you retrieve a property of an object that is itself an object, you can use subcommands to manipulate that sub-object. Generally, it is better to save the sub-objects in a Tcl variable instead of retrieving them repeatedly. This is because every time you retrieve it, you receive a different command (though they reference the same underlying object).

Every object command should also be deleted as described in the next section.

## Object Creation and Destruction

The general paradigm for the creation of IxLoad objects is to make a 'new' copy of a command, saving the result in a Tcl variable:

```
set my_network [::IxLoad new ixClientNetwork $chain\  
-name "my_client_network4" ]
```

The variable `my_network` is an instance of the `ixClientNetwork` object. Each instance occupies its own area of memory. Multiple objects of the same type can be created and added to lists of items.

The `::IxLoad` reference is to a utility routine that allows new objects of any type to be created. The `::` means in the global context and is a safe means of referring to `ixLoad` from any program location.

The `ixLoad` command provides a convenient means of creating an object and set its options at the same time. One need only append option names and values to the end of the command. See the following example:

```
set my_network [::IxLoad new ixClientNetwork \
-name "my_client_network4"
```

This is the standard means by which `IxLoad` objects are created.

When an object is no longer needed, its command should be destroyed as shown in the following example:

```
::IxLoad delete $my_network
```

After a command is destroyed, it can no longer be used. If it is a sub-object, then the object can be accessed again by fetching a new command from the original object.

## Subcommands

### Synopsis

```
$anyIxLoadObject subcommand options...
```

Each option is a name/value pair, with the name preceded by a hyphen (-).

The return value is of a type appropriate for the option. If the option is a sub-object, the return value will be a command representing that object. Otherwise, it will be a simple string value (though the string may represent a built-in value, such as an INT).

### Common subcommands

In addition to command/object-specific subcommands, each `IxLoad` command/object supports a set of subcommands described in the following table.

Subcommand	Usage
<code>config</code>	Allow any option of the command to be set.
<code>cget</code>	Read the value of any command option.
<code>getOptions</code>	Get the names of all of a command's options.

### **cget option**

This subcommand is used to obtain the current value of any option. The `option` must begin with a hyphen (-). The return value is of a type appropriate for the option.

### **config option value option value...**

The `config` subcommand may be used to set the value of one or more options in a command. The `option` must begin with a hyphen (-). The `value` must be of a type appropriate for the option.

### **getOptions**

This subcommand returns a Tcl list with all of the options available for a command/object including an initial hyphen for each option.

### **EXAMPLE**

```
$object cget -name$object config -name "media" -value "mp3"set optionList [$object getOptions]
```

## **Subobjects**

Some IxLoad objects can contain other objects, making them *subobjects*.

The type of the sub-object will be described under the documentation for the sub-object. For example, the following code fetches a sub-object into a command, and then invokes a subcommand on the resulting sub-object:

```
set $my_network [$my_nettraffic cget -network]$my_network config -name network1
```

If you only need to access a single property of a sub-object, you can avoid storing the command for the sub-object in a separate variable by using the 'dot' (.) notation. For example, for the `name` option in `ixClientNetwork`, you can reference the subobject's option as follows:

```
$my_nettraffic network.config -name lk_hosts
```

In this case, `network.config` causes the `config` subcommand of the `network` sub-object to be called with the desired options.

The sub-command can be preceded by more than one sub-object, much like a directories can be nested to create a path of sub-directories.

## Lists of Objects

### Synopsis

If you know the index of an item in a list, it may be directly manipulated by the common configuration commands listed in the table under Object Creation (see "[Object Creation and Destruction](#)"). For example, to configure the first item in a list:

```
$my_netTraffic traffic.agentList(0).config -name httpAgent
```

Note that the preceding example also shows that an element of a list can be a sub-object in a path leading to a subcommand.

Most IxLoad commands contain one or more options that are lists of other objects. For example, `networkRangeList` in `ixClientNetwork` is a list of items of type `ixNetworkRange`. Such lists are commonly built up using the `appendItem` subcommand. For example:

```
$my_network portList.appendItem \  
-chassisId 1 \  
-cardId 2 \  
-port 3
```

As in the `::IxLoad new` command, you can set the values of a list member's options while creating the item. All such lists have a number of associated sub-commands, described in the following table.

Subcommand	Usage
<code>clear</code>	Remove all elements from the list.
<code>appendItem</code>	Add an item to the end of the list.
<code>configItem</code>	Configure the options of one item of the list.
<code>deleteItem</code>	Delete an item from the list.
<code>getItem</code>	Return an instance reference to an element of a list. This can be used to directly manipulate that list member.
<code>insertItem</code>	Add an item into the middle of the list.
<code>find</code>	Search for an item in a list. The indexes of all matching list members is returned.
<code>indexCount</code>	Returns a count of the number of items in a list.

## SUBCOMMANDS

The following subcommands are available to handle options. Except where noted, no value is returned; an exception is raised in the case of an error. In all cases where they are used the `option` must begin with a hyphen (-). The `value` must be of a type appropriate for the option.

### **appendItem** `option value option value...`

The `appendItem` subcommand may be used to add an item to a list. Any number of options in the listed item may be set as part of the append.

### **configItem** `index option value option value...`

The `configItem` subcommand may be used to configure a particular item in a list. Any number of options in the list item may be set. The `index` argument is used to indicate which item in the list is to be configured.

### **clear**

The `clear` subcommand may be used to delete all listed items from a list.

### **deleteItem** `index`

The `deleteItem` subcommand may be used to delete a listed item from a list. The `index` argument is used to indicate which item in the list is to be configured.

### **find** `mode option value option value...`

The `find` subcommand may be used to search a list for matching criterion. The `mode` argument may be one of:

Option	Usage
<code>exact</code>	Match the <code>value</code> fields exactly.
<code>regexp</code>	Use regular expressions in the matching.
<code>uppercase</code>	Perform a caseless match.

Any number of options may be used in the match. The `find` subcommand searches for all items in the list, whose keyworded options match the values. A list of indexes of matching items is returned.

### **getItem** `index`

Unsorted lists: The `getItem` subcommand may be used to retrieve an item from a list. The `index` argument is used to indicate which item in the list is to be retrieved. This subcommand returns the object from the list.

Sorted lists: The `getItem` subcommand may be used to retrieve an item from a list. The `name` argument is used to indicate which item in the list is to be retrieved. This subcommand returns the object from the list.

## indexCount

The `indexCount` subcommand returns the number of objects in the list.

## insertItem index option value option value...

The `insertItem` subcommand may be used to insert an item in a list. Any number of options in the list item may be set. The `index` argument is used to indicate the insertion point in the list. The new item will be inserted before the `index`'th item in the list.

## Constants

Predefined constants within the IxLoad Tcl API are associated with particular commands and placed in an array corresponding to a command. For example, the `ixCard` object holds a definition for different Ixia card types, one of which is `kCard1000Txs4`. The proper means of referencing this constant is: `$::ixCard(kCard1000Txs4)`

Text strings may frequently be set using provided strings. Refer to the various reference pages to determine availability.

## Strings and Numbers

Tcl variables are considered type-less. That is, no special distinction is made between the string of characters "1.0" and the numeric value 1.0. Within the IxLoad Tcl API, however, items that look like numbers (for example, 111) are converted to numbers. In the specification of arguments and values to the IxLoad Tcl APIs, it is best to enclose these items in quotes if they are not to be interpreted as numbered values.

For example, if you want to name an IxLoad element 123, you should enclosed the name in quotes: "123".

## TCL API Internal Overview

The following sections provide an overview of how the Tcl API functions on Windows or Unix/Linux platforms.

## Windows Overview

When running scripts on Windows:

- For IxLoad Unit Limit:
- User Interface counts as two
- Scripts count as one
- TCL Server is not required
- The `:IxLoad connect/disconnect` command is ignored
- Log files are stored in the same directory as the script
- Relative files depend on the Client directory path

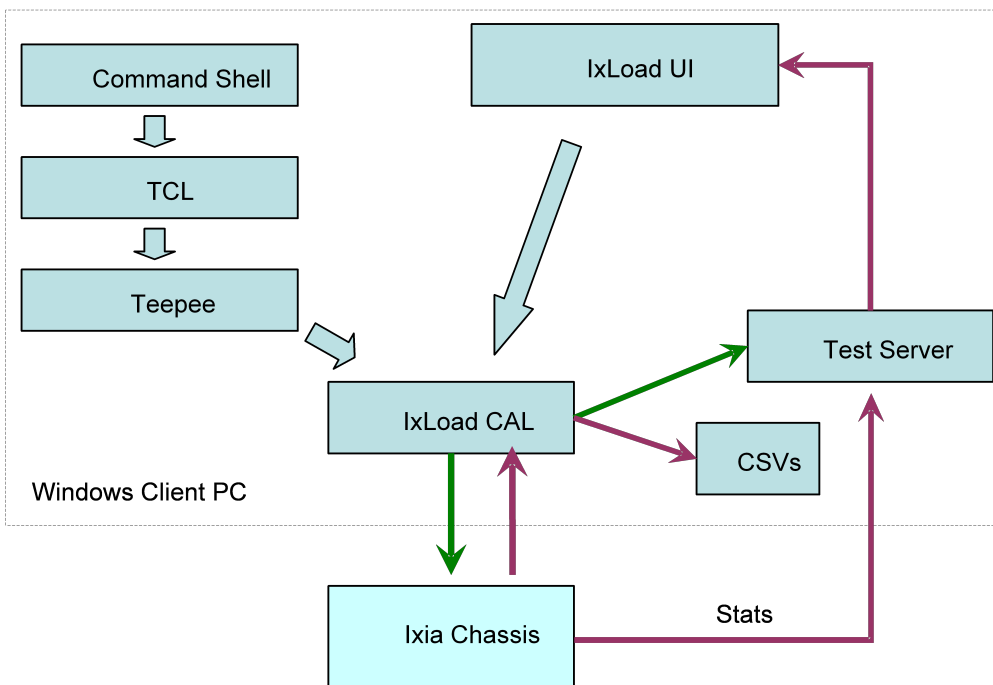

## Unix Overview

When running scripts on Unix:

- Unix script counts the same as a Windows script
- TCL Server is required on Client PC
- `::IxLoad connect/disconnect` command is required



- Log files go to PC
- C:\Program Files\Ixia\IxLoad\Client\tcl\remoteScriptingService directory
- Or, internal debug file `c:\rssN.log` (*N* is session # (0-4))
- Result files go to PC
- Path is on Windows system.
- If path is relative, then path is relative to the `remoteScriptingService` directory

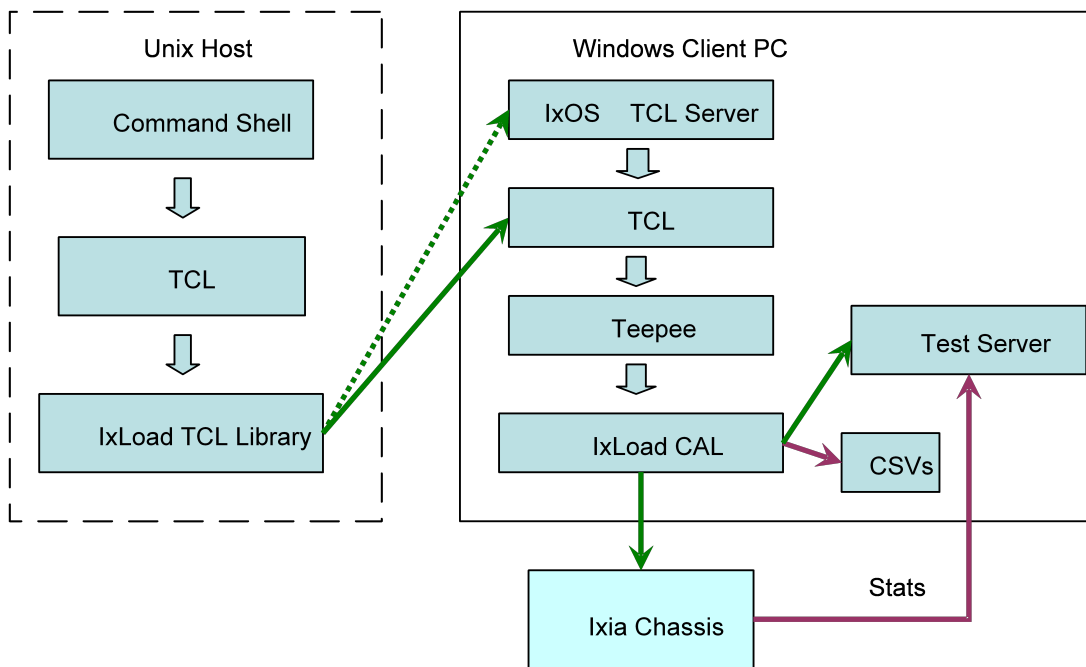

## Object Structure

The figure below shows the current TCL object structure.

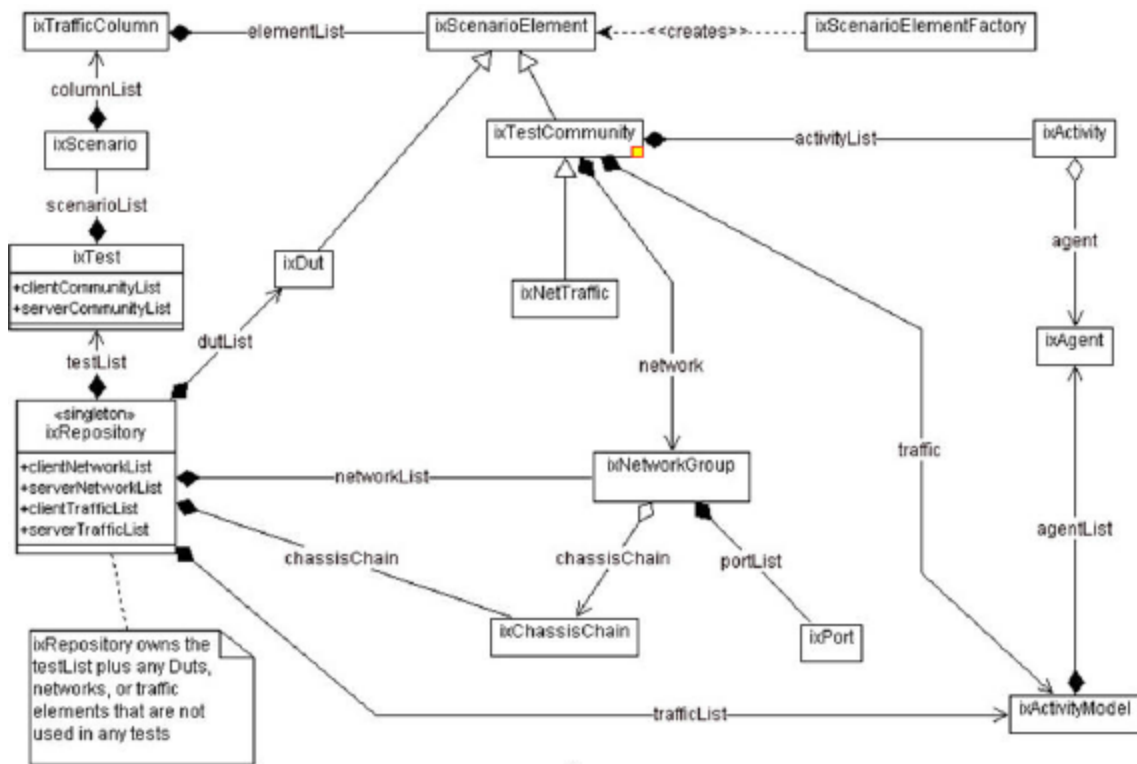

## Building an IxLoad Test

The following set of steps is a suggestion for the manner in which the Tcl API may be used to create a complete test. These steps mirror our suggested use of the IxLoad GUI. This is by no means the only manner in which a test may be developed. The code fragments used in this discussion are from a complete example, included at the end of this chapter.

### Step 1: Initial Overhead

This section performs the necessary overhead steps to get a test started. This includes:

- Add the IxWish or tclsh installer location. This script, when sourced, sets the `auto_path` so that package `req IxLoad` loads the version from which `IxiaW` was sourced. The `IxiaWish.tcl` is sourced from different path depending on a multiversion or non-multiversion release.
- Connect to the remote server. When running an IxLoad Tcl program on a non-Windows client it is necessary to use a Windows machine as a remote server. This may either be the Ixia chassis or some other Windows client. When run on a Windows machine, the `localhost` specification

should be used. A `catch { ... }` construct is used to ensure that a matching `disconnect` operation is invoked at the end of the script.

- A `package require` for the statistics utilities:
- to retrieve only the application protocol statistics, use the standard `IxLoad` package:

```
package require ixload
```

- to retrieve additional statistics such as network stack statistics and port CPU statistics, use the `ixloadcsv` package:

```
package require ixloadcsv
```

When the script runs, the `ixloadcsv` package will run the `IxLoad` GUI in a hidden mode in the background.

- Load the protocols needed for the test. A separate call to `$ixAppload` should be performed for each protocol required. See the table below for the protocols and corresponding string to be passed.
- Creation of a chassis chain to include a list of test related chassis.
- Creation of the top level `ixTest` object.

Protocol	String to Pass
HTTP	HTTP
FTP	FTP
POP3	POP3
RTSP	RTSP
IMAP	IMAP
LDAP	ldap
MGCP	MGCP
QuickHTTP	QuickHTTP
QuickTCP	QuickTCP
SIP	SIP
Telnet	Telnet
Video	Video
DDOS	DDoS
DHCP	dhcp

RADIUS	radius
SSH	ssh
Capture Replay	capturereplay
Application Test	verify
Vulnerability Attacks	nessus
TFTP	TFTP

- Creation of a chassis chain to include a list of test related chassis.
- Creation of the top level `ixTest` object.

```
#-----# Set path
to find Tcl API#-----
---set MY_IXLOAD_INSTALL "C:\\Program Files\\Ixia\\IxLoad"lappend ::auto_path [file
join $MY_IXLOAD_INSTALL "client" "tclex" "teepee" "stage"]

#-----# Uncomment
the following if you'll be using the Ixia Standard Tcl API#-----
-----#set MY_IXTCLHAL_INSTALL "C:\\Program
Files\\Ixia\\TclScripts"#lappend ::auto_path [file join $MY_IXTCLHAL_INSTALL "lib"
"ixTcl1.0"]

#-----# When run-
ning on Unix clients, it's necessary to connect to a remote# server. For Windows cli-
ents, this is unnecessary. In the line below,# change localhost to the IP address of
your remote server#-----
-----::IxLoad connect localhost

# This catch is used to ensure that we disconnect from the remote# server regardless
of how we exitcatch {

    #-----#
package require the stat collection utilities #-----#
-----package require statCollectorUtils
global ixAppPluginManager $ixAppPluginManager load "HTTP"

#-----#
Build Chassis Chain #-----#
-----set chassisName birdie set chassisChain [::IxLoad new
ixChassisChain] $chassisChain addChassis $chassisName

#-----#
```

---

```

Create the test #-----
----- set test [::IxLoad new ixTest \          -name          "my_test" \
-statsRequired 0 \          -enableResetPorts 0 ]

```

## Step 2: Define the TrafficFlow

In this step, we create the TrafficFlow that will list the test scenario.

This involves:

- Creation of an `ixTrafficFlow` instance.
- Appending the client, server and DUT object of `ixTrafficColumn`.

```

#-----
# Create TrafficFlow
#-----
set TrafficFlow1 [::IxLoad new ixTrafficFlow]
$TrafficFlow1 config \
-name          "TrafficFlow1"

#-----
# Append client object
#-----
$TrafficFlow1 columnList.appendItem -object $Client
set Client [::IxLoad new ixTrafficColumn]
    $Client config \
-name          "Client"

```

## Step 3: Define the TrafficColumn

This is a container of `ixNetTraffic` and `ixDut` objects.

This involves:

- Creation of an `ixTrafficColumn` instance
- Defining and configuring client, server and DUT.

```
#-----# Create the
client instance of ixTrafficColumn#-----
-----

set DUT [::IxLoad new ixTrafficColumn]$DUT config \-name
"DUT"
```

## Step 4: Define the NetTraffic

This step involves the configuration of client and server activities, configuring traffic, mapping traffic to network.

This involves:

- Creation of an `ixNetTraffic` instance
- Configuring traffic
- Configuring the client or server network
- Appending activityagent
- Defining and configuring the activity. For each protocol:
- Define and append an agent to its `agentList`.
- Perform protocol dependent settings; for example, add actions to the agent's operation by creating an instance of `ixHttpAction` and defining the options.
- Declare a timeline for each activity.

```
set HTTP_client_client_network [::IxLoad new ixNetTraffic]

#-----# Activity
newAgent1 of NetTraffic HTTP client@client network#-----
-----set Activity_newAgent1 [$HTTP_client_client_
network activityList.appendItem \-protocolAndType      "HTTP Cli-
ent" ]

#-----# Defining
Activity newAgent1#-----
-----$Activity_newAgent1 config \-enable      1 \-name
"newClientActivity1" \-enableConstraint      false \-
userObjectiveValue      100 \-constraintValue
100 \-userObjectiveType      "simulatedUsers" \-timeline
$Timeline1
```

```

#-----# Con-
figuring Activity newAgent1#-----
-----

$Activity_newAgent1 agent.config \-vlanPriority          0 \-
enableHttpsProxy          0 \-enableSsl
0 \-cookieRejectProbability 0.0 \-enableUnidirectionalClose
false \-ipPreference      2 \-loopValue
true \-maxPersistentRequests 1 \-enableEsm
0 \-certificate           "" \-sequentialSessionReuse
0 \-tos                   0 \-maxPipeline
1 \-maxHeaderLen         1024 \-maxSessions
3 \-enableHttpProxy      0 \-enableTos
false \-enable           1 \-browserEmulation
1 \-cookieJarSize        10 \-privateKey
"" \-privateKeyPassword  "" \-urlStatsCount
10 \-followHttpRedirects 0 \-tcpCloseOption
0 \-enableVlanPriority    false \-esm
1460 \-httpVersion        0 \-sslVersion
3 \-name                  "newClientActivity1" \-
enableCookieSupport      0 \-enableLargeHeader
false \-clientCiphers     "DEFAULT" \-httpProxy
":80" \-keepAlive         0 \-httpsProxy
":443"

$Activity_newAgent1 agent.actionList.clear

#-----
# Add actions to this client agent
#-----set my_
ixHttpAction [::IxLoad new ixHttpAction]$my_ixHttpAction config \
-profile -1 \
-namevalueargs "" \
-destination "HTTP server_newServerActivity1:80" \
-abort "None" \
-command      "GET" \
-arguments "" \
-pageObject  "/4k.html"

```

```
$Activity_newAgent1 agent.actionList.appendItem -object $my_ixHttpAction
```

## Step 5: Define ixSubscriberNetTraffic

The `ixSubscriberNetTraffic` is a special type of `NetTraffic` that simulates the traffic patterns created by residential customers that receive voice, video, and data service (Triple-play) over a single physical connection (usually a cable or DSL connection).

A Subscriber `NetTraffic` allows you to control the interactions between protocols for each user. This produces a traffic pattern that more accurately reproduces the pattern created by actual triple-play customers.

This involves:

- Creation of an `ixSubscriber NetTraffic` instance
- Configuring an `ixBandwidthLimit` object
- The rest is similar to `ixNetTraffic` described in Step 4: Define the `NetTraffic` (see "[Step 4: Define the NetTraffic](#)").

## Step 6: Define the NetworkGroup

This step involves the global network configuration.

This involves:

- Creation of an `ixNetworkGroup` client and server network instance
- Clearing the global plugins list

```
set Network1 [::IxLoad new ixNetworkGroup $chassisChain]
```

```
$Network1 config \
```

```
-comment      "" \
```

```
-name         "Network1" \
```

```
-macMappingMode 1 \
```

```
-linkLayerOptions 0
```

```
$Network1 globalPlugins.clear
```



## Step 7: Define the NetworkGroup

This step involves the network stack configuration.

This involves:

- Creating the network stack, including any extension protocols, appending the network stack plugins to the global plugin list, and then configuring them.
- Configuring the global settings (Dynamic Control plane)

```
set Filter [::IxLoad new ixNetFilterPlugin]
```

```
# ixNet objects needs to be added in the list before they are configured!
```

```
$Network1 globalPlugins.appendItem -object $Filter
```

```
$Filter config \
```

```
-all                false \  
-pppoecontrol      false \  
-isis              false \  
-name               "Filter" \  
-auto              true \  
-udp               "" \  
-tcp               "" \  
-mac               "" \  
-pppoenetwork      false \  
-ip                "" \  
-icmp              ""
```

```
set GratARP [::IxLoad new ixNetGratArpPlugin]
```

```
# ixNet objects needs to be added in the list before they are configured!
```

```
$Network1 globalPlugins.appendItem -object $GratARP
```

```
$GratARP config \
```

```
-enabled           true \  

```

```
-name                "GratARP"

set TCP [::IxLoad new ixNetTCPPlugin]
# ixNet objects needs to be added in the list before they are configured!
$Network1 globalPlugins.appendItem -object $TCP

$TCP config \
-name                "TCP" \
-tcp_orphan_retries 0 \
-tcp_max_tw_buckets 180000 \
-tcp_wmem_default   4096 \
-tcp_low_latency    0 \
-tcp_rmem_min       4096 \
-tcp_adv_win_scale  2 \
-tcp_wmem_min       4096 \
-tcp_port_min       1024 \
-tcp_stdurg         false \
-tcp_port_max       65535 \
-tcp_fin_timeout    60 \
-tcp_no_metrics_save false \
-tcp_dsack          true \
-tcp_mem_high       49152 \
-tcp_frto           0 \
-tcp_app_win        31 \
-ip_no_pmtu_disc    false \
-tcp_window_scaling false \
-tcp_max_orphans    8192 \
-tcp_mem_pressure   32768 \
-tcp_syn_retries    5
set DNS [::IxLoad new ixNetDnsPlugin]
```

---

```
# ixNet objects needs to be added in the list before they are configured!
```

```
$Network1 globalPlugins.appendItem -object $DNS
```

```
$DNS config \
```

```
-domain          "" \
```

```
-name            "DNS" \
```

```
-timeout         5
```

```
$DNS hostList.clear
```

```
$DNS searchList.clear
```

```
$DNS nameServerList.clear
```

```
set Settings [::IxLoad new ixNetIxLoadSettingsPlugin]
```

```
# ixNet objects needs to be added in the list before they are configured!
```

```
$Network1 globalPlugins.appendItem -object $Settings
```

```
$Settings config \
```

```
-teardownInterfaceWithUser      false \
```

```
-name                            "Settings" \
```

```
-interfaceBehavior              0
```

```
set Ethernet_1 [$Network1 getL1Plugin]
```

```
set my_ixNetEthernetELMPlugin [::IxLoad new ixNetEthernetELMPlugin]
```

```
$my_ixNetEthernetELMPlugin config \
```

```
-negotiationType                "master" \
```

```
-negotiateMasterSlave           true
```

```
$Ethernet_1 config \  
-advertise10Full          true \  
-name                     "Ethernet-1" \  
-autoNegotiate            true \  
-advertise100Half         true \  
-advertise10Half          true \  
-speed                    "k100FD" \  
-advertise1000Full        true \  
-advertise100Full         true \  
-cardElm                  $my_ixNetEthernetELMPlugin  
  
$Ethernet_1 childrenList.clear  
  
set MAC_VLAN_2 [::IxLoad new ixNetL2EthernetPlugin]  
# ixNet objects needs to be added in the list before they are configured!  
$Ethernet_1 childrenList.appendItem -object $MAC_VLAN_2  
  
$MAC_VLAN_2 config \  
-name                     "MAC/VLAN-2"  
  
$MAC_VLAN_2 childrenList.clear  
  
set IP_3 [::IxLoad new ixNetIpV4V6Plugin]  
# ixNet objects needs to be added in the list before they are configured!  
$MAC_VLAN_2 childrenList.appendItem -object $IP_3  
  
$IP_3 config \  
-name                     "IP-3"  
  
$IP_3 childrenList.clear
```

```
$IP_3 extensionList.clear
```

```
$MAC_VLAN_2 extensionList.clear
```

```
$Ethernet_1 extensionList.clear
```

```
#####
```

```
# Setting the ranges starting with the plugin on top of the stack
```

```
#####
```

```
$IP_3 rangeList.clear
```

```
set IP_R3 [::IxLoad new ixNetIPv4V6Range]
```

```
# ixNet objects needs to be added in the list before they are configured!
```

```
$IP_3 rangeList.appendItem -object $IP_R3
```

```
$IP_R3 config \
```

```
-count          1 \  
-name           "IP-R3" \  
-gatewayAddress "0.0.0.0" \  
-enabled        true \  
-autoMacGeneration true \  
-mss            1460 \  
-incrementBy    "0.0.0.1" \  
-prefix         16 \  
-gatewayIncrement "0.0.0.0" \  
-gatewayIncrementMode "perSubnet" \  
-generateStatistics false \  
-ipAddress      "10.10.0.4" \  
-ipType         "IPv4"
```

```
set MAC_R2 [$IP_R3 getLowerRelatedRange "MacRange"]
```

```
$MAC_R2 config \
```

```
-count          1 \  
-name           "MAC-R2" \  
-enabled        true \  
-mtu            1500 \  
-mac            "00:0A:0A:00:04:00" \  
-incrementBy    "00:00:00:00:00:01"
```

```
set VLAN_R1 [$IP_R3 getLowerRelatedRange "VlanIdRange"]
```

```
$VLAN_R1 config \
```

```
-incrementStep    1 \  
-uniqueCount      4094 \  
-name             "VLAN-R1" \  
-innerIncrement   1 \  
-innerUniqueCount 4094 \  
-enabled          true \  
-innerFirstId     1 \  
-increment        1 \  
-priority         1 \  
-firstId         1 \  
-innerIncrementStep 1 \  
-idIncrMode       2 \  
-innerEnable      false \  
-innerPriority     1
```

## Step 8: Define the NetworkRange

This step involves the creation of IP and MAC addresses.

This involves:

- Creation of an `ixNetworkRange` instance
- Configuring the network range used in a network

```
set Network_Range_1_in_client_network_198_18_0_1_100_ [::IxLoad new
ixNetworkRange]$Network_Range_1_in_client_network_198_18_0_1_100_ config \-
rangeType "Ethernet" \-vlanPriority
0 \-vlanEnable 0 \-innerVlanPriority
0 \-innerVlanUniqueCount 4094 \-innerVlanIncrStep
1 \-networkMask "255.255.0.0" \-vlanIncrStep
1 \-gateway "0.0.0.0" \-vlanIncrementMode
"inner-first" \-gatewayIncrStep "None" \-mssEnable
0 \-mss 1460 \-enableStats
false \-firstMac "00:C6:12:00:01:00" \-ipType
1 \-type 0 \-firstIp
"198.18.0.1" \-enable 1 \-vlanId
1 \-vlanCount 1 \-ipCount
100 \-vlanUniqueCount 4094 \-macIncrStep
"00:00:00:00:01:00" \-name "Network Range 1 in
client network (198.18.0.1+100)" \-innerVlanCount 1 \-
ipIncrStep "0.0.0.1" \-innerVlanId
1 \-innerVlanEnable false \-rxBandwidthLimit
$my_ixBandwidthLimit \-txBandwidthLimit $my_ixBandwidthLimit1
```

## Step 9: Define the ixTimeline

This object configures the time in the test when the activities in the `NetTraffics` come online, and how long they stay up for. It is also used to configure the test's objectives. This involves:

- Creating an instance of `ixTimeline` object
- Configuring the timeline and objectives

```
#####
# Timeline1 for activities HTTPClient1
#####
set Timeline1 [::IxLoad new ixTimeline]
$Timeline1 config \
-rampUpValue 10 \
```

```
-rampUpType          0 \  
-offlineTime        0 \  
-rampDownTime       20 \  
-standbyTime        0 \  
-iterations         1 \  
-rampUpInterval     1 \  
-sustainTime        20 \  
-timelineType       0 \  
-name               "Timeline1"
```

## Step 10: Prepare to Run the Test

In this step, we will perform all operations necessary before starting the actual test. This involves:

- Creating an instance of the `ixTestController`, defining where the results should be placed.
- Initializing the `statCollectorUtils`, by using its `Initialize` command.
- Clear all statistics with `ClearStats`.
- Add statistics that we are interested in via the `AddStat` command.
- Define a callback command to receive statistics update. A trivial routine is included in this example.

```
#-----  
# Create a test controller bound to the previously allocated  
# chassis chain. This will eventually run the test  
# we created earlier.  
#-----  
set testController [::IxLoad new ixTestController -outputDir 1]  
$testController setResultDir "[pwd]/RESULTS/simplehttpclientandserver"  
  
#####  
# Create the test controller to run the test  
#####  
set testController [::IxLoad new ixTestController -outputDir True]
```



```
$testController setResultDir "[pwd]/RESULTS/simpleHTTP_3"

set NS statCollectorUtils

set test_server_handle [$testController getTestServerHandle]
${NS}::Initialize -testServerHandle $test_server_handle

${NS}::ClearStats
$Test1 clearGridStats

set HTTP_Client_Per_URL_StatList { \
{"HTTP Client Per URL" "HTTP Aborted After Request" "kMax"} \
{"HTTP Client Per URL" "HTTP Aborted Before Request" "kMax"} \
{"HTTP Client Per URL" "HTTP Requests Failed" "kMax"} \
{"HTTP Client Per URL" "HTTP Requests Failed (400)" "kMax"} \
{"HTTP Client Per URL" "HTTP Requests Failed (401)" "kMax"} \
{"HTTP Client Per URL" "HTTP Requests Failed (403)" "kMax"} \
{"HTTP Client Per URL" "HTTP Requests Failed (404)" "kMax"} \
{"HTTP Client Per URL" "HTTP Requests Failed (407)" "kMax"} \
{"HTTP Client Per URL" "HTTP Requests Failed (408)" "kMax"} \
{"HTTP Client Per URL" "HTTP Requests Failed (4xx other)" "kMax"} \
{"HTTP Client Per URL" "HTTP Requests Failed (4xx)" "kMax"} \
{"HTTP Client Per URL" "HTTP Requests Failed (505)" "kMax"} \
{"HTTP Client Per URL" "HTTP Requests Failed (5xx other)" "kMax"} \
{"HTTP Client Per URL" "HTTP Requests Failed (5xx)" "kMax"} \
{"HTTP Client Per URL" "HTTP Requests Failed (Aborted)" "kMax"} \
{"HTTP Client Per URL" "HTTP Requests Failed (Bad Header)" "kMax"} \
{"HTTP Client Per URL" "HTTP Requests Failed (Read)" "kMax"} \
{"HTTP Client Per URL" "HTTP Requests Failed (Timeout)" "kMax"} \
```

```
{ "HTTP Client Per URL" "HTTP Requests Failed (Write)" "kMax" } \  
{ "HTTP Client Per URL" "HTTP Requests Sent" "kMax" } \  
{ "HTTP Client Per URL" "HTTP Requests Successful" "kMax" } \  
{ "HTTP Client Per URL" "HTTP Responses Received With Match" "kMax" } \  
{ "HTTP Client Per URL" "HTTP Responses Received Without Match" "kMax" } \  
}  
set HTTP_Client_StatList { \  
{ "HTTP Client" "Client Hello Sent" "kMax" } \  
{ "HTTP Client" "HTTP Aborted After Request" "kMax" } \  
{ "HTTP Client" "HTTP Aborted Before Request" "kMax" } \  
{ "HTTP Client" "HTTP Bytes" "kMax" } \  
{ "HTTP Client" "HTTP Bytes Received" "kMax" } \  
{ "HTTP Client" "HTTP Bytes Sent" "kMax" } \  
{ "HTTP Client" "HTTP Concurrent Connections" "kMax" } \  
{ "HTTP Client" "HTTP Connect Time (us)" "kAverageRate" } \  
{ "HTTP Client" "HTTP Connection Attempts" "kMax" } \  
{ "HTTP Client" "HTTP Connections" "kMax" } \  
{ "HTTP Client" "HTTP Content Bytes Received" "kMax" } \  
{ "HTTP Client" "HTTP Content Bytes Sent" "kMax" } \  
{ "HTTP Client" "HTTP Cookie headers Rejected - (Memory Overflow)" "kMax" } \  
{ "HTTP Client" "HTTP Cookies Received" "kMax" } \  
{ "HTTP Client" "HTTP Cookies Rejected" "kMax" } \  
{ "HTTP Client" "HTTP Cookies Rejected - (Cookiejar Overflow)" "kMax" } \  
{ "HTTP Client" "HTTP Cookies Rejected - (Domain Match Failed)" "kMax" } \  
{ "HTTP Client" "HTTP Cookies Rejected - (Path Match Failed)" "kMax" } \  
{ "HTTP Client" "HTTP Cookies Rejected - (Probabilistic Reject)" "kMax" } \  
{ "HTTP Client" "HTTP Cookies Sent" "kMax" } \  
{ "HTTP Client" "HTTP Requests Failed" "kMax" } \  
{ "HTTP Client" "HTTP Requests Failed (400)" "kMax" } \  
{ "HTTP Client" "HTTP Requests Failed (401)" "kMax" } \  
}
```

```
{ "HTTP Client" "HTTP Requests Failed (403)" "kMax" } \
{ "HTTP Client" "HTTP Requests Failed (404)" "kMax" } \
{ "HTTP Client" "HTTP Requests Failed (407)" "kMax" } \
{ "HTTP Client" "HTTP Requests Failed (408)" "kMax" } \
{ "HTTP Client" "HTTP Requests Failed (4xx other)" "kMax" } \
{ "HTTP Client" "HTTP Requests Failed (4xx)" "kMax" } \
{ "HTTP Client" "HTTP Requests Failed (505)" "kMax" } \
{ "HTTP Client" "HTTP Requests Failed (5xx other)" "kMax" } \
{ "HTTP Client" "HTTP Requests Failed (5xx)" "kMax" } \
{ "HTTP Client" "HTTP Requests Failed (Aborted)" "kMax" } \
{ "HTTP Client" "HTTP Requests Failed (Bad Header)" "kMax" } \
{ "HTTP Client" "HTTP Requests Failed (Read)" "kMax" } \
{ "HTTP Client" "HTTP Requests Failed (Timeout)" "kMax" } \
{ "HTTP Client" "HTTP Requests Failed (Write)" "kMax" } \
{ "HTTP Client" "HTTP Requests Sent" "kMax" } \
{ "HTTP Client" "HTTP Requests Successful" "kMax" } \
{ "HTTP Client" "HTTP Session Timeouts (408)" "kMax" } \
{ "HTTP Client" "HTTP Sessions Rejected (503)" "kMax" } \
{ "HTTP Client" "HTTP Simulated Users" "kSum" } \
{ "HTTP Client" "HTTP Time To First Byte (us)" "kAverageRate" } \
{ "HTTP Client" "HTTP Time To Last Byte (us)" "kAverageRate" } \
{ "HTTP Client" "HTTP Transactions" "kMax" } \
{ "HTTP Client" "HTTP Transactions Active" "kMax" } \
{ "HTTP Client" "HTTP Users Active" "kMax" } \
{ "HTTP Client" "SSL Alerts Received" "kMax" } \
{ "HTTP Client" "SSL Alerts Received (access_denied)" "kMax" } \
{ "HTTP Client" "SSL Alerts Received (bad_certificate)" "kMax" } \
{ "HTTP Client" "SSL Alerts Received (bad_record_mac)" "kMax" } \
{ "HTTP Client" "SSL Alerts Received (certificate_expired)" "kMax" } \
{ "HTTP Client" "SSL Alerts Received (certificate_revoked)" "kMax" } \
```

```
{"HTTP Client" "SSL Alerts Received (certificate_unknown)" "kMax"} \  
{"HTTP Client" "SSL Alerts Received (close_notify)" "kMax"} \  
{"HTTP Client" "SSL Alerts Received (decode_error)" "kMax"} \  
{"HTTP Client" "SSL Alerts Received (decompression_failure)" "kMax"} \  
{"HTTP Client" "SSL Alerts Received (decrypt_error)" "kMax"} \  
{"HTTP Client" "SSL Alerts Received (decryption_failed)" "kMax"} \  
{"HTTP Client" "SSL Alerts Received (export_restriction)" "kMax"} \  
{"HTTP Client" "SSL Alerts Received (handshake_failure)" "kMax"} \  
{"HTTP Client" "SSL Alerts Received (illegal_parameter)" "kMax"} \  
{"HTTP Client" "SSL Alerts Received (insufficient_security)" "kMax"} \  
{"HTTP Client" "SSL Alerts Received (internal_error)" "kMax"} \  
{"HTTP Client" "SSL Alerts Received (no_certificate)" "kMax"} \  
{"HTTP Client" "SSL Alerts Received (no_renegotiation)" "kMax"} \  
{"HTTP Client" "SSL Alerts Received (protocol_version)" "kMax"} \  
{"HTTP Client" "SSL Alerts Received (record_overflow)" "kMax"} \  
{"HTTP Client" "SSL Alerts Received (unexpected_message)" "kMax"} \  
{"HTTP Client" "SSL Alerts Received (unknown_ca)" "kMax"} \  
{"HTTP Client" "SSL Alerts Received (unsupported_certificate)" "kMax"} \  
{"HTTP Client" "SSL Alerts Received (user_canceled)" "kMax"} \  
{"HTTP Client" "SSL Alerts Sent" "kMax"} \  
{"HTTP Client" "SSL Alerts Sent (access_denied)" "kMax"} \  
{"HTTP Client" "SSL Alerts Sent (bad_certificate)" "kMax"} \  
{"HTTP Client" "SSL Alerts Sent (bad_record_mac)" "kMax"} \  
{"HTTP Client" "SSL Alerts Sent (certificate_expired)" "kMax"} \  
{"HTTP Client" "SSL Alerts Sent (certificate_revoked)" "kMax"} \  
{"HTTP Client" "SSL Alerts Sent (certificate_unknown)" "kMax"} \  
{"HTTP Client" "SSL Alerts Sent (close_notify)" "kMax"} \  
{"HTTP Client" "SSL Alerts Sent (decode_error)" "kMax"} \  
{"HTTP Client" "SSL Alerts Sent (decompression_failure)" "kMax"} \  
{"HTTP Client" "SSL Alerts Sent (decrypt_error)" "kMax"} \  

```

```
{"HTTP Client" "SSL Alerts Sent (decryption_failed)" "kMax"} \  
{"HTTP Client" "SSL Alerts Sent (export_restriction)" "kMax"} \  
{"HTTP Client" "SSL Alerts Sent (handshake_failure)" "kMax"} \  
{"HTTP Client" "SSL Alerts Sent (illegal_parameter)" "kMax"} \  
{"HTTP Client" "SSL Alerts Sent (insufficient_security)" "kMax"} \  
{"HTTP Client" "SSL Alerts Sent (internal_error)" "kMax"} \  
{"HTTP Client" "SSL Alerts Sent (no_certificate)" "kMax"} \  
{"HTTP Client" "SSL Alerts Sent (no_renegotiation)" "kMax"} \  
{"HTTP Client" "SSL Alerts Sent (protocol_version)" "kMax"} \  
{"HTTP Client" "SSL Alerts Sent (record_overflow)" "kMax"} \  
{"HTTP Client" "SSL Alerts Sent (unexpected_message)" "kMax"} \  
{"HTTP Client" "SSL Alerts Sent (unknown_ca)" "kMax"} \  
{"HTTP Client" "SSL Alerts Sent (unsupported_certificate)" "kMax"} \  
{"HTTP Client" "SSL Alerts Sent (user_canceled)" "kMax"} \  
{"HTTP Client" "SSL Bytes Received" "kMax"} \  
{"HTTP Client" "SSL Bytes Sent" "kMax"} \  
{"HTTP Client" "SSL Concurrent Sessions" "kMax"} \  
{"HTTP Client" "SSL Errors Received" "kMax"} \  
{"HTTP Client" "SSL Errors Received (bad certificate)" "kMax"} \  
{"HTTP Client" "SSL Errors Received (no certificate)" "kMax"} \  
{"HTTP Client" "SSL Errors Received (no cipher)" "kMax"} \  
{"HTTP Client" "SSL Errors Received (undefined error)" "kMax"} \  
{"HTTP Client" "SSL Errors Received (unsupported certificate)" "kMax"} \  
{"HTTP Client" "SSL Errors Sent" "kMax"} \  
{"HTTP Client" "SSL Errors Sent (bad certificate)" "kMax"} \  
{"HTTP Client" "SSL Errors Sent (no certificate)" "kMax"} \  
{"HTTP Client" "SSL Errors Sent (no cipher)" "kMax"} \  
{"HTTP Client" "SSL Errors Sent (undefined error)" "kMax"} \  
{"HTTP Client" "SSL Errors Sent (unsupported certificate)" "kMax"} \  
{"HTTP Client" "SSL Negotiation Finished Successfully" "kMax"} \  

```

```
{ "HTTP Client" "SSL Session Reuse Failed" "kMax" } \
{ "HTTP Client" "SSL Session Reuse Success" "kMax" } \
{ "HTTP Client" "SSL Throughput Bytes" "kMax" } \
{ "HTTP Client" "Server Hello Received" "kMax" } \
{ "HTTP Client" "TCP Accept Queue Entries" "kMax" } \
{ "HTTP Client" "TCP Connection Requests Failed" "kMax" } \
{ "HTTP Client" "TCP Connections Established" "kMax" } \
{ "HTTP Client" "TCP Connections in CLOSE STATE" "kMax" } \
{ "HTTP Client" "TCP Connections in CLOSE-WAIT State" "kMax" } \
{ "HTTP Client" "TCP Connections in CLOSING State" "kMax" } \
{ "HTTP Client" "TCP Connections in ESTABLISHED State" "kMax" } \
{ "HTTP Client" "TCP Connections in FIN-WAIT-1 State" "kMax" } \
{ "HTTP Client" "TCP Connections in FIN-WAIT-2 State" "kMax" } \
{ "HTTP Client" "TCP Connections in LAST-ACK State" "kMax" } \
{ "HTTP Client" "TCP Connections in LISTENING State" "kMax" } \
{ "HTTP Client" "TCP Connections in SYN-RECEIVED State" "kMax" } \
{ "HTTP Client" "TCP Connections in SYN-SENT State" "kMax" } \
{ "HTTP Client" "TCP Connections in TIME-WAIT State" "kMax" } \
{ "HTTP Client" "TCP FIN Received" "kMax" } \
{ "HTTP Client" "TCP FIN Sent" "kMax" } \
{ "HTTP Client" "TCP FIN-ACK Received" "kMax" } \
{ "HTTP Client" "TCP FIN-ACK Sent" "kMax" } \
{ "HTTP Client" "TCP Listen Queue Drops" "kMax" } \
{ "HTTP Client" "TCP Resets Received" "kMax" } \
{ "HTTP Client" "TCP Resets Sent" "kMax" } \
{ "HTTP Client" "TCP Retries" "kMax" } \
{ "HTTP Client" "TCP SYN Failed" "kMax" } \
{ "HTTP Client" "TCP SYN Sent" "kMax" } \
{ "HTTP Client" "TCP SYN-ACK Sent" "kMax" } \
{ "HTTP Client" "TCP SYN_SYN-ACK Received" "kMax" } \
```

```
{ "HTTP Client" "TCP Timeouts" "kMax" } \
}
```

```
set HTTP_Server_Per_URL_StatList { \
{ "HTTP Server Per URL" "HTTP Requests Failed" "kMax" } \
{ "HTTP Server Per URL" "HTTP Requests Failed (404)" "kMax" } \
{ "HTTP Server Per URL" "HTTP Requests Failed (50x)" "kMax" } \
{ "HTTP Server Per URL" "HTTP Requests Failed (Write Error)" "kMax" } \
{ "HTTP Server Per URL" "HTTP Requests Received" "kMax" } \
{ "HTTP Server Per URL" "HTTP Requests Successful" "kMax" } \
}
```

```
set HTTP_Server_StatList { \
{ "HTTP Server" "Client Hello Received" "kMax" } \
{ "HTTP Server" "HTTP Bytes Received" "kMax" } \
{ "HTTP Server" "HTTP Bytes Sent" "kMax" } \
{ "HTTP Server" "HTTP Content Bytes Received" "kMax" } \
{ "HTTP Server" "HTTP Content Bytes Sent" "kMax" } \
{ "HTTP Server" "HTTP Cookies Received" "kMax" } \
{ "HTTP Server" "HTTP Cookies Received With Matching ServerID" "kMax" } \
{ "HTTP Server" "HTTP Cookies Received With Non-matching ServerID" "kMax" } \
{ "HTTP Server" "HTTP Cookies Sent" "kMax" } \
{ "HTTP Server" "HTTP Requests Failed" "kMax" } \
{ "HTTP Server" "HTTP Requests Failed (404)" "kMax" } \
{ "HTTP Server" "HTTP Requests Failed (50x)" "kMax" } \
{ "HTTP Server" "HTTP Requests Failed (Write Error)" "kMax" } \
{ "HTTP Server" "HTTP Requests Received" "kMax" } \
{ "HTTP Server" "HTTP Requests Successful" "kMax" } \
{ "HTTP Server" "HTTP Session Timeouts (408)" "kMax" } \
{ "HTTP Server" "HTTP Sessions Rejected (503)" "kMax" } \
}
```

```
{ "HTTP Server" "HTTP Transactions Active" "kMax" } \
{ "HTTP Server" "SSL Alerts Received" "kMax" } \
{ "HTTP Server" "SSL Alerts Received (access_denied)" "kMax" } \
{ "HTTP Server" "SSL Alerts Received (bad_certificate)" "kMax" } \
{ "HTTP Server" "SSL Alerts Received (bad_record_mac)" "kMax" } \
{ "HTTP Server" "SSL Alerts Received (certificate_expired)" "kMax" } \
{ "HTTP Server" "SSL Alerts Received (certificate_revoked)" "kMax" } \
{ "HTTP Server" "SSL Alerts Received (certificate_unknown)" "kMax" } \
{ "HTTP Server" "SSL Alerts Received (close_notify)" "kMax" } \
{ "HTTP Server" "SSL Alerts Received (decode_error)" "kMax" } \
{ "HTTP Server" "SSL Alerts Received (decompression_failure)" "kMax" } \
{ "HTTP Server" "SSL Alerts Received (decrypt_error)" "kMax" } \
{ "HTTP Server" "SSL Alerts Received (decryption_failed)" "kMax" } \
{ "HTTP Server" "SSL Alerts Received (export_restriction)" "kMax" } \
{ "HTTP Server" "SSL Alerts Received (handshake_failure)" "kMax" } \
{ "HTTP Server" "SSL Alerts Received (illegal_parameter)" "kMax" } \
{ "HTTP Server" "SSL Alerts Received (insufficient_security)" "kMax" } \
{ "HTTP Server" "SSL Alerts Received (internal_error)" "kMax" } \
{ "HTTP Server" "SSL Alerts Received (no_certificate)" "kMax" } \
{ "HTTP Server" "SSL Alerts Received (no_renegotiation)" "kMax" } \
{ "HTTP Server" "SSL Alerts Received (protocol_version)" "kMax" } \
{ "HTTP Server" "SSL Alerts Received (record_overflow)" "kMax" } \
{ "HTTP Server" "SSL Alerts Received (unexpected_message)" "kMax" } \
{ "HTTP Server" "SSL Alerts Received (unknown_ca)" "kMax" } \
{ "HTTP Server" "SSL Alerts Received (unsupported_certificate)" "kMax" } \
{ "HTTP Server" "SSL Alerts Received (user_canceled)" "kMax" } \
{ "HTTP Server" "SSL Alerts Sent" "kMax" } \
{ "HTTP Server" "SSL Alerts Sent (access_denied)" "kMax" } \
{ "HTTP Server" "SSL Alerts Sent (bad_certificate)" "kMax" } \
{ "HTTP Server" "SSL Alerts Sent (bad_record_mac)" "kMax" } \
```



```
{"HTTP Server" "SSL Alerts Sent (certificate_expired)" "kMax"} \  
{"HTTP Server" "SSL Alerts Sent (certificate_revoked)" "kMax"} \  
{"HTTP Server" "SSL Alerts Sent (certificate_unknown)" "kMax"} \  
{"HTTP Server" "SSL Alerts Sent (close_notify)" "kMax"} \  
{"HTTP Server" "SSL Alerts Sent (decode_error)" "kMax"} \  
{"HTTP Server" "SSL Alerts Sent (decompression_failure)" "kMax"} \  
{"HTTP Server" "SSL Alerts Sent (decrypt_error)" "kMax"} \  
{"HTTP Server" "SSL Alerts Sent (decryption_failed)" "kMax"} \  
{"HTTP Server" "SSL Alerts Sent (export_restriction)" "kMax"} \  
{"HTTP Server" "SSL Alerts Sent (handshake_failure)" "kMax"} \  
{"HTTP Server" "SSL Alerts Sent (illegal_parameter)" "kMax"} \  
{"HTTP Server" "SSL Alerts Sent (insufficient_security)" "kMax"} \  
{"HTTP Server" "SSL Alerts Sent (internal_error)" "kMax"} \  
{"HTTP Server" "SSL Alerts Sent (no_certificate)" "kMax"} \  
{"HTTP Server" "SSL Alerts Sent (no_renegotiation)" "kMax"} \  
{"HTTP Server" "SSL Alerts Sent (protocol_version)" "kMax"} \  
{"HTTP Server" "SSL Alerts Sent (record_overflow)" "kMax"} \  
{"HTTP Server" "SSL Alerts Sent (unexpected_message)" "kMax"} \  
{"HTTP Server" "SSL Alerts Sent (unknown_ca)" "kMax"} \  
{"HTTP Server" "SSL Alerts Sent (unsupported_certificate)" "kMax"} \  
{"HTTP Server" "SSL Alerts Sent (user_canceled)" "kMax"} \  
{"HTTP Server" "SSL Bytes Received" "kMax"} \  
{"HTTP Server" "SSL Bytes Sent" "kMax"} \  
{"HTTP Server" "SSL Concurrent Sessions" "kMax"} \  
{"HTTP Server" "SSL Errors Received" "kMax"} \  
{"HTTP Server" "SSL Errors Received (bad certificate)" "kMax"} \  
{"HTTP Server" "SSL Errors Received (no certificate)" "kMax"} \  
{"HTTP Server" "SSL Errors Received (no cipher)" "kMax"} \  
{"HTTP Server" "SSL Errors Received (undefined error)" "kMax"} \  
{"HTTP Server" "SSL Errors Received (unsupported certificate)" "kMax"} \  

```

```
{"HTTP Server" "SSL Errors Sent" "kMax"} \  
{"HTTP Server" "SSL Errors Sent (bad certificate)" "kMax"} \  
{"HTTP Server" "SSL Errors Sent (no certificate)" "kMax"} \  
{"HTTP Server" "SSL Errors Sent (no cipher)" "kMax"} \  
{"HTTP Server" "SSL Errors Sent (undefined error)" "kMax"} \  
{"HTTP Server" "SSL Errors Sent (unsupported certificate)" "kMax"} \  
{"HTTP Server" "SSL Negotiation Finished Successfully" "kMax"} \  
{"HTTP Server" "SSL Session Reuse Failed" "kMax"} \  
{"HTTP Server" "SSL Session Reuse Success" "kMax"} \  
{"HTTP Server" "SSL Throughput Bytes" "kMax"} \  
{"HTTP Server" "Server Hello Sent" "kMax"} \  
{"HTTP Server" "TCP Accept Queue Entries" "kMax"} \  
{"HTTP Server" "TCP Connection Requests Failed" "kMax"} \  
{"HTTP Server" "TCP Connections Established" "kMax"} \  
{"HTTP Server" "TCP Connections in CLOSE STATE" "kMax"} \  
{"HTTP Server" "TCP Connections in CLOSE-WAIT State" "kMax"} \  
{"HTTP Server" "TCP Connections in CLOSING State" "kMax"} \  
{"HTTP Server" "TCP Connections in ESTABLISHED State" "kMax"} \  
{"HTTP Server" "TCP Connections in FIN-WAIT-1 State" "kMax"} \  
{"HTTP Server" "TCP Connections in FIN-WAIT-2 State" "kMax"} \  
{"HTTP Server" "TCP Connections in LAST-ACK State" "kMax"} \  
{"HTTP Server" "TCP Connections in LISTENING State" "kMax"} \  
{"HTTP Server" "TCP Connections in SYN-RECEIVED State" "kMax"} \  
{"HTTP Server" "TCP Connections in SYN-SENT State" "kMax"} \  
{"HTTP Server" "TCP Connections in TIME-WAIT State" "kMax"} \  
{"HTTP Server" "TCP FIN Received" "kMax"} \  
{"HTTP Server" "TCP FIN Sent" "kMax"} \  
{"HTTP Server" "TCP FIN-ACK Received" "kMax"} \  
{"HTTP Server" "TCP FIN-ACK Sent" "kMax"} \  
{"HTTP Server" "TCP Listen Queue Drops" "kMax"} \  

```

```

{"HTTP Server" "TCP Resets Received" "kMax"} \
{"HTTP Server" "TCP Resets Sent" "kMax"} \
{"HTTP Server" "TCP Retries" "kMax"} \
{"HTTP Server" "TCP SYN Failed" "kMax"} \
{"HTTP Server" "TCP SYN Sent" "kMax"} \
{"HTTP Server" "TCP SYN-ACK Sent" "kMax"} \
{"HTTP Server" "TCP SYN_SYN-ACK Received" "kMax"} \
{"HTTP Server" "TCP Timeouts" "kMax"} \
}

```

```

set statList [concat \
$HTTP_Client_Per_URL_StatList \
$HTTP_Client_StatList \
$HTTP_Server_Per_URL_StatList \
$HTTP_Server_StatList \
]

```

```

set count 1
foreach statItem $statList {
set caption      [format "Watch_Stat_%s" $count]
set statSourceType [lindex $statItem 0]
set statName     [lindex $statItem 1]
set aggregationType [lindex $statItem 2]

```

```

${NS}::AddStat \
-caption      $caption \
-statSourceType $statSourceType \
-statName     $statName \
-aggregationType $aggregationType \
-filterList   {}

```

```
incr count
}

proc ::my_stat_collector_command {args} {
  puts "====="
  puts "INCOMING STAT RECORD >>> $args"
  puts "Len = [llength $args]"
  puts [lindex $args 0]
  puts [lindex $args 1]
  puts "====="
}
${NS}::StartCollector -command ::my_stat_collector_command
```

## Step 11: Start the Test

In this step, we'll actually start and stop the test. The steps involved are:

- Start the statistics collector using `StartCollector`.
- Use the `ixTestController` instance to run the test.
- Wait for the test complete.
- Stop the statistics collector using `StopCollector`.
- Disconnect from the remote server. See [Initial Overhead](#) for more details.

```
${NS}::StartCollector -command ::my_stat_collector_command
```

```
#-----# Run the
test#-----# $testCon-
troller run $test
```

```
#-----# have the
script (v)wait until the test is over#-----
-----vwait ::ixTestControllerMonitor;puts $::ixTestCon-
trollerMonitor
```

```
#-----# Stop the
```

```

collector (running in the tcl event loop)#-----
-----${NS}::StopCollector

#-----# Cleanup#--
-----$testController
generateReport -detailedReport 1 -format "PDF;HTML"

$testController releaseConfigWaitFinish::IxLoad delete $chassisChain::IxLoad delete
$clnt_network::IxLoad delete $svr_network::IxLoad delete $clnt_traffic::IxLoad
delete $svr_traffic::IxLoad delete $clnt_t_n_mapping::IxLoad delete $svr_t_n_
mapping::IxLoad delete $test::IxLoad delete $testController::IxLoad delete
$logger::IxLoad delete $logEngine

#-----#
Disconnect#-----}]
{ puts $errorInfo}## Disconnect/Release application lock#::IxLoad disconnect

```

## Stopping a Test by Pressing Enter

You can configure a test to stop when the ENTER key is pressed. See below is the sample code.

For an example of a complete script that stops when ENTER is pressed, see the sample script `C:\Program Files\Ixia\IxLoad\Client\TclApi\Samples\simplehttp-aborrun.tcl`.

```

#-----# configure
stdin for polling#-----
----fconfigure stdin -blocking 0 -buffering none# wait for the first sample or test
stopwhile {$::ixTestControllerMonitor == "" && [read stdin] == ""} { after 100
set wakeup 1 # the script must call vwait or update while test runs # to keep
TCL event loop going. Otherwise, no stat collector # callbacks will be made, and
ixTestControllerMonitor will # never be set. vwait wakeup}#-----
-----# if aborted, then stop test
gracefully#-----if
{$::ixTestControllerMonitor == ""} { puts "" puts "!!!Aborting test at earli-
est opportunity!!!" puts "" # stop the run $testController stopRun #
# (v)wait until the test really stops # vwait ::ixTestControllerMonitor
puts $::ixTestControllerMonitor}## Stop the collector#${NS}::StopCollector#-----
-----# Cleanup#-----
-----

```

## Running an IxLoad Tcl Script

The following sections describe how to run an IxLoad Tcl script test.

Windows (see "[Windows](#)") describes how to run a script on Windows.

Unix / Linux (see "[Unix / Linux](#)") describes how to run a script on Unix/Linux.

### Windows

To run an IxLoad Tcl script, you can use either of the following Tcl shells:

- Wish shell: C:\Program Files\Ixia\Tcl\<version>\bin\wish.exe
- Tcl shell: C:\Program Files\Ixia\Tcl\<version>\bin\tclsh.exe

The IxLoad TCL code resides under C:\Program Files\Ixia\IxLoad\<version>\TclScripts. The code in the `setup_ixload_paths.tcl` script used in earlier releases is no longer used. Instead, the current method used by all Ixia applications is to source `TclScripts\bin\IxiaWish.tcl` for the application, and follow that with a `package require` command.



**Note:** If more than one version of IxLoad is installed, the `package require` command uses the highest-numbered version. To select a different version, include the complete version number in the command. For example:

```
package require ixload 4.20.0.88
```

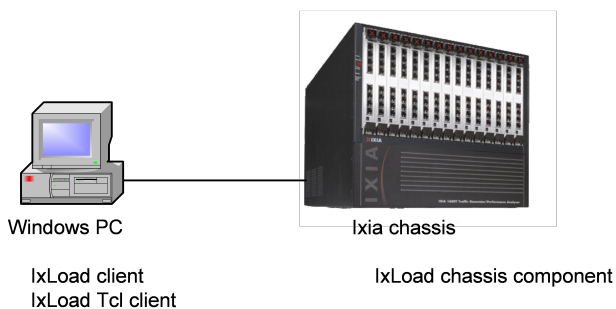

## Unix / Linux

To run an IxLoad Tcl script on Unix/Linux:

- You must use the `ixwish` shell or `IxTclsh` provided in the `bin` directory of the IxOS installation.
- You must install the IxOS Unix Tcl Client, and the IxLoad Unix Tcl client.

The `package require` command used in the sample scripts will only succeed if you have a version of IxLoad installed on the Unix/Linux machine that matches the one you request in the `package require` statement, and the environment is set up correctly

For multiversion support on Unix / Linux, the installer creates a `lib/IxLoad<version>` directory with a `pkgIndex.tcl` for each version of IxLoad that you install. The version number is the same one reported to TCL when the package is required. All normal `package require` logic applies to this.



**Note:** If more than one version of IxLoad is installed, the `package require` command uses the highest-numbered version. To select a different version, include the complete version number in the command. For example:

```
package require ixload 4.20.0.88
```

- You must install and run the IxLoad client on a Windows machine. When you run the TCL scripts on the Unix/Linux host, the TCL scripts are sent to the Windows machine and executed there. The results are also saved on the Windows host.

Ixia Tcl Server must be running on a Windows-based host, not the chassis. The Tcl Server machine is specified in a call to `connect` in the `::IxLoad` command. The `::IxLoad connect` call will only succeed if the specified client is:

- Running a compatible Tcl Server (release notes will detail the IxOS version that is compatible with a particular IxLoad version),
- Has the identical version of IxLoad installed that was actually loaded by the `package require` statement on the Unix machine (i.e. returned by the Unix `package require IxLoad` command).
- The `::IxLoad connect` command also performs the IxOS `ixConnectToTclServer`, so a separate call is not necessary to access the `ixTclHal` commands on the client machine.

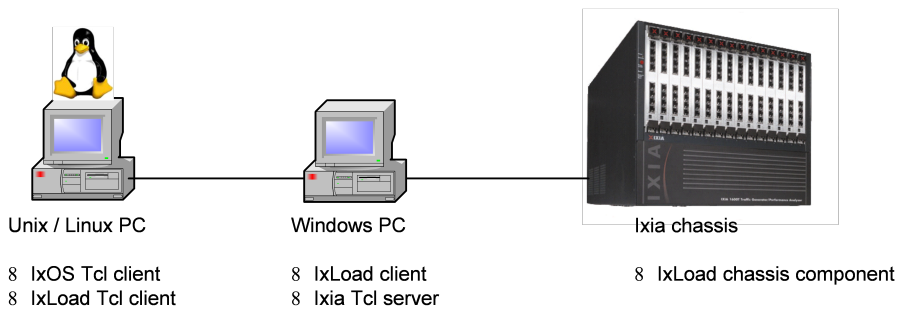

## Maximum Numbers of Scripts That Can Be Run

A maximum of four instances of IxLoad can run on a Windows client PC.

- Each copy of the IxLoad GUI counts as 2 instances.
- Each Tcl script counts as 1 instance.

If you receive the following error:

```
Error: exceptions.Exception: Already running maximum allowed copies of IxLoad.
```

the most likely cause is running more scripts than allowed (that is, from multiple shells or in the background).

Unix Tcl scripts are executed on the Windows client PC. If a Unix script is terminated (killed), the Windows client might take a few seconds to notice and kill the corresponding `tclsh`, but it still counts as a copy of IxLoad until the `tclsh` is killed.

Scripts running on the Windows client do not launch their own `tclsh`, but still count as an instance. If a Windows Tcl script running in `wish` crashes during execution, it still counts as a running copy until the `wish` shell is killed.

## Modifying Older Scripts

Multi-version support enables you to install multiple versions of IxLoad on the same client PC. Multi-version support was added to IxLoad beginning with release 3.40. If you want to run a non-multi-version (pre-3.40) script in a multi-version release, you must modify it.

To modify a multi-version script:

1. Open the script in an editor.
2. Remove following code from the old script:

```
if {$::tcl_platform(platform) == "windows"} {package require registry lset ::_
```



```
IXLOAD_INSTALL_ROOT [registry get {HKEY_LOCAL_MACHINE\Software\Ixia Com-
munications\IxLoad\InstallInfo} HOMEDIR]set ::_IXLOAD_PKG_DIR [file join $::_IXLOAD_
INSTALL_ROOT Client tclex tteepee stage]append ::auto_path $::_IXLOAD_PKG_DIR}
```

3. Replace the removed code with either of the following lines (replace <version> with the IxLoad version number):

```
source "C:\\Program Files\\Ixia\\IxLoad\\<version>\\TclScripts\\bin\\IxiaWish.tcl"
source "C:\\Program Files\\Ixia\\IxLoad\\<version>\\TclScripts\\bin\\IxiaWish.tcl"
```

4. Save and close the file.

## API Description

The following sections of this chapter are an overview of the Tcl API, by topic. They are described in the same order as the suggested steps in *Building an IxLoad Test*.

- **Network Commands**—Defines the client and server networks.
- **ixNetworkGroup**—Configure the global network.
- **ixChassisChain**—Indicates the chassis that are used in the test.
  - DUT Commands
- **ixDut**—Creates a DUT entry.
  - Traffic Commands
- **ixNetTraffic**—Configures client and server traffic.
- **activityList**—Generates traffic for one side of a particular protocol.
- **ixTimeline**—Configures the time in the test when the activities in the NetTraffics come online, and how long they stay up for. It is also used to configure the test's objectives.
  - Test Structure Commands
- **ixTimeline**—Configures the timeline and objectives for client and server.
- **ixTest**—Creates a complete test structure.
- **ixView**—Configures capture options in test repositories.
- **ixTrafficFlow**—Lists the test scenario.
- **ixTrafficColumn**—A container of ixNetTraffic and ixDut objects.
  - Test Operation Commands
- **ixTestController**—Starts and stops test.
- **ixTestControllerMonitor**—A global variable to watch for test completion.
- **statCollectorUtils**—Utilities for collecting statistics.

Reference pages for each of the IxLoad Tcl API commands are included in the following chapters:

- **IxLoad Tcl API Commands**. This includes a discussion of the most often used commands.
- **IxLoad Tcl API Internal Commands**. This includes a discussion of the behind-the-scenes commands on which most other commands are based.
- Each of the remaining chapters describes one of the supported protocols.

The remainder of this section is an overview of these commands, including brief descriptions of command operation, options, and subcommands.

## Network Commands

The commands in this section are the high-level used to create the networks used to support client and server traffic. There are minor differences between client and server net

The bulk of the network-related commands are described in the Network Stack API section.

### ixNetworkGroup

The `ixNetworkGroup` command is used to construct a client or server network, which is used as part of an `ixNetTraffic` object. A chassis chain object, as created in the `ixChassisChain` command, must be used in the construction of this object.

A list of network ranges, as defined in the `ixNetworkRange` object is associated with the client network. Network ranges are added to the client network through the use of the `networkRangeList.appendItem` command.

A list of Ixia ports is also associated with the network through the `portList` option.

If an emulated router is to be used, a list of IP ranges for the router is also associated with the network through the `emulatedRouterIpAddressPool` option. The pool is defined in the `ixEmulatedRouterIpAddressRange` object. These are added to the object through the use of the `em` command.

Refer to `ixNetworkGroup` for a full description of this command. The important subcommands and options of this command are listed below.

### ixClientNetwork Subcommands

Subcommand	Usage
<code>checkConfig</code>	Checks the configuration of this object, raising an exception in the case of an error.
<code>reset</code>	Disassociates the network from all of the Ixia ports used in this network.

### ixClientNetwork Options

Option	Usage
--------	-------

name	The name associated with this object.
networkRangeList	The networks that are defined for this object—a list of <code>ixNetworkRange</code> objects.
portList	The Ixia ports that will carry traffic for this network.
cardType	The card type for all of the ports in this network. Cards of a similar type must be used for all ports in a network. The <code>cardType</code> option is now used only for error/-diag messages, and is automatically selected. Please refer to <code>cardType</code> for the list of card types.
macMappingMode	Indicates whether one MAC address will be associated with each IP address or with each Ixia port. The use of the latter option indicates that an emulated router is to be used.
emulatedRouterIpAddressPool	If the <code>macMappingMode</code> indicates that one MAC is used per port, then this is a list of addresses ranges— a list of <code>ixEmulatedRouterIpAddressRange</code> objects.
emulatedRouterGateway	If the <code>macMappingMode</code> indicates that one MAC is used per port, then this is the gateway for the emulated router.
dnsParameters	An object of type <code>ixDns</code> , which defines DNS operation for this network.
arpSettings	An object of type <code>ixArpSettings</code> , which defines ARP operation for this network.
tcpParameters	An object of type <code>ixTcpParameters</code> , which defines TCP options for this network.
impairment	An object of type <code>ixImpairment</code> , which Impairs one or more types of traffic from a client and server network.

## ixChassisChain

Before defining client and server networks, it is necessary to define a chassis chain. This command is used to construct a chain of Ixia chassis, whose ports may be used in the `ixNetworkGroup` command. Chassis are assigned chassis IDs starting at 1; these are used in the network commands to define the chassis associated with the port.

Refer to `ixChassisChain` for a full description of this command. The important subcommands of this command are listed in the table below.

Subcommand	Usage
addChassis	Adds a chassis, by name or address, to the chassis chain.
setLoginName getLoginName	Sets and retrieves the user login name.
isValidChassisName	Checks to see whether a chassis name/address is valid.
getChassisNames	Returns the names of all of the chassis, ordered by their chassis IDs.
deleteChassisByName	Deletes a chassis, by name, from the list. The IDs of other chassis remain unaffected.
refresh refreshChassis	Rereads chassis information from one or all chassis.

## **ixEmulatedRouterIpAddressRange**

The `ixEmulatedRouterIpAddressRange` command is used to construct an list of IP addresses assigned on a per-port basis for emulated routers, as used in the `ixNetworkGroup` command.

Refer to `ixEmulatedRouterIpAddressRange` for a full description of this command. The important options of this command are listed below.

### **ixEmulatedRouterIpAddressRange Options**

Option	Usage
enable	Enables the use of this address range.
ipType	Type of address (IPv4 or IPv6).
firstIp lastIp	Controls the range of IP addresses generated.
networkMask	The network mask for the IP addresses.

## ixDns

The `ixDns` command is used to define DNS behavior on a network. A DNS object is set through the `dnsParameters` option of the `ixNetworkGroup` object.

Refer to `ixDns` for a full description of this command. The important options of this command are listed below:

### ixDns Options

Option	Usage
<code>enable</code>	Enables the use of this DNS specification.
<code>serverList</code>	A list of DNS servers to check at run time. This list consists of items of type <code>ixDnsServerItem</code> .
<code>suffixList</code>	A list of DNS suffixes to add to partial host names. This list consists of items of type <code>ixDnsSuffixList</code> .
<code>cacheTimeout</code>	The time-out value used for cached DNS lookups.

## ixDnsServerItem

The `ixDnsServerItem` command is used to define a DNS server on a network. A DNS server item object is appended to the `serverList` option of the `ixDns` object. For example,

```
set dns [::IxLoad new ixDns options...]
$test.dns.serverList appendItem \
-data192.168.3.1
```

Refer to `ixDnsServerItem` on page 4-36 for a full description of this command. The important options of this command are listed below.

### ixDnsServerItem Options

Option	Usage
<code>data</code>	The IP address of a DNS server.

## ixDnsSuffixList

The `ixDnsSuffixItem` command is used to define a DNS suffix. A DNS suffix item object is appended to the `suffixList` option of the `ixDns` object. For example,

```
set dns [::IxLoad new ixDns options...]  
$test.dns.suffixList appendItem \  
-data".ixiacom.com"
```

Refer to `ixDnsServerItem` for a full description of this command. The important options of this command are:

### ixDnsSuffixItem Options

Option	Usage
data	A domain name suffix.

## ixTcpParameters

The `ixTcpParameters` command is used to define TCP options on a network. A TCP parameters object is set in the `tcpParameters` option of an `ixNetworkGroup` object.

Refer to `ixTcpParameters` for a full description of this command. A wide range of low level TCP options are exposed in this command.

## ixEmulatedRouterIpAddressRange

The `ixEmulatedRouterIpAddressRange` command is used to construct an list of IP addresses assigned on a per-port basis for emulated routers, as used in the `ixNetworkGroup` command for both client and server.

Refer to `ixEmulatedRouterIpAddressRange` for a full description of this command.

## DUT Commands

In many cases, it is not necessary to define your DUT in an IxLoad test. Two cases are necessary, however:

- If your DUT is a Server Load Balancer (SLB) and the IP address of the DUT itself is the destination of client requests.
- If your DUT is a caching device, and direct server return is desired.

## ixDut

The `ixDut` command is used to define a DUT used in the test. The DUTs are used to resolve symbolic references to them in traffic destinations in the various protocol agents. It also controls several DUT specific features.

Refer to `ixDut` for a full description of this command. The important options of this command are listed below.

### ixDut Options

Option	Usage
<code>name</code>	The name associated with the DUT.
<code>type</code>	The type of the DUT—external server, SLB or firewall.
<code>ipAddress</code>	The IP address, virtual IP address, or host name to be used to access the DUT.
<code>serverNetwork</code>	If the DUT is an SLB, this is the network that will be balanced.
<code>enableDirectServer Return</code>	If the DUT is an SLB, this option allows balanced servers to send their return traffic directly back to the source of the request.

## Traffic Commands

The commands in this section relate to the generation of traffic by clients and the handling of traffic by servers.

### ixNetTraffic

The `ixNetTraffic` command is used to configure client or server traffic. Two separate `ixNetTraffic` objects have to be created for client and server traffic. The `ixNetTraffic` configuration also declares the `ixNetworkGroup` object. The `activityList` is appended to the `ixNetTraffic` object.

Refer to `ixNetTraffic` for a full description of this command.

## activityList

Generates traffic for one side of a particular protocol. For example, an HTTP client Activity generates HTTP client requests, simulating a web browser. The `activityList` is appended to the `ixNetTraffic` object.

Refer to `activityList` for a full description of this command.

## ixTimeline

Configures the time in the test when the activities in the `NetTraffics` come online, and how long they stay up for. It is also used to configure the test's objectives. The `ixTimeline` object is added to the `timeline` options of the `activityList` config.

Refer to `ixTimeline` for a full description of this command.

## Test Structure Commands

The commands in this section coordinate networks with traffic into communities, and communities into an entire test structure. These commands also define the operational parameters of the test.

## ixTest

The `ixTest` command is used to construct a complete IxLoad test structure. It consist of a list of client traffic-network and server traffic-network mappings, called communities. In addition to the two lists, several options control global operations. An `ixTest` command is used in conjunction with a `ixTestController` to operthe test and collect statistics.

A test is generally built via:

```
set test [::IxLoad new IxTest -name "my_test"]
$test clientCommunityList.appendItem -object $my_clients
$test serverCommunityList.appendItem -object $my_servers
```

Refer to `ixTest` for a full description of this command.

## ixView

Configures capture options in test repositories. It is added as an object instance to the `captureViewOptions` in `ixTest`.

Refer to `ixView` for a full description of this command.



## ixTrafficFlow

Lists the test scenario. The `ixTrafficFlow` command is used to list the test scenarios. Traffic Flow object is appended to the `ixTest` object.

Refer to `ixTrafficFlow` for a full description of this command.

## ixTrafficColumn

This is a container of `ixNetTraffic` and `ixDut` objects.

Refer to `ixTrafficColumn` for a full description of this command.

## Test Operation Commands

The commands in this section relate to the actual test and statistics gathering operations.

### ixTestController

The `ixTestController` command is used to setup, start, and stop an IxLoad test. It references the `ixTest` object in its `run` subcommand.

Refer to `ixTestController` for a full description of this command. The important subcommands and options of this command are listed below:

#### ixTestController Subcommands

Subcommand	Usage
<code>run</code>	Run the test. The name of an <code>ixTest</code> object is a required argument.
<code>setResultDir</code>	Specifies the location of where CSV files from the run are saved.
<code>isBusy</code>	Returns <code>true</code> while the test is running.
<code>getTestServerHandle</code>	Returns a value necessary for the statistics collection routines.

releaseConfigWaitFinish	<p>Releases all IxLoad configurations and waits for it to complete.</p> <hr/> <p><b>NOTE</b> Beginning with the IxLoad 8.00 release, <code>releaseConfigWaitFinish</code> will no longer be included in scripts created by ScriptGen.</p> <p>Instead, the following code will be included:</p> <pre>\$testController releaseConfig vwait ::ixTestControllerMonitor puts \$::ixTestControllerMonitor</pre> <p>This new method is asynchronous, meaning that after it is called, a script can execute other code between the call for <code>releaseConfig</code> and the <code>vwait</code> statement.</p> <p>Existing scripts that use <code>releaseConfigWaitFinish</code> will continue to function as before.</p> <hr/>
generateReport	Generates report from TCL.

## ixTestController Options

Options	Usage
outputDir	This should be set to a non-null value if you wish to save statistics in CSV files during the run. The actual directory used is set in the <code>setResultDir</code> subcommand.

## ixTestControllerMonitor

This is a global variable whose state may be used in a `vwait` to determine when a test has completed. Refer to `ixTestControllerMonitor` for a full description of this command.

## statCollectorUtils

The `statCollectorUtils` is a library containing several commands to gather statistics during a test run. Refer to `statCollectorUtils` on page for a full description of this library. The important commands of this library are:

### statCollectorUtils Commands

Subcommand	Usage
Initialize	Initializes the statistics utility package. Requires the result of a call to <code>ixTest getTestServerHandle</code> .
AddStat	Adds a statistic to the list of desired statistics to follow.
AddL2L3Stat	Adds a Layer 2 or 3 statistic to the list of desired statistics to follow.
AddNetworkStat	Adds a dynamic range network statistic to the list of desired statistics to follow.
AddPerInterfaceStat	Adds a per-range network statistic to the list of desired statistics to follow.
AddSIPPerStreamStat	Adds a SIP per-stream statistic to the list of desired statistics to follow.
AddVideoPerStreamStat	Adds a video per-stream statistic to the list of desired statistics to follow.
ClearStats	Clears the statistics values from any previous run.
StartCollector	Starts the statistics gathering process. The name of a user's callback command is passed in here.
StopCollector	Stops the statistics gathering process.

## Debugging

During the normal operation of the Tcl API, only errors and warnings are logged. To increase the level of debugging, you should use the following code fragment:

```
set logtag "IxLoad-api"
set logName "simplehttpclientandserver"
set logger [::CMD new ixLogger $logtag 1]
set logEngine [$logger getEngine]
$logEngine setLevels ::ixLogger(kLevelDebug) ::ixLogger(kLevelInfo)
$logEngine setFile $logName 2 256 1
```

The above fragment specifies that the log file name is prefixed with `simplehttpclientandserver`. The actual log file name is generated as fol

logName-<instance number>-<log file number>.log

where "instance number" is the number assigned to your session, with the first session being 1 up to a maximum of 4. "log file number" is a two digit number which is usually 00. Long or complicated tests may produce more log data than will fit in a single file, in which case a file ending with 01 will also exist. Extremely large logs may cause the sequence to start over, overwriting the original contents of log 00.

If the link is down on any of the ports in the test, the Tcl API logs the error in the log files but it does not display an error in the wish console. Although IxLoad allows the test to enter the "Configured" state with a link down, it will not allow the test to run.

## Logging Levels

In the code snippet, the following line defines an example of the settings of the setLevels API on the logger object.

```
$logEngine setLevels $::ixLogger(kLevelDebug) $::ixLogger(kLevelInfo)
```

The log levels are accessed using \$::ixLogger(kLevelxxx). The first value is the `file level` and the second value is the `console level`.

**File Level:** The file level should always be `kLevelDebug`. Otherwise, the log files will not contain enough information, in the event of a problem with the script.

**Console Level:** The second level is typically `kLevelInfo`, but can be set to the other levels as desired. Setting it to `kLevelDebug` is not recommended as it is likely to flood the console with internal messages.

The following are some of the other options for the `Console Level`:

::ixLogger value	Messages Logged
kLevelError	Error messages only.
kLevelWarning	Error and warning messages.
kLevelInfo	Error, warning, and informational messages.

## Log File Parameters

The following line defines the parameters of the log files:

```
$logEngine setFile $logName 2 256 1
```

2 is the number of log files to use before wrapping and overwriting the existing log files. The value 2 results in log files named \$logName-#-00.log and \$logName-#-01.log (the # is the session number and is determined dynamically by IxLoad. This also corresponds to the /S#/ in the login name for taking owner

256 is the size limit of each file, in KB.

1 is the truncate flag. 1 indicates to start the logging cycle over, using file -00, and deleting any previous log files. 0 causes logging to resume from where it left off.

## Log File Locations

For Windows scripts, the log file is stored in the current working directory of the Tcl shell. For Unix scripts, the file is stored on the intermediate Windows client hosting your remote script, in the directory C:\Program Files\Ixia\Ixload\Client\tcl\remoteScriptingService. To retrieve the log file from your Unix session, use the following script at the end of the test:

```
set fullLogName [file join "c:/Progra~1/IxLoad/Client/tcl\remoteScriptingService"
[$logEngine getFileName]]puts [::IxLoad retrieveFile $fullLogName]
```

## Sample Scripts Shipped with IxLoad

The table below lists the files in the C:\Program Files\Ixia\Ixload\<version>\TclScripts\Samples directory, which are shipped with IxLoad. The sample files are grouped under four folders under Samples: Application Features, Network, Protocols, and Stats.

File	Description
Application Features	
FTP_MixedTrafficMaps.tcl	Example of how to set up traffic on multiple (2) ports.
FTP_ModifyOnTheFly.tcl	Example on how to modify on the fly test objective value.
HTTP_AbortRun.tcl	Example of how to stop a test before completion.

HTTP_ActivityIpMapping.tcl	Example of how to configure IP addresses on a per-activity basis.
HTTP_Capture.tcl	Example of how capture test traffic.
HTTP_CaptureCustom.tcl	Similar to <code>HTTP_Capture.tcl</code> but with the default filter set to TCP.
HTTP_CaptureManual.tcl	Example of how capture test traffic by starting within the test script itself.
HTTP_ConfigStopRun.tcl	Example of how to stop and restart a test.
HTTP_CustomTrafficMap.tcl	Example of how to set up a custom traffic pattern on a symbolic destination (IxLoad server or client).
HTTP_RetrieveResultsAPI.tcl	Example of how to retrieve the test results.
RepNewHTTP.tcl	Example of how to create a new repository and configure with a basic HTTP protocol test.
RepRun.tcl	Example of how to load a repository and start a test.
setup_ixload_paths.tcl	Example of how to set up paths to IxLoad tcl code relative to install directory.
setup_simple.tcl	Setup script used for simple*.tcl tests. This file is sourced by all IxLoad sample tcl test scripts, and provides a convenient central place to change the chassis, port, and card that the tests will run on.
SIP_RenamedObjective.tcl	Example of how to rename a Test Objective for a SIP protocol test.
Network	
HTTP_DHCP.tcl	Example of how to configure a DHCP network range.
HTTP_EmulatedRouter.tcl	Example of how to configure an emulated router.
HTTP_IPDHCPRelay.tcl	Example of how to configure a IPDHCPRelay network range.
HTTP_IPSec.tcl	Example of how to configure a IPSec network range.
HTTP_IPv6.tcl	Example of how to configure a IPv6 network range.

HTTP_PPpOE.tcl	Example of how to configure a PPPoE network range.
HTTP_VLAN_Impairment.tcl	Example of how to configure impairment with VLANs.
setup_ixload_paths.tcl	Example of how to set up paths to IxLoad tcl code relative to install directory.
setup_simple.tcl	Setup script used for simple*.tcl tests. This file is sourced by all IxLoad sample tcl test scripts, and provides a convenient central place to change the chassis, port, and card that the tests will run on.
Protocols	
2.1.10_src_trace_http.-cap	Capture file for use with Trace File Replay test.
ApplicationTest.pft	Sample .pft file for use with Application Test protocol.
ApplicationTest.tcl	Sample .tcl file for use with Application Test protocol.
DDoS.tcl	Example of a basic LDAP protocol test.
DHCP.tcl	Example of a basic DHCP protocol test.
DNS.tcl	Example of a basic DNS protocol test.
FTP.tcl	Example of a basic FTP protocol test.
FTP_POP3.tcl	Example of a basic FTP-POP3 protocol test.
HTTP.tcl	Example of a basic HTTP protocol test.
HTTP_SSL.tcl	Example of a basic HTTP_SSL protocol test.
IMAP.tcl	Example of a basic IMAP protocol test.
LDAP.tcl	Example of a basic LDAP protocol test.
MGCP.tcl	Example of a basic MGCP protocol test.
MGCP_Signaling.tcl	Example of a basic MGCP_Signaling protocol test.
MGCP_Signaling_RTP.tcl	Example of a basic MGCP_Signaling_RTP protocol test.
POP3.tcl	Example of a basic POP3 protocol test.

QuickHTTP.tcl	Example of a basic QuickHTTP protocol test.
QuickTCP.tcl	Example of a basic QuickTCP protocol test.
RTSP.tcl	Example of a basic RTSP protocol test.
setup_ixoad_paths.tcl	Example of how to set up paths to IxLoad tcl code relative to install directory.
setup_simple.tcl	Setup script used for simple*.tcl tests. This file is sourced by all IxLoad sample tcl test scripts, and provides a convenient central place to change the chassis, port, and card that the tests will run on.
SIP.tcl	Example of a basic SIP protocol test.
sip_demo.wav	Audio file for SIP testing.
SIP_DTMF.tcl	Example of a SIP protocol test that uses DTMF tones.
SMTP.tcl	Example of a basic SMTP protocol test.
SPTS1-no_discontinuity	Video file for video testing.
TraceFileReplay.tcl	Example of a basic Trace File Replay (capture replay) test.
Video.tcl	Example of a basic Video protocol test.
Video_Configurable_Pid.tcl	Example of configuring Package Identifiers (PIDs) for Video protocol tests.
Video_Control_TS_Per_UDP.tcl	Example of configuring the number of transport stream (TS) packets contained in each UDP packet for Video protocol tests.
Video_I_Join_Latency.tcl	Example of how to measure the IGMP I Join latency in a Video protocol test.
Video_IGMPv1.tcl	Example of how to use IGMPv1 in a Video protocol test.
Video_MLDv1.tcl	Example of how to configure version 1 of Multicast Listener Discovery (MLD) in a Video protocol test.
Video_MLDv2.tcl	Example of how to configure version 2 of Multicast Listener Discovery (MLD) in a Video protocol test.
Video_Multicast_Profiles.tcl	Example of how to configure a multicast video test that uses profiles.



Video_Poisson.tcl	Example of how to configure the Poisson distribution in a Video protocol test.
VulnerabilityAttacks.tcl	Example of a basic Vulnerability (Nessus) test.
Stats	
HTTP_Per-InterfaceStats.tcl	Example of how to configure per-interface statistics for a HTTP protocol test.
HTTP_Per-UrlPerIpStats.tcl	Example of how to configure per-url and per-IP statistics for a HTTP protocol test.
HTTP_RepRun_Stats.tcl	Example of how to load a repository, run an HTTP test, and retrieve the statistics.
HTTP_StateStats.tcl	Example of how to retrieve the Run State and Iteration Count statistics.
HTTP_StatFilter.tcl	Example of how to filter statistics by activity.
setup_ixload_paths.tcl	Example of how to set up paths to IxLoad tcl code relative to install directory.
setup_simple.tcl	Setup script used for simple*.tcl tests. This file is sourced by all IxLoad sample tcl test scripts, and provides a convenient central place to change the chassis, port, and card that the tests will run on.
SIP_PerStreamStats.tcl	Example of how to configure per-stream statistics for a SIP protocol test.
Video_Per-StreamStats.tcl	Example of how to configure per-stream statistics for a Video protocol test.

Examples in the `Samples/...` directory should be run from that directory.

## Example Program

The following is the complete example used in the `Building an IxLoad Test` section of this chapter. This example is similar to, but not identical to the `C:\Program Files\Ixia\IxLoad\Client\TclApi\Samples\simplehttpclientandserver.tcl` file. This file is self-contained and omits some advanced usage features.

```
#####
```

```
# IxLoad ScriptGen created TCL script
# Test1 serialized using version 4.10.0.79
# simpleHTTP.tcl made on Aug 29 2008 15:03
#####

#####
# Copy content of setup_ixload_paths.tcl
#####

package require IxLoad

::IxLoad connect 1.2.3.4

if [catch {

set logtag "IxLoad-api"
set logName "simpleHTTP"
set logger [::IxLoad new ixLogger $logtag 1]
set logEngine [$logger getEngine]
$logEngine setLevels $::ixLogger(kLevelDebug) $::ixLogger(kLevelInfo)
$logEngine setFile $logName 2 256 1

global ixAppPluginManager
$ixAppPluginManager load "HTTP"

#####
# Build chassis chain
#####
set chassisChain [::IxLoad new ixChassisChain]

set my_ixViewOptions [::IxLoad new ixViewOptions]
$my_ixViewOptions config \
-runMode 1 \
-captureRunDuration 0 \
-captureRunAfter 0 \
-collectScheme 0 \
-allocatedBufferMemoryPercentage 30

set Test1 [::IxLoad new ixTest]
$Test1 config \
-comment "" \
-csvInterval 4 \
-networkFailureThreshold 0 \
-name "Test1" \
-statsRequired 1 \
-enableResetPorts 0 \
-enableNetworkStats false \
-enableForceOwnership false \
-enableReleaseConfigAfterRun 0 \
-currentUniqueIDForAgent 2 \
-allowMultiple1GAggregatedPorts false \
-captureViewOptions $my_ixViewOptions
```

```

$Test1 scenarioList.clear

set TrafficFlow1 [::IxLoad new ixTrafficFlow]
$TrafficFlow1 config \
-name "TrafficFlow1"

$TrafficFlow1 columnList.clear

set Client [::IxLoad new ixTrafficColumn]
$Client config \
-name "Client"

$Client elementList.clear

set HTTP_client_client_network [::IxLoad new ixNetTraffic]

#####
# Activity newClientActivity1 of NetTraffic HTTP client@client network
#####
set Activity_newClientActivity1 [$HTTP_client_client_network activ-
ityList.appendItem \
-protocolAndType "HTTP Client" ]

#####
# Timeline1 for activities newClientActivity1
#####
set Timeline1 [::IxLoad new ixTimeline]
$Timeline1 config \
-rampUpValue 5 \
-rampUpType 0 \
-offlineTime 0 \
-rampDownTime 20 \
-standbyTime 0 \
-iterations 1 \
-rampUpInterval 1 \
-sustainTime 60 \
-timelineType 0 \
-name "Timeline1"

$Activity_newClientActivity1 config \
-enable 1 \
-name "newClientActivity1" \
-userIpMapping "1:1" \
-enableConstraint false \
-userObjectiveValue 100 \
-constraintValue 100 \
-userObjectiveType "simulatedUsers" \
-timeline $Timeline1

$Activity_newClientActivity1 agent.config \
-vlanPriority 0 \
-enableDecompressSupport false \
-enableHttpsProxy 0 \

```

```
-enableSsl 0 \  
-enableUnidirectionalClose 0 \  
-uniqueID 1 \  
-ipPreference 2 \  
-loopValue 1 \  
-maxPersistentRequests 1 \  
-enableEsm 0 \  
-certificate "" \  
-sequentialSessionReuse 0 \  
-tos 0 \  
-maxPipeline 1 \  
-maxHeaderLen 1024 \  
-maxSessions 3 \  
-enableHttpProxy 0 \  
-enableTos false \  
-cookieRejectProbability 0.0 \  
-browserEmulation 1 \  
-cookieJarSize 10 \  
-privateKey "" \  
-commandTimeout 600 \  
-enableIntegrityCheckSupport false \  
-commandTimeout_ms 0 \  
-privateKeyPassword "" \  
-urlStatsCount 10 \  
-followHttpRedirects 0 \  
-tcpCloseOption 0 \  
-enableVlanPriority 0 \  
-esm 1460 \  
-httpVersion 0 \  
-sslVersion 3 \  
-enableCookieSupport 0 \  
-enableLargeHeader 0 \  
-clientCiphers "DEFAULT" \  
-httpProxy ":80" \  
-keepAlive 0 \  
-enableCRCCheckSupport false \  
-httpsProxy ":443"  
  
$Activity_newClientActivity1 agent.actionList.clear  
  
set my_ixHttpAction [::IxLoad new ixHttpAction]  
$my_ixHttpAction config \  
-profile -1 \  
-namevalueargs "" \  
-destination "HTTP server_newServerActivity1:80" \  
-abort "None" \  
-command "GET" \  
-arguments "" \  
-pageObject "/4k.html"  
  
$Activity_newClientActivity1 agent.actionList.appendItem -object $my_ixHttpAction  
  
$Activity_newClientActivity1 agent.headerList.clear
```

```

set my_ixHttpRequestString [::IxLoad new ixHttpRequestString]
$my_ixHttpRequestString config \
-data                          "Accept: */*"

$Activity_newClientActivity1 agent.headerList.appendItem -object $my_ixHttpRequestString

set my_ixHttpRequestString1 [::IxLoad new ixHttpRequestString]
$my_ixHttpRequestString1 config \
-data                          "Accept-Language: en-us"

$Activity_newClientActivity1 agent.headerList.appendItem -object $my_ixHttpRequestString1

set my_ixHttpRequestString2 [::IxLoad new ixHttpRequestString]
$my_ixHttpRequestString2 config \
-data                          "Accept-Encoding: gzip, deflate"

$Activity_newClientActivity1 agent.headerList.appendItem -object $my_ixHttpRequestString2

set my_ixHttpRequestString3 [::IxLoad new ixHttpRequestString]
$my_ixHttpRequestString3 config \
-data                          "User-Agent: Mozilla/4.0 (compatible;
MSIE 5.01; Windows NT 5.0)"

$Activity_newClientActivity1 agent.headerList.appendItem -object $my_ixHttpRequestString3

$Activity_newClientActivity1 agent.profileList.clear

#####
# Network client network of NetTraffic HTTP client@client network
#####
set client_network [::IxLoad new ixNetworkGroup $chassisChain]
$client_network config \
-comment                      "" \
-name                          "client network" \
-macMappingMode                0 \
-linkLayerOptions              0

$client_network globalPlugins.clear

set Filter [::IxLoad new ixNetFilterPlugin]
# ixNet objects needs to be added in the list before they are configured!
$client_network globalPlugins.appendItem -object $Filter

$Filter config \
-all                          false \
-pppoecontrol                  false \
-isis                          false \

```

```
-name                "Filter" \  
-auto                true \  
-udp                 "" \  
-tcp                 "" \  
-mac                 "" \  
-pppoenetwork       false \  
-ip                  "" \  
-icmp                ""  
  
set GratARP [::IxLoad new ixNetGratArpPlugin]  
# ixNet objects needs to be added in the list before they are configured!  
$client_network globalPlugins.appendItem -object $GratARP  
  
$GratARP config \  
-enabled            true \  
-name                "GratARP"  
  
set TCP [::IxLoad new ixNetTCPPlugin]  
# ixNet objects needs to be added in the list before they are configured!  
$client_network globalPlugins.appendItem -object $TCP  
  
$TCP config \  
-tcp_bic             0 \  
-tcp_tw_recycle      true \  
-tcp_retries2        15 \  
-tcp_retries1        3 \  
-tcp_keepalive_time  9 \  
-tcp_moderate_rcvbuf 0 \  
-tcp_rfc1337         false \  
-tcp_ipfrag_time     30 \  
-tcp_rto_max         60000 \  
-tcp_vegas_alpha     2 \  
-tcp_ecn             false \  
-tcp_westwood        0 \  
-tcp_rto_min         1000 \  
-tcp_reordering      3 \  
-tcp_vegas_cong_avoid 0 \  
-tcp_keepalive_intvl 7200 \  
-tcp_rmem_max        262144 \  
-tcp_orphan_retries  0 \  
-tcp_max_tw_buckets  180000 \  
-tcp_wmem_default    4096 \  
-tcp_low_latency     0 \  
-tcp_rmem_min        4096 \  
-tcp_adv_win_scale   2 \  
-tcp_wmem_min        4096 \  
-tcp_port_min        1024 \  
-tcp_stdurg          false \  
-tcp_port_max        65535 \  
-tcp_fin_timeout     60 \  
-tcp_no_metrics_save false \  
-tcp_dsack           true \  
-tcp_mem_high        49152 \  

```

```

-tcp_frto 0 \
-tcp_app_win 31 \
-ip_no_pmtu_disc false \
-tcp_window_scaling false \
-tcp_max_orphans 8192 \
-tcp_mem_pressure 32768 \
-tcp_syn_retries 5 \
-name "TCP" \
-tcp_max_syn_backlog 1024 \
-tcp_mem_low 24576 \
-tcp_fack true \
-tcp_retrans_collapse true \
-tcp_rmem_default 4096 \
-tcp_keepalive_probes 75 \
-tcp_abort_on_overflow false \
-tcp_tw_reuse false \
-tcp_wmem_max 262144 \
-tcp_vegas_gamma 2 \
-tcp_synack_retries 5 \
-tcp_timestamps true \
-tcp_vegas_beta 6 \
-tcp_sack true \
-tcp_bic_fast_convergence 1 \
-tcp_bic_low_window 14

set DNS [::IxLoad new ixNetDnsPlugin]
# ixNet objects needs to be added in the list before they are configured!
$client_network globalPlugins.appendItem -object $DNS

$DNS config \
-domain "" \
-name "DNS" \
-timeout 30000

$DNS hostList.clear

$DNS searchList.clear

$DNS nameServerList.clear

set Settings [::IxLoad new ixNetIxLoadSettingsPlugin]
# ixNet objects needs to be added in the list before they are configured!
$client_network globalPlugins.appendItem -object $Settings

$Settings config \
-teardownInterfaceWithUser false \
-name "Settings" \
-interfaceBehavior 0

set Ethernet_1 [$client_network getL1Plugin]

set my_ixNetEthernetELMPlugin [::IxLoad new ixNetEthernetELMPlugin]
$my_ixNetEthernetELMPlugin config \

```

```
-negotiationType                "master" \  
-negotiateMasterSlave          true  
  
$Ethernet_1 config \  
-advertise10Full               true \  
-name                           "Ethernet-1" \  
-autoNegotiate                 true \  
-advertise100Half              true \  
-advertise10Half               true \  
-speed                          "k100FD" \  
-advertise1000Full             true \  
-advertise100Full              true \  
-cardElm                       $my_ixNetEthernetELMPlugin  
  
$Ethernet_1 childrenList.clear  
  
set MAC_VLAN_1 [::IxLoad new ixNetL2EthernetPlugin]  
# ixNet objects needs to be added in the list before they are configured!  
$Ethernet_1 childrenList.appendItem -object $MAC_VLAN_1  
  
$MAC_VLAN_1 config \  
-name                           "MAC/VLAN-1"  
  
$MAC_VLAN_1 childrenList.clear  
  
set IP_1 [::IxLoad new ixNetIPv4V6Plugin]  
# ixNet objects needs to be added in the list before they are configured!  
$MAC_VLAN_1 childrenList.appendItem -object $IP_1  
  
$IP_1 config \  
-name                           "IP-1"  
  
$IP_1 childrenList.clear  
  
$IP_1 extensionList.clear  
  
$MAC_VLAN_1 extensionList.clear  
  
$Ethernet_1 extensionList.clear  
  
#####  
# Setting the ranges starting with the plugin on top of the stack  
#####  
$IP_1 rangeList.clear  
  
set IP_R1 [::IxLoad new ixNetIPv4V6Range]  
# ixNet objects needs to be added in the list before they are configured!  
$IP_1 rangeList.appendItem -object $IP_R1  
  
$IP_R1 config \  
-count                          100 \  
-name                           "IP-R1" \  
-gatewayAddress                 "0.0.0.0" \  

```



```

-enabled                true \
-autoMacGeneration     true \
-mss                   1460 \
-incrementBy           "0.0.0.1" \
-prefix                16 \
-gatewayIncrement      "0.0.0.0" \
-gatewayIncrementMode  "perSubnet" \
-generateStatistics    false \
-ipAddress              "198.18.0.1" \
-ipType                "IPv4"

set MAC_R1 [$IP_R1 getLowerRelatedRange "MacRange"]

$MAC_R1 config \
-count                100 \
-name                 "MAC-R1" \
-enabled              true \
-mtu                  1500 \
-mac                  "00:C6:12:00:01:00" \
-incrementBy         "00:00:00:00:00:01"

set VLAN_R1 [$IP_R1 getLowerRelatedRange "VlanIdRange"]

$VLAN_R1 config \
-incrementStep        100 \
-uniqueCount          4094 \
-name                 "VLAN-R1" \
-innerIncrement       1 \
-innerUniqueCount     4094 \
-enabled              false \
-innerFirstId         1 \
-increment            1 \
-priority             0 \
-firstId              1 \
-innerIncrementStep   1 \
-idIncrMode           1 \
-innerEnable          false \
-innerPriority         0

$HTTP_client_client_network config \
-enable               1 \
-network              $client_network

$HTTP_client_client_network traffic.config \
-name                 "HTTP client"

$Client elementList.appendItem -object $HTTP_client_client_network

$TrafficFlow1 columnList.appendItem -object $Client

set DUT [::IxLoad new ixTrafficColumn]
$DUT config \
-name                 "DUT"

```

```
$DUT elementList.clear

$TrafficFlow1 columnList.appendItem -object $DUT

set Server [::IxLoad new ixTrafficColumn]
$Server config \
-name "Server"

$Server elementList.clear

set HTTP_server_server_network [::IxLoad new ixNetTraffic]

#####
# Activity newServerActivity1 of NetTraffic HTTP server@server network
#####
set Activity_newServerActivity1 [$HTTP_server_server_network activ-
ityList.appendItem \
-protocolAndType "HTTP Server" ]

set _Match_Longest_ [::IxLoad new ixMatchLongestTimeline]

$Activity_newServerActivity1 config \
-enable 1 \
-name "newServerActivity1" \
-timeline $_Match_Longest_

$Activity_newServerActivity1 agent.config \
-vlanPriority 0 \
-maxResponseDelay 0 \
-uniqueID 2 \
-enableEsm 0 \
-certificate "" \
-tos 0 \
-enableMD5Checksum false \
-httpPort "80" \
-httpsPort "443" \
-esm 1460 \
-enableTos false \
-integrityCheckOption "Custom MD5" \
-privateKey "" \
-privateKeyPassword "" \
-urlStatsCount 10 \
-tcpCloseOption 0 \
-enableVlanPriority 0 \
-docrootfile "" \
-dhParams "" \
-requestTimeout 300 \
-ServerCiphers "DEFAULT" \
-acceptSslConnections 0 \
-enablePerServerPerURLstat 0 \
-enableDHsupport 0 \
-minResponseDelay 0
```

```
$Activity_newServerActivity1 agent.webPageList.clear

set 200_OK [::IxLoad new ResponseHeader]
$200_OK config \
-mimeType           "text/plain" \
-expirationMode     0 \
-code               "200" \
-name               "200_OK" \
-lastModifiedMode   1 \
-lastModifiedIncrementEnable false \
-lastModifiedDateTimeValue "2005/02/02 21:55:04" \
-lastModifiedIncrementFor 1 \
-expirationDateTimeValue "2005/03/04 21:55:04" \
-expirationAfterRequestValue 3600 \
-expirationAfterLastModifiedValue 3600 \
-lastModifiedIncrementBy 5 \
-description        "OK"

$200_OK responseList.clear

set my_PageObject [::IxLoad new PageObject]
$my_PageObject config \
-Md5Option          0 \
-payloadSize        "1-1" \
-customPayloadId    -1 \
-payloadType        "range" \
-payloadFile        "<specify file>" \
-page               "/1b.html" \
-response           $200_OK

$Activity_newServerActivity1 agent.webPageList.appendItem -object $my_PageObject

set my_PageObject1 [::IxLoad new PageObject]
$my_PageObject1 config \
-Md5Option          0 \
-payloadSize        "4096-4096" \
-customPayloadId    -1 \
-payloadType        "range" \
-payloadFile        "<specify file>" \
-page               "/4k.html" \
-response           $200_OK

$Activity_newServerActivity1 agent.webPageList.appendItem -object $my_PageObject1

set my_PageObject2 [::IxLoad new PageObject]
$my_PageObject2 config \
-Md5Option          0 \
-payloadSize        "8192-8192" \
-customPayloadId    -1 \
-payloadType        "range" \
-payloadFile        "<specify file>" \
-page               "/8k.html" \
```

```
-response                                $200_OK

$Activity_newServerActivity1 agent.webPageList.appendItem -object $my_PageObject2

set my_PageObject3 [::IxLoad new PageObject]
$my_PageObject3 config \
-Md5Option                                0 \
-payloadSize                             "16536-16536" \
-customPayloadId                          -1 \
-payloadType                              "range" \
-payloadFile                              "<specify file>" \
-page                                     "/16k.html" \
-response                                $200_OK

$Activity_newServerActivity1 agent.webPageList.appendItem -object $my_PageObject3

set my_PageObject4 [::IxLoad new PageObject]
$my_PageObject4 config \
-Md5Option                                0 \
-payloadSize                             "32768" \
-customPayloadId                          -1 \
-payloadType                              "range" \
-payloadFile                              "<specify file>" \
-page                                     "/32k.html" \
-response                                $200_OK

$Activity_newServerActivity1 agent.webPageList.appendItem -object $my_PageObject4

set my_PageObject5 [::IxLoad new PageObject]
$my_PageObject5 config \
-Md5Option                                0 \
-payloadSize                             "65536" \
-customPayloadId                          -1 \
-payloadType                              "range" \
-payloadFile                              "<specify file>" \
-page                                     "/64k.html" \
-response                                $200_OK

$Activity_newServerActivity1 agent.webPageList.appendItem -object $my_PageObject5

set my_PageObject6 [::IxLoad new PageObject]
$my_PageObject6 config \
-Md5Option                                0 \
-payloadSize                             "131072" \
-customPayloadId                          -1 \
-payloadType                              "range" \
-payloadFile                              "<specify file>" \
-page                                     "/128k.html" \
-response                                $200_OK

$Activity_newServerActivity1 agent.webPageList.appendItem -object $my_PageObject6

set my_PageObject7 [::IxLoad new PageObject]
```

```

$my_PageObject7 config \
-Md5Option          0 \
-payloadSize        "262144" \
-customPayloadId    -1 \
-payloadType        "range" \
-payloadFile        "<specify file>" \
-page               "/256k.html" \
-response           "$200_OK"

$Activity_newServerActivity1 agent.webPageList.appendItem -object $my_PageObject7

set my_PageObject8 [::IxLoad new PageObject]
$my_PageObject8 config \
-Md5Option          0 \
-payloadSize        "524288" \
-customPayloadId    -1 \
-payloadType        "range" \
-payloadFile        "<specify file>" \
-page               "/512k.html" \
-response           "$200_OK"

$Activity_newServerActivity1 agent.webPageList.appendItem -object $my_PageObject8

set my_PageObject9 [::IxLoad new PageObject]
$my_PageObject9 config \
-Md5Option          0 \
-payloadSize        "1048576" \
-customPayloadId    -1 \
-payloadType        "range" \
-payloadFile        "<specify file>" \
-page               "/1024k.html" \
-response           "$200_OK"

$Activity_newServerActivity1 agent.webPageList.appendItem -object $my_PageObject9

$Activity_newServerActivity1 agent.cookieList.clear

set UserCookie [::IxLoad new CookieObject]
$UserCookie config \
-mode               3 \
-type               2 \
-name               "UserCookie" \
-description        "Name of User"

$UserCookie cookieContentList.clear

set firstName [::IxLoad new ixCookieContent]
$firstName config \
-domain            "" \
-name              "firstName" \
-maxAge            "" \
-value             "Joe" \
-other             "" \

```

```
-path                ""

$UserCookie cookieContentList.appendItem -object $firstName

set lastName [::IxLoad new ixCookieContent]
$lastName config \
-domain           "" \
-name             "lastName" \
-maxAge          "" \
-value           "Smith" \
-other           "" \
-path            ""

$UserCookie cookieContentList.appendItem -object $lastName

$Activity_newServerActivity1 agent.cookieList.appendItem -object $UserCookie

set LoginCookie [::IxLoad new CookieObject]
$LoginCookie config \
-mode            2 \
-type           2 \
-name           "LoginCookie" \
-description    "Login name and password"

$LoginCookie cookieContentList.clear

set name [::IxLoad new ixCookieContent]
$name config \
-domain         "" \
-name          "name" \
-maxAge        "" \
-value         "joesmith" \
-other         "" \
-path          ""

$LoginCookie cookieContentList.appendItem -object $name

set password [::IxLoad new ixCookieContent]
$password config \
-domain        "" \
-name         "password" \
-maxAge       "" \
-value        "foobar" \
-other        "" \
-path         ""

$LoginCookie cookieContentList.appendItem -object $password

$Activity_newServerActivity1 agent.cookieList.appendItem -object $LoginCookie

$Activity_newServerActivity1 agent.customPayloadList.clear

set AsciiCustomPayload [::IxLoad new CustomPayloadObject]
```

```

$AsciiCustomPayload config \
-repeat                false \
-name                 "AsciiCustomPayload" \
-asciiPayloadValue   "Ixia-Ixload-Http-Server-Custom-Payload"
\
-payloadmode         0 \
-offset              1 \
-hexPayloadValue     "" \
-payloadPosition     "Start With" \
-id                  0

$Activity_newServerActivity1 agent.customPayloadList.appendItem -object $As-
ciiCustomPayload

set HexCustomPayload [::IxLoad new CustomPayloadObject]
$HexCustomPayload config \
-repeat                0 \
-name                 "HexCustomPayload" \
-asciiPayloadValue   "" \
-payloadmode         1 \
-offset              1 \
-hexPayloadValue     "49 78 69 61 2d 49 78 6c 6f 61 64 2d 48
74 74 70 2d 53 65 72 76 65 72 2d 43 75 73 74 6f 6d 2d 50 61 79 6c 6f 61 64" \
-payloadPosition     "Start With" \
-id                  1

$Activity_newServerActivity1 agent.customPayloadList.appendItem -object $HexCus-
tomPayload

$Activity_newServerActivity1 agent.responseHeaderList.clear

set 200_OK1 [::IxLoad new ResponseHeader]
$200_OK1 config \
-mimeType             "text/plain" \
-expirationMode       0 \
-code                 "200" \
-name                 "200_OK" \
-lastModifiedMode     1 \
-lastModifiedIncrementEnable false \
-lastModifiedDateTimeValue "2005/02/02 21:55:04" \
-lastModifiedIncrementFor 1 \
-expirationDateTimeValue "2005/03/04 21:55:04" \
-expirationAfterRequestValue 3600 \
-expirationAfterLastModifiedValue 3600 \
-lastModifiedIncrementBy 5 \
-description           "OK"

$200_OK1 responseList.clear

$Activity_newServerActivity1 agent.responseHeaderList.appendItem -object $200_OK1

set 404_PageNotFound [::IxLoad new ResponseHeader]

```

```
$404_PageNotFound config \  
-mimeType "text/plain" \  
-expirationMode 0 \  
-code "404" \  
-name "404_PageNotFound" \  
-lastModifiedMode 1 \  
-lastModifiedIncrementEnable false \  
-lastModifiedDateValue "2005/02/02 21:55:04" \  
-lastModifiedIncrementFor 1 \  
-expirationDateValue "2005/03/04 21:55:04" \  
-expirationAfterRequestValue 3600 \  
-expirationAfterLastModifiedValue 3600 \  
-lastModifiedIncrementBy 5 \  
-description "Page not found"
```

```
$404_PageNotFound responseList.clear
```

```
$Activity_newServerActivity1 agent.responseHeaderList.appendItem -object $404_  
PageNotFound
```

```
#####  
# Network server network of NetTraffic HTTP server@server network  
#####  
set server_network [::IxLoad new ixNetworkGroup $chassisChain]  
$server_network config \  
-comment "" \  
-name "server network" \  
-macMappingMode 0 \  
-linkLayerOptions 0
```

```
$server_network globalPlugins.clear
```

```
set Filter_1 [::IxLoad new ixNetFilterPlugin]  
# ixNet objects needs to be added in the list before they are configured!  
$server_network globalPlugins.appendItem -object $Filter_1
```

```
$Filter_1 config \  
-all false \  
-pppoecontrol false \  
-isis false \  
-name "Filter-1" \  
-auto true \  
-udp "" \  
-tcp "" \  
-mac "" \  
-pppoenetwork false \  
-ip "" \  
-icmp ""
```

```
set GratARP_1 [::IxLoad new ixNetGratArpPlugin]  
# ixNet objects needs to be added in the list before they are configured!  
$server_network globalPlugins.appendItem -object $GratARP_1
```



```

$GratARP_1 config \
-enabled                true \
-name                   "GratARP-1"

set TCP_1 [::IxLoad new ixNetTCPPlugin]
# ixNet objects needs to be added in the list before they are configured!
$server_network globalPlugins.appendItem -object $TCP_1

$TCP_1 config \
-tcp_bic                0 \
-tcp_tw_recycle         true \
-tcp_retries2           15 \
-tcp_retries1           3 \
-tcp_keepalive_time     9 \
-tcp_moderate_rcvbuf    0 \
-tcp_rfc1337            false \
-tcp_ipfrag_time        30 \
-tcp_rto_max            60000 \
-tcp_vegas_alpha         2 \
-tcp_ecn                 false \
-tcp_westwood           0 \
-tcp_rto_min            1000 \
-tcp_reordering         3 \
-tcp_vegas_cong_avoid    0 \
-tcp_keepalive_intvl    7200 \
-tcp_rmem_max           262144 \
-tcp_orphan_retries     0 \
-tcp_max_tw_buckets     180000 \
-tcp_wmem_default       4096 \
-tcp_low_latency        0 \
-tcp_rmem_min           4096 \
-tcp_adv_win_scale      2 \
-tcp_wmem_min           4096 \
-tcp_port_min           1024 \
-tcp_stdurg             false \
-tcp_port_max           65535 \
-tcp_fin_timeout        60 \
-tcp_no_metrics_save    false \
-tcp_dsack              true \
-tcp_mem_high           49152 \
-tcp_frto               0 \
-tcp_app_win            31 \
-ip_no_pmtu_disc        false \
-tcp_window_scaling     false \
-tcp_max_orphans        8192 \
-tcp_mem_pressure       32768 \
-tcp_syn_retries        5 \
-name                   "TCP-1" \
-tcp_max_syn_backlog    1024 \
-tcp_mem_low            24576 \
-tcp_fack               true \
-tcp_retrans_collapse   true \
-tcp_rmem_default       4096 \

```

```
-tcp_keepalive_probes          75 \  
-tcp_abort_on_overflow        false \  
-tcp_tw_reuse                  false \  
-tcp_wmem_max                  262144 \  
-tcp_vegas_gamma               2 \  
-tcp_synack_retries           5 \  
-tcp_timestamps                true \  
-tcp_vegas_beta                 6 \  
-tcp_sack                       true \  
-tcp_bic_fast_convergence       1 \  
-tcp_bic_low_window            14  
  
set DNS_1 [::IxLoad new ixNetDnsPlugin]  
# ixNet objects needs to be added in the list before they are configured!  
$server_network globalPlugins.appendItem -object $DNS_1  
  
$DNS_1 config \  
-domain                        "" \  
-name                          "DNS-1" \  
-timeout                       30000  
  
$DNS_1 hostList.clear  
  
$DNS_1 searchList.clear  
  
$DNS_1 nameServerList.clear  
  
set Settings_1 [::IxLoad new ixNetIxLoadSettingsPlugin]  
# ixNet objects needs to be added in the list before they are configured!  
$server_network globalPlugins.appendItem -object $Settings_1  
  
$Settings_1 config \  
-teardownInterfaceWithUser     false \  
-name                          "Settings-1" \  
-interfaceBehavior              0  
  
set Ethernet_2 [$server_network getL1Plugin]  
  
set my_ixNetEthernetELMPlugin1 [::IxLoad new ixNetEthernetELMPlugin]  
$my_ixNetEthernetELMPlugin1 config \  
-negotiationType                "master" \  
-negotiateMasterSlave           true  
  
$Ethernet_2 config \  
-advertise10Full                 true \  
-name                            "Ethernet-2" \  
-autoNegotiate                   true \  
-advertise100Half                true \  
-advertise10Half                 true \  
-speed                          "k100FD" \  
-advertise1000Full               true \  
-advertise100Full                true \  
-cardElm                         $my_ixNetEthernetELMPlugin1
```

```

$Ethernet_2 childrenList.clear

set MAC_VLAN_2 [::IxLoad new ixNetL2EthernetPlugin]
# ixNet objects needs to be added in the list before they are configured!
$Ethernet_2 childrenList.appendItem -object $MAC_VLAN_2

$MAC_VLAN_2 config \
-name                          "MAC/VLAN-2"

$MAC_VLAN_2 childrenList.clear

set IP_2 [::IxLoad new ixNetIPv4V6Plugin]
# ixNet objects needs to be added in the list before they are configured!
$MAC_VLAN_2 childrenList.appendItem -object $IP_2

$IP_2 config \
-name                          "IP-2"

$IP_2 childrenList.clear

$IP_2 extensionList.clear

$MAC_VLAN_2 extensionList.clear

$Ethernet_2 extensionList.clear

#####
# Setting the ranges starting with the plugin on top of the stack
#####
$IP_2 rangeList.clear

set IP_R2 [::IxLoad new ixNetIPv4V6Range]
# ixNet objects needs to be added in the list before they are configured!
$IP_2 rangeList.appendItem -object $IP_R2

$IP_R2 config \
-count                          1 \
-name                          "IP-R2" \
-gatewayAddress                 "0.0.0.0" \
-enabled                        true \
-autoMacGeneration              true \
-mss                            1460 \
-incrementBy                    "0.0.0.1" \
-prefix                         16 \
-gatewayIncrement               "0.0.0.0" \
-gatewayIncrementMode           "perSubnet" \
-generateStatistics             false \
-ipAddress                      "198.18.1.1" \
-ipType                         "IPv4"

set MAC_R2 [$IP_R2 getLowerRelatedRange "MacRange"]

```

```
$MAC_R2 config \  
-count 1 \  
-name "MAC-R2" \  
-enabled true \  
-mtu 1500 \  
-mac "00:C6:12:01:01:00" \  
-incrementBy "00:00:00:00:00:01"  
  
set VLAN_R2 [$IP_R2 getLowerRelatedRange "VlanIdRange"]  
  
$VLAN_R2 config \  
-incrementStep 1 \  
-uniqueCount 4094 \  
-name "VLAN-R1" \  
-innerIncrement 1 \  
-innerUniqueCount 4094 \  
-enabled false \  
-innerFirstId 1 \  
-increment 1 \  
-priority 0 \  
-firstId 1 \  
-innerIncrementStep 1 \  
-idIncrMode 1 \  
-innerEnable false \  
-innerPriority 0  
  
$HTTP_server_server_network config \  
-enable 1 \  
-network $server_network  
  
$HTTP_server_server_network traffic.config \  
-name "HTTP server"  
  
$Server elementList.appendItem -object $HTTP_server_server_network  
  
$TrafficFlow1 columnList.appendItem -object $Server  
  
$TrafficFlow1 links.clear  
  
$Test1 scenarioList.appendItem -object $TrafficFlow1  
  
#####  
# Destination newServerActivity1 for newClientActivity1  
#####  
set destination [$HTTP_client_client_network getDestinationForActivity "newCli-  
entActivity1" "HTTP server_newServerActivity1"]  
$destination config \  
-portMapPolicy "portMesh"  
  
#####  
# Session Specific Settings  
#####  
set my_ixNetMacSessionData [$Test1 getSessionSpecificData "L2EthernetPlugin"]
```

```

$my_ixNetMacSessionData config \
-duplicateCheckingScope                2

set my_ixNetIpSessionData [$Test1 getSessionSpecificData "IPv4V6Plugin"]
$my_ixNetIpSessionData config \
-duplicateCheckingScope                2

#####
# Create the test controller to run the test
#####
set testController [::IxLoad new ixTestController -outputDir True]

$testController setResultDir "RESULTS/simpleHTTP"
set NS statCollectorUtils

set test_server_handle [$testController getTestServerHandle]
${NS}::Initialize -testServerHandle $test_server_handle

${NS}::ClearStats
$Test1 clearGridStats

set HTTP_Client_Per_URL_StatList { \
{"HTTP Client Per URL" "HTTP Aborted After Request" "kMax"} \
{"HTTP Client Per URL" "HTTP Aborted Before Request" "kMax"} \
{"HTTP Client Per URL" "HTTP Requests Failed" "kMax"} \
{"HTTP Client Per URL" "HTTP Requests Failed (400)" "kMax"} \
{"HTTP Client Per URL" "HTTP Requests Failed (401)" "kMax"} \
{"HTTP Client Per URL" "HTTP Requests Failed (403)" "kMax"} \
{"HTTP Client Per URL" "HTTP Requests Failed (404)" "kMax"} \
{"HTTP Client Per URL" "HTTP Requests Failed (407)" "kMax"} \
{"HTTP Client Per URL" "HTTP Requests Failed (408)" "kMax"} \
{"HTTP Client Per URL" "HTTP Requests Failed (4xx other)" "kMax"} \
{"HTTP Client Per URL" "HTTP Requests Failed (4xx)" "kMax"} \
{"HTTP Client Per URL" "HTTP Requests Failed (505)" "kMax"} \
{"HTTP Client Per URL" "HTTP Requests Failed (5xx other)" "kMax"} \
{"HTTP Client Per URL" "HTTP Requests Failed (5xx)" "kMax"} \
{"HTTP Client Per URL" "HTTP Requests Failed (Aborted)" "kMax"} \
{"HTTP Client Per URL" "HTTP Requests Failed (Bad Header)" "kMax"} \
{"HTTP Client Per URL" "HTTP Requests Failed (Read)" "kMax"} \
{"HTTP Client Per URL" "HTTP Requests Failed (Timeout)" "kMax"} \
{"HTTP Client Per URL" "HTTP Requests Failed (Write)" "kMax"} \
{"HTTP Client Per URL" "HTTP Requests Sent" "kMax"} \
{"HTTP Client Per URL" "HTTP Requests Successful" "kMax"} \
{"HTTP Client Per URL" "HTTP Responses Received With Match" "kMax"} \
{"HTTP Client Per URL" "HTTP Responses Received Without Match" "kMax"} \
}

set HTTP_Client_StatList { \
{"HTTP Client" "Client Hello Sent" "kMax"} \
{"HTTP Client" "HTTP Aborted After Request" "kMax"} \
{"HTTP Client" "HTTP Aborted Before Request" "kMax"} \
{"HTTP Client" "HTTP Bytes" "kMax"} \
{"HTTP Client" "HTTP Bytes Received" "kMax"} \
}

```

```
{"HTTP Client" "HTTP Bytes Sent" "kMax"} \  
{"HTTP Client" "HTTP Concurrent Connections" "kMax"} \  
{"HTTP Client" "HTTP Connect Time (us)" "kAverageRate"} \  
{"HTTP Client" "HTTP Connection Attempts" "kMax"} \  
{"HTTP Client" "HTTP Connections" "kMax"} \  
{"HTTP Client" "HTTP Content Bytes Received" "kMax"} \  
{"HTTP Client" "HTTP Content Bytes Sent" "kMax"} \  
{"HTTP Client" "HTTP Cookie headers Rejected - (Memory Overflow)" "kMax"} \  
{"HTTP Client" "HTTP Cookies Received" "kMax"} \  
{"HTTP Client" "HTTP Cookies Rejected" "kMax"} \  
{"HTTP Client" "HTTP Cookies Rejected - (Cookiejar Overflow)" "kMax"} \  
{"HTTP Client" "HTTP Cookies Rejected - (Domain Match Failed)" "kMax"} \  
{"HTTP Client" "HTTP Cookies Rejected - (Path Match Failed)" "kMax"} \  
{"HTTP Client" "HTTP Cookies Rejected - (Probabilistic Reject)" "kMax"} \  
{"HTTP Client" "HTTP Cookies Sent" "kMax"} \  
{"HTTP Client" "HTTP Requests Failed" "kMax"} \  
{"HTTP Client" "HTTP Requests Failed (400)" "kMax"} \  
{"HTTP Client" "HTTP Requests Failed (401)" "kMax"} \  
{"HTTP Client" "HTTP Requests Failed (403)" "kMax"} \  
{"HTTP Client" "HTTP Requests Failed (404)" "kMax"} \  
{"HTTP Client" "HTTP Requests Failed (407)" "kMax"} \  
{"HTTP Client" "HTTP Requests Failed (408)" "kMax"} \  
{"HTTP Client" "HTTP Requests Failed (4xx other)" "kMax"} \  
{"HTTP Client" "HTTP Requests Failed (4xx)" "kMax"} \  
{"HTTP Client" "HTTP Requests Failed (505)" "kMax"} \  
{"HTTP Client" "HTTP Requests Failed (5xx other)" "kMax"} \  
{"HTTP Client" "HTTP Requests Failed (5xx)" "kMax"} \  
{"HTTP Client" "HTTP Requests Failed (Aborted)" "kMax"} \  
{"HTTP Client" "HTTP Requests Failed (Bad Header)" "kMax"} \  
{"HTTP Client" "HTTP Requests Failed (Read)" "kMax"} \  
{"HTTP Client" "HTTP Requests Failed (Timeout)" "kMax"} \  
{"HTTP Client" "HTTP Requests Failed (Write)" "kMax"} \  
{"HTTP Client" "HTTP Requests Sent" "kMax"} \  
{"HTTP Client" "HTTP Requests Successful" "kMax"} \  
{"HTTP Client" "HTTP Session Timeouts (408)" "kMax"} \  
{"HTTP Client" "HTTP Sessions Rejected (503)" "kMax"} \  
{"HTTP Client" "HTTP Simulated Users" "kSum"} \  
{"HTTP Client" "HTTP Time To First Byte (us)" "kAverageRate"} \  
{"HTTP Client" "HTTP Time To Last Byte (us)" "kAverageRate"} \  
{"HTTP Client" "HTTP Transactions" "kMax"} \  
{"HTTP Client" "HTTP Transactions Active" "kMax"} \  
{"HTTP Client" "HTTP Users Active" "kMax"} \  
{"HTTP Client" "SSL Alerts Received" "kMax"} \  
{"HTTP Client" "SSL Alerts Received (access_denied)" "kMax"} \  
{"HTTP Client" "SSL Alerts Received (bad_certificate)" "kMax"} \  
{"HTTP Client" "SSL Alerts Received (bad_record_mac)" "kMax"} \  
{"HTTP Client" "SSL Alerts Received (certificate_expired)" "kMax"} \  
{"HTTP Client" "SSL Alerts Received (certificate_revoked)" "kMax"} \  
{"HTTP Client" "SSL Alerts Received (certificate_unknown)" "kMax"} \  
{"HTTP Client" "SSL Alerts Received (close_notify)" "kMax"} \  
{"HTTP Client" "SSL Alerts Received (decode_error)" "kMax"} \  
{"HTTP Client" "SSL Alerts Received (decompression_failure)" "kMax"} \  
{"HTTP Client" "SSL Alerts Received (decrypt_error)" "kMax"} \  

```

```

{"HTTP Client" "SSL Alerts Received (decryption_failed)" "kMax"} \
{"HTTP Client" "SSL Alerts Received (export_restriction)" "kMax"} \
{"HTTP Client" "SSL Alerts Received (handshake_failure)" "kMax"} \
{"HTTP Client" "SSL Alerts Received (illegal_parameter)" "kMax"} \
{"HTTP Client" "SSL Alerts Received (insufficient_security)" "kMax"} \
{"HTTP Client" "SSL Alerts Received (internal_error)" "kMax"} \
{"HTTP Client" "SSL Alerts Received (no_certificate)" "kMax"} \
{"HTTP Client" "SSL Alerts Received (no_renegotiation)" "kMax"} \
{"HTTP Client" "SSL Alerts Received (protocol_version)" "kMax"} \
{"HTTP Client" "SSL Alerts Received (record_overflow)" "kMax"} \
{"HTTP Client" "SSL Alerts Received (unexpected_message)" "kMax"} \
{"HTTP Client" "SSL Alerts Received (unknown_ca)" "kMax"} \
{"HTTP Client" "SSL Alerts Received (unsupported_certificate)" "kMax"} \
{"HTTP Client" "SSL Alerts Received (user_canceled)" "kMax"} \
{"HTTP Client" "SSL Alerts Sent" "kMax"} \
{"HTTP Client" "SSL Alerts Sent (access_denied)" "kMax"} \
{"HTTP Client" "SSL Alerts Sent (bad_certificate)" "kMax"} \
{"HTTP Client" "SSL Alerts Sent (bad_record_mac)" "kMax"} \
{"HTTP Client" "SSL Alerts Sent (certificate_expired)" "kMax"} \
{"HTTP Client" "SSL Alerts Sent (certificate_revoked)" "kMax"} \
{"HTTP Client" "SSL Alerts Sent (certificate_unknown)" "kMax"} \
{"HTTP Client" "SSL Alerts Sent (close_notify)" "kMax"} \
{"HTTP Client" "SSL Alerts Sent (decode_error)" "kMax"} \
{"HTTP Client" "SSL Alerts Sent (decompression_failure)" "kMax"} \
{"HTTP Client" "SSL Alerts Sent (decrypt_error)" "kMax"} \
{"HTTP Client" "SSL Alerts Sent (decryption_failed)" "kMax"} \
{"HTTP Client" "SSL Alerts Sent (export_restriction)" "kMax"} \
{"HTTP Client" "SSL Alerts Sent (handshake_failure)" "kMax"} \
{"HTTP Client" "SSL Alerts Sent (illegal_parameter)" "kMax"} \
{"HTTP Client" "SSL Alerts Sent (insufficient_security)" "kMax"} \
{"HTTP Client" "SSL Alerts Sent (internal_error)" "kMax"} \
{"HTTP Client" "SSL Alerts Sent (no_certificate)" "kMax"} \
{"HTTP Client" "SSL Alerts Sent (no_renegotiation)" "kMax"} \
{"HTTP Client" "SSL Alerts Sent (protocol_version)" "kMax"} \
{"HTTP Client" "SSL Alerts Sent (record_overflow)" "kMax"} \
{"HTTP Client" "SSL Alerts Sent (unexpected_message)" "kMax"} \
{"HTTP Client" "SSL Alerts Sent (unknown_ca)" "kMax"} \
{"HTTP Client" "SSL Alerts Sent (unsupported_certificate)" "kMax"} \
{"HTTP Client" "SSL Alerts Sent (user_canceled)" "kMax"} \
{"HTTP Client" "SSL Bytes Received" "kMax"} \
{"HTTP Client" "SSL Bytes Sent" "kMax"} \
{"HTTP Client" "SSL Concurrent Sessions" "kMax"} \
{"HTTP Client" "SSL Errors Received" "kMax"} \
{"HTTP Client" "SSL Errors Received (bad certificate)" "kMax"} \
{"HTTP Client" "SSL Errors Received (no certificate)" "kMax"} \
{"HTTP Client" "SSL Errors Received (no cipher)" "kMax"} \
{"HTTP Client" "SSL Errors Received (undefined error)" "kMax"} \
{"HTTP Client" "SSL Errors Received (unsupported certificate)" "kMax"} \
{"HTTP Client" "SSL Errors Sent" "kMax"} \
{"HTTP Client" "SSL Errors Sent (bad certificate)" "kMax"} \
{"HTTP Client" "SSL Errors Sent (no certificate)" "kMax"} \
{"HTTP Client" "SSL Errors Sent (no cipher)" "kMax"} \
{"HTTP Client" "SSL Errors Sent (undefined error)" "kMax"} \

```

```

{"HTTP Client" "SSL Errors Sent (unsupported certificate)" "kMax"} \
{"HTTP Client" "SSL Negotiation Finished Successfully" "kMax"} \
{"HTTP Client" "SSL Session Reuse Failed" "kMax"} \
{"HTTP Client" "SSL Session Reuse Success" "kMax"} \
{"HTTP Client" "SSL Throughput Bytes" "kMax"} \
{"HTTP Client" "Server Hello Received" "kMax"} \
{"HTTP Client" "TCP Accept Queue Entries" "kMax"} \
{"HTTP Client" "TCP Connection Requests Failed" "kMax"} \
{"HTTP Client" "TCP Connections Established" "kMax"} \
{"HTTP Client" "TCP Connections in CLOSE STATE" "kMax"} \
{"HTTP Client" "TCP Connections in CLOSE-WAIT State" "kMax"} \
{"HTTP Client" "TCP Connections in CLOSING State" "kMax"} \
{"HTTP Client" "TCP Connections in ESTABLISHED State" "kMax"} \
{"HTTP Client" "TCP Connections in FIN-WAIT-1 State" "kMax"} \
{"HTTP Client" "TCP Connections in FIN-WAIT-2 State" "kMax"} \
{"HTTP Client" "TCP Connections in LAST-ACK State" "kMax"} \
{"HTTP Client" "TCP Connections in LISTENING State" "kMax"} \
{"HTTP Client" "TCP Connections in SYN-RECEIVED State" "kMax"} \
{"HTTP Client" "TCP Connections in SYN-SENT State" "kMax"} \
{"HTTP Client" "TCP Connections in TIME-WAIT State" "kMax"} \
{"HTTP Client" "TCP FIN Received" "kMax"} \
{"HTTP Client" "TCP FIN Sent" "kMax"} \
{"HTTP Client" "TCP FIN-ACK Received" "kMax"} \
{"HTTP Client" "TCP FIN-ACK Sent" "kMax"} \
{"HTTP Client" "TCP Listen Queue Drops" "kMax"} \
{"HTTP Client" "TCP Resets Received" "kMax"} \
{"HTTP Client" "TCP Resets Sent" "kMax"} \
{"HTTP Client" "TCP Retries" "kMax"} \
{"HTTP Client" "TCP SYN Failed" "kMax"} \
{"HTTP Client" "TCP SYN Sent" "kMax"} \
{"HTTP Client" "TCP SYN-ACK Sent" "kMax"} \
{"HTTP Client" "TCP SYN_SYN-ACK Received" "kMax"} \
{"HTTP Client" "TCP Timeouts" "kMax"} \
}

set HTTP_Server_Per_URL_StatList { \
{"HTTP Server Per URL" "HTTP Requests Failed" "kMax"} \
{"HTTP Server Per URL" "HTTP Requests Failed (404)" "kMax"} \
{"HTTP Server Per URL" "HTTP Requests Failed (50x)" "kMax"} \
{"HTTP Server Per URL" "HTTP Requests Failed (Write Error)" "kMax"} \
{"HTTP Server Per URL" "HTTP Requests Received" "kMax"} \
{"HTTP Server Per URL" "HTTP Requests Successful" "kMax"} \
}

set HTTP_Server_StatList { \
{"HTTP Server" "Client Hello Received" "kMax"} \
{"HTTP Server" "HTTP Bytes Received" "kMax"} \
{"HTTP Server" "HTTP Bytes Sent" "kMax"} \
{"HTTP Server" "HTTP Content Bytes Received" "kMax"} \
{"HTTP Server" "HTTP Content Bytes Sent" "kMax"} \
{"HTTP Server" "HTTP Cookies Received" "kMax"} \
{"HTTP Server" "HTTP Cookies Received With Matching ServerID" "kMax"} \
{"HTTP Server" "HTTP Cookies Received With Non-matching ServerID" "kMax"} \
}

```



```

{"HTTP Server" "HTTP Cookies Sent" "kMax"} \
{"HTTP Server" "HTTP Requests Failed" "kMax"} \
{"HTTP Server" "HTTP Requests Failed (404)" "kMax"} \
{"HTTP Server" "HTTP Requests Failed (50x)" "kMax"} \
{"HTTP Server" "HTTP Requests Failed (Write Error)" "kMax"} \
{"HTTP Server" "HTTP Requests Received" "kMax"} \
{"HTTP Server" "HTTP Requests Successful" "kMax"} \
{"HTTP Server" "HTTP Session Timeouts (408)" "kMax"} \
{"HTTP Server" "HTTP Sessions Rejected (503)" "kMax"} \
{"HTTP Server" "HTTP Transactions Active" "kMax"} \
{"HTTP Server" "SSL Alerts Received" "kMax"} \
{"HTTP Server" "SSL Alerts Received (access_denied)" "kMax"} \
{"HTTP Server" "SSL Alerts Received (bad_certificate)" "kMax"} \
{"HTTP Server" "SSL Alerts Received (bad_record_mac)" "kMax"} \
{"HTTP Server" "SSL Alerts Received (certificate_expired)" "kMax"} \
{"HTTP Server" "SSL Alerts Received (certificate_revoked)" "kMax"} \
{"HTTP Server" "SSL Alerts Received (certificate_unknown)" "kMax"} \
{"HTTP Server" "SSL Alerts Received (close_notify)" "kMax"} \
{"HTTP Server" "SSL Alerts Received (decode_error)" "kMax"} \
{"HTTP Server" "SSL Alerts Received (decompression_failure)" "kMax"} \
{"HTTP Server" "SSL Alerts Received (decrypt_error)" "kMax"} \
{"HTTP Server" "SSL Alerts Received (decryption_failed)" "kMax"} \
{"HTTP Server" "SSL Alerts Received (export_restriction)" "kMax"} \
{"HTTP Server" "SSL Alerts Received (handshake_failure)" "kMax"} \
{"HTTP Server" "SSL Alerts Received (illegal_parameter)" "kMax"} \
{"HTTP Server" "SSL Alerts Received (insufficient_security)" "kMax"} \
{"HTTP Server" "SSL Alerts Received (internal_error)" "kMax"} \
{"HTTP Server" "SSL Alerts Received (no_certificate)" "kMax"} \
{"HTTP Server" "SSL Alerts Received (no_renegotiation)" "kMax"} \
{"HTTP Server" "SSL Alerts Received (protocol_version)" "kMax"} \
{"HTTP Server" "SSL Alerts Received (record_overflow)" "kMax"} \
{"HTTP Server" "SSL Alerts Received (unexpected_message)" "kMax"} \
{"HTTP Server" "SSL Alerts Received (unknown_ca)" "kMax"} \
{"HTTP Server" "SSL Alerts Received (unsupported_certificate)" "kMax"} \
{"HTTP Server" "SSL Alerts Received (user_canceled)" "kMax"} \
{"HTTP Server" "SSL Alerts Sent" "kMax"} \
{"HTTP Server" "SSL Alerts Sent (access_denied)" "kMax"} \
{"HTTP Server" "SSL Alerts Sent (bad_certificate)" "kMax"} \
{"HTTP Server" "SSL Alerts Sent (bad_record_mac)" "kMax"} \
{"HTTP Server" "SSL Alerts Sent (certificate_expired)" "kMax"} \
{"HTTP Server" "SSL Alerts Sent (certificate_revoked)" "kMax"} \
{"HTTP Server" "SSL Alerts Sent (certificate_unknown)" "kMax"} \
{"HTTP Server" "SSL Alerts Sent (close_notify)" "kMax"} \
{"HTTP Server" "SSL Alerts Sent (decode_error)" "kMax"} \
{"HTTP Server" "SSL Alerts Sent (decompression_failure)" "kMax"} \
{"HTTP Server" "SSL Alerts Sent (decrypt_error)" "kMax"} \
{"HTTP Server" "SSL Alerts Sent (decryption_failed)" "kMax"} \
{"HTTP Server" "SSL Alerts Sent (export_restriction)" "kMax"} \
{"HTTP Server" "SSL Alerts Sent (handshake_failure)" "kMax"} \
{"HTTP Server" "SSL Alerts Sent (illegal_parameter)" "kMax"} \
{"HTTP Server" "SSL Alerts Sent (insufficient_security)" "kMax"} \
{"HTTP Server" "SSL Alerts Sent (internal_error)" "kMax"} \
{"HTTP Server" "SSL Alerts Sent (no_certificate)" "kMax"} \

```

```
{ "HTTP Server" "SSL Alerts Sent (no_renegotiation)" "kMax" } \  
{ "HTTP Server" "SSL Alerts Sent (protocol_version)" "kMax" } \  
{ "HTTP Server" "SSL Alerts Sent (record_overflow)" "kMax" } \  
{ "HTTP Server" "SSL Alerts Sent (unexpected_message)" "kMax" } \  
{ "HTTP Server" "SSL Alerts Sent (unknown_ca)" "kMax" } \  
{ "HTTP Server" "SSL Alerts Sent (unsupported_certificate)" "kMax" } \  
{ "HTTP Server" "SSL Alerts Sent (user_canceled)" "kMax" } \  
{ "HTTP Server" "SSL Bytes Received" "kMax" } \  
{ "HTTP Server" "SSL Bytes Sent" "kMax" } \  
{ "HTTP Server" "SSL Concurrent Sessions" "kMax" } \  
{ "HTTP Server" "SSL Errors Received" "kMax" } \  
{ "HTTP Server" "SSL Errors Received (bad_certificate)" "kMax" } \  
{ "HTTP Server" "SSL Errors Received (no_certificate)" "kMax" } \  
{ "HTTP Server" "SSL Errors Received (no_cipher)" "kMax" } \  
{ "HTTP Server" "SSL Errors Received (undefined_error)" "kMax" } \  
{ "HTTP Server" "SSL Errors Received (unsupported_certificate)" "kMax" } \  
{ "HTTP Server" "SSL Errors Sent" "kMax" } \  
{ "HTTP Server" "SSL Errors Sent (bad_certificate)" "kMax" } \  
{ "HTTP Server" "SSL Errors Sent (no_certificate)" "kMax" } \  
{ "HTTP Server" "SSL Errors Sent (no_cipher)" "kMax" } \  
{ "HTTP Server" "SSL Errors Sent (undefined_error)" "kMax" } \  
{ "HTTP Server" "SSL Errors Sent (unsupported_certificate)" "kMax" } \  
{ "HTTP Server" "SSL Negotiation Finished Successfully" "kMax" } \  
{ "HTTP Server" "SSL Session Reuse Failed" "kMax" } \  
{ "HTTP Server" "SSL Session Reuse Success" "kMax" } \  
{ "HTTP Server" "SSL Throughput Bytes" "kMax" } \  
{ "HTTP Server" "Server Hello Sent" "kMax" } \  
{ "HTTP Server" "TCP Accept Queue Entries" "kMax" } \  
{ "HTTP Server" "TCP Connection Requests Failed" "kMax" } \  
{ "HTTP Server" "TCP Connections Established" "kMax" } \  
{ "HTTP Server" "TCP Connections in CLOSE STATE" "kMax" } \  
{ "HTTP Server" "TCP Connections in CLOSE-WAIT State" "kMax" } \  
{ "HTTP Server" "TCP Connections in CLOSING State" "kMax" } \  
{ "HTTP Server" "TCP Connections in ESTABLISHED State" "kMax" } \  
{ "HTTP Server" "TCP Connections in FIN-WAIT-1 State" "kMax" } \  
{ "HTTP Server" "TCP Connections in FIN-WAIT-2 State" "kMax" } \  
{ "HTTP Server" "TCP Connections in LAST-ACK State" "kMax" } \  
{ "HTTP Server" "TCP Connections in LISTENING State" "kMax" } \  
{ "HTTP Server" "TCP Connections in SYN-RECEIVED State" "kMax" } \  
{ "HTTP Server" "TCP Connections in SYN-SENT State" "kMax" } \  
{ "HTTP Server" "TCP Connections in TIME-WAIT State" "kMax" } \  
{ "HTTP Server" "TCP FIN Received" "kMax" } \  
{ "HTTP Server" "TCP FIN Sent" "kMax" } \  
{ "HTTP Server" "TCP FIN-ACK Received" "kMax" } \  
{ "HTTP Server" "TCP FIN-ACK Sent" "kMax" } \  
{ "HTTP Server" "TCP Listen Queue Drops" "kMax" } \  
{ "HTTP Server" "TCP Resets Received" "kMax" } \  
{ "HTTP Server" "TCP Resets Sent" "kMax" } \  
{ "HTTP Server" "TCP Retries" "kMax" } \  
{ "HTTP Server" "TCP SYN Failed" "kMax" } \  
{ "HTTP Server" "TCP SYN Sent" "kMax" } \  
{ "HTTP Server" "TCP SYN-ACK Sent" "kMax" } \  
{ "HTTP Server" "TCP SYN_SYN-ACK Received" "kMax" } \  

```

```

{"HTTP Server" "TCP Timeouts" "kMax"} \
}

set statList [concat \
$HTTP_Client_Per_URL_StatList \
$HTTP_Client_StatList \
$HTTP_Server_Per_URL_StatList \
$HTTP_Server_StatList \
]

set count 1
foreach statItem $statList {
set caption      [format "Watch_Stat_%s" $count]
set statSourceType [lindex $statItem 0]
set statName      [lindex $statItem 1]
set aggregationType [lindex $statItem 2]

${NS}::AddStat \
-caption          $caption \
-statSourceType   $statSourceType \
-statName         $statName \
-aggregationType $aggregationType \
-filterList       {}

incr count
}

proc ::my_stat_collector_command {args} {
puts "======"
puts "INCOMING STAT RECORD >>> $args"
puts "Len = [llength $args]"
puts [lindex $args 0]
puts [lindex $args 1]
puts "======"
}
${NS}::StartCollector -command ::my_stat_collector_command
$testController run $Test1

vwait ::ixTestControllerMonitor
puts $::ixTestControllerMonitor

${NS}::StopCollector

#####
# Cleanup
#####
# Release config is only strictly necessary if enableReleaseConfigAfterRun is 0.
$testController releaseConfigWaitFinish

::IxLoad delete $chassisChain
::IxLoad delete $Test1
::IxLoad delete $my_ixViewOptions
::IxLoad delete $TrafficFlow1

```

```
::IxLoad delete $Client
::IxLoad delete $HTTP_client_client_network
::IxLoad delete $Activity_newClientActivity1
::IxLoad delete $Timeline1
::IxLoad delete $my_ixHttpAction
::IxLoad delete $my_ixHTTPHeaderString
::IxLoad delete $my_ixHTTPHeaderString1
::IxLoad delete $my_ixHTTPHeaderString2
::IxLoad delete $my_ixHTTPHeaderString3
::IxLoad delete $client_network
::IxLoad delete $Filter
::IxLoad delete $GratARP
::IxLoad delete $TCP
::IxLoad delete $DNS
::IxLoad delete $Settings
::IxLoad delete $Ethernet_1
::IxLoad delete $my_ixNetEthernetELMPlugin
::IxLoad delete $MAC_VLAN_1
::IxLoad delete $IP_1
::IxLoad delete $IP_R1
::IxLoad delete $MAC_R1
::IxLoad delete $VLAN_R1
::IxLoad delete $DUT
::IxLoad delete $Server
::IxLoad delete $HTTP_server_server_network
::IxLoad delete $Activity_newServerActivity1
::IxLoad delete $_Match_Longest_
::IxLoad delete $my_PageObject
::IxLoad delete $200_OK
::IxLoad delete $my_PageObject1
::IxLoad delete $my_PageObject2
::IxLoad delete $my_PageObject3
::IxLoad delete $my_PageObject4
::IxLoad delete $my_PageObject5
::IxLoad delete $my_PageObject6
::IxLoad delete $my_PageObject7
::IxLoad delete $my_PageObject8
::IxLoad delete $my_PageObject9
::IxLoad delete $UserCookie
::IxLoad delete $firstName
::IxLoad delete $lastName
::IxLoad delete $LoginCookie
::IxLoad delete $name
::IxLoad delete $password
::IxLoad delete $AsciiCustomPayload
::IxLoad delete $HexCustomPayload
::IxLoad delete $200_OK1
::IxLoad delete $404_PageNotFound
::IxLoad delete $server_network
::IxLoad delete $Filter_1
::IxLoad delete $GratARP_1
::IxLoad delete $TCP_1
::IxLoad delete $DNS_1
```

```
::IxLoad delete $Settings_1
::IxLoad delete $Ethernet_2
::IxLoad delete $my_ixNetEthernetELMPlugin1
::IxLoad delete $MAC_VLAN_2
::IxLoad delete $IP_2
::IxLoad delete $IP_R2
::IxLoad delete $MAC_R2
::IxLoad delete $VLAN_R2
::IxLoad delete $destination
::IxLoad delete $my_ixNetMacSessionData
::IxLoad delete $my_ixNetIpSessionData
::IxLoad delete $testController

#####
# Disconnect / Release application lock
#####
}] {
puts $errorInfo
}

::IxLoad disconnect
```

This page intentionally left blank.

# IxLoad Tcl API Commands

This section describes the commands used to create the test infrastructure.

## ::IxLoad

::IxLoad-Top level IxLoad utility.

### SYNOPSIS

```
set object [::IxLoad new ixObject options]
```

### DESCRIPTION

The `ixLoad` command is the means by which other top level objects are created. Its `new` subcommand is documented in each of the created objects' commands. In addition, the `connect` and `disconnect` commands are used to connect to a remote server when running from a non-Windows client.

Although the `connect` operation is not needed for Windows clients, the `disconnect` operation is required. It is best to always use the following structure:

```
::IxLoad connect <server>
catch {
... remainder of program ...
} connectResults
::IxLoad disconnect
```

When operating on a Windows client, you can use `localhost` as a convenient placeholder for `<server>`.

When using a Unix host to run IxLoad Tcl API programs, the Windows-based host referred to in the `connect` subcommand must have the following software installed:

- The Tcl run-time environment from the IxOS installation.
- The IxLoad client component from the IxLoad client installation.

### SUBCOMMANDS

```
::IxLoad connect server (port)
```

On non-Windows client, connect to a remote IxTcl server process on `server`. `(port)` is an optional argument that forces the command to connect on a specific port number. If you do not supply a port number, the command selects a random port above 10,000. This command has no effect on Windows clients.

### **::IxLoad disconnect**

Disconnect from the last remote server used in a `connect` subcommand. This statement must be executed before exiting any IxLoad Tcl script.

### **::IxLoad level `command`**

Evaluates the `command` in the context of IxLoad. When running on a Windows system, this evaluates locally. When run on a Unix system, it is evaluated on the target system.

### **::IxLoad retrieveFile `path`**

This subcommand is intended to be used by a Unix/Linux client to retrieve files from a Windows host.

The Windows host that is the target of this subcommand is the host that the Unix/Linux client connected to in its most recent `connect` subcommand.

`retrieveFile` returns the contents of the file as a string.

### **::IxLoad retrieveFileCopy `sourcePath` `destPath`**

This subcommand is intended to be used by a Unix/Linux client to retrieve files from a Windows host. `retrieveFileCopy` copies a file from the Windows host, and creates (or overwrites) it on the Unix/Linux host.

The Windows host that is the target of this subcommand is the host that the Unix/Linux client connected to in its most recent `connect` subcommand.

`sourcePath` is the file name and path on the Windows host.

`destPath` is the file name and path on the Unix/Linux host.

### **::IxLoad retrieveResults `path`**

This subcommand is intended to be used by a Unix/Linux client to retrieve `.csv` files from a Windows host. `retrieveResults` tracks the path of the windows files internally, fetches the files, and places them in the unix machine; in the folder mentioned along with the `retrieveResults` subcommand.

The Windows host that is the target of this subcommand is the host that the Unix/Linux client connected to in its most recent `connect` subcommand.

`path` is the folder name and path on the Unix/Linux host.

```
puts "*****UnixResultDir = $UnixResultDir"
#::IxLoad retrieveResults $::IxLoadPrivate::SimpleSettings::RESULTDIR
::IxLoad retrieveResults $UnixResultDir
```



**::IxLoad sendFileCopy sourcePath destPath**

This subcommand is intended to be used by a Unix/Linux client to send files to a Windows host for use in an IxLoad test. For example, you can use this subcommand to send files such as HTTP server pages and FTP server files.

The Windows host, which is the target of this subcommand, is the host that the Unix/Linux client connected to in its most recent connect subcommand.

`sourcePath` is the file name and path on the Unix/Linux host.

`destPath` is the file name and path on the Windows host.

**OPTIONS**

None.

**EXAMPLE**

See above.

## ixChassisChain

ixChassisChain-Builds a set of Ixia chassis.

**SYNOPSIS**

```
set chassisChain [::IxLoad new ixChassisChain]
$chassisChain subcommand options...
```

**DESCRIPTION**

The `ixChassisChain` command is used to construct a chain of Ixia chassis, whose ports may be used in the `ixNetworkGroup` command for both client and server networks. Chassis are assigned chassis IDs starting at 1; these are used in the network commands to define the chassis associated with the port.

**SUBCOMMANDS**

The options for this command are configured and read using the standard `config`, `cget`, and `getOption` subcommands defined in the `ixConfig` command. In addition, the following commands are available. Unless otherwise described, no values are returned and an exception is raised for any error found.

**addChassis** *chassisName*

Adds a new chassis to the chassis chain. *chassisName* is the IP address or host name of a chassis. Each new chassis is assigned a *c*, starting at 1, which must be used to identify ports on that chassis.

**changeCardsInterfaceMode**

Changes the interface mode on CloudStorm, PerfectStorm and Lava/XM cards. To use this method, pass the hostname or IP address of the chassis, the card number that you want to change the interface mode on, and the mode. The mode can be:

CloudStorm	100G or 40G
PerfectStorm	1G, 10G, or 40G
Lava	SingleMode or DualMode
XM	100G or 3x40GMode

To change multiple cards at once, separate the card numbers separated with commas.

Example: `$chassisChain changeCardsInterfaceMode 10.20.83.90 1,2 40G`

Call this method only after the `testController` object has been created, and only on ports that are not already assigned to the test. After the card interface mode is changed, you need to add the ports to the test. If you use this method on a port in a configured test, the test configuration will be released.

**deleteChassisByName** *chassisName*

Deletes the chassis whose name is *chassisName* from the chassis chain. All other chassis IDs remain unaffected.

**getChassisNames**

Returns a list of all of the chassis names, ordered by their *chassisIDs*.

**getLoginName**

Returns the user's login name.

**isValidChassisName** *chassisName*

Checks to see whether *chassisName* is a valid IP address or host name. `True` is returned if the name is valid and `false` otherwise.

**refresh**

Refreshes all of the chassis in the chassis chain-retrieving current card and port configuration.

**refreshChassis chassisName**

Refreshes the chassis whose name is `chassisName`—retrieving current card and port configuration.

**setLoginName name**

Sets the user's login name to `name`. If this call is not made, then the name of the chassis is used when port ownership is taken.

**OPTIONS**

None.

**EXAMPLE**

```
#set chassisChain [::IxLoad new ixChassisChain]
#$chassisChain addChassis $chassisName
##### Build chassis
chain#####

set chassisChain [::IxLoad new ixChassisChain]
#$chassisChain addChassis 10.205.29.101

set client_network [::IxLoad new ixNetworkGroup $chassisChain]
$client_network config \
-comment                "" \
-name                   "client network" \
-emulatedRouterSubnetIPv6 "FFFF:FFFF:FFFF:FFFF:FFFF:FFFF::0" \
-linkLayerOptions       0 \
-ipSourcePortFrom       1024 \
-emulatedRouterGatewayIPv6 "::<" \
-cardType                "ALM1000T8-1GB" \
-emulatedRouterGateway  "0.0.0.0" \
-ipSourcePortTo         65535 \
-emulatedRouterSubnet   "255.255.255.0" \
-macMappingMode         0 \
-dnsParameters          $my_ixDns \
-tcpParameters          $my_ixTcpParameters \
-impairment              $my_ixImpairment \
-arpSettings             $my_ixArpSettings

$client_network portList.appendItem \
-chassisId 1 \
-cardId 3 \
-portId 7
```

**SEE ALSO**

`ixNetworkGroup` (see "[ixNetworkGroup](#)")

## IxChassisBuilder

chassisBuilder - Configure and manage an IxVM chassis.

### SYNOPSIS

```
set chassisBuilder [::IxLoad new ixChassisBuilder]
```

### DESCRIPTION

chassisBuilder is a a set of APIs that enable you to configure and manage an IxVM chassis.

You can use chassisBuilder to perform most of the same tasks as the IxVM Chassis Builder application, such as adding, changing, or removing cards or ports from a chassis, setting the license server, enabling or disabling promiscuous mode, setting the NTP server, etc..

### SUBCOMMANDS

The options for this command are configured and read using the standard `config`, `cget`, and `getOption`s subcommands defined in the `ixConfig` command.

### OPTIONS

#### Creating a Chassis

To create a chassis, use the following API:

```
set chassisBuilder [::IxLoad new ixChassisBuilder]
```

#### Connecting to a Chassis

To connect to a chassis, use the following API:

```
$chassisBuilder connectToChassis -chassisName "chassis name"
```

#### Changing the Chassis Settings

To change the chassis settings, you first need to issue a `get` command.

```
set chassisSettings [$chassisBuilder getChassisSettings]
```

The `chassisSettings` objects has 4 parameters which can be inspected

- `LicenseServer`
- `EnableLicenseCheck`
- `NtpServer`
- `TxDelay`

To get a parameter, use the `cget` method. For example: `[$chassisSettings cget -NtpServer]`

You can change the value of a specific parameter by issuing a `cset`. For example: `[$chassisSettings cset -NtpServer 10.215.10.99]`

When you have finished changing the settings, to make them permanent, you will need to do the following:

```
[$chassisBuilder setChassisSettings -chassisSettings $chassisSettings]
```

### Adding a Card

To add a card, use the following API:

```
[$chassisBuilder addCard -managementIp "127.0.0.1" -cardServerId 2 -keep-AliveTimeout 100]
```

### Clearing Ownership

To clear ownership, use the following API:

```
[$chassisBuilder clearOwnership -cardId cardid]
```

### Adding a Port

To add a port to a specific card ID, use the following API:

```
[$chassisBuilder addPort -cardId 2 -portId 1 -interfaceName "eth0" -promiscMode true/false -mtu 5000 -lineSpeed "1000"]
```

### Adding and Removing Credentials

To remove credentials for a specific server, use the following API:

```
[$chassisBuilder removeCredentials -serverName "10.215.10.99"]
```

To add a specific credential set, use the following API:

```
[$chassisBuilder addCredentials -serverName "10.215.10.99" -enable true -user user1 -password password1 -applianceType "Qemu"]
```

`applianceType` is the VM type, and can be one of the following:

- "N/A"
- "Qemu"
- "VMWare"

### Connecting a Card

To connect a disconnected card, use the following API:

```
[$chassisBuilder connectCard - cardId 1]
```

### Deleting a Card

To delete a card, use the following API:

```
[$chassisBuilder deleteCard -cardId 1]
```

### Disconnecting a Card

To disconnect a card, use the following API:

```
[$chassisBuilder disconnectCard -cardId 1]
```

### Getting Card Info

To get the card Information by card ID, use the following API:

```
set card [$chassisBuilder getCardById -cardId 3]
```

The card object has the following properties which can only be retrieved (using `cget`):

- CardName
- CardServerId
- KeepAliveTimeout
- ManagementIp
- Status

### Getting a List of Ports

To get a list of all ports of a specific card, the user should use the following API.

```
set portList [$chassisBuilder getCardPorts -cardId 1]
```

`portList` is a list of `portInfo` objects. Each `portInfo` object has the following properties, which can only be retrieved (using `cget`):

- InterfaceName
- MTU
- PortName
- PortServerId
- PromiscMode
- Status

### Getting the Chassis Topology

To get a list of the chassis topologies, use the following API:

```
set topologies [$chassisBuilder getChassisTopology]
```

`topologies` is a list of `ixTopology` objects. Each object has the following properties, which can only be retrieved (using `cget`):

- CardServerId
- InterfaceName
- IPAddress
- KeepAliveTimeout
- LineSpeed

- MAC
- MTU
- PortServerId
- PromiscMode

### Getting Credentials

To get a list of discovered credentials, use the following API:

```
set credentials [$chassisBuilder getDiscoveredCredentials]
```

`credentials` is a list of `ixServerInfo` objects. Each object has the following properties, which can only be retrieved (using `cget`):

- Enabled
- ErrorMessage
- HasError
- ServerName
- ServerPassword
- ServerType
- ServerUser

### Getting a Card ID

To get a card ID based on a management IP, use the following API:

```
set cardId [$chassisBuilder getIxVMCardByIP -managementIp "10.215.10.100"]
```

### Rebooting a Chassis

To perform a hard reboot of a chassis, use the following API:

```
[$chassisBuilder hardChassisReboot]
```

### Loading Topology from a File

To load a topology from a csv file, use the following API:

```
[$chassisBuilder loadTopologyFromCsv -path "path to the file"]
```

### Rebuilding the Topology

To rebuild the chassis topology, use the following API:

```
[$chassisBuilder rebuildChassisTopology -usePreviousSlotId true -promiscMode true appVersion ""]
```

### Rediscovering Appliances

To rediscover the appliances, use the following API:

```
[$chassisBuilder rediscoverAppliances]
```

## Removing a Port

To remove a port by id, use the following API:

```
[$chassisBuilder removePortById -cardId 1 -portId 2]
```

## Updating a Card

To update a card by ID, use the following API:

```
[$chassisBuilder updateCard -cardServerId -managementIp="10.215.11.11" -keep-AliveTimeout true]
```

## Updating a Port

To update a port by id, use the following API:

```
[$chassisBuilder updatePortById -cardId 1 -portId 1 promiscMode false mtu 1000 lineSpeed "5000"]
```

## Getting a List of Virtual Machines

To get a list of discovered machines, use the following API:

```
set machines [$chassisBuilder getDiscoveredMachines]
```

`machines` is a list of `ixDiscoveredMachine` objects. Each object has the following properties, which can only be retrieved (using `cget`):

- `ApplianceName`
- `Interfaces`, which is a list of `ixDiscoveredInterface` objects. Each object has the following properties:
  - `InterfaceName`
  - `State`, which can have one of the following values:
    - "Available"
    - "Assigned"
    - "Unusable"
  - `InterfaceNumber`
  - `ManagementIp`
  - `Type`, which can have one of the following values:
    - "N/A"
    - "Qemu"
    - "VMWare"

## Rebooting Cards

To reboot specific cards by their ID, use the following API:

```
[$chassisBuilder hwRebootCardByIDs -cardIDs "a list of card ids"]
```



**EXAMPLE**

```

package require IxLoad

::IxLoad connect 1.2.3.4
set logtag "IxLoad-api"
set logName "simplehttp"
set logger [::IxLoad new ixLogger $logtag 1]
set logEngine [$logger getEngine]
$logEngine setLevels $::ixLogger(kLevelDebug) $::ixLogger(kLevelInfo)
$logEngine setFile $logName 2 256 1

#Create a new chassis builder
set chassisBuilder [::IxLoad new ixChassisBuilder]

# connect to a chassis
$chassisBuilder connectToChassis -chassisName "10.215.122.90"

#getting a chassis topology and showing properties
set topologies [$chassisBuilder getChassisTopology ]
set count [$topologies indexCount]
set index 0
set topology [$topologies getItem 0]
set CardServerId [$topology cget -CardServerId]
set InterfaceName [$topology cget -InterfaceName]
set IPAddress [$topology cget -IPAddress]
set KeepAliveTimeout [$topology cget -KeepAliveTimeout]
set LineSpeed [$topology cget -LineSpeed]
set MAC [$topology cget -MAC]
set MTU [$topology cget -MTU]
set PortServerId [$topology cget -PortServerId]
set PromiscMode [$topology cget -PromiscMode]

#add a card and a port example
set cardIp "10.215.122.96"
$chassisBuilder addCard -managementIp $cardIp -keepAliveTimeout 300
set cardId [$chassisBuilder getIxVMCardByIP $cardIp]
$chassisBuilder addPort -cardId $cardId -portId 1 -interfaceName "eth1" -promis-
cMode False -lineSpeed "1000"

#changing the license server on a virtual chassis
$chassisSettings cset -LicenseServer "10.215.122.90"
$chassisBuilder setChassisSettings $chassisSettings

#get cardId and connect it to the chassis
set cardId [$chassisBuilder getIxVMCardByIP $cardIp]
$chassisBuilder connectCard -cardId $cardId

#disconnecting a card
$chassisBuilder disconnectCard -cardId $cardId

#getting discovered machines
puts "Getting discovered machines"

```

```
set machines [$chassisBuilder getDiscoveredMachines]
set count [$machines indexCount]
if { $count == 0} {
puts "No machines discovered ! Should do a rediscovery !"
} else {
set index 0
puts $count
puts "There are $count machines discovered"
set machineInfo [$machines getItem 0]
set ApplianceName [$machineInfo cget -ApplianceName]
set Interfaces [$machineInfo cget -Interfaces]
set ManagementIp [$machineInfo cget -ManagementIp]
set Type [$machineInfo cget -Type]
set InterfaceNumber [$machineInfo cget -InterfaceNumber]
::IxLoad disconnect
```

## ixCustomPortMap

ixCustomPortMap-Customizes the order and frequency, by which client IPs will access server IPs.

### SYNOPSIS

```
$destination1 config -portMapPolicy $ixPortMap(kPortMapCustom)
```

```
set customPortMap [$destination1 cget customPortMap]
```

```
$customPortMap subcommand options
```

### DESCRIPTION

The `ixCustomPortMap` command is used to map a range of client and server traffic is used to map client IPs onto server IPs or client VLANs onto server VLANs.

A custom port map is associated with a specific symbolic destination.

To create a Custom traffic map, the client and server network ranges, `rangeType` parameter can be anything, except IPsec. For DHCP and PPPoE ranges, VLAN must be enabled on both the client and server networks to use a custom traffic map.

### SUBCOMMANDS

None.

### OPTIONS

```
submapsIPv4
```

This is an `ixConfigSequenceContainer` holding a list of `Submap` objects.

```
submapsIPv6
```

This is an `ixConfigSequenceContainer` holding a list of `Submap` objects.

## Steps for Custom Traffic Mapping

To setup a Custom Traffic Map:

1. Set up the custom Traffic Map for symbolic destination. After creating the test object and assigning traffic-network mappings, setup the custom traffic map for the symbolic destination.

```
set destination1 [$clnt_t_n_mapping getDestinationForActivity my_http_client svr_
traffic_my_http_server]
```

2. Set up the client or server traffic-network mapping. Set the client or server traffic-network mapping for a custom traffic. Set the `port` for a destination to `kPortMapCustom`. Now it is possible to access the `customPortMap` property on the destination object.

```
$destination1 config -portMapPolicy $ixPortMap(kPortMapCustom)
```

3. Include the custom port map object. This includes the custom port map object into a local variable for convenience of scripting.

```
set customMap [$destination1 cget -customPortMap]
```

4. Set the submaps. A submap is a portion of a `customPortMap` that describes a simple relationship between a set of source addresses and a set of destination addresses. Complex relationships can be described using multiple `ixPort` objects.

```
set submap [$customMap submapsIPv4.getItem 0]
```

5. Set the submap's mesh type to be IP range pairs:

```
$submap config -meshType $ixSubmap(kMeshTypeIpRangePairs)
```

IP mesh types start out with `ixSubmapRange` objects that correspond to network ranges in the client and server networks for the symbolic destination. In this mode, `ixSubmapRange` IDs are the row numbers of the corresponding ranges in the networks. `ixSubmapRange` can be split into smaller, equal sub-ranges using the `split` command. Refer to `Split` and `Merge Submaps`.

VLAN mesh types start out with `ixSubmapRange` objects that correspond to VLAN IDs (one `ixSubmapRange` per VLAN) in the client and server networks for the symbolic destination. In this mode, `ixSubmapRange` IDs are the same as the VLAN IDs they represent. Each `ixSubmapRange` can potentially span portions of many network ranges, depending on how the VLANs are specified on those ranges.

6. Specify the interconnections. You can now specify which server submap range that each client submap range communicates with. In the following example, the numbers next to the source range and the destination range show the mapping pattern.

```
# wire second source range to first destination range# and vice versa
$submap
sourceRanges(0).config -destinationId 3$submap sourceRanges(1).config -destinationId
1$submap sourceRanges(2).config -destinationId 1$submap sourceRanges(3).config -
enable 0
```

7. Split and merge submaps. For IP meshes, you can split a range in the list into subranges by calling the `split` method on that range. Once split, a range can be merged by calling `merge` on it. `Merge` doesn't need a parameter because it removes all of the child nodes originally created by using the `split`.

```
# split some ranges
$submap sourceRanges(0).split 2$submap destinationRanges(0).split
```

2

**EXAMPLE**

```
#-----# Set up the custom
traffic map for the symbolic destination.# This must be done after creating the test
object and assigning# traffic-network mappings#-----
-----

set destination1 [$clnt_t_n_mapping getDestinationForActivity my_http_client svr_
traffic_my_http_server]$destination1 config -portMapPolicy $ixPortMap(kPortMapCus-
tom)

# setting custom port map creates and initializes the custom port map object# get it
so we can modify it

set customMap [$destination1 cget -customPortMap]

# the default has a single submap range available. Modify itset submap [$customMap
submapsIPV4.getItem 0]

# set it to an IP range pair type$submap config -meshType $ixSubmap
(kMeshTypeIpRangePairs)# split some ranges#$submap sourceRanges(0).split 2#$submap
destinationRanges(0).split 2# wire second source child to first destination child#
and vise versa

$submap sourceRanges(0).config -destinationId 3$submap sourceRanges(1).config -des-
tinationId 1$submap sourceRanges(2).config -destinationId 1$submap sourceRanges(3).-
config -enable 0
```

**SEE ALSO**

[ixClientTrafficNetworkMapping](#)

## ixPlaylists

ixPlaylist - Configure a playlist.

**SYNOPSIS**

```
set Playlist1 [::IxLoad new ixPlaylist]
$Playlist1 config \
```

## DESCRIPTION

`ixPlaylist` configures a playlist, a list of files to played.

A playlist is added to the activity in a `ixNetTraffic` object using `appendItem` subcommand. To configure the playlist, use the `config` subcommand.

Only certain protocols support playlists. Ensure that the protocol in the activity you are adding the playlist to supports playlists.

## SUBCOMMANDS

The options for this command are configured and read using the standard `config`, `cget`, and `getOptions` subcommands defined in the `ixConfig` command. In addition the following commands are available. Unless otherwise described, no values are returned and an exception is raised for any error found.

## OPTIONS

`splitMethod`

Determines how the playlist is distributed among the ports in the test.

Value	Description
<code>sameFileOnEachPort</code>	(Default) The entire playlist is duplicated on each port
<code>splitFileAcrossPorts</code>	The playlist is divided equally among the ports.
<code>splitFileAcrossPortsAsFixedSlices</code>	The playlist is divided into chunks containing the number of entries you specify, and distributes one chunk to each port. Specify the number of entries in the <code>entryCountOnEachPort</code> parameter.

`name`

Name of the playlist.

Default = "Playlist $n$ " where  $n$  is a sequential integer starting with 1.

`filename`

Name of the CSV file to use as the source of the playlist data.

Default = "" (None)

`indexIncrementMethod`

If `userSequencing` is set to `sequential` or `uniqueOffset`, this option determines the order that entries are loaded from the playlist.

Value	Description
-------	-------------

perIteration	(Default) All commands access the same resource in the playlist.
perCommand	Each command access a different resource in the playlist, in order.

poolType

Entry in the playlist each user begins executing with.

Value	Description
specificPool	(Default) Defines a fixed, repeatable pattern for distributing the playlist resources among the users. If you select this option, you must specify values for the <code>userSequencing</code> and <code>indexIncrementMethod</code> parameters.
globalPool	The playlist is accessed in order, without regard to which user accesses a particular entry.

entryCountOnEachPort

If `splitMethod` is `splitFileAcrossPortsAsFixedSlices`, this parameter determines the number of entries for each port.

Default = 1

userSequencing

Method used to initially distribute the resources among the users. See the description in the User Guide for a full description of the parameters.

Value	Description
sequential	(Default) Users access resources based on their order in the playlist.
uniqueOffset	Users access resources based on their user ID.
randomOffset	Users access resources randomly.

firstRowIsColumnHeader

If true, the entries in the first row of each column are used as headings for each column. If false, default entries are used for column headings.

Values = true (default), false

## EXAMPLE

```
$Activity_IPTV_VideoClient1 playlists.clear
```

```

set Playlist1 [::IxLoad new ixPlaylist]
$Playlist1 config \
-splitMethod          "sameFileOnEachPort" \
-name                 "Playlist1" \
-filename             "C:\\Users\\user1\\Desktop\\playlist.csv" \
-indexIncrementMethod "perIteration" \
-poolType             "specificPool" \
-entryCountOnEachPort 1 \
-userSequencing       "sequential" \
-firstRowIsColumnHeader true

$Activity_IPTV_VideoClient1 playlists.appendItem -object $Playlist1

```

[...]

```

$Activity_IPTV_VideoClient1 agent.pm.commands.appendItem \
-commandType         "PlayMediaCommand" \
-media               "\{\{\{playlist.Playlist1.\$Media\}\}\}" \
-symServerIP         "\{\{\{playlist.Playlist1.\$Site\}\}\}" \
-cmdName             "Play Media 1"

```

## ixPort

ixPort - retrieves the ID of an Ixia port and controls the port capture.

### SYNOPSIS

```

$network portList.appendItem -chassisId 1 -cardId 1 - portId 1
set port [$network portList.getItem 0]

```

## DESCRIPTION

The `ixPort` command is used to define and retrieve the attributes of an Ixia port that is a member of a `portList` object. For example:

```
puts "Added card [$clnt_network portList(0).getId]"
```

## SUB-COMMANDS

None.

## OPTIONS

`getId`

Returns a string indicating the chassis ID, card ID, and port ID of a port, in the following format:

```
chassisID.cardID.portID
```

`getOwner`

Returns a string indicating the current owner of the port. Returns an empty string if there is no owner.

`isLinkUp`

Returns a flag indicating, whether a cable is connected to another live port.

`isPortCaptureEnabled`

This returns a flag indicating the capture is enabled on the port.

`setPortCaptureEnable`

This enables the port capture. It is also enabled during the traffic-network map

`setPortCaptureFileName`

This enables the port capture and saves the details in a file on the hard disk.

## EXAMPLE

```
#-----# Build Chassis Chain
and add a Chassis#-----

set chassisChain [::IxLoad new ixChassisChain]$chassisChain addChassis myChassis#---
-----# Build client Network#---
-----

set clnt_network [::IxLoad new ixClientNetwork $chassisChain]#-----
-----# Add a port#-----
-----

$clnt_network portList.appendItem \-chassisId 1 \-cardId 1\ -portId 1#-----
```



```
-----# Get the port back and
check its ID#-----
```

```
puts [$clnt_network portList(0).getId]
```

## SEE ALSO

[ixChassisChain](#)

## ixSubmap

### SYNOPSIS

```
set submap [$customMap submapsIPv4.getItem 0]
$submap config -meshType $ixSubmap(kMeshTypeIpRangePairs)
```

### DESCRIPTION

A portion of a `customportmap` that describes a relationship between a set of source addresses and destination addresses. Arbitrarily complex relationships can be described using multiple `ixSubmaps`.

### Options

`name`

This is the user-defined name for the submap.

`destinationRanges`

List of `ixSubmapRange` objects representing the server IPs.

`sourceRanges`

List of `ixSubmapRange` objects representing the server IPs.

`ipType`

IP version (IPv4 or IPv6) used on the submap (read-only).

`allowsIpMesh`

Returns 1 if IP `meshTypes` are allowed (read-only).

`allowsVlanMesh`

Returns 1 if the VLAN `meshTypes` are allowed (read-only).

`meshType`

This defines the relationship between the `sourceRanges` and `destinationRanges`. Can be one of:

Option	Usage
<code>::ixSubmap</code> ( <code>kMeshor</code> "ipRangeMesh")	A pattern based on IP addresses, where each enabled client range communicates to all enabled server ranges.
<code>::ixSubmap</code> ( <code>kMeshor</code> "ipRangePairs")	A pattern based on IP addresses, where each enabled client range communicates with a single server range, as specified by the client range's <code>destinationId</code> option (see <code>ixSubmapRange</code> command).
<code>::ixSubmap</code> ( <code>kMeshTypeVlanor</code> "vlanRange")	A pattern based on VLAN IDs, where each enabled client range communicates with all enabled server ranges.
<code>::ixSubmap</code> ( <code>kMeshTypeVlanor</code> "vlanRange")	A pattern based on VLAN IDs, where each enabled client range communicates with all enabled server ranges.

## ixSubmapRange

### DESCRIPTION

A group of IPs, specified by either VLAN or IP (as determined by the `ixSubmap meshType` option). A submap range is the smallest unit of client or server IPs for specifying the traffic flow between clients and servers.

### OPTION

`id`

This is the IxLoad-assigned ID for the submap. This is read-only.

`enable`

This enables or disables traffic for the submap range. In full mesh modes, `enable` applies to both the client and server submap ranges. In range pair modes, `enable` affects the submap ranges only. All enabled client submap ranges will talk to their specified destination submap range, whether enabled or not.

destinationId

This is enabled for client submap ranges in a range pair meshType mode. It specifies the destination submap range to be communicated with. It can handle a list of destination IDs

childRanges

This is for IP meshTypes only. This is an `ixConfigSequenceContainer` with a list of `ixSubmapRanges` for nodes created via the `split` command. This list cannot be extended manually via `appendItem`.

## ixIntRange

### DESCRIPTION

This holds the items of comma separated list of ports defined in `portRanges` of `ixDutProtocolPortRange`. These items can either be a single integer value or a range of integers.

```
set my_ixIntRange [::IxLoad new ixIntRange]
$my_ixIntRange config \
-intRange "16-80"
```

### OPTION

intRange

The value of `portRanges` of `ixDutProtocolPortRange`.

### EXAMPLE

```
set destination [$Traffic1_Network1 getDestinationForActivity "HTTPClient1" "DUT1:-
custom"]$destination config \-portMapPolicy "customMesh"
```

```
$destination portRangeList.clear
```

```
set my_ixIntRange [::IxLoad new ixIntRange]$my_ixIntRange config \-intRange
"16"
```

```
$destination portRangeList.appendItem -object $my_ixIntRange
```

```
set my_ixIntRange1 [::IxLoad new ixIntRange]$my_ixIntRange1 config \-intRange
"18"
```

```
$destination portRangeList.appendItem -object $my_ixIntRange1
```

```
set my_ixCustomPortMap [$destination cget -customPortMap]
```

```
set Submap1 [$my_ixCustomPortMap submapsIPv6.getItem 0]$Submap1 config \-name  
"Submap1" \-meshType "ipRangeMesh"
```

## ixRepository

ixRepository-Creates a repository object (RXF file).

### SYNOPSIS

```
set ::repository [::IxLoad new ixRepository -name path]
```

### DESCRIPTION

The repository (.RXF file) object is a set of lists that represents the tree shown in the IxLoad GUI. There are six lists, one for each top-level node in the GUI tree: clientNetworkList, serverNetworkList, dutList, clientTrafficList, serverTraffiand testList.

In order to create a repository, all test components (networks, traffic, activities, traffic-network mappings, and tests) to be saved in a repository must be created in these lists.

Similarly, the contents of an existing repository can be manipulated by manipulating the objects in these lists. The lists are of type `ixConfigSortedNamedItemList`.

For examples of repository usage, see the following scripts in the \Samples directory.

- `reprun.tcl` - Runs all tests in a repository.
- `repNewHTTP.tcl` - Creates a new repository.
- `reprunhttpstats.tcl` - Runs all tests in a repository and collects http stats.

### SUBCOMMANDS

The options for this command are configured and read using the subcommands defined in the `ixConfigSortedNamedItemList` command.

### OPTIONS

`name`

Specifies the path to the file.

`activeTest`

The name of the active test in the repository. This test should be selected when the repository is loaded into the IxLoad GUI.

`clientNetworkList`

List of the client networks in the repository. This is a list of type `ixConfigSortedNamedItemList`.

`serverNetworkList`

List of the server networks in the repository. This is a list of type `ixConfigSortedNamedItemList`.

`dutList`

List of the DUTs in the repository. This is a list of type `ixConfigSortedNamedItemList`.

`clientTrafficList`

List of the client activities in the repository. This is a list of type `ixConfigSortedNamedItemList`.

`serverTrafficList`

List of the server activities in the repository. This is a list of type `ixConfigSortedNamedItemList`.

`testList`

List of the test configurations (traffic-network mappings, timelines, port selections in the repository. This is a list of type `ixConfigSortedNamedItemList`.

`write`

Save the repository to a file. `-write` takes the following arguments:

<code>-destination</code>	The path to the file. Can be omitted to rewrite an existing repository opened with the <code>-name</code> option.
<code>-overwrite</code>	If <code>true</code> , overwrites an existing file, provided it is accessible and not write-protected. (Defaults = <code>false</code> ).

### EXAMPLE

```
#Create an empty repository and save itset ::newRepository [::IxLoad new ixRe-
pository ]$:::newRepository write -destination newRepository -overwrite 1
```

### SEE ALSO

## ixSendEventCommand

`ixSendEventCommand` - trigger a waiting command

### SYNOPSIS

```
$my_ixSendEventCommand config \
```

*-optionvalue*

## DESCRIPTION

`ixSendEventCommand` and `ixWaitEventCommand` synchronize the command lists of two or more activities within a Subscriber NetTraffic. `ixWaitEventCommand` stops command list execution until an `ixSendEventCommand` with a matching `eventId` is called. `ixSendEventCommand` causes all command lists within a Subscriber NetTraffic that are currently stopped by an `ixWaitEventCommand` with a matching `eventId` to resume execution.

`ixSendEventCommand` and `ixWaitEventCommand` are added to an `actionList` using the `appendItem` command.

For example, if `Command2` must be executed only after `Command1` has been executed:

1. An `ixWaitEventCommand` is inserted preceding `Command2`.
2. A `ixSendEventCommand` is added after `Command1`, with the same `eventID` as in the `ixWaitEventCommand`.

When `Command1` finishes executing, the `ixSendEventCommand` ends the `ixWaitEventCommand` for `Command2`, causing `Command2` to be executed.

`ixSendEventCommand` and `ixWaitEventCommand` can only be used with Subscriber activities.

## OPTIONS

`commandType`

Command type. The only value is "SendEventCommand".

`eventID`

ID of the corresponding `ixWaitEventCommand`. Default value = 1.

## EXAMPLE

```
set my_ixSendEventCommand [::IxLoad new ixSendEventCommand]
$my_ixSendEventCommand config \
-commandType"SendEventCommand" \
-eventId1

$Subscriber_Activity_HTTPClient1 agent.actionList.appendItem -object $my_ixSendEventCommand
.
.
.
```

```
$Subscriber_Activity_FTPClient1 agent.actionList.clear
```

```
set my_ixWaitEventCommand [::IxLoad new ixWaitEventCommand]
```

```
$my_ixWaitEventCommand config \  
-commandType"WaitEventCommand" \  
-eventId1
```

```
$Subscriber_Activity_FTPClient1 agent.actionList.appendItem -object $my_ixWaitEventCommand
```

## SEE ALSO

[ixWaitEventCommand](#)

## ixStatCatalogItem

ixStatCatalogItem-Describes a single item in a stat catalog.

### SYNOPSIS

```
set statCatalog [$ixTestObject getStatCatalog]puts [[lindex $statCatalog 0]  
statSpecList(0).cget -name]
```

### DESCRIPTION

The `ixStatCatalogItem` object is a returned element of a list from the `ixTest g` command. It describes a statistics source and all of the statistics and filters available from that source.

### SUBCOMMANDS

The options for this command are read using the standard `cget` and `getOptions` subcommands defined in the `ixConfig` command.

### OPTIONS

`statFilterList`

(Read Only). The list of all filters available from the agent. Each item of the list is of type `ixStatFilter`. Refer to `ixConfigSequenceContainer` for a list of commands that may be used to manipulate this list.

`statSourceType`

(Read Only). The agent from which statistics originate, of the form:  
Protocol Client/Server

Where `Protocol` is one of the supported protocols—for example, HTTP or FTP, and `Client/Server` is one of those two values. Some examples are:  
"HTTP Client""FTP Server"

`statSpecList`

(Read Only). The list of all statistics available from the agent. Each item of the list is of type `ixStatSpec`. Refer to `ixConfigSequenceContainer` for a list of commands that may be used to manipulate this list.

### EXAMPLE

```
puts [[lindex $statCatalog 0] statSpecList(0).cget -name]
```

### SEE ALSO

[ixTest](#)

[ixStatFilter](#)

[ixStatSpec](#)

## ixStatFilter

`ixStatFilter`—Describes a single statistics filter in a stat catalog.

### SYNOPSIS

```
set statCatalog [$ixTestObject getStatCatalog]  
puts [[lindex $statCatalog 0] statFilterList(0).cget -type]
```

### DESCRIPTION

The `ixStatFilter` object is one element of the `statFilterList` option of the `ixStatCatalogItem` object. It describes a single filter available for a protocol agent (`statSourceType`).

### SUBCOMMANDS

The options for this command are read using the standard `cget` and `getOptions` subcommands defined in the `ixConfig` command.

### OPTIONS

`type`

(Read Only). The type of the filter available. One of:



Option	Usage
<code>\$.:ixStatFilter(kTypePort)</code> or "Port"	A filter operation may be performed across the port described in the <code>value</code> field.
<code>\$.:ixStatFilter(kTypeCard)</code> or "Card"	A filter operation may be performed across the card described in the <code>value</code> field.
<code>\$.:ixStatFilter(kTypeChassis)</code> or "Chassis"	A filter operation may be performed across the chassis described in the <code>value</code> field.
<code>\$.:ixStatFilter(kTypeActivity)</code> or "Activity"	A filter operation may be performed across the activity described in the <code>value</code> field.
<code>\$.:ixStatFilter(kTypeCommunity)</code> or "Traffic-NetworkMapping"	A filter operation may be performed across the community described in the <code>value</code> field.

`value`

(Read Only). A value corresponding to the value of the `type` option. One of:

Option	Usage
<code>\$.:ixStatFilter(kTypePort)</code> or "Port"	A port specification in the form: <code>chassis/card/port</code>
<code>\$.:ixStatFilter(kTypeCard)</code> or "Card"	A port specification in the form: <code>chassis/card</code>
<code>\$.:ixStatFilter(kTypeChassis)</code> or "Chassis"	A port specification in the form: <code>chassis</code>
<code>\$.:ixStatFilter(kTypeActivity)</code> or "Activity"	The name associated with an <code>ixCustomPortMap</code> or <code>ixServerTraffic</code> object in the test.

<code>::ixStatFilter</code> ( <code>kTypeCommunity</code> ) or "Traffic-Net- workMapping"	The name associated with an <code>ixClientTrafficNetworkMapping</code> or <code>ixServerTrafficNetworkMapping</code> object in the test.
--	--

**EXAMPLE**

```
puts [[lindex $statCatalog 0] statFilterList(0).cget -type]
```

**SEE ALSO**

[ixTest](#)

[ixStatCatalogItem](#)

## ixStatSpec

`ixStatSpec`-Describes a single statistic in a stat catalog.

**SYNOPSIS**

```
set statCatalog [$ixTestObject getStatCatalog]  
puts [[lindex $statCatalog 0] statSpecList(0).cget -type]
```

**DESCRIPTION**

The `ixStatSpec` object is one element of the `statSpecList` option of the `ixStatCatalogItem` object. It describes a single statistic available for a protocol agent (`statSourceType`).

**SUBCOMMANDS**

The options for this command are read using the standard `cget` and `getOptions` subcommands defined in the `ixConfig` command.

**OPTIONS**

`aggregationFunctionCode`

(Read Only) . The type of statistic which this represents. One of:

Option	Usage
"Raw"	

"Interpolated"	
"Interpolated Rate"	
"Rate"	
"Smooth"	
"Interval Maximum"	
"Interval Minimum"	
"Interval Average"	
"Interval Weighted Average"	
"Sum over ports"	
"Maximum over ports"	
"Minimum over ports"	
"Average over ports"	
"Weighted Average over ports"	

`enablePortAggregation`

(Read Only). If `true`, then it is possible to aggregate this statistic for all agents on a port.

`name`

(Read Only). The name of the statistic. This is the same name that is used in the `name` field of the `::statCollectorUtils::AddStat -statName` argument.

`path`

(Read Only). The internal full-path name of the statistic.

### EXAMPLE

```
puts [[lindex $statCatalog 0] statSpecList(0).cget -type]
```

### SEE ALSO

[ixTest](#)

[ixStatCatalogItem](#)

## ixTest

ixTest-Builds a complete IxLoad test.

### SYNOPSIS

```
set Test1 [::IxLoad new ixTest]
```

```
$test subcommand options...
```

### DESCRIPTION

The `ixTest` command is used to construct a complete IxLoad test structure. It consists of a list of client traffic-network and server traffic-network mappings, called communities. In addition to the two lists, several options control global operation. An `ixTest` command is used in conjunction with a `ixTestController` to operate the test and collect statistics.

### SUBCOMMANDS

The options for this command are configured and read using the standard `config`, `cget`, and `getOption` subcommands defined in the `ixConfig` command. In addition, the following commands are available. Unless otherwise described, no values are returned and an exception is raised for any error found.

#### getStatCatalog

This subcommand returns a list of objects of type `ixStatCatalogItem` that define all of the statistics available, along with all possible filters. Refer to `ixConfigSequenceContainer` for a list of commands that may be used to manipulate this list.

#### getCommunityList

This subcommand returns all the communities in the test in no particular order. It is provided for convenience. It is essentially equivalent to getting the `clientCommand` `serverCommunityList` and concatenating them.

```
# set the chassis chain on the repository
# since there is no chassisChain clear,
# it's easiest to start with a new one

myChassisChain = new ixChassisChain
myChassisChain.addChassis("myChassis")
repository.chassisChain = myChassisChain

# set ports on all the networks in the tests
# for test in repository.testList:
# or pick a specific test

for community in test.getCommunityList():
community.network.portList.clear()
```

```
# update x & y with next card and port to assign
# (assuming single chassis)
community.network.portList.appendItem(chassisId = 1, \ cardId = x, portId = y)
```

For an example of how to load a repository, see `RepRun.tcl` in the `Samples` directory.

## OPTIONS

`clientCommunityList`

A list of objects of type `ixClientTrafficNetworkMapping` that define the client agent to network mappings used to generate client traffic. Refer to `ixConfigSequenceContainer` for a list of commands that may be used to manipulate this list. (Default = {}).

`comment`

A comment associated with the test. (Default = "").

`csvInterval`

The interval, in seconds, at which the CSV statistics files are updated. In the GUI, this parameter is on the Test Options pane and is labeled `CSV Polling Interval`. This parameter does not set the statistics callback interval, which you must define manually for each script (see `statCollectorUtils` on page 4-60). (Default = 4).

`enableForceOwnership`

If `true`, at the beginning of the test, any ports that are selected for the test but owned by another user are rebooted and their previous ownership cleared. This parameter corresponds to the GUI option "Forcefully Take Ownership." (Default = `false`).

`enableReleaseConfigAfterRun`

If `true`, purges the test configuration from the ports after a test completes, releases ownership of them, and the ports will no longer respond to ARPs and PINGs from the DUT. (Default = `false`).

`enableResetPorts`

If `true`, IxLoad reboots the ports before downloading the test configuration to them. To ensure the integrity of your testing, it is always safest to reboot the ports before running a test. However, rebooting the ports does increase the amount of time required to prepare the ports for a test.

If you are developing a test and making incremental changes to it and then run it to see the effect of your changes, it may be safe to save time by not rebooting the ports before each run.

If you do not want to reboot the ports for every test, you should at least reboot the ports the first time you load a repository; this will ensure that any software structures remaining from a previous test or other application are properly removed. (Default = `false`).

`name`

The name associated with this object. (Default = "TestEnvelope").

`serverCommunityList`

A list of objects of type `ixServerTrafficNetworkMapping` that define the server agent to network mappings used to simulate network servers. Refer to `ixConfigSequenceContainer` for a list of commands that may be used to manipulate this list. (Default = {}).

`statsRequired`

If `true`, statistics will be collected for the test. (Default = 1).

### EXAMPLE

```
#-----# Create the test#-----
-----set Test1 [::IxLoad new
ixTest]$Test1 config \-comment          "" \-csvInterval
4 \-name                                "Test1" \-statsRequired
1 \-enableResetPorts                    0 \-enableForceOwnership
false \-enableReleaseConfigAfterRun     0 \-captureViewOptions
$my_ixViewOptions

$Test1 scenarioList.clear

$Test1 scenarioList.appendItem -object $TrafficFlow1
```

### SEE ALSO

[ixTestController](#)

[ixDut](#)

## ixTestController

`ixTestController`-Controls execution of an IxLoad test.

### SYNOPSIS

```
set testController [::IxLoad new ixTestController options]
```

```
$testController subcommand options...
```

### DESCRIPTION

The `ixTestController` command is used to control the execution of an IxLoad test. The `ixTest` object is referenced in this command's `run` subcommand.

### SUBCOMMANDS

The options for this command are configured and read using the standard `config`, `cget`, and `getOption` subcommands defined in the `ixConfig` command. In addition, the following commands are avail-

able. Unless otherwise described, no values are returned and an exception is raised for any error found.

## OPTIONS

### **addReportFile**

Adds a file to the IxReporter test results folder. This option corresponds to adding files to the Files tab in IxReporter. You can add the following types of files: BMP, JPG, CSV, PNG, GIF. For example: "c:/temp/reportFiles/http.csv" or "c:/temp/images/http.bmp". If you add a CSV file, you must add the metadata file in the same folder as well. You can call this API after the test is stopped. See `generateReport` for more information.

Values: Full path and name of file to add. Default = "" (none).

### **addReportFilesFromFolder**

Adds all the files in a folder to the IxReporter test results folder. This option corresponds to adding files to the Files tab in IxReporter. You can add the following types of files: BMP, JPG, CSV, PNG, GIF. For example: "c:/temp/reportFiles". If you add a CSV file, you must add the metadata file in the same folder as well. You can call this API after the test is stopped. See `generateReport` for more information.

Values: Full path of the folder to add. Default = "" (none).

### **applyConfig**

Downloads the test configuration to the Ixia ports. The syntax is the same as for the `run` subcommand.

### **applyObjectiveValues**

Applies the new objective values that are configured on the activity when the test is running. See the example for `canSetObjectiveValue`.

### **autorepository**

Automatically creates a repository that is used as the source of data for the "Test Configuration" section in a generated report. The repository is created in the results (`$resultDir`) directory.

The `autorepository` and `repository` subcommands can both be used to create repositories that are the source of data for the "Test Configuration" section of reports.

- `autorepository` creates a repository based on IxLoad's internal, ephemeral repository.
- `repository` creates a copy of the repository specified by `$repository` (created using `ixRepository`).

The choice of which one to use depends on whether or not you are using an `$repository` object in your test:

- If you are using `$repository`, use `repository`.
- If you are not using `$repository`, use `autorepository`.

`autorepository` requires the repository file name as an argument.

For example, the following generates a repository named `My_Rep.rxf`:  
`$testController run $test -autorepository "My_Rep.rxf"`

### **canSetObjectiveValue**

Checks whether the objective value can be set on the activity when the test is running. The objective value can be changed only during the Ramp-up and Sustain phases of the test.

For a result equivalent to changing the objective values in the GUI ("modify-on-the-fly"), make sure your script changes the `objectiveValue`, not the `userObjectiveValue`. Your script must call `canSetObjectiveValue` before changing the objective value because changing the objective value is not allowed during some run states such as ramp down.

# Modify objective value on the fly every 40s (3rd one should give a warning)

```
set maxObjectiveValue [$Activity_newClientActivity1 getMaxObjectiveValue]puts "Max  
objective value - $maxObjectiveValue"
```

```
set objectiveValue 733100for {set j 0} {$j < 3} {incr j} {    sleep 40    puts "Try-  
ing to change objective to $objectiveValue..."    $Activity_newClientActivity1 con-  
fig -objectiveValue $objectiveValue    set canSetObjectiveValue [$Activity_  
newClientActivity1 canSetObjectiveValue]    if { $canSetObjectiveValue } {  
$Activity_newClientActivity1 applyObjectiveValues    }    incr objectiveValue 100}
```

### **collectDebugLogs**

This command places the debug logs in the `DebugInfo\Logs` directory of the configured results directory of the test configuration on the PC running the IxLoad client GUI. For example:

```
<ResultsDirectory>\ DebugInfo\Logs
```

Example:

```
$testController collectDebugLogs
```

### **enableAutoGenerateReport**

Automatically generates a report after the test stops. You must call this API before the test is configured. See `generateReport` for more information.

Values: 0 = false (default), 1 = true.

### **getTestServerHandle**

This subcommand returns a string used for statistics collection using the `statCollectorUtils::Initialize` command. IOR stands for Interoperable Object Refname given to a network-addressable reference as defined by CORBA.



## getMaxObjectiveValue

Fetches the maximum objective value that can be configured on the activity when the test is running. This value is shown as the maximum value that can be set using the Objective slider in the IxLoad GUI. See the example below and the example for `canSetObjectiveValue`.

Example:

```
proc ::my_stat_collector_command {args} {
    set ::ixStatCollectorMonitor "statsReceived"
}
${NS}::StartCollector -command ::my_stat_collector_command -interval 4

set ::ixTestControllerMonitor ""
$testController run $Test1

# wait till we get stats, indicating test is starting to run
vwait ::ixStatCollectorMonitor

set maxObjectiveValue [$Activity_newClientActivity1 getMaxObjectiveValue]
puts "Max objective value - $maxObjectiveValue"
```

## generateReport

This command performs the report generation from TCL. The `generateReport` function is called after a test is run and completed. The test run generates certain CSV files. These files are stored in the result directory and contain the test statistics. IxReporter processes the resulted CSVs and generates the PDF file.

A new version of IxReporter, the report generation application, was introduced with IxLoad 6.0. This new version provides new report options, but requires a slightly different workflow. The legacy (pre-6.0) report generation options are still supported.

### Legacy (pre-6.0) Report Generation

The legacy report generation options do not require the IxReporter GUI to be running in the background, and the only package that is required is the `ixload` package (`package require ixload`). The only legacy report generation options are:

```
-detailedReport
-format
```

To generate a legacy report, specify the `.rxf` file for the test, and the report options:

```
$testController run $test -autorepository <rxf Name>vwait
::ixTestControllerMonitor$testController releaseConfigWaitFinish$testController generateReport -detailedReport 1 -format PDF
```

### IxLoad 6.0 Report Generation

To use the IxLoad 6.0 report generation options, you use the same `generateReport` command with options you want, plus the following additional options:

- `enableAutoGenerateReport` automatically generates a report after the test stops.
- `addReportFile` adds a files to the report.
- `addReportFilesFromFolder` adds all the files in a folder to the report .

As an alternative to using the report generation APIs, you can use IxReporter standalone to manipulate test results and generate a report.

The IxLoad 6.0 report options require the `ixloadcsv` package to be loaded (`package require ixloadcsv`).

The complete code workflow for generating reports is as follows:

1. Launch the ixWish console from the installed build menu.
2. Call `"package require IxLoadCsv"`.
3. Call `"Source xxx.tcl"` where `xxx.tcl` is the file that contains the TCL reporter APIs for your test.
4. Determine when you want to call the report generation APIs:

Explicitly, after the test stops:	Automatically:
Call <code>generateReport</code> .	Call <code>enableAutoGenerateReport</code> .

5. Call the optional report generation APIs:  
`addReportFile`  
`addReportFilesFromFolder`
6. Access the location where the generated report is stored to retrieve the report file.

### **generateReport options**

`-detailedReport`

Type of report: summary or detailed. Summary reports are named "IxLoad Summary Report", detailed reports are named "IxLoad Detailed Report".

Values: 0 = summary (default), 1 = detailed.

`-format`

File format of report.

Values = "PDF" (default), "HTML", "PDF;HTML" (generates both), or HTML;PDF (generates both)

`-orientation`

Orientation of report.

Values: "Portrait" (default), "Landscape"

`-outputFile`

Path to which the test report is saved. If no path is specified, the report is saved in the default test results folder. For Unix users, report file is saved on the machine running the Tcl scripts.

Values: Full directory path, and file name without an extension. For example: "c:/temp/httpReport"

`-mailTo`

Email address to which the report is automatically mailed after generation.

Value: Valid email address. For example: "tester1@company.com". The default value is empty (null string).

`-testName`

Name of test in report.

Value: String. For example: "httpTest". The default value is the active test name in the rxf.

`-testerName`

Name of tester identified in report.

Value: String. For example: "ixia". The default is the tester name in the rxf.

`-dutName`

Name of the DUT in the report

Value: String. For example: "firewall". The default value is empty (null string).

`-highlights`

Applies highlighting-style formatting all instances of the specified string in the report.

Value: String. For example, if you specify: "Performance testing", all instances of the string "Performance testing" are highlighted in the report. The default is the active test comments in the rxf.

`-coverPageImageFile`

Image file to be used as the report's cover page.

Value: Full path of the image file.

`-qaCsv`

Reserved for internal use.

## **getRunResultDirFull**

The `getRunResultDirFull` returns the directory into which the generated report has been placed.

```
$testController generateReport -detailedReport lset resultDir [$testController
getRunResultDirFull]
```

## **isBusy**

Following a call to the `run` subcommand, this subcommand returns `true` while the test is still running.

## repository

Creates the repository that is used as the source of data for the “Test Configuration” section in a generated report. The repository is created in the results (`$resultDir`) directory.

For example, the following generates a repository using the configuration specified by the `ixRepository` object:

```
$testController run $test -repository $repository
```

The `autorepository` and `repository` subcommands can both be used to create repositories that are the source of data for the “Test Configuration” section of reports. For a description of the differences between them, see `autorepository`.

## retrieveFileCopy

Copies files from Windows to Linux. You can use `retrieveFileCopy` to retrieve files from the Windows file system.

```
set resultDir [$testController getRunResultDirFull]set remoteFile "$resultDir\IxLoad Detailed Report.pdf":IxLoad retrieveFileCopy $remoteFile /root/Report1.pdf
```

## run \$test

This command causes the test specified in `$test`, which must be an object of type `ixTest`, to start. After calling the `TestController run` function, your script must call `vwait ::ixTestControllerMonitor` to ensure that the Tcl event loop is processed. Otherwise, IxLoad will not call your statistics callback command, and you will not be able to tell when the test ends.

If you have a lot of processing to do after calling `run`, but before the test ends, your code may be executing when IxLoad sets the `::ixTestControllerMonitor` variable. Example 2 (see below) shows how to correctly handle detecting the end of test if this possibility exists.

## setResultDir \$dir

Specifies the location of where the execution results will be kept. If this subcommand is not called, no results will be stored. When running from a Unix client, this is a directory on the intermediate Windows host that the client connected to using the `connect` subcommand of `::IxLoad`. The `retrieveFile` or `retrieveFileCopy` subcommands of `::IxLoad` can be used to retrieve the files from the Windows host.

Within the directory you specify for `setResultDir`, IxLoad stores the following files for the current test:

```
Test_Client.csvTest_Server.csv<Protocol>_<Client|Server>.csv<Protocol>_<Client|Server>_Default_CSV_Logs_<activity name>_<traffic name>@<network name>.csvTest_Client.csvTest_Server.csv
```

`<Protocol>` is the name of the protocol (for example, HTTP). There will be a set of files for each protocol used in the test.

<Client|Server> is the side of the connection, client or server. There will be a set of files for each side used in the test.

<activity name> is the name of the activities (agents) appended to the agentList of the traffic.

<traffic name> is the name of the `ixCustomPortMap` or `ixServerTraffic` element created in the test.

<network name> is the name of the `ixDHCP` or `ixStatCatalogItem` element created in the test.

## startCapture

Starts packet capture. IxLoad automatically calls `startCapture` before the test starts running (when the nettraffics are being configured). If your script calls `startCapture` explicitly, you can start (or restart) capturing packets at any point in the test (provided you have first called `stopCapture` to stop a capture that is already running).

## stopCapture

Stops packet capture. IxLoad automatically calls `stopCapture` when the test finishes running. You can use `stopCapture` to stop capture at any point during the test, such as when the test enters the Configured state.

For example, the following script fragment captures only the packets generated during the Apply Config process:

```
# Start the test
$testController applyConfig $test
vwait ::ixTestControllerMonitor
puts $::ixTestControllerMonitor
$testController stopCapture
#
# Wait for the rest of the capture data
#
if {$::ixCaptureMonitor == ""} {
puts "Waiting for last capture data to arrive."
vwait ::ixCaptureMonitor
puts "Capture data received."
}
```

## stopRun

Stops the test. Any protocol sessions running at the time `stopRun` is issued are terminated as quickly as possible. To stop the test gracefully, use `stopRunGraceful`.

## stopRunGraceful

Stops the test, allowing the DUT to end any remaining protocol sessions. Because `stopRunGraceful` allows sessions to terminate naturally, the ramp-down phase of the test may be longer than if you use `stopRun`.

## OPTIONS

outputDir

If this is empty (""), then no result CSV files are saved. If this is not empty (for example, "1"), then CSV files are saved. (Default = "").

## EXAMPLE

```
# Example 1: First method of using vwaitset testController [::IxLoad new ixTestCon-
troller -outputDir 1]$testController setResultDir \
```

```
"[pwd]/RESULTS/simplehttpclientandserver"
```

```
# Run the test$testController run $testvwait ::ixTestController
```

```
#Example 2: Second method of using vwait. This method is useful if you have pro-
cessing you wish to do while the test is running.# Code to set up and define test
and testController# ...
```

```
# The following function is useful to delay while running# the Tcl event loop.proc
sleep {duration} {    after $duration {set wakeUp 1}    vwait wakeUp}
```

```
set ::ixTestControllerMonitor "$testController run $test
```

```
#    Other activities here. While waiting you must call#    either vwait or update to
ensure your statCollector command#    is called.
```

```
## wait, if necessary, until the test is over#while {[lsearch $::ixTestCon-
trollerMonitor TEST_STOPPED] == -1} {    sleep 1000}
```

```
puts $::ixTestControllerMonitor
```

## SEE ALSO

[ixTest](#)

## ixTestControllerMonitor

ixTestControllerMonitor-Global variable to wait on for test completion.

## SYNOPSIS

```
vwait ::ixTestControllerMonitor
```

## DESCRIPTION

The global variable `ixTestControllerMonitor` is maintained by `ixTestController` while a test is running. Its value may be `vwait`'d to determine when the test is complete.

`ixTestControllerMonitor` is set by IxLoad either at the end of the last `ixTestController` command (using either the `applyConfig` or `run` options). `ixTestControllerMonitor` will only be set while inside a `vwait` command or an update command.

The reason you should initialize `ixTestControllerMonitor` prior to issuing the test command is because it is `vwaiting` on something other than `ixTestConmonitor`, so you need to be able to detect the end of the test by examining the value of `::ixTestControllerMonitor`. Also, because it is not set by IxLoad prior to the end of the test (or `applyConfig`), it will be undefined otherwise.

Usually, you can use `vwait` or `ixTestControllerMonitor` directly, but if the script needs to do some other processing while the test is running, the following example from the `simplehttpconfigstoprun.tcl` sample script shows how this can be done.

In this example, the code waits for the first statistic to arrive, and then falls through if the test stops or the event occurs:

```
set ::ixTestControllerMonitor "" # initialize to known value
$testController run $test# do the command# wait for the first sample or test stop
while {$::ixTestControllerMonitor == "" && $::gotOneStat == 0} {after 1000 set wakeup 1
```

```
vwait wakeup# you have to call vwait (or update)
# periodically to allow IxLoad to run
}
```

While waiting for the test to finish, the script must call either `vwait` (as in the example) or `update` to allow the Tcl event loop to function.

`ixTestControllerMonitor` returns one of the following values:

```
{eventType TEST_STOPPED status OK}{eventType TEST_STOPPED status ERROR description
{1}}
```

If an error occurs, refer to the log file to determine the cause.

## EXAMPLE

See the example under `statCollectorUtils`.

## SEE ALSO

[statCollectorUtils](#)

[ixTestController](#)

## statCollectorUtils

`statCollectorUtils`-Handles statistics gathering.

## SYNOPSIS

package require statCollectorUtils

::statCollectorUtils::command args

## DESCRIPTION

The `statCollectorUtils` is a library containing several commands to gather statistics during a test run. The model for usage of these commands is:

- `Initialize` -Initializes the statistics utilities.
- `ClearStats` - Clears statistics from a previous run.
- `AddStat` - Adds a statistic to the list of statistics to be retrieved. Call this once per statistic.
- `AddL2L3Stat` - Adds a layer 2 or 3 statistic to the list of statistics to be retrieved. Call this once per statistic.
- `AddPerInterfaceStat` - Adds a per-range statistic to the list of statistics to be retrieved. Call this once per statistic.
- `AddSIPPerStreamStat` - Adds a SIP per-stream statistic to the list of statistics to be retrieved. Call this once per statistic.
- `AddVideoPerStreamStat` - Adds a video per-stream statistic to the list of statistics to be retrieved. Call this once per statistic.
- `AddNetworkStat` - Adds a network statistic to the list of network statistics to be retrieved. Call this once per statistic.
- `SetCsvVersion` - Allows the stat names written to the CSV to be the same as would be the case if generated by the given `buildNumber` or special constant.
- `SetCsvThroughputUnits` - Defines the units used for throughput statistics written to the CSV files.
- `StartCollector` -command `callbackCommand` -Starts the statistics collection process and indicates a callback command to invoke when statistics are delivered.
- Use `ixTestController run` to run the test.
- Use `vWait ::ixTestControllerMonitor` to wait for the test to end. During the run, the callback command indicated in `StartCollector` is called.
- `StopCollector` - Stops the statistics collection process.



**Note:** QoE Detective stats and the Network overview with their associated drill-downs are not supported in the Tcl API.

## COMMANDS

Unless otherwise described, no values are returned and an exception is raised for any error found.



**AddStat arguments**

Adds a statistic to the list of desired responses. The arguments to this command are `-option value` pairs:

Option	Usage
<code>aggregationType</code>	<p>Specifies how statistics for multiple ports, as indicated in the <code>filter</code> argument, are combined. One of:</p> <ul style="list-style-type: none"> <li>• <code>"kSum"</code>-Adds all of the statistics together.</li> <li>• <code>"kMax"</code> -Determines the maximum value.</li> <li>• <code>"kMin"</code>-Determines the minimum value.</li> <li>• <code>"kAverage"</code>-Determines the average value.</li> <li>• <code>"kWeightedAverage"</code>-This type is for use with weighted statistics. The statistics descriptions indicate whether they are weighted or not.</li> <li>• <code>"kRate"</code> -Determines the rate of change of the sum of all the statistics.</li> <li>• <code>"kMaxRate"</code> -Determines the maximum rate.</li> <li>• <code>"kMinRate"</code>-Determines the minimum rate.</li> <li>• <code>"kAverageRate"</code>-Determines the average rate.</li> <li>• <code>"kString"</code>-Treats as a string.</li> </ul>
<code>caption</code>	The caption associated with the statistic. This is not currently used by the Tcl API, but a comment must be supplied.
<code>enumerated</code>	<p>If <code>true</code>, returns a list of stats as follows:</p> <ul style="list-style-type: none"> <li>• HTTP Client: Returns one stat in the callback for each different URL in the client's command list.</li> <li>• HTTP Server: Returns one stat in the callback for each defined server page.</li> </ul> <p>If <code>false</code> (default), returns a single stat for all URLs.</p>

filterList	<p>A list of filter items that specifies the origin of the statistics to be filtered. You can format the <code>filterList</code> to gather statistics from one of the following components in the test:</p> <pre>{Port {Chassis&lt;chassis_id&gt;/Card&lt;card_id&gt;/Port&lt;port_id&gt; ... } } {Card {Chassis&lt;chassis_id&gt;/Card&lt;card_id&gt; ... } } {Chassis {Chassis&lt;chassis_id&gt; ... } } {Community {&lt;net_traffic_name&gt; ... } } {Activity {&lt;net_traffic_name&gt; - &lt;activity_name&gt; ... } }</pre> <p>For the Activity filter, the spaces on either side of the "-" are required. Also, for <code>net_traffic_name</code>, use the full name of the nettraffic. For example, "client_traffic@client_network". For <code>activity_name</code>, use the configured name of the activity. For example, "HTTPClient1".</p> <p>If <code>filterList</code> is empty, no statistics are filtered out.</p>
statName	<p>The name of a specific statistic, as listed in the <code>Statistics</code> topic of the statistics page for the protocol client or server agent. For example, the list of statistics for HTTP Clients can be found in the <code>Statistics</code> topic at <code>HTTP Client Agent</code>.</p>
statSourceType	<p>The agent type that generates the statistics. This is a two part name of the form: <code>Protocol Client Server</code></p> <p>Where <code>Protocol</code> is one of the supported protocols-for example, HTTP or FTP, and <code>Client/Server</code> is one of those two values. Some examples are: <code>"HTTP Client"</code> <code>"FTP Server"</code></p>

### AddL2L3Stat arguments

Adds a layer 2 or 3 statistic to the list of network statistics to be retrieved.

The arguments to this command are similar to those for `AddStat`. The arguments to this command are `-option value` pairs:

Option	Usage
aggregationType	See <code>AddStat</code> for description.
caption	See <code>AddStat</code> for description.

filterList	<p>A list of filter items that specifies the origin of the statistics to be filtered.</p> <p>Unlike the other Add&lt;&gt;Stat commands, AddL2L3Stat only allows filtering statistics from ports, and requires the chassis IP address in the filter instead of the chassis ID. The format for filtering L2/L3 statistics from a port is:  {Port {&lt;chassis_ip&gt;/Card&lt;card_number&gt;/Port&lt;port_number&gt; ... }}</p> <p>For example, to filter statistics from ports 2 and 3 on card 2 of a chassis whose IP address is 10.200.1.1:</p> <pre>-filterList {Port {10.200.1.1/Card2/Port2 10.200.1.1/Card2/Port3}}</pre>
statName	See AddStat for description.
statSourceType	<p>The network plugin that generates the statistics.</p> <p>For AddL2L3Stat, the only available statSourceType is:  "PortMonitor"</p>

### AddNetworkStat arguments

Adds a dynamic range network statistic to the list of network statistics to be retrieved.

Note: If you want to create a sample script using ScriptGen, the network statistics are not available until the test configuration has been downloaded to the Ixia ports. You can use the `Apply Config` command to download the test configuration to the ports without starting the test.

The arguments to this command are similar to those for AddStat. The arguments to this command are -option value pairs:

Option	Usage
aggregationType	See AddStat for description.
caption	See AddStat for description.
filterList	See AddStat for description.
statName	See AddStat for description.

statSourceType	<p>The network plugin that generates the statistics. For example: "IPSec" The list of network plugin names is:</p> <ul style="list-style-type: none"> <li>• WebAuth</li> <li>• 802.1x</li> <li>• EAPoUDP</li> <li>• IPSec</li> <li>• L2TP_PPP/PPP</li> <li>• L2TP_PPP/PPPoE</li> <li>• GTP</li> <li>• 3GPP</li> <li>• IMPAIR</li> </ul>
----------------	---

### AddPerInterfaceStat arguments

This is the utility for per-range interface statistics.

To activate this statistics for the client and the server, enable IP interface (`enableStats`) statistics in the client and the server network.

Option	Usage
statSourceType	<p>The agent type that generates the per interface statistics. This is a two part name of the form: Interface Protocol - Client Server Where Protocol is IPV4 or IPV6 and Client Server is one of those two values. Some examples are: "Interface IPv4 Client" "Interface IPv4 Server" "Interface IPv6 Client" "Interface IPv6 Server"</p>
statList	<p>This is a list of statistical names and aggregations function pair. An example of IPV4: <code>-statList {"Packets Sent" "kSum"} {"Packets Received" "kSum"} \</code></p>
ipList	<p>This is the list of IPs specified for the client and the server for collecting the statistics. <code>-ipList {"198.18.2.1" "198.18.2.2"}</code></p>

For each address that you specify in ipList, IxLoad records the statistics specified in statList.

For example, if you specify an ipList and statList as follows:

```
-statList {"Packets Sent" "kSum"} {"Packets Received" "kSum"} \-ipList
```

```
"198.18.2.1" "198.18.2.2"
```

and a returned list of statistics contains the following:

```
{{kInt 28112} {kInt 0} {kInt 31973} {kInt 0}}
```

{kInt 28112} is the statistic for Packets Sent for address 198.18.2.1.

{kInt 0} is the statistic for Packets Received for address 198.18.2.1.

{kInt 31973} is the statistic Packets Sent for address 198.18.2.2.

{kInt 0} is the statistic for Packets Received for address 198.18.2.2.

Because IxLoad adds the statistics in the order specified by statList for every address in ipList, you can parse the list of statistics returned by callback (see the StartCollector command) to obtain any specific statistic.

### AddSIPPerStreamStat arguments

This is the utility for SIP per stream statistics.

Option	Usage
statSourceType	The agent type that generates the per stream statistics. This is a two part name of the form: SIP Client/Server Per Stream Some examples are: "SIP Client Per Stream""SIP Server Per Stream"
statList	This is a list of statistic name and aggregation function pair. statList - list of {statName, aggregationFunction} like {"Packets" "kSum"} {"Mos_Value" "kString"}
instanceList	This is the list of packets specified for the SIP port for collectthe statistics. list of {port, sipClientAgentName, index of Caller or Called}

### AddVideoPerStreamStat arguments

This is the utility for video per stream statistics.

Option	Usage
statSourceType	The agent type that generates the per stream statistics. This is a two part name of the form: Video Client/Server Per Stream For example: "Video Client Per Stream""Video Server Per Stream"

statList	This is a list of statistic name and aggregation function pair. list of {statName, aggregationFunction}\
instanceList	This is the list of packets specified for the video port for collecting the statistics. list of {port, videoClientAgentName, index of User, index of Entry}

## ClearStats

Clears all statistical data from a previous or aborted run.

## Initialize -testIOR \$testIOR

Initializes the statistics utility package. `$testIOR` is the value returned from a call to `ixTestController's getTestServerHandle` subcommand. See the following example:

```
set tc [::IxLoad new ixTestController]
::statCollectorUtils::Initialize -testIOR [$tc getTestServerHandle]
```

## SetCsvVersion <buildNumber>

Allows the stat names written to the CSV to be the same as would be the case if generated by the given `buildNumber` or special constant. The build number must be in dotted-quad notation (a.b.c.d). The build number is part of the installation path when IxLoad is installed, and is also available in the release notes for that release. `buildNumber` must be 5.0.117.0 or greater. If set to anything less than 5.0.117.0, the value is ignored.

Special Constant	Description
rx	Uses the build number of the version of IxLoad that most recently saved the repository. If the TCL API does not load a repository, then it uses the build number of the current instance of IxLoad.
current	Uses the build number of current instance of IxLoad in all cases.

```
set tc [::IxLoad new ixTestController]
::statCollectorUtils::SetCsvVersion 5.0.280.0
```

## SetCsvThroughputUnits <throughputUnits>

Defines the units used for throughput statistics written to the CSV files. `throughputUnits` can be one of: Bps (bytes per second, the legacy unit), Kbps, Mbps, or Gbps.

This overrides any `IxAppOption.ini` entry, allowing allowing your script to determine the units used for throughput statistics written to the CSV files.

## StartCollector -command tclCommand -interval value

Initiates the operation of the statistics collection process, registering the name of a user supplied command (`tclCommand`), which will be called at `-interval` when new statistics are received.

### Callback Command Invocation

The statistics callback interval (`-interval`) must be set manually. It is not set by the `csvInterval` parameter (see `ixTest`). To invoke the statistics callback, define the statistics as a set of name-value pair arguments of the form:

```
{timestamp 1102900690000 stats {{kInt 1659316} {kInt 58998232}}}
```

The pairs are:

Option	Usage
timestamp	The number of milliseconds from the time that the test started.
stats	A list of pairs, one per statistic registered with <code>AddStat</code> in the order registered. The first member of each pair indicates the data type of the value, one of: <ul style="list-style-type: none"> <li>• <code>kInt</code> -an integer value.</li> <li>• <code>kStr</code> -a string. For example: <code>{this is a string}</code>.</li> </ul>

## StopCollector

Stops the operation of the statistics collector.

### OPTIONS

None.

### EXAMPLE

```
#-----# Set up
stat Collection#-----
---set NS statCollectorUtilset ::test_server_handle [$testController getTestServer-
Handle]${NS}::Initialize -testServerHandle $::test_server_handle#-----
-----# Clear any stats that may have
been registered previously#-----
-----${NS}::ClearStats#-----
-----# Define the stats we would like to collect#-----
-----${NS}::AddStat \-caption "Watch_
Stat_1" \-statSourceType "HTTP Client" \-statName "HTTP Bytes Sent" \-aggreg-
ationType kSum \-filterList {}

${NS}::AddStat \-caption "Watch_Stat_2" \-statSourceType "HTTP Client" \-statName
"HTTP Bytes Received" \-aggregationType kSum \-filterList {}

${NS}::AddStat \-caption "Watch_Stat_3" \-statSourceType "HTTP Client" \-statName
```

```

"HTTP Time To Last Byte (ms)" \-aggregationType kWeightedAverage \-filterList {}

${NS}::AddStat \-caption "Watch_Stat_4" \-statSourceType "HTTP Client" \-statName
"HTTP Bytes Sent" \-aggregationType kRate \-filterList {}

${NS}::AddStat \-caption "Watch_Stat_5" \-statSourceType "HTTP Client" \-statName
"HTTP Bytes Received" \-aggregationType kRate \-filterList {}#-----
-----# Define the L2/L3 stats we would
like to collect#-----
---${NS}::AddL2L3Stat \-caption "Watch_Stat_L2L3_3" \-statSourceType "PortMonitor"
\-statName "Frames Sent" \-aggregationType kNone \-filterList {}#-----
-----# Define the network stats we
would like to collect#-----
-----

set ::netstatList { \{"IPSec" "Interface ID" "kString"} \{"IPSec" "Status"
"kString"} \{"IPSec" "NAT-T" "kString"} \{"IPSec" "DPD" "kString"} \{"IPSec"
"Total Retries" "kSum"} \{"IPSec" "Total Latency" "kSum"} \{"IPSec" "Encap-
sulation Protocols" "kString"} \{"IPSec" "Encapsulation Mode" "kString"} \
{"IPSec" "Initiator Subnet" "kString"} \{"IPSec" "Initiator IP Address"
"kString"} \{"IPSec" "Responder IP Address" "kString"} \{"IPSec" "Responder Sub-
net" "kString"} \}

foreach statItem $::netstatList {
    set caption [format "Watch_
Stat_%s" $count]
    set statSourceType [lindex $statItem 0]
    set statName [lindex
$statItem 1]
    set aggregationType [lindex $statItem 2]

    ${NS}::AddNetworkStat \-caption $caption \-statSourceType
$statSourceType \-statName $statName \-aggregationType $aggregationType
\-filterList {}

    incr count}

# Start the collector (runs in the tcl event loop)
proc ::my_stat_collector_command
{args} {
    puts "====="
    puts "INCOMING STAT
RECORD >>> $args"
    puts "Len = [llength $args]"
    puts [lindex $args 0]
    puts [lindex $args 1]
    puts "====="}

${NS}::StartCollector -command ::my_stat_collector_command -interval 2

#-----#
Run the test #-----#

```



---

```

----      $testController run $test

      #-----#
have the script (v)wait until the test is over  #-----#
-----

      vwait ::ixTestControllerMonitor;
puts $::ixTestControllerMonitor

      #-----#
      # Stop the collector (running in the tcl event loop)
      #-----#
${NS}::StopCollector

```

**SEE ALSO**[ixTestController](#)[ixTestControllerMonitor](#)[ixTest](#)

## ixScriptGen

ixScriptGen-Generates a tcl script (TCL file).

**SYNOPSIS**

```
set scriptGenObj [::IxLoad new ixScriptGen]
```

**DESCRIPTION**

A scriptGen object is created and configured. scriptGen can generate a Tcl script for the following:

- Complete test
- NetTraffics
- Activities
- Networks

**SUBCOMMANDS**

None.

**OPTIONS**

fileName

Specifies the name and path of the script to be generated.

```
includeStats
```

If `true`, the script includes code to record the default statistics for each activity in the test. If `false`, the script does not include any code to record statistics.

```
configSetting
```

This option determines whether or not the generated script includes code that sets the test control options to their default values.

Option	Usage
<code>kConfigWriteAll</code>	Generates a script that includes all the test control code, including code that sets the configuration options to their default val
<code>kConfigComment</code>	Generates a script that comments out test control code that sets options to their default values.
<code>kConfigOmit</code>	Generates a script that only includes test control code for options set to non-default values.

## EXAMPLE

```
# Scriptgen for a complete script#-----
-----"if {$::tcl_platform(platform) == "windows"} {package require registry lset
::_IXLOAD_INSTALL_ROOT [registry get {HKEY_LOCAL_MACHINE\Software\Ixia Com-
munications\IxLoad\InstallInfo} HOMEDIR]set ::_IXLOAD_PKG_DIR [file join $::_IXLOAD_
INSTALL_ROOT Client tclex t teepee stage]

lappend ::auto_path $::_IXLOAD_PKG_DIR}package require IxLoad::IxLoad connect
1.2.3.4if [catch {set logtag "IxLoad-api"}]set logName "scriptgen"}set logger [::IxLoad
new ixLogger $logtag 1]set logEngine [$logger getEngine]$logEngine setLevels
$::ixLogger(kLevelDebug) $::ixLogger(kLevelInfo)$logEngine setFile $logName 2 256 1

#-----# Create a test con-
troller bound to the previously allocated# chassis chain. This will eventually run
the test we created earlier.#-----
-----set testController [::IxLoad new ixTestController -outputDir 1]$testCon-
troller setResultDir "[pwd]/RESULTS/reprun"## Load the repository#set repository
[::IxLoad new ixRepository -name {E:\ixweb\ixweb\3.20\automation\B2B_310_IMAP_RTSP_
TELNET_POP\Repository\IMAP_dns_all_atomic_level_cmd_ipv4.rxf}]

set testName [$repository testList(0).cget -name]set test [$repository testList.-
getItem $testName]
```

```

set scriptGenObj [::IxLoad new ixScriptGen]$scriptGenObj config \
-fileName {E:\ixweb\ixweb\3.20\automation\B2B_310_IMAP_RTSP_TELNET_POP\Re-
pository\IMAP_dns_all_atomic_level_cmd_ipv4_new.tcl} \
-includeStatsFalse \
-configSetting$::ixScriptGen(kConfigWriteAll)
$scriptGenObj scriptGen $test}] {puts $errorInfo}::IxLoad disconnect

```

## SEE ALSO

[ixNetTraffic](#)

## ixTimeline

ixTimeline-Configures the time in the test when the activities in the NetTraffics come online, and how long they stay up for. It is also used to configure the test's objectives.

### SYNOPSIS

```

set Activity_HTTPClient1 [$Traffic1_Network1 activityList.appendItem options...]
set Timeline [::IxLoad new ixTimeline] options...

```

### DESCRIPTION

The `ixTimeline` command is used to create a test scenario. It controls the times and rates at which Activities come online (`rampUp`), the length of time they stay up for (`sustainTime`), and the rate at which they go offline (`rampDown`).

### There are two types of Timelines:

**Basic:** A Basic timeline controls activities linearly -- the `rampUp`, `sustain`, and `rampDown` phases are straight lines, and the `rampUp`, `sustain`, and `rampDown` occur at steady rates, either increasing (`rampUp`), static (`sustain`) or decreasing (`rampDown`).

**Advanced:** An advanced timeline allows you to plan the traffic shape to the `objectValue`, such as pulses or bursts. An Advanced timeline displays the `rampUp`, `sustain`, and `rampDown` phases as segments. There are five types of segments:

**Linear:** a constant-slope segment that starts with the current objective value and ends at the End Objective Value value.

**Step:** a classic stair step pattern that starts with the current objective value and ending after a number of fixed deltas.

**Burst:** a burst segment starts with the current objective value and ends to the same objective value. Burst segments produce a symmetrical triangular shape fluctuation.

**Pulse:** a pulse segment starts with the current objective value and ends to the same objective value. Pulse segments produce a symmetrical pulse shape fluctuation, with an increase in rate, a duration of time spent at the new peak and then drop to the starting value.

**Poisson:** a poisson segment introduces a logarithmic noise element into the objective value.

## SUBCOMMANDS

The options for this command are configured and read using the standard `config`, `cget`, and `getOption` subcommands defined in the `ixConfig` command.

## OPTIONS (BASIC TIMELINE)

`rampUpValue`

Value applied to `rampUpType` to either bring up users at a certain rate (Users per second or to maintain a pool of users waiting to establish connections (MaxUsers).

`rampUpType`

Ramp-up type used by timeline. One of:

Value	Description
-2	Mixed (may be displayed when ramp-up value is retrieved for a community of mixed activities)
-1	N/A
0	Users per second
1	Maximum pending users
2	Smooth users

`offlineTime`

The amount of time agents are idle between iterations. (Default = 0). This is also applicable to advanced timeline.

`rampDownTime`

Amount of time used for closing any TCP connections that are still open after all transactions are complete. `rampDownTime` applies only to client activities.

`standbyTime`

The amount of time, expressed in seconds, that elapses between the time the test is started and the time that the traffic-network pair become active. The valid range is from 0 to 1,000 hours (3,600,000). (Default = 0). This is also applicable to advanced timeline.

iterations

The number of times that the traffic-network pair perform their functions (establishing TCP connections, retrieving FTP files, and so forth) in the test. (Default = 1). This is also applicable to advanced timeline.

rampUpInterval

This field accepts integer values. The value for this option will be considered only when `rampUpType` is `usersPerSecond`. You can edit the value to increment or decrement the number of users to be started at every `rampUpInterval`. (Default = 1).

sustainTime

Amount of time when all users are up and performing the central test objectives, such as retrieving or serving pages (HTTP), or sending or receiving files (FTP).

timelineType

Denotes the type of phase in a section of the timeline. This is also used with the advanced timeline options.

name

Name of the Timeline.

## OPTIONS (ADVANCED TIMELINE)

### ixLinearTimeSegment

duration

The length of time that the segment lasts.

noiseAmplitudeScale

Amount of Gaussian noise added during the segment.

No noise is added to the last point in the segment so that the segment can end at the specified End Objective Value

endObjectiveScale

The value of the objective at the end the segment.

### ixPoissonTimeSegment

duration

The length of time that the segment lasts

averageScale

Number used to compute the Poisson distribution for the segment

noiseAmplitudeScale

Amount of Gaussian noise added during the segment.

No noise is added to the last point in the segment so that the segment can end at the specified End Objective Value

### **ixPulsesTimeSegment**

amplitudeIncrementStepScale

Additional gain in height (amplitude) from one pulse to the next.

pulseRampDownDuration

Amount of time allocated to the ramping-down of the pulse.

pulseRampUpDuration

Amount of time allocated to the rising edge of the pulse.

numberOfRepetitions

Number of steps. Minimum of 1.

pulseOfflineDuration

Time between pulses.

pulseSustainDuration

Length of time that the pulse occupies at the new peak value.

noiseAmplitudeScale

Amount of Gaussian noise added during the segment.

No noise is added to the last point in the segment so that the segment can end at the specified End Objective Value.

startingPulseAmplitudeScale

Height (amplitude) of the first pulse.

### **ixBurstsTimeSegment**

noiseAmplitudeScale

Amount of Gaussian noise added during the segment.

No noise is added to the last point in the segment so that the segment can end at the specified End Objective Value

numberOfRepetitions

Number of steps. Minimum of 1

startingBurstHeightScale

Height (amplitude) of the first burst.

burstIncrementStepScale

Additional gain in height (amplitude) from one burst to the next.

burstDuration

Length of time that the burst occupies

burstSkew

Bias applied to the burst curve:

Symmetric: No bias (curve has identical slopes on both sides).

Left: Curve is biased to the left (left side of the curve is steeper than the right).

Right: Curve is biased to the right. (right side of the curve is steeper than the right)

burstOfflineDuration

Time between bursts.

### **ixStepsTimeSegment**

stepHeightScale

Height of the step.

noiseAmplitudeScale

Amount of Gaussian noise added during the segment.

No noise is added to the last point in the segment so that the segment can end at the specified End Objective Value

stepSustainDuration

Length of time spent at the new peak objective value.

stepRampDuration

Length of time allocated to the rise to the new peak value.

numberOfRepetitions

Number of steps. Minimum of 1.

### **EXAMPLE**

```
set Steps_Segment_0 [::IxLoad new ixStepsTimeSegment]$Steps_Segment_0 config \ -
```

```
stepHeightScale          0.1 \ -noiseAmplitudeScale
0.0 \ -stepSustainDuration      20 \ -stepRampDuration
20 \ -numberOfRepetitions      3
```

```
$my_ixAdvancedIteration appendSegment $Steps_Segment_0
```

```
set Bursts_Segment_1 [::IxLoad new ixBurstsTimeSegment]$Bursts_Segment_1 config \ -
noiseAmplitudeScale          0.0 \ -numberOfRepetitions
3 \ -startingBurstHeightScale 0.1 \ -burstIncrementStepScale
0.1 \ -burstDuration          20 \ -burstSkew
0 \ -burstOfflineDuration     20
```

```
$my_ixAdvancedIteration appendSegment $Bursts_Segment_1
```

```
set Pulses_Segment_2 [::IxLoad new ixPulsesTimeSegment]$Pulses_Segment_2 config \ -
amplitudeIncrementStepScale 0.1 \ -pulseRampDownDuration t
```

## SEE ALSO

[ixNetTraffic](#)

## ixSubscriberNetTraffic

ixSubscriberNetTraffic-Special type of NetTraffic that simulates the traffic patterns created by residential customers that receive voice, video, and data service (Triple-play) over a single physical connection (usually a cable or DSL connection).

### SYNOPSIS

```
set Subscriber1_Network1 [::IxLoad new ixSubscriberNetTraffic]
```

### DESCRIPTION

Configuring an ixSubscriberNetTraffic is similar to configuring an ixNetTraffic. However, there are some differences:

Network and Protocols: Configuring a Subscriber is similar to configuring a NetTraffic. However, only the following protocols are supported:

DHCP	FTP	HTTP	IMAP
IPTV/ Video	LDAP	MGCP	POP3
RADIUS	RTSP	SIP	SMTP
SSH	TraceFileReplay	Telnet	DNS



objectiveType: The only objectiveType available for a Subscriber is simulatedUsers.

## OPTIONS

Refer `ixNetTraffic` for information on the options.

## EXAMPLE

```
set Subscriber1_Network1 [::IxLoad new ixSubscriberNetTraffic]set Subscriber_Activity_HTTPClient1 [$Subscriber1_Network1 activityList.appendItem \-protocolAndType "HTTP Client" ]$Subscriber1_Network1 config \-enable true \-network $Network1$Subscriber1_Network1 traffic.config \-name "Subscriber1"
```

## SEE ALSO

[ixNetTraffic](#)

`ixBandwidthLimit`

## ixNetTraffic

ixNetTraffic-Define client and server traffic.

## SYNOPSIS

```
set HTTP_client_client_network [::IxLoad new ixNetTraffic]
```

## DESCRIPTION

The `ixNetTraffic` command is used to configure client or server traffic. Two separate `ixNetTraffic` objects have to be created for client and server traffic. The `ixNetTraffic` configuration also declares the `ixNetworkGroup` object. The `activityList` options are also configured.

You can copy objects from used `NetTraffic` to another. See `duplicate` (see "[duplicate](#)").

## OPTIONS

### Enabling Options

`enable`

This enables the client or server network.

`network`

This specifies the name of the client or server network object.

### activityList Configuration Options

`enable`

If true, this mapping is included in the `IxLoad` test. (Default = true).

name

Name of the activityList config object. Default = "newClientActivity1".

enableConstraint

Currently, constraints can be set on activities that run rate-based objectives, like connectionRate, transactionRate, throughput objectives. This option enables the constraint. Default = false.

constraintValue

If enableConstraint is true, this option defines the constraint value. Default =100.

timeline

Represents the name of the ixTimeline object.

userObjectiveType

userObjectiveType is the recommended way to set the objective. This is the Objective Type that is displayed in the GUI, and should be the most meaningful. Changing the userObjectiveType will result in an automatic change to the objectiveType.

For most protocols, the userObjectiveType and the objectiveType are the same, but protocols can define their own userObjectiveTypes when it makes sense to do so. For example, SIP defines the *channels* userObjectiveType that corresponds to an underlying objectiveType of simulatedUsers. See the individual protocols for a description of the userObjectiveTypes they accept and how they are translated to the objectiveType.

Option	Usage
userAgents	The objective is to sustain some number of SIP calls simultaneously. Specify the desired number of UserAgents in the objectiveValue option.
callsPerSecond	The objective is to establish a certain number of SIP calls per second. Specify the desired number of calls to establish per second in the objectiveValue option.
bhca	The objective is to establish a certain number of SIP calls per hour. Specify the desired number of calls to establish per hour in the objectiveValue option. Busy hour call attempts (BHCA) is a standard measure of the number of calls completed during a busy hour, the 60-minute period when the maximum traffic load occurs within a given 24-hour period.
registrationsinitiated	The objective is to establish a certain number of call registrations of SIP. Specify the desired number of registrations in the objectiveValue option.

redirectionsinitiated	The objective is to establish a certain number of call redirections of SIP. Specify the desired number of redirections in the objectiveValue option.
transactionAttemptRate	The objective is to issue some number of DNS query per second. The number of DNS query is mentioned in the userObjectiveValue option.
queriespersecond	The desired number of DNS query per second.
connectionAttemptRate	The objective is achieved if IxLoad succeeds in making the specified number of attempts to connect to the HTTP server or DUT. Specify the desired number of attempted connections per second in the userObjectiveValue option.
streams	The objective is to monitor some number of multicast or unicast video or audio streams. Specify the desired number of streams in the userObjectiveValue option.

userObjectiveValue

The test objective value applied to the userObjectiveType. Default=100.

Note that some protocol-specific objectiveTypes apply scaling values to the value.

- bhca is mapped to transactionRate with a scaling factor of 3600.
- callsPerSec is mapped to transactionRate with a scaling factor of 1.
- userAgents is mapped to simulatedUsers with a scaling factor of 1.
- registrationsinitiated is mapped to transactionRate with a scaling factor of 1.
- redirectionsinitiated is mapped to transactionRate with a scaling factor of 1.

objectiveValuePercent

Expresses the objective of the NetTraffic or agent as a percentage of the userObjectiveValue. (Default="")

If you use ScriptGen to create a Tcl script, the ScriptGen allows you to script the test objective values as absolute values or as percentages of the overall test objective.

If you choose to script the objectives as percentages, the output depends on how the activities are grouped. If the activities are grouped by NetTraffic, the script will contain a user objective for the NetTraffic (the community) and a percentage value for each activity:

```
$TrafficIcl_Network1 config \
-enable true \
-totalUserObjectiveValue 200 \
-userObjectiveType "simulatedUsers" \
-tcpAccelerationAllowedFlag true \
-network $Network1

$Activity_HTTPClient1 config \
-secondaryConstraintValue 100 \
```

```
-enable true \  
-name "HTTPClient1" \  
-userIpMapping "1:1" \  
-enableConstraint false \  
-objectivePercent 50.0 \  
-timerGranularity 100 \  
-secondaryEnableConstraint false \  
-constraintValue 100 \  
-secondaryConstraintType "TransactionRateConstraint" \  
-constraintType "ConnectionRateConstraint" \  
-destinationIpMapping "Consecutive" \  
-timeline $Timeline1
```

If the grouping is by objective type, the script will contain a `totalUserObjectiveValue` that sets the total of the objective values for all the activities, followed by a list of <objective type, objective value> pairs and an `objectivePercent` option that sets the percentage value assigned to each activity.

```
$Test1 totalUserObjectiveInfoList.clear  
set my_ixTotalUserObjectiveInfo [::IxLoad new ixTotalUserObjectiveInfo]  
$my_ixTotalUserObjectiveInfo config \  
-userObjectiveType "Simulated Users" \  
-totalUserObjectiveValue 200  
  
$Test1 totalUserObjectiveInfoList.appendItem -object $my_ixTotalUserObjectiveInfo  
  
$Activity_HTTPClient1 config \  
-secondaryConstraintValue 100 \  
-enable true \  
-name "HTTPClient1" \  
-userIpMapping "1:1" \  
-enableConstraint false \  
-objectivePercent 50.0 \  
-timerGranularity 100 \  
-secondaryEnableConstraint false \  
-constraintValue 100 \  
-secondaryConstraintType "TransactionRateConstraint" \  
-constraintType "ConnectionRateConstraint" \  
-userObjectiveType "simulatedUsers" \  
-destinationIpMapping "Consecutive" \  
-timeline $Timeline1
```

`totalUserObjectiveValue`

Total objective value of all the activities in the NetTraffic that have the same objective type. See `objectiveValuePercent`. (Default="")

### Traffic Map Setup Options

`portMapPolicy`

This option controls the sequence in which the client ports connect to the server ports. One of:

Option	Usage
<code>\$.:ixPortMap</code> ( <code>kPortMapRoundRobin</code> ) or <code>"portPairs"</code>	(Default) . Client agents connect to server agents on a one-to-one basis.
<code>\$.:ixPortMap</code> ( <code>kPortMapFullMesh</code> ) or <code>"portMesh"</code>	Agents on every client port connect to every server port.
<code>\$.:ixPortMap</code> ( <code>kPortMapIpPair</code> ) or <code>"ipPair"</code>	Each simulated user on the client side comwith only one server IP address. This choice is only valid for SIP agents.
<code>\$.:ixPortMap</code> ( <code>kPortMapCustom</code> ) or <code>"custom"</code>	Each custom port map has a list of IPv4 subband IPv6 submaps. You can create a Custom traffic map. In a Custom traffic map, you select the client and server IP address ranges that will send traffic to each other.  To create a Custom traffic map, the subnet's <code>rangeType</code> parameter must be set to <code>IP Only (Ethernet)</code> .

For large numbers of ports, the Port Pair sequence scales performance better than the Port Mesh sequence.

The operation of Port Pairs can be described by three scenarios:

- If the number of client ports is equal to the number of server agents, client ports will establish connections to server ports on a one-to-one basis.
- If the number of client ports is less than the number of server ports, the client ports will establish connections to the server ports on a one-to-one basis until all client ports are paired with server ports. The remaining server ports will not be used.
- If the number of client ports is greater than the number of server ports, the client ports will establish connections to the server ports on a one-to-one basis until all server ports are paired with client ports. Then, the remaining client ports will return to the first server port and continue pairing themselves with server ports.

The `ixCustomPortMap` customizes the order and frequency, by which client IPs will access server IPs.

Each custom port map has a list of IPv4 submaps and IPv6 submaps. There will be a list for the appropriate IP type if any ranges of that type appear in the network for the symbolic destination. When a submap list is initialized, it will have a single submap that will be a full IP mesh, if that type is available. If only VLAN maps are allowed, then it will be a vLAN pairs map instead. If a submap is appended to the list, by default it will be a copy of the last submap in the list, unless values are passed in.

```
set destination [$HTTP_client_client_network getDestinationForActivity "newClientActivity1" "HTTP_server_newServerActivity1"]$destination config \-portMapPolicy
```

```
"portMesh"
```

## Configuring Traffic

```
name
```

The configuration that is set in the `protocolAndType` option for `activityList`.

```
$HTTP_client_client_network traffic.config \-name  
"HTTP client"$Client elementList.appendItem -object $HTTP_client_client_network
```

### EXAMPLE

```
set HTTP_client_client_network [::IxLoad new ixNetTraffic]  
$HTTP_client_client_network config \  
-enable 1 \  
-network $client_network  
$HTTP_client_client_network traffic.config \  
-name "HTTP client"  
$Activity_newAgent1 config \  
-enable 1 \  
-name "newClientActivity1" \  
-enableConstraint false \  
-userObjectiveValue 100 \  
-constraintValue 100 \  
-userObjectiveType "simulatedUsers" \  
-timeline $Timeline1  
$Client elementList.appendItem -object $HTTP_client_client_network  
#####  
# Destination newServerActivity1 for newClientActivity1  
#####  
set destination [$HTTP_client_client_network getDestinationForActivity "newClientActivity1" "HTTP  
server_newServerActivity1"]  
$destination config \  
-portMapPolicy "portMesh"
```

**SEE ALSO**[ixSubscriberNetTraffic](#)**activityList**

activityList-Generates traffic for one side of a particular protocol. For example, an HTTP client Activity generates HTTP client requests, simulating a web browser.

**SYNOPSIS**

```
set HTTP_client_client_network [::IxLoad new ixNetTraffic]set Activity_newAgent1
[$HTTP_client_client_network activityList.appendoptions..]
```

**DESCRIPTION**

The `activityList` is used to generate traffic for one side of a particular protocol.

An Activity is added to the `ixNetTraffic` object using `appendItem` subcommand. Agents are added to the activity using the `agent.config` subcommand.

The `protocolAndType` is a required field. These define a particular type of agent; and the side of the communication. The agent definition should include options which are specific to a particular protocol, and defined in their respective appendix.

**OPTIONS**

`protocolAndType`

Protocol is the name of the protocol (for example, HTTP). Type denotes the side of the connection, that is, client or server.

**EXAMPLE**

```
set HTTP_client_client_network [::IxLoad new ixNetTraffic]#-----
-----# Activity newAgent1 of NetTraffic HTTP cli-
ent@client network#-----set
Activity_newAgent1 [$HTTP_client_client_network activityList.appendItem \-
protocolAndType "HTTP Client" ]
```

**SEE ALSO**[ixNetTraffic](#)**ixTrafficFlow**

ixTrafficFlow-Lists the test scenario.

## SYNOPSIS

```
set TrafficFlow1 [::IxLoad new ixTrafficFlow]$TrafficFlow1 config \ options...
```

## DESCRIPTION

The `ixTrafficFlow` command is used to list the test scenario. Traffic Flow object is appended to the `ixTest` object.

## SUBCOMMANDS

The options for this command are configured and read using the standard `config`, `cget`, and `getOption` subcommands defined in the `ixConfig` command.

## OPTIONS

name

This represents the name of the `trafficflow` object.

## EXAMPLE

```
set TrafficFlow1 [::IxLoad new ixTrafficFlow]$TrafficFlow1 config \  
-name "TrafficFlow1"  
$TrafficFlow1 columnList.clear
```

## SEE ALSO

## ixTrafficColumn

`ixTrafficFlow`-A container of `ixNetTraffic` and `ixDut` objects.

## SYNOPSIS

```
set TrafficFlow1 [::IxLoad new ixTrafficFlow]  
$TrafficFlow1 config \ options...
```

## DESCRIPTION

The `ixTrafficColumn` command is used to define and configure client, server and DUT objects. The client, server and DUT objects are appended to the `ixTrafficFlow` object.



## SUBCOMMANDS

The options for this command are configured and read using the standard `config`, `cget`, and `getOption` subcommands defined in the `ixConfig` command.

## OPTIONS

`name`

This represents the name of the `trafficcolumn` object.

## EXAMPLE

```
set Client [::IxLoad new ixTrafficColumn]$Client config \
-name "Client"
$Client elementList.clear$TrafficFlow1 columnList.appendItem -object $Clientset DUT
[::IxLoad new ixTrafficColumn]$DUT config \
-name "DUT"
$DUT elementList.clear$TrafficFlow1 columnList.appendItem -object $DUTset Server
[::IxLoad new ixTrafficColumn]$Server config \-name
"Server"$Server elementList.clear$TrafficFlow1 columnList.appendItem -object $Server
```

## SEE ALSO

[ixTrafficFlow](#)

## ixNetworkGroup

`ixNetworkGroup`-Configures the client and server network.

## SYNOPSIS

```
set network [::IxLoad new ixNetworkGroup options]$network config \ options...
```

## DESCRIPTION

The `ixNetworkGroup` object is used to configure the client and server network. The client or server network is used by the `ixNetTraffic` object to map to the `nettraffic`.

## SUBCOMMANDS

The options for this command are configured and read using the standard `config`, `cget`, and `getOption` subcommands defined in the `ixConfig` command.

## OPTIONS

The main options for this command are described in `ixDHCP` and `ixStatCatalogItem`. Additional options are listed below.

`aggregation`

On a card that supports aggregating ports such as the ASM1000XMV12X, this option sets the port aggregation. If you set the aggregation mode to 1G, you must set the active port (see `activePortList`).

The following values are supported for `aggregation`:

Value	Enum	Description
<code>kNonAggregated</code>	0 (default)	Not aggregated
<code>k1GAggregated</code>	1	1G Aggregated
<code>k10GAggregated</code>	2	10G Aggregated

For example:

```
$Net_Traffic1 config \  
-aggregation 1
```

For an example of how to use an aggregating load module in a script, see the example in the Tcl API \ Samples \ Network directory.

`activePortList`

List of active ports in a group of 1G aggregated ports. For each NetTraffic that uses 1G aggregated ports, there must be an `activePortList` that defines the active port. If ports from multiple cards are aggregated, there must be an active port for each card. Example:

```
$Net_Traffic1 activePortList.appendItem \  
-chassisId 1 \  
-cardId 2 \  
-portId 1
```

---

**NOTE** Aggregation on Novus Load Modules can be performed only at card level. In this scenario the above rule to set aggregation as an option does not apply. In order to set aggregation on Novus Load Module the `setCardsAggregationMode` API needs to be called. This is exposed on the `chassisChain` object and receives as parameters the chassis IP or hostname, the ID of the card and the aggregation mode. For Novus, this is 10G in order to set 10G aggregated and NA in order

---

---

**NOTE** to set the board in non aggregated mode.

An example on how to set the card in 10G Aggregated mode is:

```
$chassisChain setCardsAggregationMode "10.215.122.231" "2" "10G"
```

---

## EXAMPLE

```
#-----# Network client network of NetTraffic HTTP client@client network#-----
-----set client_network [::IxLoad new ixNetworkGroup
$chassisChain]$client_network config \-comment "" \-
name "client network" \-emulatedRouterSubnetIPv6
"FFFF:FFFF:FFFF:FFFF:FFFF:FFFF::0" \-linkLayerOptions 0 \-
ipSourcePortFrom 1024 \-emulatedRouterGatewayIPv6
"::" \-cardType "ALM1000T8-1GB" \-
emulatedRouterGateway "0.0.0.0" \-ipSourcePortTo
65535 \-emulatedRouterSubnet "255.255.255.0" \-macMappingMode
0 \-dnsParameters $my_ixDns \-tcpParameters
$my_ixTcpParameters \-impairment $my_ixImpairment \-
arpSettings $my_ixArpSettings
```

## SEE ALSO

[ixNetworkRange](#)

## ixDut

ixDut-Defines a DUT.

## SYNOPSIS

```
set DUT1 [::IxLoad new ixDut]
$DUT1 subcommand options...
```

## DESCRIPTION

The `ixDut` command is used to define a DUT used in the test. The DUTs are used to resolve symbolic references in traffic destinations in the various protocol agents. It also controls several DUT specific features. DUTs are added to the `ixTest` object using `appendItem`. For example,

```
set DUT1 [::IxLoad new ixDut]$DUT1 config \
-comment "" \
-type "VirtualDut" \
-name "DUT1" \
```

```
-dutConfig $my_ixDutConfigVirtual
```

## SUBCOMMANDS

The options for this command are configured and read using the standard `config`, `cget`, and `getOption` subcommands defined in the `ixConfig` command.

## OPTIONS

`comment`

A comment associated with this DUT. (Default = "").

`name`

The name associated with the DUT. (Default = "DUT1").

`type`

The type of DUT in use. One of:

Option	Usage
<code>ExternalServer</code>	The DUT is a protocol server.
<code>ServerLoadBalancer</code>	The DUT is a server load balancer.(Default)
<code>Firewall</code>	The DUT is a firewall.
<code>VirtualDut</code>	The DUT is a virtual DUT

`dutConfig`

The object instance of the DUT `type`.

## EXAMPLE

```
set DUT1 [::IxLoad new ixDut]$DUT1 config \-comment  
"" \-type "VirtualDut" \-name  
"DUT1" \-dutConfig $my_ixDutConfigVirtual$DUT ele-  
mentList.appendItem -object $DUT1$New_Traffic_Flow columnList.appendItem -object  
$DUT
```

## SEE ALSO

[ixTest](#)

[ixStatCatalogItem](#)

## ixDutConfigVirtual

ixDutConfigVirtual-Configures a virtual DUT.

### SYNOPSIS

```
set my_ixDutConfigVirtual [::IxLoad new ixDutConfigVirtual]
$my_ixDutConfigVirtual subcommand options...
```

### DESCRIPTION

The `ixDutConfigVirtual` command is used to:

- Define a range of IP addresses for the DUT, instead of the single address that the other DUT Types allow.
- Specify the TCP/UDP ports that the Virtual DUT listens on, on a per-protocol basis.

Virtual DUTs are added to the `ixDut` object as an option. For example,

```
set my_ixDutConfigVirtual [::IxLoad new ixDutConfigVirtual]$my_ixDutConfigVirtual
config$my_ixDutConfigVirtual networkRangeList.clearset DUT1 [::IxLoad new
ixDut]$DUT1 config \
-comment "" \
-type "VirtualDut" \
-name "DUT1" \
-dutConfig $my_ixDutConfigVirtual
```

### SUBCOMMANDS

The options for this command are configured and read using the standard `config`, `cget`, and `getOption` subcommands defined in the `ixConfig` command.

### OPTIONS

`ixDutNetworkRange` and `ixDutProtocolPortRange` are appended to the `ixDutConfigVirtual` object.

### EXAMPLE

```
set my_ixDutConfigVirtual [::IxLoad new ixDutConfigVirtual]$my_ixDutConfigVirtual
config$my_ixDutConfigVirtual networkRangeList.clearset Network_Range_1_in_DUT1__1_1_
1_1_100_ [::IxLoad new ixDutNetworkRange]$Network_Range_1_in_DUT1__1_1_1_1_100_ con-
fig \-vlanUniqueCount 4094 \-firstIp
"1.1.1.1" \-enable true \-name
"Network Range 1 in DUT1 (1.1.1.1+100)" \-vlanEnable
true \-vlanId 1 \-innerVlanEnable
false \-ipIncrStep "0.0.0.1" \-networkMask
"255.255.0.0" \-ipType 1 \-vlanIncrStep
1 \-vlanCount 1 \-ipCount
```

```
100$my_ixDutConfigVirtual networkRangeList.appendItem -object $Network_Range_1_in_
DUT1__1_1_1_1_100_$my_ixDutConfigVirtual protocolPortRangeList.clearset my_ixDutPro-
tocolPortRange [::IxLoad new ixDutProtocolPortRange]$my_ixDutProtocolPortRange con-
fig \

-portRanges "1001,1002,1003-1006" \

-protocol "HTTP"
$my_ixDutConfigVirtual protocolPortRangeList.appendItem -object $my_ixDutPro-
tocolPortRangeset DUT1 [::IxLoad new ixDut]$DUT1 config \-comment
"" \-type "VirtualDut" \-name
"DUT1" \-dutConfig $my_ixDutConfigVirtual$DUT ele-
mentList.appendItem -object $DUT1
```

### SEE ALSO

[ixDut](#)

## ixDutNetworkRange

ixDutNetworkRange-Defines the one range of IP addresses (a subnet) that the Virtual DUT will have. Subnets defined here should match the subnets configured on the actual DUT.

### SYNOPSIS

```
set Network_Range_1_in_DUT1__1_1_1_1_100_ [::IxLoad new ixDutNet$Network_Range_1_in_
DUT1__1_1_1_1_100_ subcommand options...
```

### DESCRIPTION

Defines the one range of IP addresses (a subnet) that the Virtual DUT will have. Subnets defined here should match the subnets configured on the actual DUT.

The Range of IP addresses are added to the `ixRepository` object. For example,

```
set Network_Range_1_in_DUT1__1_1_1_1_100_ [::IxLoad new ixDutNetworkRange]$Network_
Range_1_in_DUT1__1_1_1_1_100_ config
```

### SUBCOMMANDS

The options for this command are configured and read using the standard `config`, `cget`, and `getOption` subcommands defined in the `ixConfig` command.

### OPTIONS

`vlanUniqueCount`

Specifies the number of VLAN IDs to create.

`firstIp`

This is the First IP address on the subnet, and subnet mask. Enter the subnet in /<bits> format, following the IP address.

For example, to specify an address of 198.162.0.1 with a subnet of 255.255.0.0, enter: 198.162.0.1/16 (Default = "1.1.1.1").

enable

If true this makes a subnet active. Only traffic from active subnets can be meshed meshed; inactive subnets are not used. Default = true.

name

Specifies the name of the Network Range.

vlanEnable

Enable this if the actual DUT uses VLANs. Default = false.

vlanId

Value of first 802.1Q VLAN tag.

ipIncrStep

Amount of increase in the IP address used to create additional IP addresses on the subnet, and octet that will be incremented. Default = "0.0.0.1".

networkMask

This specifies the subnet mask. Default = "255.255.0.0".

ipType

Specifies the type of addressing for the subnet: IPv4 or IPv6. IxLoad supports all forms of IPv6 addressing except ::dotted-quad notation (for example, "::1.2.3.4").

You must select the same type of addressing used on the corresponding subnet on the actual DUT. Default = 1.

vlanIncrStep

Amount of increase in the VLAN ID. IxLoad applies this value to the ID to create the complete list of VLAN IDs that will be meshed. Default = 1.

vlanCount

Number of VLAN IDs to create. Default = 1.

ipCount

Number of IP addresses on this subnet.

### EXAMPLE

```
set Network_Range_1_in_DUT1__1_1_1_1_100_ [::IxLoad new ixDutNetworkRange]$Network_
Range_1_in_DUT1__1_1_1_1_100_ config \-vlanUniqueCount 4094
```

```
\-firstIp                "1.1.1.1" \-enable
true \-name              "Network Range 1 in DUT1
(1.1.1.1+100)" \-vlanEnable      true \-vlanId
1 \-innerVlanEnable     false \-ipIncrStep
"0.0.0.1" \-networkMask      "255.255.0.0" \-ipType
1 \-vlanIncrStep        1 \-vlanCount
1 \-ipCount             100
```

## SEE ALSO

[ixDut](#)

[ixDutConfigVirtual](#)

## ixDutProtocolPortRange

ixDutProtocolPortRange-defines a protocol that the Virtual DUT listens for, and the ports that it listens of for that protocol.

### SYNOPSIS

```
set my_ixDutProtocolPortRange [::IxLoad new ixDutProtocolPortRange]
$my_ixDutProtocolPortRange subcommand options...
```

### DESCRIPTION

Defines a protocol that the Virtual DUT listens for, and the ports that it listens of for that protocol.

The ProtocolPortRange object is appended to the ixDutConfigVirtual object. For example, \$my\_ixDutConfigVirtual protocolPortRangeList.appendItem -object \$my\_ixDutProtocolPortRange

### SUBCOMMANDS

The options for this command are configured and read using the standard config, cget, and getOptions subcommands defined in the ixConfig command.

### OPTIONS

portRanges

Specifies the port numbers that the Virtual DUT listens on for the protocols in the protocol field.

protocol

Defines a protocol to listen for. A virtual dut supports the following protocols:

FTP	HTTP	IMAP	IPTV/Video
-----	------	------	------------



	LDAP	POP3	RADIUS	RTSP
	SMTP	SSH	DNS	All

**EXAMPLE**

```
set my_ixDutProtocolPortRange [::IxLoad new ixDutProtocolPortRange]$my_ixDutPro-
tocolPortRange config \-portRanges          "" \-protocol
"All"
```

**SEE ALSO**

[ixDut](#)

[ixDutConfigVirtual](#)

## ixDutConfigVip

ixDutConfigVip-DUT Configuration class for firewall and external server.

**SYNOPSIS**

```
set my_ixDutConfigVip [::IxLoad new ixDutConfigVip]
$my_ixDutConfigVip subcommand options...
```

**DESCRIPTION**

This class is associated with `ixDut` for DUT types - Firewall and External Server.

**SUBCOMMANDS**

The options for this command are configured and read using the standard `config`, `cget`, and `getOption` subcommands defined in the `ixConfig` command.

**OPTIONS**

`ipAddress`

Specifies the IP address used to access the DUT.

**EXAMPLE**

```
set my_ixDutConfigVip [::IxLoad new ixDutConfigVip]$my_ixDutConfigVip config \-
ipAddress          "1.1.1.1"
```

**SEE ALSO**

[ixDut](#)

## ixDutConfigSLB

ixDutConfigSLB-DUT Configuration class for server load balancer.

### SYNOPSIS

```
set my_ixDutConfigSLB [::IxLoad new ixDutConfigSLB]
$my_ixDutConfigSLB subcommand options...
```

### DESCRIPTION

This class is associated with `ixDut` for DUT types - Server Load Balancer.

### SUBCOMMANDS

The options for this command are configured and read using the standard `config`, `cget`, and `getOption` subcommands defined in the `ixConfig` command.

### OPTIONS

`enableDirectServerReturn`

Enables the Direct Server Run. In a topology using Direct Server Return, the responses are sent directly from the servers to the clients; they do not go through the SLB. Default = `false`.

`ipAddress`

Specifies the IP address used to access the DUT.

### SUB-OBJECTS

`serverNetwork`

If type is "Server Load Balancer (SLB)" and the SLB is balancing Ixia emulated servers, set this option to the server network that is being balanced. This must be an object of type `ixStatCatalogItem`. (Default = `{}`).

Note: Ixia Server Network is not supported in SLB options.

### EXAMPLE

```
set my_ixDutConfigSLB [::IxLoad new ixDutConfigSLB]$my_ixDutConfigSLB config \-
enableDirectServerReturn           false \-ipAddress
"198.18.0.101"
```

### SEE ALSO

[ixDut](#)

## ixView

ixViewOptions-Configures capture options.

### SYNOPSIS

```
set my_ixViewOptions [::IxLoad new ixViewOptions]$my_ixViewOptions config options...
```

### DESCRIPTION

The ixViewOptions command configures the capture (IxAnalyzer) options. Use the ixConfig sub-command to configure this command. It is added as an object instance to the captureViewOptions in ixTest.

### SUBCOMMANDS

The options for this command are configured and read using the standard config, cget, and getOptions subcommands defined in the ixConfig command.

### OPTIONS

runMode

Specifies when capture starts, and how long it continues for. Values are:

1	Automatic
2	Manual
3	Start capture after a delay of captureRunAfter time and capture for captureRunDuration.

captureRunDuration

If runMode type is 3, this parameter specifies the capture duration, in seconds.

captureRunAfter

If runMode type is 3, this parameter specifies the delay (after the test start) before capture begins. Specify the delay in seconds.

collectScheme

Specifies whether or not packets are displayed as they are captured during a test, and whether newer captured data overwrites older data, or not. This parameter combines the functions of two GUI parameters, Capture View Display Mode and Buffer Full Behavior, into a single Tcl command.

Values are:

0 (default)	Stream (real-time capture) + Stop Capture
1	Upload captured packet after capture stops + Stop Capture

2	Stream (real-time capture) + Overwrite oldest packets(circular buffer)
3	Upload captured packets after capture stops + Overwrite oldest packets(circular buffer)

allocatedBufferMemoryPercentage

Percentage of the available memory on the Ixia port allocated for capturing packets.

The memory available for capturing packets is the total amount of memory available on the port, less the amount required for the IxLoad test configuration. Of this remaining amount, you can reserve up to 70% for capturing packets.

### EXAMPLE

```
set my_ixViewOptions [::IxLoad new ixViewOptions]$my_ixViewOptions config \-runMode
1 \-captureRunDuration                0 \-captureRunAfter
0 \-collectScheme                      0 \-allocatedBufferMemoryPercentage
30set Test1 [::IxLoad new ixTest]$Test1 config \-comment
"" \-csvInterval                      4 \-name
"Test1" \-statsRequired                1 \-enableResetPorts
0 \-enableForceOwnership               false \-enableReleaseConfigAfterRun
0 \-captureViewOptions                 $my_ixViewOptions
```

### SEE ALSO

[ixTest](#)

## ixClientNetwork

ixClientNetwork-Defines a network for client agents.

### SYNOPSIS

```
set clientNetwork [::IxLoad new ixClientNetwork $chassisChain options]
$clientNetwork subsubcommandcommand options...
```

### DESCRIPTION

The `ixClientNetwork` command is used to construct a client network, which is used as part of an `ixClientTrafficNetworkMapping` object. A chassis chain object, as created in the `ixChassisChain` command, must be used in the construction of this object.

A list of network ranges, as defined in the `ixRepository` object is associated with the client network. Network ranges are added to the client network through the use of the `networkRangeList.appendItem` command.

A list of ports is also associated with the network through the `portList` option.

If an emulated router is to be used, a list of IP ranges for the router is also associated with the network through the `emulatedRouterIpAddressPool` option. The pool is defined in the `ixEmulatedRouterIpAddressRange` object. These are added to the object through the use of the `appendItem` command.

## SUBCOMMANDS

The options for this command are configured and read using the standard `config`, `cget`, and `getOption` subcommands defined in the `ixConfig` command. In addition the following commands are available. Unless otherwise described, no values are returned and an exception is raised for any error found.

### checkConfig

Checks the configuration of the client network object.

### reset

Disassociates the network from all of the Ixia ports currently in the `portList` option. Ownership of the ports is cleared.

## OPTIONS

`chassisChain`

This must be a chassis chain object, as created in the `ixChassisChain` command. It represents the set of chassis used in the test and defines the chassis IDs used in the `portList` component. This option should not be changed after `portList` is set. (Default = None).

`comment`

A commentary string for the object. (Default = "").

`emulatedRouterGateway`

If `macMappingMode` is set to `kMacMappingModePort`, then an emulated router is inserted between the clients and the external port. This is the gateway to be used for that router. (Default = 0.0.0.0).

`emulatedRouterGatewayIPv6`

If `macMappingMode` is set to `kMacMappingModePort` and `ipType` in `ixEmulat` is set to "IPv6" for any addresses, then an IPv6 address is also required for the emulated router inserted between the clients and the external port. This is the IPv6-format address of the gateway to be used for that router. IxLoad supports all forms of IPv6 addressing except `::dotted-quad` notation (for example, `:::1.2.3.4`). (Default = `:::C212:0001`).

`emulatedRouterSubnetIPv6`

Subnet mask applied to `emulatedRouterGatewayIPv6` address. (Default = `FFFF:FFFF:FFFF:FFFF:FFFF:FFFF::0`)

`emulatedRouterIpAddressPool`

If `macMappingMode` is set to `kMacMappingModePort`, then an emulated router is inserted between the clients and the external port. This option is a list of `ixEmulatedRouterIpAddressRange` objects which define the routers' source addresses that will be used. One IP address is taken from the list and used for each Ixia port. Refer to `ixConfigSequenceContainer` for a list of commands that may be used to manipulate this list. (Default = {})

`emulatedRouterSubnet`

If `macMappingMode` is set to `kMacMappingModePort`, then an emulated router is inserted between the clients and the external port. This is the network mask to be used for that router. (Default = 255.255.255.0).

`ipSourcePortFrom`

Defines the beginning of the range of ephemeral port numbers used to establish connections to the server. The end of the range is specified by `ipSourcePortTo`.

The first port in the range that IxLoad uses for traffic is 1 greater than the value you specify for `ipSourcePortFrom`. For example, if you specify 1,024, traffic originates from port 1025; no traffic originates from port 1,024. The minimum value for `ipSourcePortFrom` is 1024. (Default = 1,024).

`ipSourcePortTo`

Defines the end of the range of ephemeral port numbers used to establish connecto the server. The beginning of the range is specified by `ipSourcePortFrom`. (Default = 65,535).

`linkLayerOptions`

The link layer options to be associated with the ports associated with this client network. Only Ethernet options are currently supported. (Default = `kLink`)

`macMappingMode`

The mapping between IP addresses and MAC addresses. One of:

Option	Usage
<code>\$.ixClientNetwork(kMacMappingModeIp)</code>	(Default) One MAC address is associated with each IP address.
<code>\$.ixClientNetwork(kMacMappingModePort)</code>	One MAC address is used for all IP addresses on the port.

`name`

The name associated with this object. (Default = "newNetwork").

`networkRangeList`

A list of `ixRepository` objects that define the networks from which addresses will be associated with the clients. Refer to `ixConfigSequenceContainer` for a list of commands that may be used to manipulate this list. (Default = {}).

portList

A list of ports associated with the client network. Refer to `ixConfigSequenceContainer` for a list of commands that may be used to manipulate this list. Ports are added directly into this object; see the following example:

```
$clientNetwork portList.appendItem \  
-chassisId 1 \  
-cardId 2 \  
-portId 2
```

## SUB-OBJECTS

arpSettings

This is an object of type `ixArpSettings`, which specifies the manner in which ARP is handled on this network. (Default = <see `ixArpSettings`>). The options of this object should be set directly via: `$clientNetwork arpSettings.config options...`

dnsParameters

This is an object of type `ixDns`, which specifies the manner in which specifies the DNS operation associated with clients on this network. (Default = <see `ixDns`>). The options of this object should be set directly via:

```
$clientNetwork dnsParameters.config options...$clientNetwork dnsPara-  
meters.serverList.appendItem options...
```

tcpParameters

This is an object of type `ixTcpParameters` that specifies the manner in which TCP traffic is handled on this network. (Default = <see `ixTcpParameters`>). The options of this object should be set directly via:

```
$clientNetwork tcpParameters.config options...
```

## EXAMPLE

```
set clnt_network [::IxLoad new ixClientNetwork $chassisChain]$clnt_network config -  
name "clnt_network" \  
  
-cardType $::ixCard(kCard1000Txs4)  
-ipSourcePortFrom 1024 \  
-ipSourcePortTo 65536 \  
$clnt_network networkRangeList.appendItem \  
-enable 1 \  
-firstIp "198.18.2.1" \  
-networkMask "255.255.0.0" \  
-gateway "0.0.0.0" \  
-vlanEnable 0 \  
-vlanId -  
firstMac "00:C6:12:02:01:00" \  
1 \  
-mssEnable 0 \  
-mss 100  
  
$clnt_network portList.appendItem \  
-chassisId 1 \  
-cardId 2 \  
-portId 1
```

**SEE ALSO**[ixClientTrafficNetworkMapping](#)[ixChassisChain](#)[ixRepository](#)

## ixClientTraffic

ixClientTraffic-Builds a list of client agents to generate client traffic.

**SYNOPSIS**

```
set clientTraffic [::IxLoad new ixClientTraffic options]
```

```
$clientTraffic subcommand options...
```

**DESCRIPTION**

The `ixClientTraffic` command is used to construct the model for client traffic to be applied during a test. It is used in the `ixClientTrafficNetworkMapping` comto co-ordinate networks with client agent traffic. Its primary option is the `agentList` list of agents which will generate client traffic.

Agents are added to the `agentList` using the `appendItem` subcommand and may be otherwise manipulated using the commands supported by the `ixConfigSequenceContainer` command. All agents are added in the same manner:

```
set clientTraffic [::IxLoad new ixClientTraffic \  
  
-name "Traffic"]  
$clientTraffic agentList.appendItem \  
  
-name"my_protocol_traffic" \  
  
-protocol"<PROTOCOL>" \  
  
-type"Client" \  
<other per-protocol options>
```

The `name`, `protocol`, and `type` are required fields. These define a particular type of agent; the `protocol` field should be drawn from the table above. In addition to the required fields, the agent definition should include options which are specific to a particular protocol, and defined in their respective appendix.

**SUBCOMMANDS**

The options for this command are configured and read using the standard `config`, `cget`, and `getOption` subcommands defined in the `ixConfig` command. In addition, the following commands are avail-



able. Unless otherwise described, no values are returned and an exception is raised for any error found.

## checkConfig

Checks the configuration of the client traffic object.

## OPTIONS

name

The name associated with the agentList object. (Default = "newActivityModel").

agentList

A list of agent objects which define the agents that will be used to generate client traffic. Refer to the various appendixes listed above to determine the options that the agents offer. Refer to `ixConfigSequenceContainer` for a list of commands that may be used to manipulate this list. (Default = {}).

## EXAMPLE

```
#-----# Construct Client
Traffic#-----set clnt_
traffic [::IxLoad new ixClientTraffic \

-name "client_traffic"]

#-----# Create a HTTP cli-
ent agent#-----$clnt_
traffic agentList.appendItem \          -name          "my_http_client" \
-protocol          "HTTP" \          -type          "Client" \          -
maxSessions        3 \          -httpVersion        $::HTTP_Client(kHt-
tpVersion10) \          -keepAlive          0 \          -maxPersistentRequests 3 \
-followHttpRedirects 0 \          -enableCookieSupport 0 \          -
enableHttpProxy    0 \          -enableHttpsProxy 0 \          -
browserEmulation   $::HTTP_Client(kBrowserTypeIE5) \          -enableSsl
0          #-----
----# Add actions to this client agent#-----
-----foreach {pageObject destination} {          "/4k.htm" "svr_traffic_
my_http_server"          "/8k.htm" "svr_traffic_my_http_server"} {          $clnt_traffic
agentList(0).actionList.appendItem \          -command          "GET" \
-destination      $destination \          -pageObject      $pageObject      }
```

## SEE ALSO

`ixClientTrafficNetworkMapping` (see "[ixClientTrafficNetworkMapping](#)")

## ixClientTrafficNetworkMapping

ixClientTrafficNetworkMapping-Ties a client network to traffic model.

### SYNOPSIS

```
set clientMapping [::IxLoad new ixClientTrafficNetworkMapping options]
$clientMapping subcommand options...
```

### DESCRIPTION

The `ixClientTrafficNetworkMapping` command is used to map a set of agents that generate client traffic (in an `ixCustomPortMap` object) to the set of networks, which will carry the traffic (in an `ixDHCP` object).

A number of additional options control the manner in which the client traffic is applied to the networks.

The `objectiveType` and `objectValue` options allow the application of traffic to achieve a particular objective-for example, connections per second.

The `setObjectiveTypeForActivity` and `setObjectiveValueForActivity` options allow you set objectives and values for individual activities within a traffic-network mapping.

The `rampUpType`, `rampUpValue`, `rampDownTime`, `standbyTime`, `offlineTime`, `sustainTime`, and `totalTime` options determine the timeline for application of traffic.

`portMapPolicy` controls the manner in which client traffic is sent to servers.

### SUBCOMMANDS

The options for this command are configured and read using the standard `config`, `cget`, and `getOption` subcommands defined in the `ixConfig` command.

### OPTIONS

`enable`

If `true`, this mapping is included in the IxLoad test. (Default = `true`).

`getUserObjectiveTypeForActivity`

Objective type for user objective activity within a traffic-network mapping. You must specify the activity name. See the following example:

```
set objType [$clnt_t_n_mapping getUserObjectiveTypeForActivity("my_sip_client")]
```

`getUserObjectiveValueForActivity`

Objective type for user objective value within a traffic-network mapping. You must specify the activity name. See the following example:

```
set objValue [$clnt_t_n_mapping getUserObjectiveValueForActivity
```

```
iterations
```

The number of times that the traffic-network pair perform their functions (establishing TCP connections, retrieving FTP files, and so forth) in the test. (Default = 1) .

name

The name associated with this object. This is read-only and cannot be set from the API. (Default = "NetworkTrafficMapping") .

objectiveType

The objective to be achieved for this traffic to network mapping. One of:

Option	Usage
"N/A"	(Default) .
<code>::ixObjective(kObjectiveTypeSimulatedUsers)</code> or "simulatedUsers"	The objective is to simulate some number of users. If you select this objective, remember that a 'user' does not necessarily mean one human user. For example, a Web browser used by one person may open several connections to a Web site simultaneously; each connection counts as one 'user,' because each connection was initiated by the same source simultaneously. Specify the desired number of users in the <code>objectiveValue</code> option.
<code>::ixObjective(kObjectiveTypeConcurrentConnections)</code> or "concurrentConnections"	The objective is to sustain some number of connections simultaneously. Specify the desired number of connections in the <code>objectiveValue</code> option.
<code>::ixObjective(kObjectiveTypeConcurrentSessions)</code> or "concurrentSessions"	The objective is to sustain some number of sessions simultaneously. Specify the desired number of connections in the <code>objectiveValue</code> option.
<code>::ixObjective(kObjectiveTypeConnectionRate)</code> or "connectionRate"	The objective is to create connections at a certain rate. For example, if the traffic in this mapping is HTTP client traffic, this objective will attempt to generate the specified number of HTTP connections per second. Specify the desired number of connections per second in the <code>objectiveValue</code> option.
<code>::ixObjective(kObjectiveTypeThroughputMBps)</code> or "throughputMBps"	As of IxLoad 5.00, this option has been deprecated. Use <code>throughputMbps</code> instead.
<code>::ixObjective(kObjectiveTypeThroughputMbps)</code> or "throughputMbps"	The objective is to achieve a certain level of throughput, measured in megabits per second (Mbps). Specify the amount of throughput in the <code>objectiveValue</code> option.

<code>::ixObjective(kObjectiveTypeThroughputKBps)</code> or <code>"throughputKBps"</code>	As of IxLoad 5.00, this option has been deprecated. Use <code>throughputKbps</code> instead.
<code>::ixObjective(kObjectiveTypeThroughputKbps)</code> or <code>"throughputKbps"</code>	The objective is to achieve a certain level of throughput, measured in kilobits per second (Kbps). Specify the amount of throughput in the <code>objectiveValue</code> option.
<code>::ixObjective(kObjectiveTypeThroughputGbps)</code> or <code>"throughputGbps"</code>	The objective is to achieve a certain level of throughput, measured in gigabits per second (Kbps). Specify the amount of throughput in the <code>objectiveValue</code> option.
<code>::ixObjective(kObjectiveTypeTransactionRate)</code> or <code>"transactionRate"</code>	The objective is to complete transactions at a certain rate. For example, if the traffic in this mapping is HTTP client traffic, this objective will attempt to complete the specified number of transaction per second. The definition of what constitutes one complete HTTP transaction depends on whether you select HTTP 1.0 or 1.1: HTTP 1.0: open socket - issue GET - GET response - close socket. HTTP 1.1: Open socket (if closed) - send request - Get response. Specify the desired number of transactions per second in the <code>objectiveValue</code> option.

`objectiveValue`

Value for the choice made in the `objectiveType` option.

`objectiveConstraints`

Currently, constraints can be set on activities that run rate-based objectives, like `connectionRate`, `transactionRate`, `throughput` objectives.

The following API can be used to set the constraint value. The constraint needs to be enabled on the activity.

```
$clnt_t_n_mapping setconstraints "my_http_client" 200 true
```

This sets the constraint value to 200 and `true` enables the constraint. If the activity is running a rate based activity, then the number of simulated users will be limto 200.

```
$clnt_t_n_mapping setconstraints "my_http_client" 200 false
```

This sets the constraint value to 200 and `false` does not enable the constraint. The number of simulated users will not be limited here.

`offlineTime`

The amount of time agents are idle between iterations. (Default = 0).

`portMapPolicy`

This option controls the sequence in which the client ports connect to the server ports. One of:

Option	Usage
<code>\$.ixPortMap</code> ( <code>kPortMapRoundRobin</code> ) or <code>"portPairs"</code>	(Default) . Client agents connect to server agents on a one-to-one basis.
<code>\$.ixPortMap</code> ( <code>kPortMapFullMesh</code> ) or <code>"portMesh"</code>	Agents on every client port connect to every server port.
<code>\$.ixPortMap</code> ( <code>kPortMapIpPair</code> ) or <code>"ipPair"</code>	Each simulated user on the client side communicates with only one server IP address. This choice is only valid for SIP agents.
<code>\$.ixPortMap</code> ( <code>kPortMapCustom</code> ) or <code>"custom"</code>	Each custom port map has a list of IPv4 submap and IPv6 submaps. You can create a Custom traffic map. In a Custom traffic map, you select the client and server IP address ranges that will send traffic to each other. To create a Custom traffic map, the subnet's <code>rangeType</code> parameter must be set to <code>IP Only</code> (Ethernet).

For large numbers of ports, the Port Pair sequence scales performance better than the Port Mesh sequence.

The operation of Port Pairs can be described by three scenarios:

- If the number of client ports is equal to the number of server agents, client ports will establish connections to server ports on a one-to-one basis.
- If the number of client ports is less than the number of server ports, the client ports will establish connections to the server ports on a one-to-one basis until all client ports are paired with server ports. The remaining server ports will not be used.
- If the number of client ports is greater than the number of server ports, the client ports will establish connections to the server ports on a one-to-one basis until all server ports are paired with client ports. Then, the remaining client ports will return to the first server port and continue pairing themselves with server ports.

The `ixCustomPortMap` customizes the order and frequency, by which client IPs will access server IPs.

Each custom port map has a list of IPv4 submaps and IPv6 submaps. There will be a list for the appropriate IP type if any ranges of that type appear in the network for the symbolic destination. When a submap list is initialized, it will have a single submap that will be a full IP mesh, if that type is available. If only vLAN maps are allowed, then it will be a VLAN pairs map instead. If a submap is appended to the list, by default it will be a copy of the last submap in the list, unless values are passed in.

`rampDownTime`

The amount of time used for closing any TCP connections that are still open after all transactions are complete. When the ramp downtime expires, IxLoad terminates any remaining users.

If IxLoad terminates any client users that are still running after the ramp down expires, statistics for servers and clients that should match may not. This is an indication that the ramp downtime may be too short. (Default = 20).

rampUpTime

(Read-only) . The amount of time that the test will spend bringing users online and initiating their first TCP connections. IxLoad calculates this time based on the number of users and the `rampUpType` option.

rampUpType

The method used to apply the `rampUpValue`. One of:

Option	Usage
<code>\$.ixTimeline (kRampUpType UsersPerSecond)</code>	(Default) . IxLoad applies the <code>rampUpValue</code> to bring up the specified number of users per second. For example, if you select <code>Users/Second</code> and you specify 10 for the <code>rampUpValue</code> , IxLoad brings up 10 new users every second until all the users are up and running.
<code>\$.ixTimeline (kRampUpType MaxPendingUsers)</code>	IxLoad applies the <code>rampUpValue</code> to maintain a pool of users waiting to create connections. Regardless of how quickly the servers complete connections, IxLoad will always be ready with one or more new clients waiting to connect. As each user successfully creates a connection, IxLoad adds a new user to the pending pool until all the users are up and running. For example, if you select <code>Max. Pending Users</code> and you specify 10 for the <code>rampUpValue</code> , IxLoad maintains 10 users waiting to establish connections until all the users are up and running.

rampUpValue

A value dependent on the setting of `rampUpType`. One of:

Option	Usage
<code>\$.ixTimeline(kRampUpType UsersPerSecond)</code>	The specified number of users per second to bring up.
<code>\$.ixTimeline(kRampUpType MaxPendingUsers)</code>	The size of the pool of pending users awaiting con

rampUpInterval

This field accepts integer values. The value for this option will be considered only when `rampUpType` is `usersPerSecond`. You can edit the value to increment or decrement the number of users to be started at every `rampUpInterval`. (Default = 1).

```
#-----# Create a client and
server mapping and bind into the# network and traffic that they will be employing#--
-----set clnt_t_n_mapping
[::IxLoad new ixClientTrafficNetworkMapping \      -network          $clnt_net-
work \      -traffic          $clnt_traffic \      -objectiveType          $::ixOb-
jective(kObjectiveTypeSimulatedUsers) \      -objectiveValue          20 \      -
rampUpValue          5 \      -rampUpInterval          10 \      -sustainTime
20 \      -rampDownTime          20
```

In this example, 5 simulated users will be started every 10 seconds until the configured total number of simulated users are started.

```
setObjectiveTypeForActivity
```

Objective type for a single activity within a traffic-network mapping. You must specify the activity and the objective type. The objectives available are the same as for `objectiveType`. See the following example:

```
setObjectiveTypeForActivity "my_http_client" \ $::ixObjective(kOb-
jectiveTypeConnectionRate)
```

```
setObjectiveValueForActivity
```

Objective value for a single activity within a traffic-network mapping. You need to specify the activity and the value. See the following example:

```
setObjectiveTypeForActivity setObjectiveValueForActivity \ "my_http_client" 200
```

```
setPortMapForActivity
```

Port mapping for a single activity within a traffic-network mapping. You need to specify the activity and the `portMapPolicy`. See the following example:

```
setObjectiveTypeForActivitsetPortMapForActivity \ "my_http_client" $::ixPortMap
(kPortMapFullMesh)
```

```
setUserObjectiveTypeForActivity
```

Objective type for user objective activity within a traffic-network mapping. You need to specify the activity name and the `userObjectiveType`. See the following example:

```
$clnt_t_n_mapping setUserObjectiveTypeForActivity("my_sip_client", "bhca")
```

```
setUserObjectiveValueForActivity
```

Objective type for user objective value within a traffic-network mapping. You need to specify the activity name and the `userObjectiveType`. See the following example:

```
$clnt_t_n_mapping setUserObjectiveValueForActivity("my_sip_client", 3600)
```

```
standbyTime
```

The amount of time, expressed in seconds, that elapses between the time the test is started and the time that the traffic-network pair become active. If you have multiple traffic-network pairs in your test,

you can use this parameter to stagger their start times. A value of 0 causes the test to begin immediately. The valid range is from 0 to 1,000 hours (3,600,000). (Default = 0).

sustainTime

The amount of time, in seconds, when all users are up and performing the central test objectives, such as establishing and closing connections (TCP), retrieving or serving pages (HTTP), or sending or receiving files (FTP). The valid range is from 0 to 1,000 hours (3,600,000). (Default = 20).

totalTime

The total time required to run the test, including Ramp Up, Ramp Down, Sustain, and Offline times for all iterations. (Default = 60).

userObjectiveType

UserObjectivetypes are basically alternate representations of the basic objectiveType - simulatedUsers, transactionRate, concurrentSessions, concurconnectionsPerSecond, throughputMbps, throughputKbps. They can have a scaling factor associated with them. For example, bhca has a scaling factor of 3,600. This means that, 3,600 busy hour call attempts (BHCA) userOb represents 1 transactionRate objectiveValue.

userAgents represents simulatedUsers with scaling factor of 1.

callsPerSec represents transactionRate with scaling factor of 1.

Registrationsinitiated represents transactionRate with scaling factor of 1.

Redirectionsinitiated also represents transactionRate with scaling factor of 1.

```
set clnt_t_n_mapping [::IxLoad new ixClientTrafficNetworkMapping \
```

```
-network          $clnt_network \-traffic          $clnt_traffic \-
standbyTime       30 \-userObjectiveType          "bhca" \-userObjectiveValue
3600 \-rampUpValue      1 \-sustainTime          40 \-rampDownTime
20
```

Option	Usage
userAgents"	The objective is to sustain some number of SIP calls simultaneously. Specify the desired number of UserAgents in the objectiveValue option.
callsPerSecond	The objective is to establish a certain number of SIP calls per second. Specify the desired number of calls to establish per second in the objectiveValue option.



bhca	The objective is to establish a certain number of SIP calls per hour. Specify the desired number of calls to establish per hour in the objectiveValue option. Busy hour call attempts (BHCA) is a standard measure of the number of calls completed during a busy hour, the 60-minute period when the maximum traffic load occurs within a given 24-hour period.
registrationsinitiated	The objective is to establish a certain number of call registrations of SIP. Specify the desired number of registrations in the objectiveValue option.
redirectionsinitiated	The objective is to establish a certain number of call redirections of SIP. Specify the desired number of redirections in the objectiveValue option.
transactionAttemptRate	The objective is to issue some number of DNS query per second. The number of DNS query is mentioned in the userObjectiveValue option.
connectionAttemptRate	The objective is achieved if IxLoad succeeds in making the specified number of attempts to connect to the HTTP server or DUT. Specify the desired number of attempted connections per second in the userObjectiveValue option.

userObjectiveValue

A value related to the choice made in the userObjectiveType option. One of:

Option	Usage
Calls	The desired number of calls.
Callspersecond	The desired number of calls to establish per second.
Bhca	The desired number of calls to establish per hour.
Useragents	The desired number of user agents to be simulated.
Registrationinitiated	The desired number of registrations to be initiated during the test.
Redirectionsinitiated	The desired number of call redirections initiated during the test.
Queriespersecond	The desired number of DNS query per second.

## SUB-OBJECTS

network

An object instance of type `ixDHCP`, which provides the networks from which the traffic will be generated. (Default = {}).

traffic

An object of type `ixCustomPortMap`, which provides the model of traffic to be generated. (Default = {}).

### EXAMPLE

```
#-----# Create the client
traffic to network mapping#-----
-----set clnt_mapping [::IxLoad new ixClientTrafficNetworkMapping \ -network
$clnt_network \ -traffic $clnt_traffic \ -objectiveType $::ixOb-
jective(kObjectiveTypeSimulatedUsers)\ -objectiveValue 20 \ -
rampUpValue 5 \ -sustainTime 20 \ -rampDownTime
20]
```

### SEE ALSO

[ixTest](#)

[ixCustomPortMap](#)

## ixNetworkRange

`ixNetworkRange`-Defines a range of IP and MAC addresses.

Note: This item has been deprecated.

### SYNOPSIS

```
set networkRange [::IxLoad new ixNetworkRange options]
```

```
$networkRange subcommand options...
```

### DESCRIPTION

The `ixNetworkRange` command is used to construct a network range consisting of a set of IP, MAC, and vLAN addresses. This is used in the `ixDHCP` and `ixStatCatalogItem` commands. If the `ixDHCP/ixStatCatalogItem` command specifies "MACPerPort" mapping mode in its `macMappingMode` option, then the `gateway`, `firstMac`, and `macIncrStep` options are not relevant; all network ranges route to the emulated router and a single MAC addresses emanates from each Ixia port.

### SUBCOMMANDS

The options for this command are configured and read using the standard `config`, `cget`, and `getOption` subcommands defined in the `ixConfig` command. In addition, the following commands are available. Unless otherwise described, no value returned and an exception is raised for any error found.

`checkConfig`

Checks the configuration of the client network object.

```
set range
```

Helps to select the activities (protocol agents) that each networkRange will run.

```
set range1 [$clnt_network networkRangeList.getItem 0]$clnt_t_n_mapping setActiv-
ityAvailableForRange $range1 "my_http_client" true;set isAvailable [$clnt_t_n_mapping
isActivityAvailableForRange $range1 "my_http_client"];puts "======" Activity-IP Map-
ping for Http Agent "======"puts $isAvailable
```

## OPTIONS

```
enable
```

If true, enables the use of this network range. (Default = true).

```
enableStats
```

This is enabled to value 1, to collect per interface statistics ( - AddPerInterfaceStat arguments). (Default = 0).

```
firstIp
```

The first IP address for the range. If ipType is set to "IPv4," this must be an IPv4 address. If ipType is set to "IPv6," this must be an IPv6 address. Only HTTP and FTP agents support IPv6 addressing. If there is a mixture of IPv4 and IPv6 addresses, other protocols will use only the IPv4 addresses. IxLoad supports all forms of IPv6 addressing except ::dotted-quad notation (for example, "::1.2.3.4"). (Default = 198.18.0.1).

```
firstMac
```

The first MAC address for the range. This is not used if the value of macMin in the containing ixDHCP/ixStatCatalogItem object is set to "MACPerPort." (Default = 00:C6:12:00:01:00).

```
gateway
```

The gateway associated with all IP addresses in the network range. (Default = 0.0.0.0).

```
ipCount
```

The number of unique IP addresses in the network range. (Default = 100).

```
ipIncrStep
```

Indicates the increment to be applied between generated IP addresses. The format of this option is a dotted-quad IP address, in which only one of the octets may be nonzero. For example, 0.0.0.1, 0.0.2.0, 0.22.0.0 and 4.0.0.0 are valid values which will increment a different octet each time. Values that use more than one octet, for example 0.0.1.1, are illegal. (Default = 0.0.0.1). Some useful constants are:

Constant	Value
ixNetworkRange(kIpIncrOctetFirst)	1.0.0.0

<code>\$.ixNetworkRange(kIpIncrOctetSecond)</code>	0.1.0.0
<code>\$.ixNetworkRange(kIpIncrOctetThird)</code>	0.0.1.0
<code>\$.ixNetworkRange(kIpIncrOctetForth)</code>	0.0.0.1

#### ipType

Type of IP address. This parameter indicates whether the address range is a range of IPv4 addresses or a range of IPv6 addresses. Only HTTP and FTP agents supIPv6. If there is a mixture of IPv4 and IPv6 addresses, other protocols will use only IPv4 addresses. IxLoad supports all forms of IPv6 addressing except `::dotted-quad` notation (for example, `:::1.2.3.4`). The choices are: "IPv4" and "IPv6." (Default = "IPv4").

#### macIncrStep

Indicates the increment to be applied between generated MAC addresses. The format of this option is a colon separated MAC address, in which only one of the octets may be nonzero. For example, `00:00:00:00:00:01`, `00:00:00:00:22:00`, `00:00:00:33:00:00`, `00:00:44:00:00:00`, `00:AA:00:00:00:00`, and `C:00:00:00:00:00` are valid values that will increment a different octet each time. Values that use more than one octet, for example `00:00:00:00:01:01`, are illegal. This is not used if the value of `macMappingMode` in the containing `ixDHCP/ixStatCatalogItem` object is set to "MACPerPort." (Default = `00:00:00:00:00:01`). Some useful constants are:

Constant	Value
<code>\$.ixNetworkRange(kMacIncrOctetFirst)</code>	01:00:00:00:00:00
<code>\$.ixNetworkRange(kMacIncrOctetSecond)</code>	00:01:00:00:00:00
<code>\$.ixNetworkRange(kMacIncrOctetThird)</code>	00:00:01:00:00:00
<code>\$.ixNetworkRange(kMacIncrOctetForth)</code>	00:00:00:01:00:00
<code>\$.ixNetworkRange(kMacIncrOctetFifth)</code>	00:00:00:00:01:00
<code>\$.ixNetworkRange(kMacIncrOctetSixth)</code>	00:00:00:00:00:01

#### mss

If `mssEnable` is `true`, this option specifies the TCP Maximum Segment Size in the MSS (RX) field. Otherwise, IxLoad clients or servers advertise their TCP MaxiSegment Size as 1,460 bytes. (Default = 1,460).

#### mssEnable

If `true`, the use of the `mss` option is enabled. (Default = `false`).

#### networkMask

The subnet mask associated with the IP range. (Default = 255.255.0.0).

rangeType

Type of IP range configured on the subnet.

Value
Ethernet (default)
DHCP
IPSec
PPPoE
DHCP-PD
DHCP-PD Client

vlanEnable

If true, vLAN IDs are inserted.

vlanId

If vlanEnable is true, this is the vLAN ID used. (Default = None).

### EXAMPLE

See example in `ixDHCP`.

### SEE ALSO

[ixStatCatalogItem](#)

## ixServerNetwork

ixServerNetwork-Defines a network for server agents.

### SYNOPSIS

```
set serverNetwork [::IxLoad new ixServerNetwork $chassisChain options]
$serverNetwork subcommand options...
```

## DESCRIPTION

The `ixServerNetwork` command is used to construct a server network, which is used as part of an `ixServerTrafficNetworkMapping` object. A chassis chain object, as created in the `ixChassisChain` command, must be used in the construction of this object.

A list of network ranges, as defined in the `ixRepository` object is associated with the server network. Network ranges are added to the server network through the use of the `networkRangeList.appendItem` command.

A list of ports is also associated with the network through the `portList` option.

If an emulated router is to be used, a list of IP ranges for the router is also associated with the network through the `emulatedRouterIpAddressPool` option. These are added to the object through the use of the `emulatedRouterIpAddressPool.appendItem` command.

## SUBCOMMANDS

The options for this command are configured and read using the standard `config`, `cget`, and `getOption` subcommands defined in the `ixConfig` command. In addition the following commands are available. Unless otherwise described, no values are returned and an exception is raised for any error found.

### checkConfig

Checks the configuration of the server network object.

### reset

Disassociates the network group from all of the Ixia ports currently in the `portList` option. Ownership of the ports is cleared.

## OPTIONS

`chassisChain`

This must be a chassis chain object, as created in the `ixChassisChain` command. It represents the set of chassis used in the test and defines the chassis IDs used in the `portList` component. This option should not be changed after `portList` is set. (Default = None).

`comment`

A commentary string for the object. (Default = "").

`emulatedRouterGateway`

If `macMappingMode` is set to `kMacMappingModePort`, then an emulated router is inserted between the servers and the external port. This is the gateway to be used for that router. (Default = 0.0.0.0).

`emulatedRouterIpAddressPool`

If `macMappingMode` is set to `kMacMappingModePort`, then an emulated router is inserted between the servers and the external port. This option is a list of `ixEmulatedRouterIpAddressRange` objects that

define the routers' source addresses that will be used. One IP address is taken from the list and used for each Ixia port. Refer to `ixConfigSequenceContainer` for a list of commands that may be used to manipulate this list. (Default = {}).

`emulatedRouterSubnet`

If `macMappingMode` is set to `kMacMappingModePort`, then an emulated router is inserted between the clients and the external port. This is the network mask to be used for that router. (Default = 255.255.255.0).

`emulatedRouterGatewayIPv6`

If `macMappingMode` is set to `kMacMappingModePort` and `ipType` in `ixEmulatedRouterIpAddressRange` is set to "IPv6" for any addresses, then an IPv6 address is also required for the emulated router inserted between the clients and the external port. IxLoad supports all forms of IPv6 addressing **except** ::dotted-quad notation (for example, "::1.2.3.4"). This is the IPv6-format address of the gateway to be used for that router. (Default = "::C212:0001").

`emulatedRouterSubnetIPv6`

Subnet mask applied to `emulatedRouterGatewayIPv6` address. (Default = "FFFF:FFFF:FFFF:FFFF:FFFF:FFFF::0").

`impairment`

If enabled, this option helps to intentionally degrade the traffic transmitted by the network. You can cause it to drop or duplicate packets, or delay them for certain lengths of time. Refer to `ixImpairment` for a description of all the options.

`ipSourcePortFrom`

Defines the beginning of the range of ephemeral port numbers used to establish connections. The end of the range is specified by `ipSourcePortTo`.

The first port in the range that IxLoad uses for traffic is 1 greater than the value you specify for `ipSourcePortFrom`. For example, if you specify 1,024, traffic originates from port 1,025; no traffic originates from port 1,024. The minimum value for `ipSourcePortFrom` is 1,024. (Default = 1,024).

`ipSourcePortTo`

Defines the end of the range of ephemeral port numbers used to establish connection to the server. The beginning of the range is specified by `ipSourcePortFrom`. (Default = 65,535).

`linkLayerOptions`

The link layer options to be associated with the ports associated with this server network. Only Ethernet options are currently supported. (Default = `kLink`

`macMappingMode`

The mapping between IP addresses and MAC addresses. One of:

Option	Usage
--------	-------

<code>::ixServerNetwork(kMacMappingModeIp)</code>	(Default) One MAC address is associated with each IP address.
<code>::ixServerNetwork(kMacMappingModePort)</code>	One MAC address is used for all IP addresses on the port.

`name`

The name associated with this object. (Default = "newNetwork").

`networkRangeList`

A list of `ixRepository` objects that define the networks from which addresses will be associated with the servers. Refer to `ixConfigSequenceContainer` for a list of commands that may be used to manipulate this list. (Default = {}).

`portList`

A list of ports associated with the server network. Refer to `ixConfigSequenceContainer` for a list of commands that may be used to manipulate this list. Ports are added directly into this object; see the following example:

```
$serverNetwork portList.appendItem \
-chassisId 1 \
-cardId 2 \
-portId 2
```

`rangeType`

Type of IP range configured on the subnet.

Value
Ethernet (default)
DHCP
IPSec
PPPoE
DHCP-PD
DHCP-PD Client

You can insert the same parameters for the `ixStatCatalogItem`.

## SUB-OBJECTS

`arpSettings`



This is an object of type `ixArpSettings`, which specifies the manner in which ARP is handled on this network. (Default = <see `ixArpSettings`>). The options of this object should be set directly via: `$serverNetwork arpSettings.config options...`

`tcpParameters`

This is an object of type `ixTcpParameters` that specifies the manner in which TCP traffic is handled on this network. (Default = <see `ixTcpParameters`>). The options of this object should be set directly via:

`$serverNetwork tcpParameters.config options...`

### EXAMPLE

```
set svr_network [::IxLoad new ixServerNetwork $chassisChain]$svr_network config -
name "svr_network" \

-cardType $::ixCard(kCard1000Txs4)
-ipSourcePortFrom 1024 \
-ipSourcePortTo 65536 \
$svr_network networkRangeList.appendItem \           -name           "svr_range" \
-enable           1 \           -firstIp           "198.18.200.1" \           -ipCount           1
\           -networkMask           "255.255.0.0" \           -gateway           "0.0.0.0" \           -
firstMac           "00:C6:12:02:02:00" \           -vlanEnable           0 \           -vlanId
1 \           -mssEnable           0 \           -mss           100

$svr_network impairment.config\           -enable           True\           -addDrop           True\           -drop           5

$svr_network portList.appendItem \           -chassisId           1 \           -cardId           2 \
-portId           2
```

### SEE ALSO

`ixClientTrafficNetworkMapping` (see [ixClientTrafficNetworkMapping](#)),

`ixChassisChain` (see [ixChassisChain](#)),

`ixRepository` (see [ixRepository](#))

## ixServerTraffic

`ixServerTraffic`-Builds a list of server agents to handle server traffic.

### SYNOPSIS

```
set serverTraffic [::IxLoad new ixServerTraffic options]
$serverTraffic subcommand options...
```

## DESCRIPTION

The `ixServerTraffic` command is used to construct the model for server network traffic to be handled during a test. It is used in the `ixServerTrafficNetworkMapping` command to co-ordinate networks with server agents.

Its primary option is the `agentList` list of agents that will handle server traffic. The agents that exist for a number of protocols are documented in the subsequent chapters.

Agents are added to the agent list using the `appendItem` subcommand and may be otherwise manipulated using the commands supported by the `ixConfigSequenceContainer` command. All agents are added in the same manner:

```
set serverTraffic [::IxLoad new ixServerTraffic \  
  
-name "Servers"]  
$serverTraffic agentList.appendItem \  
  
-name"my_protocol_server" \  
  
-protocol"<PROTOCOL>" \  
  
-type"Server" \  
<other per-protocol options>
```

The `name`, `protocol`, and `type` are required fields. These define a particular type of agent; the `protocol` field should be drawn from the table above. In addition to the required fields, the agent definition should include options that are specific to a particular protocol, and defined in their respective appendix.

## SUBCOMMANDS

The options for this command are configured and read using the standard `config`, `cget`, and `getOption` subcommands defined in the `ixConfig` command. In addition, the following commands are available. Unless otherwise described, no values are returned and an exception is raised for any error found.

### checkConfig

Checks the configuration of the server traffic object.

## OPTIONS

`agentList`

A list of agent objects that define the agents, which will be used to handle server traffic. Refer to the various appendixes listed above to determine the options that the agents offer. Refer to `ixConfigSequenceContainer` for a list of commands that may be used to manipulate this list. (Default = {}).

`name`

The name associated with this object. (Default = "newActivityModel").

**EXAMPLE**

```
#-----# Construct the Server
Traffic#-----set svr_traffic
[::IxLoad new ixServerTraffic \
-name "svr_traffic"
  #-----# Create a server
agent -- no actions are involved in this agent#-----
-----$svr_traffic agentList.appendItem \      -name      "my_
http_server" \      -protocol  "HTTP" \      -type      "Server" \      -
httpPort  80for {set idx 0} {$idx < \

  [$svr_traffic agentList(0).responseHeaderList.indexCount]}\
  {incr idx} {

    set response [$svr_traffic \
agentList(0).responseHeaderList.getItem $idx]
    if {[$response cget -name] == "200_OK"} {      set response200ok $response
}    if {[$response cget -name] == "404_PageNotFound"} {      set response404_
PageNotFound $response      }}

#-----# Clear pre-defined
web pages, add new web pages#-----
-----$svr_traffic agentList(0).webPageList.clear  $svr_traffic agentList
(0).webPageList.appendItem \      -page      "/4k.html" \      -payloadType
"range" \      -payloadSize  "4096-4096" \      -response      $response200ok

$svr_traffic agentList(0).webPageList.appendItem \      -page      "/8k.html"
\      -payloadType  "range" \      -payloadSize  "8192-8192" \      -
response      $response404_PageNotFound
```

**SEE ALSO**

[ixServerTrafficNetworkMapping](#)

## ixServerTrafficNetworkMapping

ixServerTrafficNetworkMapping-Ties a server network to traffic model.

**SYNOPSIS**

```
set serverMapping [::IxLoad new ixServerTrafficNetworkMapping options]
$serverMapping subcommand options...
```

## DESCRIPTION

The `ixServerTrafficNetworkMapping` command is used to map a set of server agents that receive traffic (in an `ixServerTraffic` object) to the set of networks that will carry the traffic (in an `ixStatCatalogItem` object).

A number of additional options control the manner in which the server traffic applied to the networks.

The `standbyTime`, `offlineTime`, `sustainTime`, and `totalTime` options determine the timeline for server agents.

## SUBCOMMANDS

The options for this command are configured and read using the standard `config`, `cget`, and `getOption` subcommands defined in the `ixConfig` command.

## OPTIONS

`enable`

If `true`, this mapping is included in the IxLoad test. (Default = `true`).

`iterations`

The number of times that the traffic-network pair perform their functions (establishing TCP connections, retrieving FTP files, and so forth) in the test. (Default = 1).

`matchClientTotalTime`

If `true`, the servers on this mapping will stay online for the same length of time as the longest-running client agent.

If you do not check this box and a server's duration is shorter than one of the clients connecting to it, the server will go offline while the client is connected; if this is not what you intend to happen during testing, the test results for that client may be misleading.

If `false`, IxLoad calculates agent run times independently for each server activity. (Default = `true`).

`name`

The name associated with this object. (Default = `"NetworkTrafficMapping"`).

`offlineTime`

Amount of time agents are idle between iterations. (Default = 0).

`standbyTime`

The amount of time, expressed in seconds, that elapses between the time the test is started and the time that the traffic-network pair become active. If you have multiple traffic-network pairs in your test, you can use this parameter to stagger their start times. A value of 0 causes the test to begin immediately. The valid range is from 0 to 1,000 hours (3,600,000). (Default = 0).

`sustainTime`

The amount of time, in seconds, during which all users are up and performing the central test objectives, such as establishing and closing connections (TCP), retrieving or serving pages (HTTP), or sending or receiving files (FTP). (Default = 20).

totalTime

The total time required to run the test, including Standby, Sustain, and Offline times for all iterations. (Default = 60).

## SUB-OBJECTS

network

An object of type `ixStatCatalogItem` that provides the networks associated with the server agents. (Default = {}).

traffic

An object of type `ixServerTraffic` that provides the model of traffic to be generated. (Default = {}).

## EXAMPLE

```
#-----# Create the server
traffic to network mapping#-----
----set svr_mapping [::IxLoad new ixServerTrafficNetworkMapping \      -network
$svr_network \      -traffic      $svr_traffic \      -
matchClientTotalTime 1]
```

## SEE ALSO

[ixTest](#)

[ixStatCatalogItem](#)

[ixServerTraffic](#)

## ixWaitEventCommand

`ixWaitEventCommand` - cause a command to wait for another to execute

### SYNOPSIS

```
$my_ixWaitEventCommand config \
-optionvalue
```

## DESCRIPTION

`ixWaitEventCommand` causes one command to wait for another to finish executing for it is itself executed. `ixSendEventCommand` is used to trigger the waiting command. `ixSendEventCommand` and `ixWaitEventCommand` are added to an `actionList` using the `appendItem` command.

For example, if `Command2` must be executed only after `Command1` has been executed:

1. An `ixWaitEventCommand` is inserted preceding `Command2`.
2. An `ixSendEventCommand` is added after `Command1`, with the same `eventID` as in the `ixWaitEventCommand`.

When `Command1` finishes executing, the `ixSendEventCommand` ends the `ixWaitEventCommand` for `Command2`, causing `Command2` to be executed.

`ixSendEventCommand` and `ixWaitEventCommand` can only be used with Subscriber activities.

## OPTIONS

`commandType`

Command type. The only value is "WaitEventCommand".

`eventID`

Unique value identifying this `ixWaitEventCommand`. Default value = 1.

## EXAMPLE

```
set my_ixSendEventCommand [::IxLoad new ixSendEventCommand]
my_ixSendEventCommand config \
-commandType"SendEventCommand" \
-eventId1

$Subscriber_Activity_HTTPClient1 agent.actionList.appendItem -object $my_ixSendEventCommand
.
.
.
$Subscriber_Activity_FTPClient1 agent.actionList.clear

set my_ixWaitEventCommand [::IxLoad new ixWaitEventCommand]
```

```
$my_ixWaitEventCommand config \  
-commandType"WaitEventCommand" \  
-eventId1
```

```
$Subscriber_Activity_FTPClient1 agent.actionList.appendItem -object $my_ixWaitEventCommand
```

## **SEE ALSO**

[ixSendEventCommand](#)

! 5

This page intentionally left blank.



## Internal Commands

This section lists the IxLoad Tcl API's internal commands.

### duplicate

duplicate—Copy elements from one object to another.

#### SYNOPSIS

```
set <target network/traffic/dut> [${<source network/traffic/dut> duplicate}]
```

#### DESCRIPTION

Enables a NetTraffic to use a copy of a component used in another NetTraffic. You can duplicate networks, traffics, and DUTs. The example shows Traffic3 using copies of the same activities (agents) as Traffic1.

#### SUBCOMMANDS

None

#### OPTIONS

None.

#### EXAMPLE

```
set Traffic1 [${Traffic1_Network1 cget -traffic}]
set Traffic3 [${Traffic1 duplicate}]
${Traffic1_Network3 config \
-traffic ${Traffic3}
```

### ixConfig

ixConfig—Allows options to be configured for an object.

## SYNOPSIS

```
set anyIxLoadObject [$::IxLoad new ixLoadObject options]  
$anyIxLoadObject subcommand options...
```

## DESCRIPTION

The `ixConfig` object provides the means by which command options are set and read. It is never used directly. The commands that are based on `ixConfig` support the subcommands described below.

## SUBCOMMANDS

The following subcommands are available to handle options:

### **cget** option

This subcommand is used to obtain the current value of any option. The `option` must begin with a hyphen (-). The return value is of a type appropriate for the option.

### **config** option value option value...

The `config` subcommand may be used to set the value of one or more options in a command. The `option` must begin with a hyphen (-). The `value` must be of a type appropriate for the option.

### **getOptions**

This subcommand returns a Tcl list with all of the options available for a community including an initial hyphen for each option.

## OPTIONS

None.

## EXAMPLE

```
$object cget -name$object config -name "media" -value "mp3"  
set optionList [$object getOptions]
```

## ixConfigSequenceContainer

`ixConfigSequenceContainer`—Handles a list of objects.

## SYNOPSIS

```
set anyIxLoadObject [$::IxLoad new ixLoadObject options]
```

`$anyIxLoadObject option.subcommand sub-options...`

## DESCRIPTION

The `ixConfigSequenceContainer` object provides a list in which commands configure their options.

See the following example:

- `$anIxLoadCommand` is an instance of an `ixLoadCommand`.
- `ixLoadCommand` has an option `listOfIxStuff`.
- `listOfIxStuff` is a list, each of whose elements is of type `ixStuff`, with options `firstIp` and `lastIp`.

In order to create a new instance of `ixLoadCommand` and add an item to its `list`, you should use the following sequence:

```
set $anIxLoadCommand [$::IxLoad new ixLoadCommand]
$anIxLoadCommand listOfIxStuff.appendItem \
-firstIp 192.18.0.1 \
-lastIp 192.18.0.100
```

The first item in a sequence container has index 0. Negative indexes may be used to indicate positions from the last item in the container. -1 corresponds to the last item in the list, -2 to the one before that, and so forth.

## SUBCOMMANDS

The following subcommands are available to handle options. Except where noted, no value is returned; an exception is raised in the case of an error. In all cases where they are used the `option` must begin with a hyphen (-). The `value` must be of a type appropriate for the option.

### **appendItem option value option value...**

The `appendItem` subcommand may be used to add an item to a list. Any number of options in the listed item may be set as part of the append.

### **configItem index option value option value...**

The `configItem` subcommand may be used to configure a particular item in a list. Any number of options in the list item may be set. The `index` argument is used to indicate which item in the list is to be configured.

### **clear**

The `clear` subcommand may be used to delete all listed items from a list.

### **deleteItem index**

The `deleteItem` subcommand may be used to delete a listed item from a list. The `index` argument is used to indicate which item in the list is to be configured.

**find** *mode option value option value...*

The `find` subcommand may be used to search a list for matching criterion. The `mode` argument may be one of:

Option	Usage
<code>exact</code>	Match the <code>value</code> fields exactly.
<code>regexp</code>	Use regular expressions in the matching.
<code>uppercase</code>	Perform a caseless match.

Any number of options may be used in the match. The `find` subcommand searches for all items in the list, whose keyworded options match the values indicated. A list of indexes of matching items is returned.

**getItem** *index*

The `getItem` subcommand may be used to retrieve an item from a list. The `index` argument is used to indicate which item in the list is to be retrieved. This subcommand returns the object from the list.

**indexCount**

The `indexCount` subcommand returns the number of objects in the list.

**insertItem** *index option value option value...*

The `insertItem` subcommand may be used to insert an item in a list. Any number of options in the list item may be set. The `index` argument is used to indicate the insertion point in the list. The new item will be inserted before the `index`'th item in the list.

**OPTIONS**

None.

**EXAMPLE**

```
$list_object.clear$list_object.appendItem -name "sample"$list_object.insertItem 1 -
name "sample2"$list_object.configItem -value "mp4"$list_object.deleteItem -1set
found_list [$list_object.find regexp \
-speed "\\d*[Mm]bps"
$list_object.getItem 3set numObjects [$list_object.indexCount]
```

**ixConfigSortedNamedItemList**

`ixConfigSortedNamedItemList`—Handles a list of objects that is in sorted order.

## SYNOPSIS

```
set anyIxLoadObject [$::IxLoad new ixLoadObject options]
$anyIxLoadObject option.subcommand sub-options...
```

## DESCRIPTION

`ixConfigSortedNamedItemList` behaves similar to `ixConfigSequenceContainer`, except that `getItem` requires the name of an item rather than its index. The `list(index)` notation still works for positional indexing with the `deleteItem` and `configItem` options.

`insertItem` and `appendItem` are not supported; instead an `addItem` method is supported which has the same syntax as `appendItem`. This difference is required because an item's position in the list is controlled by the automatic sorting and cannot be specified by the user.

As with `ixConfigSequenceContainer`, the first item in an `ixConfigSortedNamed` has index 0. Negative indexes indicate positions from the last item in the list. For example, -1 corresponds to the last item in the list, -2 to the one before that, and so forth.

## SUBCOMMANDS

The following subcommands are available to handle options, which are lists. Except where noted, no value is returned; an exception is raised in the case of an error. In all cases where they are used the option must begin with a hyphen (-). The value must be of a type appropriate for the option.

### **addItem** name option value option value...

The `addItem` subcommand adds an item to a list. Any number of options in the list item may be set as part of the addition. Items added with the `addItem` method should always include the `-name` option so that the item can be referenced later. If you do not specify a name, `IxLoad` will assign a default name, but you should not rely on default names because future releases of `IxLoad` may assign different default names. After `addItem` has been executed, it returns the object that has been added so that you can use the `config` subcommand to configure it.

### **configItem** index option value option value...

The `configItem` subcommand configures a particular item in a list. You can pass multiple option/value pairs in one command, so that the command configures multiple options at the same time. The `index` argument specifies the list item to be configured. To determine the index number of an item, use the `find` subcommand.

### **clear**

The `clear` subcommand deletes all items from a list.

### **deleteItem** index

The `deleteItem` subcommand deletes an item from a list. The `index` argument specifies the list item to be deleted. To determine the index number of an item, use the `find` subcommand. To delete an

item by name, use the `removeItem` sub-command.

### **find** mode option value option value...

The `find` subcommand searches a list for item that matches its search criteria. The `mode` argument may be one of:

Option	Usage
<code>exact</code>	Match the <code>value</code> fields exactly.
<code>regexp</code>	Use regular expressions in the matching.
<code>uppercase</code>	Perform a caseless match.

Any number of options may be used in the match. The `find` subcommand searches for all items in the list, whose keyworded options match the values. A list of indexes of matching items is returned.

### **getItem** name

The `getItem` subcommand may be used to retrieve an item from a list. The `name` argument is used to indicate which item in the list is to be retrieved. This subcommand returns the object from the list.

### **indexCount**

The `indexCount` subcommand returns the number of objects in the list.

### **removeItem** name

The `removeItem` subcommand deletes an item from a list. The `name` argument specifies the list item to be deleted. To delete an item by its index, use the `deleteItem` subcommand.

## **OPTIONS**

None.

## **EXAMPLE**

```
$list_object.clear$list_object.addItem -name "sample"$list_object.configItem -value "mp4"set found_list [$list_object.find regexp \  
-speed "\\d*[Mm]bps"]  
$list_object.getItem "sample"set numObjects [$list_object.indexCount]$list_object.de-  
leteItem -1
```

## **SEE ALSO**

[ixConfigSequenceContainer](#)

[ixRepository](#)

! 6

This page intentionally left blank.



## Network Stack API

Beginning with release 4.10, IxLoad uses an object-oriented model for its network stack. TCL scripts created with previous releases of IxLoad will still function, but any scripts created using ScriptGen will use the object-oriented network stack.

The following sections describe the object model.

## Network Stack Overview

The IxLoad network stack is organized as follows:

- Network groups contain a list of network-specific settings, the foundation protocol (L1 Ethernet), and the list of global plugins. Network groups are sometimes referred to as Port Groups, the term used for them in IxNetwork.
- Global plugins modify settings of port groups. For example, the TCP global plugin modifies the TCP parameters for the port group that it belongs to.
- Layer plugins correspond to layers of a network communication stack. These are the protocols that you would see if captured the traffic and looked at it in a packet analyzer -- a packet header would be present. For example, for an Ethernet plugin, an Ethernet packet would be present. For a PPP plugin, a PPP header would be present.
- Extension plugins modify behavior of associated Layer plugins. For example, the 802.1x Extension protocol modifies the functionality of a MAC layer plugin. Impairment is another extension protocol -- it can be applied to a single protocol to damage or drop packets, but it has no header or other identifier that can be seen in a packet capture.

## Network Stack Hierarchy

The figure below shows the network stack hierarchy in conceptual form and using examples of what you might see if you use ScriptGen to create a Tcl script of an IxLoad test. Each element is described in a subsequent section.

## Test, scenario, and column

The test element resides at the top of the test. The test contains a property called `scenarioList`, which holds the test scenario.

The scenario contains a property called `columnList`, which holds one or more columns.

Each column contains a property called `scenarioElementList`, which holds the list of nettraffics or DUTs in the test.

The following example shows how to add a nettraffic to a test.

```
set Test1 [::IxLoad new ixTest]

set scenarioElementFactory [$Test1 getScenarioElementFactory]

set scenarioFactory [$Test1 getScenarioFactory]

$Test1 scenarioList.clear

set New_Traffic_Flow [$scenarioFactory create "TrafficFlow"]
$New_Traffic_Flow columnList.clear

set Originate [::IxLoad new ixTrafficColumn]
$Originate elementList.clear

set Traffic1_Network1 [$scenarioElementFactory create $::ixScenarioElementType
(kNetTraffic)]
```

## Network Group Overview

The network element is a member of the column's nettraffic, and defines a Network Group.

```
set Network1 [$Traffic1_Network1 cget -network]

$Network1 globalPlugins.clear
```

Network groups contain a list of network-specific settings, the foundation protocol (L1 Ethernet), and the list of global plugins.

The foundation layer in an IxLoad stack is an L1 Ethernet plugin. Every time you create a port group, the L1 Ethernet plugin is created automatically for you. To create it explicitly, you call `getL1Plugin`.

```
set Ethernet_1 [$Network1 getL1Plugin]
```

The network group data holds data that affects a network stack protocol that runs over a specific set of ports. Network groups are sometimes referred to as Port Groups, the term used for them in IxNetwork.

In the IxLoad GUI, the network group data is accessed by clicking the Network Group Settings tab. For example, in the following figure, you would access the network group data for the PPPoX plugin by clicking the Network Group Settings tab:

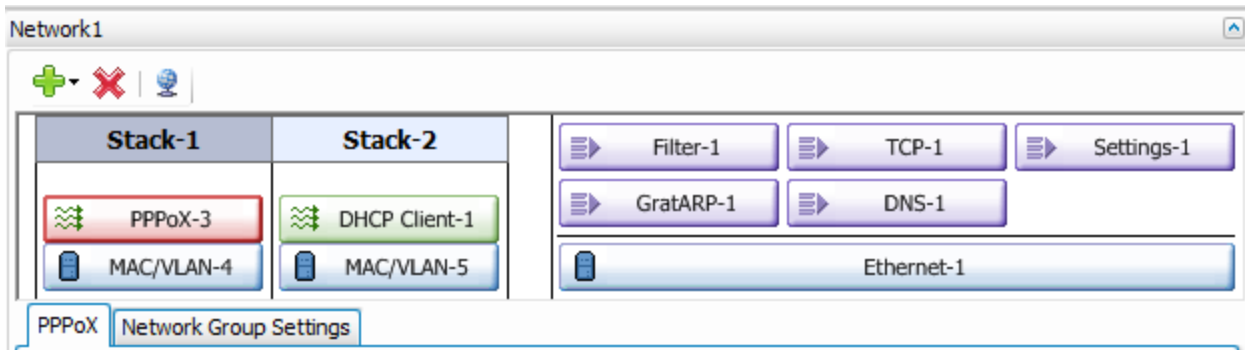

## Global plugins

Global plugins modify settings of port groups. For example, the TCP global plugin modifies the TCP parameters for the port group that it belongs to. In the IxLoad GUI, the global plugins are displayed in the scenario editor opposite the network stacks.

You script the parameters for the global plugins once per test.

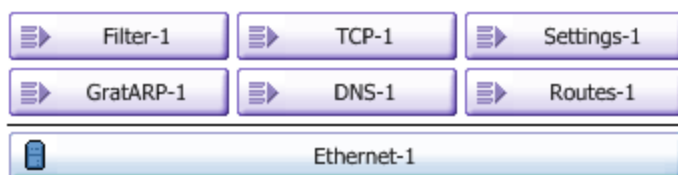

To add a global plugin, you add it as an element of the list of Global plugins:

```
set Network1 [$Traffic1_Network1 cget -network]$Network1 globalPlugins.clear
```

```
set Filter_1 [::IxLoad new ixNetFilterPlugin]$Network1 globalPlugins.appendItem -
object $Filter_1
```

After adding it to the list, you then configure it:

```
$Filter_1 config \-all                                     false \-pppoecontrol
false \-isis                                             false \
```

## Stacks and Protocol Plugins

This section describes the elements of a network stack.

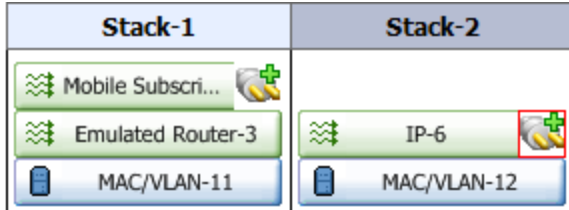

## Global options

Most protocols have Global options, which define the behavior of a protocol in all the ranges. There is only one instance of Global options for each protocol. They affect every instance of the protocol running on every port in the test. The Global Options are stored in the session-specific data. The session-specific data is unique to a single instance of an IxLoad test.

In the IxLoad GUI, these are configured by clicking on the Globe icon above the network stacks.

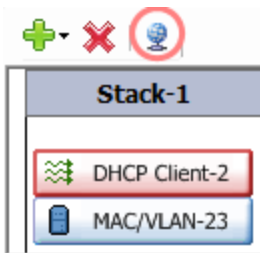

You should script a protocol's global options when you add the first instance of the protocol.

The global options can be set in Tcl by creating a structure to hold the options, and then calling `getSessionSpecificData` and passing the name of the protocol.

For example, to set the PPPoX global options:

```
set my_ixNetPppoxSessionData [$Test1 getSessionSpecificData "PppoxPlugin"]$my_
ixNetPppoxSessionData config \-teardownRateInitial          300 \-
acceptPartialConfig          true \-maxOutstandingRequests
300 \-maxOutstandingReleases          300 \-setupRateInitial
300
```

Each protocol has a reserved string that is passed as an argument to `getSessionSpecificData`. For a list of strings, see Plugin name strings.

## Plugin name strings

The table below lists the names of the plugins to use for the `GetSessionSpecificData` and `GetNetworkSpecificData` commands.

Protocol Plugins	Plugin Name String
802.1x	Dot1xPlugin
DHCP Client	DHCPPlugin
DHCP Server	DHCPServerPlugin
EAPoUDP	Nacl3Plugin
eGTP S1/S11 eNB/MME	EGTPPlugin
eGTP S1/S11 eNB/SGW	EGTPPlugin_SGW
Emulated Router	N/A
GTP	GTPSPlugin
GTP-GGSN	GTPGPlugin
Impair	ImpairPlugin
IP	IPv4V6Plugin
IPSec	IPSecPlugin
L2EthernetPlugin (MAC/VLAN)	N/A
L2TP	L2tpPlugin
Mobile Subscribers	MobileSubscribersPlugin
PPPoX	PppoxPlugin
Radius	RadiusPlugin
Static ARP	N/A
WebAuth	WebAuthPlugin

## Network Group Settings

The network group settings contain the network-specific settings for a network group.

The network group settings can be set in Tcl by configuring the Port Group Specific Data, a list that holds the network group options for a specific protocol in the network group. There is a set of options for each protocol in the network group.

For example:

```
set my_ixNetPppoxPortGroupData [$client_network getNetworkSpecificData "PppoxPlugin"]
$my_ixNetPppoxPortGroupData activities.clear

$my_ixNetPppoxPortGroupData associates.clear

$my_ixNetPppoxPortGroupData config \
    -useWaitForCompletionTimeout      false \
    -maxOutstandingRequests           300 \
    -perSessionStatFilePrefix         "MY_PREFIX" \
    -enablePerSessionStatGeneration  false \
    -waitForCompletionTimeout         120 \
    -maxOutstandingReleases           300 \
    -overrideGlobalRateControls       false \
    -role                             "client" \
    -filterDataPlaneBeforeL7          true \
    -teardownRateInitial              300 \
    -setupRateInitial                 300
```

## L2 Plugin

To build the stack, you add plugins as children of other plugins. The first plugin that you add to the stack is an L2 plugin. There is one L2 plugin per stack.

After the L1 plugin has been created, you add the L2 plugin as its child, using the `appendItem` command to add it to the `childrenList` property. Children lists are ranges of configuration data for the plugin being added. Most plugins have one range, but some have two. For example, an Ethernet range has a MAC range and VLAN range as its children.

For example, to create a MAC address range, you add it to the `childrenList` of the Ethernet plugin.

```
set MAC_VLAN_1 [::IxLoad new ixNetL2EthernetPlugin]$Ethernet_1 childrenList.appendItem -object $MAC_VLAN_1
```

## Adding Layer Plugins

To add additional higher-layer protocols to the stack, you add them as ranges, again using `appendItem`:

```
$PPPoX_4 rangeList.clearset PPPoX_R4 [::IxLoad new ixNetPppoxRange]$PPPoX_4 rangeList.appendItem -object $PPPoX_R4
```

## Extension plugins

Extension plugins modify the behavior of the protocols they are associated with. To add an extension plugin, you add it to its associated protocol's `extensionList` property using the `appendItem` command:

```
set Impair_1 [::IxLoad new ixNetImpairPlugin]$PPPoX_1 extensionList.appendItem -object $Impair_1
```

Then, you configure the extension plugin's range and parameters, and then enable it:

```
set Impair_R1 [$PPPoX_R1 getExtensionRange $Impair_1]
```

```
set DefaultProfile [::IxLoad new ixNetImpairProfile]$DefaultProfile config \-
addFragment true \-sendFirstFragmentOnly
false \-fragmentSequenceLength 32 \-addFragmentSequence
true \-sendFragmentsInReverseOrder true
```

```
$Impair_R1 config \-enabled true \-profile
$DefaultProfile
```

## Ethernet Plugin

### SYNOPSIS

## DESCRIPTION

First plugin for all Ethernet stacks. This element is preconfigured to be the first element of the stack in the Network Group. You can get this item from the network by calling `get NetworkPlugin`.

## SUBCOMMANDS

### OPTIONS

`name`

Name of the instance of the plugin.

Default value = "None"

`childrenList`

Name of the list of next-lower layer plugins.

Default value = "None"

`extensionList`

Name of the list of protocol extensions.

Default value = "None"

`autoNegotiate`

If `true`, the Ixia port auto-negotiates its speed and duplex operation with the DUT, using the values that you select for the *Speed* parameter. If `false`, the Ixia port uses the speed that you select for the *Speed* parameter.

Value	Description
copper	Use copper mode.
fiber	Use fiber mode.
auto	Automatically select the media type .

Default value = "True"

`speed`

If `autoNegotiate` is `true`, this parameter lists the speeds that the Ixia port advertises.

Value	Description
k10FD	10Mbit Full Duplex



k10HD	10Mbit Half Duplex
k100FD	100Mbit Full Duplex
k100HD	100Mbit Half Duplex
k1000	1 Gigabit
k10000	10 Gigabit

Default value = "k100FD"

advertise10Half

If true, the Ixia port advertises 10 Mbps half duplex speed.

Default value = "True"

name="advertise10Full"

If true, the Ixia port advertises 10 Mbps full duplex speed.

Default value = "True"

name="advertise100Half"

If true, the Ixia port advertises 100 Mbps half duplex speed.

Default value = "True"

name="advertise100Full"

If true, the Ixia port advertises 100 Mbps full duplex speed.

Default value = "True"

name="advertise1000Full"

If true, the Ixia port advertises 1 Gbps full duplex speed.

Default value = "True"

name="cardElm"

Default value = "None"

## EXAMPLE

## SEE ALSO

## Ethernet ELM options

### SYNOPSIS

### DESCRIPTION

Defines the parameters for using an Encrypting Load Module (ELM) in an IxLoad test.

### SUBCOMMANDS

### OPTIONS

`enabled`

If `true`, an ELM port will be configured as an ELM port.

If `false`, an ELM port will be configured as a generic Ethernet port.

Default value = "False"

`negotiateMasterSlave`

If `true`, the master/slave relationship of all ports will be auto-negotiated.

If `false`, the `negotiationType` value determines the master/slave relationship.

Default value = "True"

`negotiationType`

If `negotiateMasterSlave` is `false`, this value determines the role (master or slave) of the ELM port.

Value	Description
master	Port is master.
slave	Port is slave.

Default value = "master"

### EXAMPLE

```
set my_ixNetEthernetELMPlugin [::IxLoad new ixNetEthernetELMPlugin]$my_ixNetEthernetELMPlugin config \-negotiationType "master" \-negotiateMasterSlave true
```

```

$Ethernet_1 config \-advertise10Full
"Ethernet-1" \-autoNegotiate
true \-advertise10Half
"k100FD" \-advertise1000Full
true \-cardElm
  $Ethernet_1 childrenList.clear
  $Ethernet_1 extensionList.clear
true \-name
true \-advertise100Half
true \-speed
true \-advertise100Full
$my_ixNetEthernetELMPlugin

```

**SEE ALSO**

## Physical Layer Example

This section shows an example of how to create a physical layer plugin in the Tcl API.

## Physical Layer Example

```

#####
# IxLoad ScriptGen created TCL script
# Network1 serialized using version 4.10.0.79
# Basic.tcl made on Aug 14 2008 14:58
#####

set Network1 [::IxLoad new ixNetworkGroup $chassisChain]
$Network1 config \
  -comment          "" \
  -name             "Network1" \
  -macMappingMode   0 \
  -linkLayerOptions 0

$Network1 globalPlugins.clear

```

Create a network group.

Clear the global plugins list.

Begin appending items to global plugin list.

```

set GratARP [::IxLoad new ixNetGratArpPlugin]
# ixNet objects needs to be added in the list
# before they are configured!
$Network1 globalPlugins.appendItem -object $GratARP

```

Optionally, enable Gratuitous ARP.

```

$GratARP config \
  -enabled          true \
  -name            "GratARP"

```

```
set TCP [::IxLoad new ixNetTCPPlugin]
# ixNet objects needs to be added in the list
# before they are configured!
$Network1 globalPlugins.appendItem -object $TCP
```

Configure the TCP  
portion of the stack.

```
$TCP config \
    -tcp_bic 0 \
    -tcp_tw_recycle true \
    -tcp_retries2 5 \
    -tcp_retries1 3 \
    -tcp_keepalive_time 75 \
    -tcp_moderate_rcvbuf 0 \
    -tcp_rfc1337 false \
    -tcp_ipfrag_time 30 \
    -tcp_rto_max 60000 \
    -tcp_vegas_alpha 2 \
    -tcp_ecn false \
    -tcp_westwood 0 \
    -tcp_rto_min 1000 \
    -tcp_reordering 3 \
    -tcp_vegas_cong_avoid 0 \
    -tcp_keepalive_intvl 7200 \
    -tcp_rmem_max 262144 \
    -tcp_orphan_retries 0 \
    -tcp_max_tw_buckets 180000 \
    -tcp_wmem_default 4096 \
    -tcp_low_latency 0 \
    -tcp_rmem_min 4096 \
    -tcp_adv_win_scale 2 \
    -tcp_wmem_min 4096 \
    -tcp_port_min 1024 \
    -tcp_stdurg false \
    -tcp_port_max 65535 \
    -tcp_fin_timeout 60 \
    -tcp_no_metrics_save false \
    -tcp_dsack true \
    -tcp_mem_high 49152 \
    -tcp_frto 0 \
    -tcp_app_win 31 \
    -ip_no_pmtu_disc false \
    -tcp_window_scaling false \
    -tcp_max_orphans 8192 \
    -tcp_mem_pressure 32768 \
    -tcp_syn_retries 5 \
    -name "TCP" \
```

```

set Settings [::IxLoad new ixNetIxLoadSettingsPlugin]
# ixNet objects needs to be added in the list
# before they are configured!
$Network1 globalPlugins.appendItem -object $Settings

$Settings config \
    -teardownInterfaceWithUser      false \
    -name                            "Settings" \
    -interfaceBehavior              0

set Ethernet_1 [$Network1 getLLPlugin]

set my_ixNetEthernetELMPlugin [::IxLoad new ixNetEthernetELMPlugin]
$my_ixNetEthernetELMPlugin config \
    -negotiationType                "master" \
    -negotiateMasterSlave           true

$Ethernet_1 config \
    -advertise10Full                true \
    -name                            "Ethernet-1" \
    -autoNegotiate                  true \
    -advertise100Half               true \
    -advertise10Half                true \
    -speed                          "k100FD" \
    -advertise1000Full              true \
    -advertise100Full               true \
    -cardElm

$my_ixNetEthernetELMPlugin

$Ethernet_1 childrenList.clear

$Ethernet_1 extensionList.clear

#####
# Setting the ranges starting with the plugin on top of the stack
#####

```

Configure the Dynamic Control plane settings.

Configure the physical layer properties.

## Layer 2 Protocols (MAC / VLAN)

This section describes the Layer 2 protocol (MAC / VLAN) plugins.

### L2EthernetPlugin

## SYNOPSIS

## DESCRIPTION

Plugin that describes the MAC and VLAN settings. This object appears as MAC/VLAN in the GUI.

## SUBCOMMANDS

## OPTIONS

name

Name of the instance of the plugin.

Default value = "None"

childrenList

Name of the list of next-lower layer plugins.

Default value = "None"

extensionList

Name of the list of protocol extensions.

Default value = "None"

macRangeList

Name of the list of MAC address ranges used by this plugin. The list must be a `MacRangeList` object.

Default value = "None"

vlanRangeList

Name of the list of VLAN tag ranges used by this plugin. The list must be a `VlanIdRangeList` object.

Default value = "None"

## EXAMPLE

```
set MAC_VLAN_3 [::IxLoad new ixNetL2EthernetPlugin]# ixNet objects needs to be added
in the list before they are configured!$Ethernet_1 childrenList.appendItem -object
$MAC_VLAN_3
```

```
$MAC_VLAN_3 config \-name "MAC/VLAN-3"
```

```
$MAC_VLAN_3 childrenList.clear
```

**SEE ALSO****L2 Ethernet (MAC/VLAN) Port Group Data****SYNOPSIS****DESCRIPTION**

Options for Layer 2 Ethernet port groups.

**SUBCOMMANDS****OPTIONS**

`activityID`

Activity ID.

Default value = "0"

`activities`

List of activities.

Default Value = "None"

**EXAMPLE****SEE ALSO****MAC Session Data**

## SYNOPSIS

## DESCRIPTION

Global MAC settings for the `L2EthernetPlugin`.

## SUBCOMMANDS

## OPTIONS

`duplicateCheckingScope`

Value used to scope of check to determine whether IP is unique within the session, within the port group, or disabled.

Value	Description
0	Disabled
1	PortGroup
2	Session

Default value = "None"

## EXAMPLE

## SEE ALSO

## MAC Range

## SYNOPSIS

## DESCRIPTION

Range of MAC addresses. Configure the range as a list.



## SUBCOMMANDS

### OPTIONS

name

Name of the instance of the plugin.

Default value = "None"

enabled

If `True`, the range is enabled.

Default value="True".

mac

The base value used when the network stack element creates MAC addresses. This address will be associated with the first interface on the port.

This parameter is available for editing only when the *AutoGenerate MAC* option is disabled (in the layer 3 stack element).

When you require a range of multiple MAC addresses, the network stack element uses this base address plus the *Increment* value to create the range of addresses.

**Note:** If you are using VM ports, the default behavior of the test is to use the MAC address cloned from the NIC, rather than the configured address. To override this behavior and manually configure the MAC addresses, enable promiscuous mode in IxExplorer for each port and also enable promiscuous mode on the VmWare ESX virtual switch.

Default value (for API)=" " (none)

incrementBy

The value that is used (in conjunction with the base MAC address) to create a range of multiple MAC addresses.

Default value="'00:00:00:00:00:01'"

mtu

Maximum Transmission Unit (MTU) is the largest packet that a given network medium can carry.

Ethernet, for example, has a standard MTU of 1500 bytes, ATM has a fixed MTU of 48 bytes, and PPP has a negotiated MTU that is usually between 500 and 2000 bytes.

The default value is 1500, the minimum value is 500, and the maximum value is 9500.

Default value="1500".

count

Number of MAC addresses to create.

Default value="1".

vlanRange

Name of the VLAN range associated with the MAC address.

Default value="None".

### **EXAMPLE**

```
set MAC_R2 [$DHCP_R1 getLowerRelatedRange "MacRange"]
```

```
$MAC_R2 config \
```

```
-count          1 \  
-name           "MAC-R2" \  
-enabled        true \  
-mtu            1500 \  
-mac            "22:73:F7:4E:00:00" \  
-incrementBy    "00:00:00:00:00:01"
```

### **SEE ALSO**

## **VLAN ID Range**

### **SYNOPSIS**

### **DESCRIPTION**

Range of VLAN IDs.

### **SUBCOMMANDS**

## OPTIONS

`name`

Name of the instance of the plugin.

Default value = "None"

`enabled`

If `True`, the range base is enabled.

Default value="True".

`enable`

When enabled, the outer VLAN range is included in the configuration.

Default value="False"

`firstId`

The first VLAN ID to be used for the outer VLAN tag.

Valid VLAN IDs are in the range of 1 through 4094 (IDs 0 and 4095 are reserved).

Default value="1"

`incrementStep`

The value to be added to the outer VLAN ID for each new assignment. The maximum value is 4093.

Default value="1"

`increment`

How often a new outer VLAN ID is generated. For example, a value of 10 will cause a new VLAN ID to be used in blocks of 10 IP addresses.

When using Inner First increment mode, this parameter determines how many inner cycles must be completed before a new outer VLAN ID is generated. For example if *Increment every...* is 2, a new outer VLAN ID is generated following two inner VLAN ID cycles.

(A cycle is complete when the Unique Count has been reached for inner VLAN IDs.)

Default value="1"

`uniqueCount`

The number of unique outer VLAN IDs that will be created. The default value is 4094.

Default value="4094"

`priority`

The 802.1Q priority for the outer VLAN. The minimum value is zero; the maximum value is 7.

Default value="1"

`innerEnable`

When enabled, the inner VLAN range is included in the configuration.

Inner VLAN cannot be enabled unless Outer VLAN is enabled.

Default value="False"

`innerFirstId`

The first VLAN ID to be used for the inner VLAN tag.

Valid VLAN IDs are in the range of 1 through 4094 (IDs 0 and 4095 are reserved).

Default value="1"

`innerIncrementStep`

The value to be added to this inner VLAN ID for each new assignment. The maximum value is 4093.

Default value="1"

`innerIncrement`

How often a new inner VLAN ID is generated. For example, a value of 10 will cause a new VLAN ID to be used in blocks of 10 IP addresses.

When using Outer First increment mode, this parameter determines how many outer cycles must be completed before a new inner VLAN ID is generated. For example if *Increment every...* is 2, a new inner VLAN ID is generated following two outer VLAN ID cycles.

(A cycle is complete when the Unique Count has been reached for outer VLAN IDs.)

Default value="1"

`innerUniqueCount`

The number of unique inner VLAN IDs that will be created. The default value is 4094.

Default value="4094"

`innerPriority`

The 802.1Q priority for this inner VLAN. The minimum value is zero; the maximum value is 7.

Default value="1"

`idIncrMode`

The Method used to increment VLAN IDs:

- Outer VLAN first - The outer VLAN ID is incremented first. When the Unique Count is reached the number of times specified by the *Increment every...* parameter, the inner VLAN ID is incremented.

- Inner VLAN first - The inner VLAN ID is incremented first. When the Unique Count is reached the number of times specified by the *Increment every...* parameter, the outer VLAN ID is incremented.
- Both - Both VLAN IDs are incremented at the same time.

Refer to VLAN Increment Examples for more information about VLAN increment modes.

Default value="2"

## EXAMPLE

```
set VLAN_R1 [$DHCP_R1 getLowerRelatedRange "VlanIdRange"]
```

```
$VLAN_R1 config \  
-incrementStep          1 \  
-uniqueCount            4094 \  
-name                   "VLAN-R1" \  
-innerIncrement         1 \  
-innerUniqueCount       4094 \  
-enabled                true \  
-innerFirstId           1 \  
-increment              1 \  
-priority               1 \  
-firstId                1 \  
-innerIncrementStep     1 \  
-idIncrMode             2 \  
-innerEnable            false \  
-innerPriority           1
```

## SEE ALSO

## Layer 2 Example

This section shows an example of how to create a layer 2 plugin in the Tcl API.

### Layer 2 Example

```
#####
# IxLoad ScriptGen created TCL script
# Network1 serialized using version 4.10.0.79
# MAC VLAN.tcl made on Aug 14 2008 15:16
#####

set Network1 [::IxLoad new ixNetworkGroup $chassisChain]
$Network1 config \
    -comment          "" \
    -name              "Network1" \
    -macMappingMode    0 \
    -linkLayerOptions  0

$Network1 globalPlugins.clear

set GratARP [::IxLoad new ixNetGratArpPlugin]
# ixNet objects needs to be added in the list
# before they are configured!
$Network1 globalPlugins.appendItem -object $GratARP

$GratARP config \
    -enabled          true \
    -name              "GratARP"
```

Create a network group.

Clear the global plugins list.

Begin appending items to global plugin list.

Optionally, enable Gratuitous ARP.

```

set TCP [::IxLoad new ixNetTCPPlugin]
# ixNet objects needs to be added in the list
# before they are configured!
$Network1 globalPlugins.appendItem -object $TCP

```

Configure the TCP  
portion of the stack.

```

$TCP config \
  -tcp_bic 0 \
  -tcp_tw_recycle true \
  -tcp_retries2 5 \
  -tcp_retries1 3 \
  -tcp_keepalive_time 75 \
  -tcp_moderate_rcvbuf 0 \
  -tcp_rfc1337 false \
  -tcp_ipfrag_time 30 \
  -tcp_rto_max 60000 \
  -tcp_vegas_alpha 2 \
  -tcp_ecn false \
  -tcp_westwood 0 \
  -tcp_rto_min 1000 \
  -tcp_reordering 3 \
  -tcp_vegas_cong_avoid 0 \
  -tcp_keepalive_intvl 7200 \
  -tcp_rmem_max 262144 \
  -tcp_orphan_retries 0 \
  -tcp_max_tw_buckets 180000 \
  -tcp_wmem_default 4096 \
  -tcp_low_latency 0 \
  -tcp_rmem_min 4096 \
  -tcp_adv_win_scale 2 \
  -tcp_wmem_min 4096 \
  -tcp_port_min 1024 \
  -tcp_stdurg false \
  -tcp_port_max 65535 \
  -tcp_fin_timeout 60 \
  -tcp_no_metrics_save false \
  -tcp_dsack true \
  -tcp_mem_high 49152 \
  -tcp_frto 0 \
  -tcp_app_win 31 \
  -ip_no_pmtu_disc false \
  -tcp_window_scaling false \
  -tcp_max_orphans 8192 \
  -tcp_mem_pressure 32768 \
  -tcp_syn_retries 5 \

```

```
set Settings [::IxLoad new ixNetIxLoadSettingsPlugin]
# ixNet objects needs to be added in the list
# before they are configured!
$Network1 globalPlugins.appendItem -object $Settings

$Settings config \
    -teardownInterfaceWithUser      false \
    -name                            "Settings" \
    -interfaceBehavior              0

set Ethernet_1 [$Network1 getL1Plugin]

set my_ixNetEthernetELMPlugin [::IxLoad new ixNetEthernetELMPlugin]
$my_ixNetEthernetELMPlugin config \
    -negotiationType                "master" \
    -negotiateMasterSlave           true

$Ethernet_1 config \
    -advertise10Full                true \
    -name                            "Ethernet-1" \
    -autoNegotiate                  true \
    -advertise100Half               true \
    -advertise10Half                true \
    -speed                          "k100FD" \
    -advertise1000Full              true \
    -advertise100Full               true \
    -cardElm

$my_ixNetEthernetELMPlugin

$Ethernet_1 childrenList.clear
```

Configure the Dynamic  
Control plane settings.

Configure the physical  
layer properties.



```

set MAC_VLAN_2 [::IxLoad new ixNetL2EthernetPlugin]
# ixNet objects needs to be added in the list
# before they are configured!
$Ethernet_1 childrenList.appendItem -object $MAC_VLAN_2

$MAC_VLAN_2 config \
    -name "MAC/VLAN-2"

$MAC_VLAN_2 childrenList.clear
$MAC_VLAN_2 extensionList.clear
$Ethernet_1 extensionList.clear

#####
# Setting the ranges starting with the plugin on top of the stack
#####
$MAC_VLAN_2 macRangeList.clear

$MAC_VLAN_2 vlanRangeList.clear

```

Configure the MAC addresses and VLAN tags.

Clear the lists of extension protocols.

## Emulated Router Plugin

### SYNOPSIS

### DESCRIPTION

Used over `L2EthernetPlugin` to define an emulated router.

### SUBCOMMANDS

### OPTIONS

`name`

Name of the instance of the plugin.

Default value = "None"

`childrenList`

Name of the list of next-lower layer plugins.

Default value = "None"

`extensionList`

Name of the list of protocol extensions.

Default value = "None"

`EmulatedRouterRangeList`

List of `EmulatedRouterRange` objects.

Default value="None".

## **EXAMPLE**

## **SEE ALSO**

# **EmulatedRouterRange**

## **SYNOPSIS**

## **DESCRIPTION**

Defines a range of IP addresses that will be used by an emulated router.

You need to assign one port per address to this range.

Configure the range as a list.

## **SUBCOMMANDS**

## **OPTIONS**

`name`

Name of the instance of the plugin.

Default value = "None"

`enabled`

If `True`, the range base is enabled.

Default value="True".

`ipType`

Indicates the IP version for each range:

- IPv4
- IPv6

The default value is IPv4.

Must be one of the choices in `IpTypeChoices`. Default value="'IPv4'".

`ipAddress`

The first IP address in the range. This is the base address used for enumerating all the addresses in the range.

The default IPv4 address is 10.10.10.2, and the default IPv6 address is ::A0A:A02.

**Note:** IxOS reserves a range of addresses for use in the Ixia chassis VNIC network; the default reserved range is the 10.0.0.0 /16 subnet. If you attempt to configure IP addresses from this reserved subnet, IxLoad will reject the address assignment.

Default value="'10.10.0.1'".

`prefix`

The number of one bits in the subnet mask. For example, a mask of 255.255.240.0 has a prefix of 20.

The default IPv4 value is 24, and the default IPv6 value is 120.

Default value="16".

`incrementBy`

The value used to enumerate all the addresses in the range.

The default IPv4 value is 0.0.0.1. The default IPv6 value is ::1.

Default value="1".

`gatewayAddress`

The gateway address to be associated with all the addresses in the range.

If the Protocol is IPv6, the Gateway field adds a default route to this gateway for the range (unless the gateway is 0::0, in which case the route is not added).

The default IPv4 value is 10.10.10.1. The default IPv6 value is ::A0A:A01.

**Note:** When you configure an Emulated Router in an IP stack, the Emulated Router provides the gateway addresses for the IP ranges. In this case, the IP gateway parameters are not configurable.

Default value="'0.0.0.0'".

`gatewayIncrement`

Defines the address increment value that is used to generate each gateway address required in the . (The gateway addresses are incremented according to the *Gateway Increment Mode*.)

The default IPv4 value is 0.0.0.0, and the default IPv6 value is ::0. When the default value is used, the base gateway address will not be incremented. Rather, all gateway IPs will be the same for all interfaces generated by the plug-in range.

Default value="0.0.0.0"

`gatewayIncrementMode`

Determines when the gateway addresses are incremented. The options are:

- Increment every subnet: A new gateway address is created for each subnet defined in the network group. With this mode, the increment operation is triggered when a range IP increment operation creates an IP address that is in a new subnet.
- Increment every interface: A new gateway address is created for each interface, whether or not the next address is from the same subnet.

The default is *Increment Every Subnet*.

Refer to Static IP Plug-in Gateway Addresses for more information.

Must be one of the choices in `GatewayIncrementModeChoices`. Default value="perSubnet".

`generateStatistics`

When this parameter is enabled, IxLoad will collect interface statistics for this range.

Values=True/False. Default value="False".

`mss`

The Maximum Segment Size. The MSS is the largest amount of data, specified in bytes, that the IP device can transmit as a single, unfragmented unit.

The TCP MSS equals the MTU minus the TCP header size minus the IP header size.

The MSS value can (theoretically) be as large as 65495. For traditional Ethernet, the maximum value is 1460 (1500 minus 40). For jumbo frame support, the maximum value is 9460 (9500 minus 40). IxLoad supports jumbo frames.

The default value is 1460.

Default value="1460".

`autoMacGeneration`

This parameter is used to automatically generate MAC addresses:

- If enabled, MAC addresses will be automatically generated based on the IP addresses, in which case the associated MAC range is ignored.

If disabled, the associated MAC range is used to create the MAC addresses.

Values=True/False. Default value="True".

macRange

Name of the MAC range. Must be one of the choices in MacRange.

Default value="None".

vlanRange

Name of the VLAN range. Must be one of the choices in VlanIdRange.

Must be one of the choices in VlanIdRange. Default value="None".

### EXAMPLE

```
set ER_R1 [::IxLoad new ixNetEmulatedRouterRange]# ixNet objects needs to be added
in the list before they are configured!$Emulated_Router_1 rangeList.appendItem -
object $ER_R1
```

```
$ER_R1 config \-count 1 \-name
"ER-R1" \-gatewayAddress "0.0.0.0" \-enabled
true \-autoMacGeneration true \-mss
1460 \-incrementBy "0.0.0.1" \-prefix
16 \-gatewayIncrement "0.0.0.0" \-gatewayIncrementMode
"perSubnet" \-generateStatistics false \-ipAddress
"10.10.0.3" \-ipType "IPv4"
```

### SEE ALSO

## Emulated Router Example

This section shows an example of how to create an Emulated Router in the Tcl API.

## Emulated Router Example

```
#####
# IxLoad ScriptGen created TCL script
# Network1 serialized using version 4.10.0.79
# EmulatedRouter.tcl made on Aug 21 2008 14:01
#####

set Network1 [::IxLoad new ixNetworkGroup $chassisChain]
$Network1 config \
    -comment          "" \
    -name              "Network1" \
    -macMappingMode   1 \
    -linkLayerOptions 0

$Network1 globalPlugins.clear

Begin appending items to global plugin list.

set GratARP [::IxLoad new ixNetGratArpPlugin]
# ixNet objects needs to be added in the list
# before they are configured!
$Network1 globalPlugins.appendItem -object $GratARP

$GratARP config \
    -enabled          true \
    -name              "GratARP"
```

Create a network group.

Clear the global plugins list.

Begin appending items to global plugin list.

Optionally, enable  
Gratuitous ARP.

```

set TCP [::IxLoad new ixNetTCPPlugin]
# ixNet objects needs to be added in the
# list before they are configured!
$Network1 globalPlugins.appendItem -object $TCP

$TCP config \
    -tcp_bic 0 \
    -tcp_tw_recycle true \
    -tcp_retries2 5 \
    -tcp_retries1 3 \
    -tcp_keepalive_time 75 \
    -tcp_moderate_rcvbuf 0 \
    -tcp_rfc1337 false \
    -tcp_ipfrag_time 30 \
    -tcp_rto_max 60000 \
    -tcp_vegas_alpha 2 \
    -tcp_ecn false \
    -tcp_westwood 0 \
    -tcp_rto_min 1000 \
    -tcp_reordering 3 \
    -tcp_vegas_cong_avoid 0 \
    -tcp_keepalive_intvl 7200 \
    -tcp_rmem_max 262144 \
    -tcp_orphan_retries 0 \
    -tcp_max_tw_buckets 180000 \
    -tcp_wmem_default 4096 \
    -tcp_low_latency 0 \
    -tcp_rmem_min 4096 \
    -tcp_adv_win_scale 2 \
    -tcp_wmem_min 4096 \
    -tcp_port_min 1024 \
    -tcp_stdurg false \
    -tcp_port_max 65535 \
    -tcp_fin_timeout 60 \
    -tcp_no_metrics_save false \
    -tcp_dsack true \
    -tcp_mem_high 49152 \
    -tcp_frto 0 \
    -tcp_app_win 31 \
    -ip_no_pmtu_disc false \
    -tcp_window_scaling false \
    -tcp_max_orphans 8192 \
    -tcp_mem_pressure 32768 \
    -tcp_syn_retries 5 \
    -name "TCP" \

```

Configure the TCP  
portion of the stack.

```
set Settings [::IxLoad new ixNetIxLoadSettingsPlugin]
# ixNet objects needs to be added in the list
# before they are configured!
$Network1 globalPlugins.appendItem -object $Settings

$Settings config \
    -teardownInterfaceWithUser      false \
    -name                            "Settings" \
    -interfaceBehavior              0

set Ethernet_1 [$Network1 getL1Plugin]

set my_ixNetEthernetELMPlugin [::IxLoad new ixNetEthernetELMPlugin]
$my_ixNetEthernetELMPlugin config \
    -negotiationType                "master" \
    -negotiateMasterSlave           true

$Ethernet_1 config \
    -advertise10Full                true \
    -name                            "Ethernet-1" \
    -autoNegotiate                  true \
    -advertise100Half              true \
    -advertise10Half                true \
    -speed                          "k100FD" \
    -advertise1000Full              true \
    -advertise100Full               true \
    -cardElm

$my_ixNetEthernetELMPlugin

$Ethernet_1 childrenList.clear

set MAC_VLAN_2 [::IxLoad new ixNetL2EthernetPlugin]
# ixNet objects needs to be added in the list
# before they are configured!
$Ethernet_1 childrenList.appendItem -object $MAC_VLAN_2

$MAC_VLAN_2 config \
    -name                            "MAC/VLAN-2"

$MAC_VLAN_2 childrenList.clear
```

Configure the Dynamic Control plane settings.

Configure the physical layer properties.

Configure the MAC addresses and VLAN tags.



```

set Settings [::IxLoad new ixNetIxLoadSettingsPlugin]
# ixNet objects needs to be added in the list
# before they are configured!
$Network1 globalPlugins.appendItem -object $Settings

$Settings config \
    -teardownInterfaceWithUser      false \
    -name                            "Settings" \
    -interfaceBehavior              0

set Ethernet_1 [$Network1 getL1Plugin]

set my_ixNetEthernetELMPlugin [::IxLoad new ixNetEthernetELMPlugin]
$my_ixNetEthernetELMPlugin config \
    -negotiationType                "master" \
    -negotiateMasterSlave           true

$Ethernet_1 config \
    -advertise10Full                 true \
    -name                            "Ethernet-1" \
    -autoNegotiate                   true \
    -advertise100Half                true \
    -advertise10Half                 true \
    -speed                           "k100FD" \
    -advertise1000Full               true \
    -advertise100Full                true \
    -cardElm

$my_ixNetEthernetELMPlugin

$Ethernet_1 childrenList.clear

set MAC_VLAN_2 [::IxLoad new ixNetL2EthernetPlugin]
# ixNet objects needs to be added in the list
# before they are configured!
$Ethernet_1 childrenList.appendItem -object $MAC_VLAN_2

$MAC_VLAN_2 config \
    -name                            "MAC/VLAN-2"

$MAC_VLAN_2 childrenList.clear

```

Configure the Dynamic Control plane settings.

Configure the physical layer properties.

Configure the MAC addresses and VLAN tags.

```

set Emulated_Router_1 [::IxLoad new ixNetEmulatedRouterPlugin]
# ixNet objects needs to be added in the
# list before they are configured!
$MAC_VLAN_2 childrenList.appendItem -object $Emulated_Router_1

$Emulated_Router_1 config \
    -name "Emulated Router-1"

$Emulated_Router_1 childrenList.clear
$Emulated_Router_1 extensionList.clear
$MAC_VLAN_2 extensionList.clear
$Ethernet_1 extensionList.clear

#####
# Setting the ranges starting with the plugin on top of the stack
#####
$Emulated_Router_1 rangeList.clear

set ER_R1 [::IxLoad new ixNetEmulatedRouterRange]
# ixNet objects needs to be added in the list
# before they are configured!
$Emulated_Router_1 rangeList.appendItem -object $ER_R1

$ER_R1 config \
    -count 1 \
    -name "ER-R1" \
    -gatewayAddress "0.0.0.0" \
    -enabled true \
    -autoMacGeneration true \
    -mss 1460 \
    -incrementBy "0.0.0.1" \
    -prefix 16 \
    -gatewayIncrement "0.0.0.0" \
    -gatewayIncrementMode "perSubnet" \
    -generateStatistics false \
    -ipAddress "10.10.0.3" \
    -ipType "IPv4"

```

Configure an Emulated Router plugin.

Clear the lists of protocol extensions.

Configure an address range for the Emulated Router.

## IP Plugin

This section describes the IP protocol plugin.

## Port Group Data

### SYNOPSIS

### DESCRIPTION

Options for IP ranges within a specific port group.

### SUBCOMMANDS

### OPTIONS

`activityID`

Activity ID.

Default value = "0"

`activities`

List of activities.

Default Value = "None"

### EXAMPLE

### SEE ALSO

## IP Session Data

### SYNOPSIS

### DESCRIPTION

Configures the IP global settings.

## SUBCOMMANDS

### OPTIONS

Same as `SessionSpecificData` plus the following:

`duplicateCheckingScope`

Value used to scope of check to determine whether IP is unique within the session, within the port group, or disabled.

Value	Description
0	Disabled
1	Port Group
2	Session

Default value="None"

### EXAMPLE

### SEE ALSO

## IPv4V6Plugin

### SYNOPSIS

### DESCRIPTION

Layer 3 plugin that provides IPv4/IPv6 address ranges.

### SUBCOMMANDS

## OPTIONS

From `IpStaticProvider`:

`name`

Name of the instance of the plugin.

Default value = "None"

`childrenList`

Name of the list of next-lower layer plugins.

Default value = "None"

`extensionList`

Name of the list of protocol extensions.

Default value = "None"

`rangeList`

Name of the IP range. This parameter is read-only. Default value="None".

## EXAMPLE

```

set IP_2 [::IxLoad new ixNetIpV4V6Plugin]
# ixNet objects needs to be added in the list before they are configured!
$MAC_VLAN_7 childrenList.appendItem -object $IP_2

$IP_2 config \
-name                "IP-2"

$IP_2 childrenList.clear

$IP_2 extensionList.clear

$MAC_VLAN_7 extensionList.clear

$Ethernet_1 extensionList.clear

```

## **SEE ALSO**

### **IP Plugin Example**

This section shows an example of how to create a IP plugin in the Tcl API.

```

set TCP [::IxLoad new ixNetTCPPlugin]
# ixNet objects needs to be added in the list
# before they are configured!
$Network1 globalPlugins.appendItem -object $TCP

$TCP config \
    -tcp_bic 0 \
    -tcp_tw_recycle true \
    -tcp_retries2 5 \
    -tcp_retries1 3 \
    -tcp_keepalive_time 75 \
    -tcp_moderate_rcvbuf 0 \
    -tcp_rfc1337 false \
    -tcp_ipfrag_time 30 \
    -tcp_rto_max 60000 \
    -tcp_vegas_alpha 2 \
    -tcp_ecn false \
    -tcp_westwood 0 \
    -tcp_rto_min 1000 \
    -tcp_reordering 3 \
    -tcp_vegas_cong_avoid 0 \
    -tcp_keepalive_intvl 7200 \
    -tcp_rmem_max 262144 \
    -tcp_orphan_retries 0 \
    -tcp_max_tw_buckets 180000 \
    -tcp_wmem_default 4096 \
    -tcp_low_latency 0 \
    -tcp_rmem_min 4096 \
    -tcp_adv_win_scale 2 \
    -tcp_wmem_min 4096 \
    -tcp_port_min 1024 \
    -tcp_stdurg false \
    -tcp_port_max 65535 \
    -tcp_fin_timeout 60 \
    -tcp_no_metrics_save false \
    -tcp_dsack true \
    -tcp_mem_high 49152 \
    -tcp_frto 0 \
    -tcp_app_win 31 \
    -ip_no_pmtu_disc false \
    -tcp_window_scaling false \
    -tcp_max_orphans 8192 \
    -tcp_mem_pressure 32768 \
    -tcp_syn_retries 5 \

```

Configure the TCP  
portion of the stack.

```

set Settings [::IxLoad new ixNetIxLoadSettingsPlugin]
# ixNet objects needs to be added in the
# list before they are configured!
$Network1 globalPlugins.appendItem -object $Settings

$Settings config \
    -teardownInterfaceWithUser      false \
    -name                            "Settings" \
    -interfaceBehavior              0

set Ethernet_1 [$Network1 getL1Plugin]

set my_ixNetEthernetELMPlugin [::IxLoad new
ixNetEthernetELMPlugin]
$my_ixNetEthernetELMPlugin config \
    -negotiationType                "master" \
    -negotiateMasterSlave           true

$Ethernet_1 config \
    -advertise10Full                true \
    -name                            "Ethernet-1" \
    -autoNegotiate                  true \
    -advertise100Half               true \
    -advertise10Half                true \
    -speed                          "k100FD" \
    -advertise1000Full              true \
    -advertise100Full               true \
    -cardElm

$my_ixNetEthernetELMPlugin

$Ethernet_1 childrenList.clear

set MAC_VLAN_2 [::IxLoad new ixNetL2EthernetPlugin]
# ixNet objects needs to be added in the list
# before they are configured!
$Ethernet_1 childrenList.appendItem -object $MAC_VLAN_2

$MAC_VLAN_2 config \
    -name                            "MAC/VLAN-2"

$MAC_VLAN_2 childrenList.clear

```

Configure the Dynamic  
Control plane settings.

Configure the physical  
layer properties.

Configure the MAC  
addresses and VLAN tags.



```

set IP_3 [::IxLoad new ixNetIpV4V6Plugin]
# ixNet objects needs to be added in the list
# before they are configured!
$MAC_VLAN_2 childrenList.appendItem -object $IP_3

$IP_3 config \
    -name                "IP-3"

$IP_3 childrenList.clear
Clear the lists of
extension protocols.

$IP_3 extensionList.clear

$MAC_VLAN_2 extensionList.clear

$Ethernet_1 extensionList.clear

#####
# Setting the ranges starting with the plugin on top of the stack
#####
$IP_3 rangeList.clear

set IP_R3 [::IxLoad new ixNetIpV4V6Range]
# ixNet objects needs to be added in the
# list before they are configured!
Configure an IP
address range.
$IP_3 rangeList.appendItem -object $IP_R3

$IP_R3 config \
    -count                1 \
    -name                 "IP-R3" \
    -gatewayAddress       "0.0.0.0" \
    -enabled               true \
    -autoMacGeneration    true \
    -mss                   1460 \
    -incrementBy          "0.0.0.1" \
    -prefix                16 \
    -gatewayIncrement     "0.0.0.0" \
    -gatewayIncrementMode "perSubnet" \
    -generateStatistics   false \
    -ipAddress             "10.10.0.4" \
    -ipType                "IPv4"

```

```

set IP_3 [::IxLoad new ixNetIpV4V6Plugin]
# ixNet objects needs to be added in the list
# before they are configured!
$MAC_VLAN_2 childrenList.appendItem -object $IP_3

$IP_3 config \
    -name                                "IP-3"

$IP_3 childrenList.clear
$IP_3 extensionList.clear

$MAC_VLAN_2 extensionList.clear

$Ethernet_1 extensionList.clear

#####
# Setting the ranges starting with the plugin on top of the stack
#####
$IP_3 rangeList.clear

set IP_R3 [::IxLoad new ixNetIpV4V6Range]
# ixNet objects needs to be added in the
# list before they are configured!
$IP_3 rangeList.appendItem -object $IP_R3

$IP_R3 config \
    -count                                1 \
    -name                                "IP-R3" \
    -gatewayAddress                       "0.0.0.0" \
    -enabled                              true \
    -autoMacGeneration                    true \
    -mss                                  1460 \
    -incrementBy                          "0.0.0.1" \
    -prefix                               16 \
    -gatewayIncrement                     "0.0.0.0" \
    -gatewayIncrementMode                  "perSubnet" \
    -generateStatistics                    false \
    -ipAddress                             "10.10.0.4" \
    -ipType                               "IPv4"

```

Clear the lists of  
extension protocols.

Configure an IP  
address range.

```

set MAC_R2 [${IP_R3 getLowerRelatedRange "MacRange"}]

${MAC_R2 config \
  -count 1 \
  -name "MAC-R2" \
  -enabled true \
  -mtu 1500 \
  -mac "00:0A:0A:00:04:00" \
  -incrementBy "00:00:00:00:00:01"

set VLAN_R1 [${IP_R3 getLowerRelatedRange "VlanIdRange"}]

${VLAN_R1 config \
  -incrementStep 1 \
  -uniqueCount 4094 \
  -name "VLAN-R1" \
  -innerIncrement 1 \
  -innerUniqueCount 4094 \
  -enabled true \
  -innerFirstId 1 \
  -increment 1 \
  -priority 1 \
  -firstId 1 \
  -innerIncrementStep 1 \
  -idIncrMode 2 \
  -innerEnable false \
  -innerPriority 1

```

Configure the MAC addresses for the IP range.

Configure the VLAN tags for the IP range.

## StaticARP

This section describes the StaticARP plugin.

### SYNOPSIS

```
set StaticArpRange_2 [${IP_R4 getExtensionRange ${Static_ARP_2}]
```

```
${StaticArpRange_2 config \
```

### DESCRIPTION

Configures a StaticARP range. A StaticARP range is an extension to an IP range.

## SUBCOMMANDS

The options for this command are configured and read using the standard `config`, `cget`, and `getOption` subcommands defined in the `ixConfig` command.

## OPTIONS

`enabled`

If enabled, the Static ARP range is enabled for use in the configuration.

If disabled, the range will not be validated, nor will it be configured.

Static ARP ranges are enabled by default.

API Default = true

`mac`

The base value that the plug-in uses to create a range of MAC addresses for the static ARP table.

The default value is `aa:bb:cc:00:00:00`.

API Default = "aa:bb:cc:00:00:00"

`macIncrementBy`

The increment value that the plug-in uses to create a range of MAC addresses for the static ARP table.

The default value is `00:00:00:00:00:01`.

API Default = "00:00:00:00:00:01"

## EXAMPLE

```
set StaticArpRange_2 [$IP_R4 getExtensionRange $Static_ARP_2]
```

```
$StaticArpRange_2 config \
```

```
-macIncrementBy          "00:00:00:00:00:01" \
```

```
-mac                    "aa:bb:cc:00:00:00" \
```

```
-enabled                true
```

## DHCP Client and Server

This section describes the DHCP client and server plugins.

---

## DHCP Client Plugin

### SYNOPSIS

### DESCRIPTION

DHCP client.

### SUBCOMMANDS

### OPTIONS

`name`

Name of the instance of the plugin.

Default value = "None"

`childrenList`

Name of the list of next-lower layer plugins.

Default value = "None"

`extensionList`

Name of the list of protocol extensions.

Default value = "None"

`rangeList`

List of DHCP ranges. New elements can be added to the using `appendItem`. The elements of the list can be modified, but the list cannot be replaced.

Default value="None".

### EXAMPLE

```
set DHCP_Client_1 [::IxLoad new ixNetDHCPPlugin]
# ixNet objects needs to be added in the list before they are configured!
$MAC_VLAN_3 childrenList.appendItem -object $DHCP_Client_1

$DHCP_Client_1 config \
```

-name "DHCP Client-1"

\$DHCP\_Client\_1 childrenList.clear

\$DHCP\_Client\_1 extensionList.clear

\$MAC\_VLAN\_3 extensionList.clear

\$Ethernet\_1 extensionList.clear

## SEE ALSO

## DHCP Server Plugin

### SYNOPSIS

### DESCRIPTION

Configures a DHCP server.

### SUBCOMMANDS

### OPTIONS

name

Name of the instance of the plugin.

Default value = "None"

childrenList

Name of the list of next-lower layer plugins.

Default value = "None"

---

extensionList

Name of the list of protocol extensions.

Default value = "None"

rangeList

Name of the list of DHCP Server ranges.

Default value = "None"

### EXAMPLE

```
set DHCP_Server_1 [::IxLoad new ixNetDHCPServerPlugin]
# ixNet objects needs to be added in the list before they are configured!
$MAC_VLAN_4 childrenList.appendItem -object $DHCP_Server_1

$DHCP_Server_1 config \
-name                "DHCP Server-1"

$DHCP_Server_1 childrenList.clear

$DHCP_Server_1 extensionList.clear

$MAC_VLAN_4 extensionList.clear

$Ethernet_1 extensionList.clear
```

### SEE ALSO

## Authentication Extension Plugins

This section describes the Authentication Extension plugins.

## WebAuthPlugin

### SYNOPSIS

### DESCRIPTION

Configures a WebAuthx plugin.

### SUBCOMMANDS

### OPTIONS

`name`

Name of the instance of this plugin.

`rangeList`

List of address ranges used by this plugin.

Default value = "None"

### EXAMPLE

### SEE ALSO

## 802.1x plugin

### SYNOPSIS

### DESCRIPTION

Creates a range of names and passwords for use in a `Dot1xRangeList` object.



## SUBCOMMANDS

### OPTIONS

`name`

Name of the instance of the plugin.

Default value = "None"

`enabled`

If `True`, the plugin is enabled.

Default value="True".

`nacSequence`

The NAC Sequence used by this range.

**Note:** If a NAC Sequence has been selected for an 802.1X range, but you do not want a NAC Sequence associated with the range, specify `None` to remove the NAC Sequence from the range configuration.

Default value = "None"

`fastProvisionMode`

FAST provisioning mode specifies how the tunnel PAC is acquired.

Value	Description
authenticated	Authenticated (certificate is required). PAC provisioning occurs inside an authenticated tunnel, using the server certificate.
unauthenticated	Unauthenticated (no certificate required). When using unauthenticated mode, the first session will acquire a special token named <i>tunnelPac</i> from the ACS server. By design, the server will send a plain EAP Failure message at the end of the successful session. The ACS logs will indicate for the failed session that the client was provisioned with a new tunnelPac. IxLoad will not re-initiate a new session with the obtained tunnelPac unless the DUT re-initiates full re-authentication or a new start test message is sent to the PCPU.

fromfile	<p>Load from File</p> <p>A PAC is stored on the chassis. The share location is C:\Program Files\ixia\nfs\rw\ports\_x\_y_\</p> <p>In this mode, the PAC file is loaded from the file and is directly presented to server. The client does not request a new PAC as part of its session. Phase 0 (provisioning) is skipped.</p>
auth_save_pac	<p>Authenticated and save to file</p> <p>This option is identical to the Authenticated option except that after receiving a tunnel PAC, the client saves it on the Ixia chassis share C:\Program Files\ixia\nfs\rw\ports\_x\_y_\</p> <p>Note that any existing PACs will be overwritten.</p>
unauth_save_pac	<p>This option is identical to the Unauthenticated option except that after receiving a tunnel PAC, the client saves it on the Ixia chassis share C:\Program Files\ixia\nfs\rw\ports\_x\_y_\</p> <p>Note that any existing PACs will be overwritten.</p>

Default value="unauthenticated"

fastInnerMethod

FAST inner method.

Value	Description
GTC	GTC
MsChapv2	MS CHAP v2

Default value = "GTC"

fastStatelessResume

FAST stateless resume mode.

Value	Description
yes	Yes: Within the secure tunnel established between the client and the server, based on the tunnel PAC, the client also requires a UserPAC which will be provided by the server (if it is enabled to do so). If the client is provided with the UserPAC, during the next authentication sessions, it will have to send the userPAC to the server, within the tunnel, for the authentication to complete.
no	No: FAST stateless resume mode is not used.

Default value="no"

userName

The UserName used to authenticate the port.

Default value = "username\_1\_1\_1\_file"

userPassword

The User Password used to authenticate the port.

Default value = "userpass\_1\_1\_1\_file"

waitId

defaultValue="False"

protocol

The Authentication Protocol that this 802.1X range will use.

The choices are:

- TLS
- PEAPv0
- PEAPv1
- MD5
- TTLS
- FAST

When you choose FAST as the protocol, you need to also configure three more options (described below): FAST Provisioning, FAST Inner Method, and FAST Stateless.

defaultValue="MD5"

hostAuthMode

Host (Machine) Authentication Method that this 802.1X range will use.

Parameter	Description
None	None – No machine account is used.
HOST-ONLY	Host Only – When this mode is used, the Ixia port emulates only the host for each MAC address (but not the user). Nonetheless, the username certificate will be requested and transferred to the chassis.

HOST-USER-REAUTH	Host User-Reauth – When this mode is used, the Ixia port emulates both the host and the user for each MAC address. This emulates a case in which a domain machine that is started, the domain policies are applied (machine authentication), and multiple users then successfully log in. For each host/user pair, the host is authenticated first, followed by the user. Note that for user authentication to take place, the DUT must re-trigger authentication.
HOST-USER-BOTH	Host User-Both – When this mode is used, the Ixia port emulates both the host and the user for each MAC address. This emulates a case in which a domain machine is started, a domain policy is deployed, a user logs in, then a reboot occurs; the reboot starts the cycle again.

```
defaultValue="None"
```

```
hostName
```

The Machine Name used to authenticate the port.

```
defaultValue="hostname_1_1_1_file" />
```

```
hostPassword
```

The Machine Password used to authenticate the port.

```
defaultValue="hostpass_1_1_1_file" />
```

## EXAMPLE

## SEE ALSO

## EAPoUDP plugin

### SYNOPSIS

### DESCRIPTION

Configures the EAPoUDP Range Parameters.

### SUBCOMMANDS

## OPTIONS

name

Name of the instance of the plugin.

Default value = "None"

enabled

If `True`, the range base is enabled.

Default value="True".

nacSequence

The NAC Sequence used by this range.

**Note:** If a NAC Sequence has been selected for an 802.1X range, but you do not want a NAC Sequence associated with the range, specify `None` to remove the NAC Sequence from the range configuration.

Default value = "None"

fastProvisionMode

FAST provisioning mode specifies how the tunnel PAC is acquired.

Value	Description
authenticated	Authenticated (certificate is required). PAC provisioning occurs inside an authenticated tunnel, using the server certificate.
unauthenticated	Unauthenticated (no certificate required). When using unauthenticated mode, the first session will acquire a special token named <i>tunnelPac</i> from the ACS server. By design, the server will send a plain EAP Failure message at the end of the successful session. The ACS logs will indicate for the failed session that the client was provisioned with a new tunnelPac. IxLoad will not re-initiate a new session with the obtained tunnelPac unless the DUT re-initiates full re-authentication or a new start test message is sent to the PCPU.
fromfile	Load from File A PAC is stored on the chassis. The share location is C:\Program Files\ixia\nfs\rw\ports\_x\_y\ In this mode, the PAC file is loaded from the file and is directly presented to server. The client does not request a new PAC as part of its session. Phase 0 (provisioning) is skipped.

auth_save_pac	Authenticated and save to file This option is identical to the Authenticated option except that after receiving a tunnel PAC, the client saves it on the Ixia chassis share C:\Program Files\ixia\nfs\rw\ports\_x\_y\ Note that any existing PACs will be overwritten.
unauth_save_pac	This option is identical to the Unauthenticated option except that after receiving a tunnel PAC, the client saves it on the Ixia chassis share C:\Program Files\ixia\nfs\rw\ports\_x\_y\ Note that any existing PACs will be overwritten.

Default value="unauthenticated"

fastInnerMethod

FAST inner method.

Value	Description
GTC	GTC
MsChapv2	MS CHAP v2

Default value = "GTC"

fastStatelessResume

FAST stateless resume mode.

Value	Description
yes	Yes: Within the secure tunnel established between the client and the server, based on the tunnel PAC, the client also requires a UserPAC which will be provided by the server (if it is enabled to do so). If the client is provided with the UserPAC, during the next authentication sessions, it will have to send the userPAC to the server, within the tunnel, for the authentication to complete.
no	No: FAST stateless resume mode is not used.

Default value="no"

userName

The UserName used to authenticate the port.

Default value = "username\_1\_1\_1\_file"

userPassword

The User Password used to authenticate the port.

Default value = "userpass\_1\_1\_1\_file"

protocol

The Authentication Protocol that this EAPoUDP range will use. The choices are:

- PEAPv1
- FAST

When you choose FAST as the protocol, you need to also configure three more options: Fast Provisioning, Fast Inner Method, and Fast Stateless.

Default value = "PEAPv1"

responseType

The types of EAPoUDP messages to which the range responds.

Value	Description
RespondToAll	Respond To All – Respond to all EAPoUDP messages.
NoStatusQuery	No Status Query – Do not respond to EAP-StatusQuery messages. The lack of a response to these messages triggers a new full authorization exchange.
IgnoreAll	Ignore All – Do not respond to any EAPoUDP messages. This simulates a non-responsive host.

Default value = "RespondToAll"

expectedSystemToken

The expected system token.

Value	Description
0	Healthy
10	Checkup
15	Transition
20	Quarantine
30	Infected
100	Unknown

Default value = "0; 10; 15; 20; 30; 100"

## EXAMPLE

## SEE ALSO

# Impair Plugin

## SYNOPSIS

## DESCRIPTION

Defines an Impair plugin.

## SUBCOMMANDS

## OPTIONS

name

Name of the instance of the plugin.

Default value = "None"

rangeList

Name of the Impair range.

Default value = "None"

## EXAMPLE

```
set Impair_1 [::IxLoad new ixNetImpairPlugin]
# ixNet objects needs to be added in the list before they are configured!
$IP_5 extensionList.appendItem -object $Impair_1

$Impair_1 config \
-name                "Impair-1"
```



```
$MAC_VLAN_11 extensionList.clear
```

```
$Ethernet_1 extensionList.clear
```

## SEE ALSO

# ImpairRange

## SYNOPSIS

## DESCRIPTION

Defines the properties of the Impair range. Configure the ranges as a list.

## SUBCOMMANDS

## OPTIONS

name

Name of the instance of the plugin.

Default value = "None"

enabled

If `True`, the range base is enabled.

Default value="True".

targetRange

The name of the target IP range.

Default value = "None"

profile

The name of the `ImpairProfile` object that contains the impairment settings used by this range.

defaultValue="None"

## EXAMPLE

```
$IP_5 rangeList.clear
```

```
set IP_R5 [::IxLoad new ixNetIpV4V6Range]# ixNet objects needs to be added in the
list before they are configured!$IP_5 rangeList.appendItem -object $IP_R5
```

```
$IP_R5 config \-count 1 \-name
"IP-R5" \-gatewayAddress "0.0.0.0" \-enabled
true \-autoMacGeneration true \-mss
1460 \-incrementBy "0.0.0.1" \-prefix
16 \-gatewayIncrement "0.0.0.0" \-gatewayIncrementMode
"perSubnet" \-generateStatistics false \-ipAddress
"10.10.0.6" \-ipType "IPv4"
```

```
set Impair_R1 [$IP_R5 getExtensionRange $Impair_1]
```

```
set DefaultProfile [::IxLoad new ixNetImpairProfile]$DefaultProfile config \-
addTcpFlagsFilter false \-jitter
0 \-reorderPISkip 1 \-seed
0 \-typeOfService "any" \-dropSequenceLength
1 \-protocol "any" \-addFragment
false \-addBandwidth false \-delay
1 \-addDelay true \-impairOrder
"Delay;Drop;DropSeq;Reorder;ReorderPI;Duplicate;Fragment;FragmentSeq;Bandwidth" \-
sendFirstFragmentOnly false \-addDrop
false \-reorderLength 1 \-addDuplicate
false \-reorderPILength 1 \-sendOverlappingFragments
false \-reorderPITimeout 1000 \-addReorderPI
false \-reorder 1 \-addFragmentSequence
false \-expectTcpFlags "SYN" \-destinationIp
"any" \-fragmentSequenceSkip 1 \-addBandwidthIn
false \-selectTcpFlags "SYN;RST;ACK" \-gap
1 \-destinationPort 0 \-fragmentSequenceLength
1 \-sourcePort 0 \-bandwidthUnitsIn
"kbps" \-name "DefaultProfile" \-mtuSequence
1000 \-dropSequenceSkip 1 \-mtu
1000 \-addReorder false \-defaultp
true \-bandwidthUnits "kbps" \-reorderPIInterval
1 \-sourceIp "any" \-sendFragmentsInReverseOrder
false \-addDropSequence false
```

```
$Impair_R1 config \-enabled true \-name
"Impair-R1" \-profile $DefaultProfile
```

```
set MAC_R10 [$IP_R5 getLowerRelatedRange "MacRange"]
```

```

$MAC_R10 config \-count 1 \-name
"MAC-R10" \-enabled true \-mtu
1500 \-mac "00:0A:0A:00:06:00" \-incrementBy
"00:00:00:00:00:01"

```

```
set VLAN_R1 [$IP_R5 getLowerRelatedRange "VlanIdRange"]
```

```

$VLAN_R1 config \-incrementStep 1 \-uniqueCount
4094 \-name "VLAN-R1" \-innerIncrement
1 \-innerUniqueCount 4094 \-enabled
true \-innerFirstId 1 \-increment
1 \-priority 1 \-firstId
1 \-innerIncrementStep 1 \-idIncrMode
2 \

-innerEnable false \
-innerPriority 1

```

## SEE ALSO

## ImpairProfile

### SYNOPSIS

### DESCRIPTION

Defines a new impairment profile. Configure the profiles as a list.

### SUBCOMMANDS

### OPTIONS

#### General parameters

name

Name of this profile.

Default value = "None"

defaultTp

Set to True to make this the default profile. When True, this profile is assigned to new impair ranges.

Default value = "False"

### Delay parameters

addDelay

If `true`, this impairment is applied to the packet stream.

Default value = "True"

delay

The *Delay* impairment characteristic allows you to insert latency errors into a packet stream.

Specifies the delay for each packet, in milliseconds.

Default value = "1"

jitter

Specifies the jitter value, in milliseconds.

A random value from 0 ms to the Jitter value that you specify is added to or subtracted from your specified *Delay* value. Note that the Jitter value cannot be greater than `delay`.

Default value = "0"

### Drop parameters

addDrop

The *Drop* impairment characteristic allows you emulate random packet loss from a packet stream.

If `true`, this impairment is applied to the packet stream.

Default value = "False"

### Drop Sequence parameters

addDropSequence

The *Drop Sequence* impairment characteristic allows you emulate sequential packet loss from a packet stream. In this case, a specified number of packets will be dropped at a specified interval.

If `true`, this impairment is applied to the packet stream.

Default value = "False"

dropSequenceSkip

The number of packets that will be transmitted before one or more packets are dropped.

Default value = "1"

`dropSequenceLength`

The number of packets that will be dropped.

The Drop Sequence setting specifies that a sequence of  $d$  packets is dropped after each transmitted sequence of  $s$  packets.

For example, if  $s = 2$  and  $d = 3$ , the transmitted packets are:

1, 2, 6, 7, 11, 12, 16, 17, 21, 22.

Default value = "1"

## Reorder parameters

`addReorder`

The *Reorder* impairment characteristic allows you emulate packet reordering based on a time delay. In this case, because some packets are delayed during transmission, they arrive out of order in the packet stream. The delay pattern repeats after a specified number of packets (number of packets skipped plus the number of packets delayed) have been sent.

If `true`, this impairment is applied to the packet stream.

Default value = "False"

`gap`

Specifies the number of packets to skip before reordering packet.

Default value = "1"

`reorder`

Specifies how long the packets are to be delayed (number of milliseconds).

Default value = "20"

`reorderLength`

Specifies the number of consecutive packets to reorder.

Default value = "1"

## Reorder Sequence parameters

`addReorderPI`

The *Reorder Sequence* impairment characteristic allows you emulate delay caused by packet reordering. In this form of impairment, packets are delayed during transmission by reordering the packet interval.

If `true`, this impairment is applied to the packet stream.

Default value = "False"

`reorderPISkip`

The number of packets ( $s$ ) to transmit prior to delaying the transmission of  $d$  packets.

Default value = "1"

`reorderPILength`

The number of packets ( $d$ ) to take out of the stream for delayed transmission.

Default value = "1"

`reorderPIInterval`

The number of packets ( $m$ ) to transmit before transmitting the  $d$  packets that were previously taken out of the stream.

Default value = "1"

`reorderPITimeout`

The maximum time that a packet may be delayed, specified in milliseconds.

Default value = "1000"

### Duplicate parameters

`addDuplicate`

The *Duplicate* impairment characteristic allows you emulate the appearance of duplicate packets in a packet stream. In this case, a specified percentage of packets will be duplicated.

If `true`, this impairment is applied to the packet stream.

Default value = "False"

`duplicate`

The percentage of packets to be duplicated.

### Fragment parameters

`addFragment`

The *Fragment* impairment characteristic allows you emulate various packet fragmentation scenarios.

If `true`, this impairment is applied to the packet stream.

Default value = "False"

`mtu`

The maximum transmission unit for packets that will be fragmented.

Default value = "1000"

---

`sendFragmentsInReverseOrder`

If `true`, transmit fragments in reverse order.

This setting allows testing of worst-case reassembly scenarios.

Default value = "False"

`sendFirstFragmentOnly`

If `true`, transmit only the first fragment of each datagram. All other fragments are discarded.

If you also select *Reverse Fragments*, only the fragment that would have been sent last is sent.

This feature allows you to test reassembly timeout mechanisms.

Default value = "False"

`sendOverlappingFragments`

If `true`, the IP stack creates and sends random, but legitimate, IP fragments whose data offset and length are randomly selected. In this case, that the receiving end detects overlapping data in the fragments it receives.

This setting is useful for testing reassembly mechanisms at the other end.

Default value = "False"

## Fragment Sequence parameters

`addFragmentSequence`

The *Fragment Sequence* impairment characteristic allows you to emulate various packet fragmentation scenarios. In this form of impairment, the packets selected for fragmentation are chosen based on a defined packet sequence.

If `true`, this impairment is applied to the packet stream.

Default value = "False"

`fragmentSequenceSkip`

The number of packets (*s*) to skip before fragmenting packets.

Default value = "1"

`fragmentSequenceLength`

The number of packets (*d*) to select from the stream for fragmentation.

Default value = "1"

`mtuSequence`

The maximum transmission unit for the packets that will be fragmented.

MTU defines the packet size after fragmentation. For example, if MTU=220, the Impair plug-in breaks a packet of 661 bytes into 4 fragments.

Default value = "1000"

`sendFragmentsInReverseOrder`

If `true`, transmit fragments in reverse order.

This setting allows testing of worst-case reassembly scenarios.

Default value = "False"

`sendFirstFragmentOnly`

If `true`, transmit only the first fragment of each datagram. All other fragments are discarded.

If you also select *Reverse Fragments*, only the fragment that would have been sent last is sent.

This feature allows you to test reassembly timeout mechanisms.

Default value = "False"

`sendOverlappingFragments`

If `true`, the IP stack creates and sends random, but legitimate, IP fragments whose data offset and length are randomly selected. In this case, that the receiving end detects overlapping data in the fragments it receives.

This setting is useful for testing reassembly mechanisms at the other end.

Default value = "False"

## Outbound Rate parameters

`addBandwidth`

Adds an impairment characteristic to the outbound traffic that allows you to limit egress traffic speed, and thereby simulate a lower bandwidth network.

Default value = "False"

`bandwidthUnits`

The bandwidth unit to use.

Value	Description
kbps	KByte/sec
kbit	KBit/sec



mbps	MByte/sec
mbit	MBit/sec

Default value = "kbps"

## Inbound Rate parameters

`addBandwidthIn`

Adds an impairment characteristic to the inbound traffic that allows you to limit ingress traffic speed, and thereby simulate a lower bandwidth network.

Default value = "False"

`bandwidthUnitsIn`

The bandwidth unit to use.

Value	Description
kbps	KByte/sec
kbit	KBit/sec
mbps	MByte/sec
mbit	MBit/sec

Default value = "kbps"

## Packets to Impair parameters

`destinationIp`

A destination IP address and prefix on which to filter.

Impairment will be applied only on packets targeted to this destination.

You can specify a host address (such as 192.168.85.10/32) or a network address (such as 192.168.85.0/24).

You can also specify IPv6 addresses, both in the long form (such as 2008:0007:0031:0000:0000:0000:0001/64), or in the short form (such as 2008:7:31::1/64).

The default value is *any* address (in which case, all packets are impaired).

Default value = "any"

`sourceIp`

A source IP address and prefix on which to filter.

Impairment will be applied only on packets received from the specified source.

You can specify a host address (such as 192.168.85.10/32) or a network address (such as 192.168.85.0/24).

You can also specify IPv6 addresses, both in the long form (such as 2008:0007:0031:0000:0000:0000:0000:0001/64), or in the short form (such as 2008:7:31::1/64).

The default value is *any* address (in which case, all packets are impaired).

Default value = "any"

`sourcePort`

The source port number on which to filter.

Impairment will be applied to only those packets that have this source port number.

The default value is zero (in which case, all packets are impaired).

Default value = "0"

`destinationPort`

The destination port number on which to filter.

Impairment will be applied to only those packets that have this destination port number.

The default value is zero (in which case, all packets are impaired).

Default value = "0"

`protocol`

The type of protocol to which the impairment will be applied:

- any – all protocols
- ICMP
- TCP
- UDP
- ICMPv6

The default value is *any* protocol (in which case, all packets are impaired).

Default value = "any"

`typeOfService`

Indicates the Type of Service to which the impairment will be applied:

- any – all TOS
- Minimum Cost (0x02)
- Maximum Reliability (0x04)

- Maximum Throughput (0x08)
- Minimum Delay (0x10)
- Class 1 (0x20)
- Class 2 (0x40)
- Class 3 (0x60)
- Class 4 (0x80)
- Express Forwarding (0xA0)
- Control (0xC0)

You can also manually enter any custom TOS value (between 0x00 – 0xFF, or between 0 – 255).

The default value is *any* TOS value (in which case, all packets are impaired).

Default value = "any"

`addTcpFlagsFilter`

If `true`, impairment will be applied to only those TCP packets having specific TCP flags set, as specified in the Select TCP Flags and Expect TCP Flags fields.

The default setting is Unchecked. Selecting this parameter enables the Select TCP Flags and Expect TCP Flags fields.

Default value = "False"

`selectTcpFlags`

A comma-separated list of TCP flags to be examined on the packet.

Value	Description
SYN	SYN flag
ACK	ACK flag
FIN	FIN flag
RST	RST flag
URG	URG flag
PSH	PSH flag
ECE	ECE flag
CWR	CWR flag
ALL	All flags
NONE	No flags

Default value = "SYN;RST;ACK"

expectTcpFlags

A comma-separated list of TCP flags that must be set in the packet for that packet to be selected. See `selectTcpFlags` for the list of flags

Default value = "SYN"

impairOrder

A comma-separated list that defines the order that the impairments will be applied in.

Value	Description
Delay	Delay impairment
Drop	Drop impairment
DropSeq	Drop Sequence impairment
Reorder	Reorder impairment
ReorderPI	Reorder Sequence impairment
Duplicate	Duplicate impairment
Fragment	Fragment impairment
FragmentSeq	Fragment Sequence impairment
Bandwidth	Inbound / Outbound Rate impairment

Default value = "Delay;Drop;DropSeq;Reorder;ReorderPI;Duplicate;Fragment;FragmentSeq;Bandwidth"

**EXAMPLE**

```
set DefaultProfile [::IxLoad new ixNetImpairProfile]
$DefaultProfile config \
-addTcpFlagsFilter          false \
-jitter                     0 \
-reorderPISkip             1 \
-seed                      0 \
-typeOfService             "any" \
-dropSequenceLength        1 \
```

---

```
-protocol                "any" \  
-addFragment            false \  
-addBandwidth           false \  
-delay                  1 \  
-addDelay                true \  
-impairOrder            "Delay;Drop;DropSeq;Re-  
order;ReorderPI;Duplicate;Fragment;FragmentSeq;Bandwidth" \  
-sendFirstFragmentOnly  false \  
-addDrop                false \  
-reorderLength          1 \  
-addDuplicate           false \  
-reorderPILength        1 \  
-sendOverlappingFragments false \  
-reorderPITimeout       1000 \  
-addReorderPI           false \  
-reorder                1 \  
-addFragmentSequence    false \  
-expectTcpFlags         "SYN" \  
-destinationIp          "any" \  
-fragmentSequenceSkip   1 \  
-addBandwidthIn         false \  
-selectTcpFlags         "SYN;RST;ACK" \  
-gap                    1 \  
-destinationPort        0 \  
-fragmentSequenceLength 1 \  
-sourcePort             0 \  
-bandwidthUnitsIn       "kbps" \  
-name                   "DefaultProfile" \  
-mtuSequence            1000 \  
-dropSequenceSkip       1
```

```
-mtu                1000 \  
-addReorder        false \  
-defaultp          true \  
-bandwidthUnits    "kbps" \  
-reorderPIInterval 1 \  
-sourceIp          "any" \  
-sendFragmentsInReverseOrder false \  
-addDropSequence   false
```

## SEE ALSO

## Impair Plugin Example

This section shows an example of how to create an Impair plugin in the Tcl API.

## Impair Plugin Example

```
#####
# IxLoad ScriptGen created TCL script
# Network1 serialized using version 4.10.0.79
# Impair.tcl made on Aug 14 2008 15:31
#####

set Network1 [::IxLoad new ixNetworkGroup $chassisChain]
$Network1 config \
    -comment          "" \
    -name              "Network1" \
    -macMappingMode   0 \
    -linkLayerOptions 0

$Network1 globalPlugins.clear

Begin appending items to global plugin list.

set GratARP [::IxLoad new ixNetGratArpPlugin]
# ixNet objects needs to be added in the list
# before they are configured!
$Network1 globalPlugins.appendItem -object $GratARP

$GratARP config \
    -enabled          true \
    -name              "GratARP"
```

Create a network group.

Clear the global plugins list.

Begin appending items to global plugin list.

Optionally, enable  
Gratuitous ARP.

```

set TCP [::IxLoad new ixNetTCPPlugin]
# ixNet objects needs to be added in the list
# before they are configured!
$Network1 globalPlugins.appendItem -object $TCP

```

Configure the TCP  
portion of the stack.

```

$TCP config \
  -tcp_bic 0 \
  -tcp_tw_recycle true \
  -tcp_retries2 5 \
  -tcp_retries1 3 \
  -tcp_keepalive_time 75 \
  -tcp_moderate_rcvbuf 0 \
  -tcp_rfc1337 false \
  -tcp_ipfrag_time 30 \
  -tcp_rto_max 60000 \
  -tcp_vegas_alpha 2 \
  -tcp_ecn false \
  -tcp_westwood 0 \
  -tcp_rto_min 1000 \
  -tcp_reordering 3 \
  -tcp_vegas_cong_avoid 0 \
  -tcp_keepalive_intvl 7200 \
  -tcp_rmem_max 262144 \
  -tcp_orphan_retries 0 \
  -tcp_max_tw_buckets 180000 \
  -tcp_wmem_default 4096 \
  -tcp_low_latency 0 \
  -tcp_rmem_min 4096 \
  -tcp_adv_win_scale 2 \
  -tcp_wmem_min 4096 \
  -tcp_port_min 1024 \
  -tcp_stdurg false \
  -tcp_port_max 65535 \
  -tcp_fin_timeout 60 \
  -tcp_no_metrics_save false \
  -tcp_dsack true \
  -tcp_mem_high 49152 \
  -tcp_frto 0 \
  -tcp_app_win 31 \
  -ip_no_pmtu_disc false \
  -tcp_window_scaling false \
  -name "TCP" \

```



```

set Settings [::IxLoad new ixNetIxLoadSettingsPlugin]
# ixNet objects needs to be added in the list
# before they are configured!
$Network1 globalPlugins.appendItem -object $Settings

$Settings config \
    -teardownInterfaceWithUser      false \
    -name                            "Settings" \
    -interfaceBehavior              0

set Ethernet_1 [$Network1 getL1Plugin]

set my_ixNetEthernetELMPlugin [::IxLoad new ixNetEthernetELMPlugin]
$my_ixNetEthernetELMPlugin config \
    -negotiationType                "master" \
    -negotiateMasterSlave           true

$Ethernet_1 config \
    -advertise10Full                true \
    -name                            "Ethernet-1" \
    -autoNegotiate                   true \
    -advertise100Half               true \
    -advertise10Half                true \
    -speed                           "k100FD" \
    -advertise1000Full              true \
    -advertise100Full               true \
    -cardElm

$my_ixNetEthernetELMPlugin

$Ethernet_1 childrenList.clear

```

Configure the Dynamic  
Control plane settings.

Configure the physical  
layer properties.

```
set MAC_VLAN_11 [::IxLoad new ixNetL2EthernetPlugin]
# ixNet objects needs to be added in the list
# before they are configured!
$Ethernet_1 childrenList.appendItem -object $MAC_VLAN_11

$MAC_VLAN_11 config \
    -name "MAC/VLAN-11"

$MAC_VLAN_11 childrenList.clear

set IP_5 [::IxLoad new ixNetIpV4V6Plugin]
# ixNet objects needs to be added in the
# list before they are configured!
$MAC_VLAN_11 childrenList.appendItem -object $IP_5

$IP_5 config \
    -name "IP-5"

$IP_5 childrenList.clear

$IP_5 extensionList.clear

set Impair_2 [::IxLoad new ixNetImpairPlugin]
# ixNet objects needs to be added in the list
# before they are configured!
$IP_5 extensionList.appendItem -object $Impair_2

$Impair_2 config \
    -name "Impair-2"

$MAC_VLAN_11 extensionList.clear
$Ethernet_1 extensionList.clear
```

Configure the MAC addresses and VLAN tags.

Create an IP range and append it to the MAC and VLAN ranges.

Create an Impair plugin and append it to the IP range as an extension protocol.

Clear the remaining lists of extension protocols.

```
#####
# Setting the ranges starting with the plugin on top of the stack
#####
$IP_5 rangeList.clear

set IP_R5 [::IxLoad new ixNetIpV4V6Range]
# ixNet objects needs to be added in the list before they are
# configured!
$IP_5 rangeList.appendItem -object $IP_R5

$IP_R5 config \
  -count                1 \
  -name                  "IP-R5" \
  -gatewayAddress        "0.0.0.0" \
  -enabled               true \
  -autoMacGeneration     true \
  -mss                   1460 \
  -incrementBy           "0.0.0.1" \
  -prefix                16 \
  -gatewayIncrement      "0.0.0.0" \
  -gatewayIncrementMode  "perSubnet" \
  -generateStatistics    false \
  -ipAddress              "10.10.0.6" \
  -ipType                "IPv4"

set Impair_R2 [$IP_R5 getExtensionRange $Impair_2]
```

Configure an address range  
and append it to the IP plugin.

Impair the address range by  
appending it as an extension protocol.

```

set DefaultProfile [::IxLoad new ixNetImpairProfile]
$DefaultProfile config \
    -addTcpFlagsFilter                false \
    -jitter                          0 \
    -reorderPISkip                    1 \
    -seed                             0 \
    -typeOfService                    "any" \
    -dropSequenceLength              1 \
    -protocol                         "any" \
    -addFragment                     false \
    -addBandwidth                    false \
    -delay                            1 \
    -addDelay                        true \
    -impairOrder
"Delay;Drop;DropSeq;Reorder;ReorderPI;Duplicate;Fragment;FragmentSe
q;Bandwidth" \
    -sendFirstFragmentOnly          false \
    -addDrop                        false \
    -reorderLength                  1 \
    -addDuplicate                    false \
    -reorderPILength                1 \
    -sendOverlappingFragments       false \
    -reorderPITimeout               1000 \
    -addReorderPI                   false \
    -reorder                        1 \
    -addFragmentSequence            false \
    -expectTcpFlags                 "SYN" \
    -destinationIp                  "any" \
    -fragmentSequenceSkip           1 \
    -addBandwidthIn                 false \
    -selectTcpFlags                 "SYN;RST;ACK" \
    -gap                            1 \
    -destinationPort                0 \
    -fragmentSequenceLength         1 \
    -sourcePort                     0 \
    -bandwidthUnitsIn               "kbps" \
    -name                            "DefaultProfile" \
    -mtuSequence                    1000 \
    -dropSequenceSkip               1 \
    -mtu                            1000 \
    -addReorder                     false \
    -defaultp                        true \
    -bandwidthUnits                 "kbps" \
    -reorderPIInterval              1 \
    -sourceIp                        "any" \
    -sendFragmentsInReverseOrder    false \
    -addDropSequence                false

```

Configure an Impair profile.

```

$Impair_R2 config \
  -enabled      true \
  -name         "Impair-R2" \
  -profile      $DefaultProfile

set MAC_R10 [$IP_R5 getLowerRelatedRange "MacRange"]

$MAC_R10 config \
  -count       1 \
  -name        "MAC-R10" \
  -enabled     true \
  -mtu         1500 \
  -mac         "00:0A:0A:00:06:00" \
  -incrementBy "00:00:00:00:00:01"

set VLAN_R1 [$IP_R5 getLowerRelatedRange "VlanIdRange"]

$VLAN_R1 config \
  -incrementStep 1 \
  -uniqueCount   4094 \
  -name          "VLAN-R1" \
  -innerIncrement 1 \
  -innerUniqueCount 4094 \
  -enabled       true \
  -innerFirstId  1 \
  -increment     1 \
  -priority      1 \
  -firstId       1 \
  -innerIncrementStep 1 \
  -idIncrMode    2 \
  -innerEnable   false \
  -innerPriority  1

```

Name the Impair profile.

Configure the MAC addresses for the IP range.

Configure the VLAN tags for the IP range.

## IPSec Plugin

### SYNOPSIS

### DESCRIPTION

Configures an IPSec plugin.

### SUBCOMMANDS

## OPTIONS

name

Name of the instance of the plugin.

Default value = "None"

childrenList

Name of the list of next-lower layer plugins.

Default value = "None"

extensionList

Name of the list of protocol extensions.

Default value = "None"

rangeList

Name of the list of ranges used by this plugin.

Default value = "None"

## EXAMPLE

```
set IPsec_1 [::IxLoad new ixNetIPSecPlugin]# ixNet objects needs to be added in the list before they are configured!  
$IP_3 childrenList.appendItem -object $IPsec_1
```

```
$IPsec_1 config \-name "IPsec-1"
```

```
$IPsec_1 childrenList.clear
```

```
$IPsec_1 extensionList.clear
```

```
$IP_3 extensionList.clear
```

```
$Emulated_Router_1 extensionList.clear
```

```
$MAC_VLAN_8 extensionList.clear
```

```
$Ethernet_1 extensionList.clear
```

## SEE ALSO

## IPSecRange

### SYNOPSIS

### DESCRIPTION

Creates an IPSec address range for addition to an `IPSecRangeList` object.

### SUBCOMMANDS

### OPTIONS

`name`

Name of the instance of the plugin.

Default value = "None"

`enabled`

If `True`, the range base is enabled.

Default value="True".

### Basic Parameters

`ikeVersion`

The keying protocol to be used for the tunnel negotiation phase:

- IKEv1: Use IKE version 1 to establish security associations between IPsec peers.
- IKEv2: Use IKE version 2 to establish security associations between IPsec peers.
- Manual: Use manual keying to configure the security policy options. In this case, you configure the keys in the Keys grid (refer to IPsec Range Parameters - Keys). Note that manual keying is not supported in Ixia port-to-port configurations.

The default is IKEv2.

**Note:** All ranges within a must be configured with the same *IKE Version* (IKEv1, IKEv2, or Manual).

Values= "ikev1", "ikev2", "manual", Default value = "ikev1"

`testScenario`

The type of IPsec test scenario for which you are defining this configuration:

- Site to Site: Two sites are connected through a pair of IPsec Secure Gateways. When this option is selected, the fields pertaining to Xauth and ModeCfg are disabled.
- Remote Access: An individual client is connected to a LAN through a secure tunnel. In this scenario, the client is operating as its own Secure Gateway. When this option is selected, the fields pertaining to Emulated Subnet are disabled.

The default is Site to Site.

Default value = "site2site"

ikeMode

Specifies the IKE (Internet Key Exchange) mode of communications for phase 1. The choices are:

- Main Mode - 6 messages exchanged with identity protection.
- Aggressive Mode - 3 messages exchanged without identity protection.

The default is Main Mode.

Default value = "main"

hashAlgoPhase1

Specifies the hashing algorithm to use for Phase 1. The choices are:

- HMAC-MD5: Message-Digest Algorithm 5.
- HMAC-SHA1: Secure Hash Algorithm 1.
- AES-XCBC: AUTH\_AES\_XCBC\_96 algorithm, defined in RFC3566. Supported by IKEv2 only.

The default is HMAC-MD5.

API values = "md5", "sha1", "aes-xcbc".

Default value = "md5"

dhGroup

Specifies the DH Group. The public-private cryptography used to create the shared secret uses an algorithm called Diffie-Hellman. DH Groups use different bit length selections in this calculation. The choices are:

- DH-1
- DH-2
- DH-5
- DH-14
- DH-15
- DH-16

The default is DH-2.

Default value = "dh2"

dpdIdlePeriod



The default value is 1000.

`encAlgoPhase1`

Specifies the encryption algorithm used to protect communications during phase 1 message exchange. The choices are:

- DES
- 3-DES
- AES-128
- AES-192
- AES-256

The default is 3-DES.

Default value = "3des"

`ahNespMode`

Specifies the AH (Authentication Header) and ESP (Encapsulating Security Payload) options. The choices are:

- AH Only
- ESP Only
- Both AH and ESP

The default is ESP Only.

Default value = "ESPOnly"

`encapMode`

Specifies the IKE phase 2 encapsulation mode. The choices are:

- Tunnel Mode
- Transport Mode

Note that in IxLoad tests using transport mode, the data traffic terminates in the DUT: the data is not forwarded to the protected hosts on the Ixia port.

API values = "tunnel", "transport".

Default value = "tunnel"

`hashAlgoPhase2`

Specifies the hashing algorithm to use for Phase 2. The choices are:

- HMAC-MD5
- HMAC-SHA1

The default is HMAC-MD5.

Default value = "md5"

encAlgoPhase2

Specifies the encryption algorithm used to protect communications during phase 1 and phase 2 message exchange. The choices are:

- Null
- DES
- 3-DES
- AES-128
- AES-192
- AES-256

The default is 3-DES.

Default value = "3des"

## EXAMPLE

```
$IPsec_R3 config \  
-psnIncrementBy          "0.0.1.0" \  
-singlePH                false \  
-numEHCount              1 \  
-psk                     "ipsec" \  
-enableNatt              false \  
-enabled                 true \  
-peerPublicIP            "1.1.1.1" \  
-dpdTimeout              10 \  
-ipsecIDTypeInitiator    "ip-addr-id" \  
-publishStats            false \  
-ikeMode                 "main" \  
-encAlgoPhase2           "3des" \  
-encAlgoPhase1           "3des" \  
-userGroups              false \  
-modeCfgAddressIncrement "0.0.0.1" \  
-xauth                   false \  

```

---

```
-modeCfgAddressSuffix      24 \  
-emulatedSubnetIpType     "IPv4" \  
-modeCfgFirstAddress      "30.0.0.1" \  
-ipsecIDTypeResponder     "ip-addr-id" \  
-modeCfg                  "none" \  
-ipCompression            false \  
-hashAlgoPhase1          "md5" \  
-protectedSubnet         "70.0.0.0" \  
-peerPublicIPType        "IPv4" \  
-groupName                "vpngroup" \  
-hashAlgoPhase2          "md5" \  
-pfsGroup                 "dh2" \  
-eapMethod                "md5" \  
-encapMode                "tunnel" \  
-ahNespMode               "ESPOnly" \  
-username                 "ipsec-username" \  
-ikeVersion                "ikev2" \  
-enablePFS                false \  
-initialContact           false \  
-emulatedSubnet          "40.0.0.0" \  
-authMethod               "eap" \  
-testScenario             "site2site" \  
-esnIncrementBy           "0.0.1.0" \  
-lifeTimePhase1           3600 \  
-lifeTimePhase2           28800 \  
-protectedSubnetSuffix    24 \  
-prfAlgo                  "md5" \  
-password                 "ipsec-pass" \  
-fqdnSeedInitiator        "" \  
-enableDPD                false \  

```

```
-emulatedSubnetSuffix      24 \  
-enableMultipleP2perP1     false \  
-dhGroup                   "dh2" \  
-dpdIdlePeriod             1000 \  
-fqdnSeedResponder        "" \  
-txPreFrag                 false \  
-manualKeyingOpts         $my_ixNetIPSecManualKeyingOpts
```

## SEE ALSO

## Network Config

### SYNOPSIS

### DESCRIPTION

Creates an IPSec address range for addition to an `IPSecRangeList` object.

### SUBCOMMANDS

### OPTIONS

`name`

Name of the instance of the plugin.

Default value = "None"

`enabled`

If `True`, the range base is enabled.

Default value="True".

`emulatedSubnetIpType`

Specifies the IP version to be used for the emulated subnets in the test:

- IPv4

- IPv6

Note that the IPsec plug-in supports mixing IP types within a network stack. For example, you can define IPv6 addresses for the IPsec layer and IPv4 addresses for the IP and Emulated Router layers. The IP and Emulated Router layers must, however, be of the same type. For more information, refer to [Support for Mixed IP Types](#).

The default is IPv4.

Default value = "IPv4"

`numEHCount`

The total number of hosts to be created for each of the emulated subnets.

This parameter is configurable only for site-to-site tests. In a remote-access test, an emulated client is operating as its own Secure Gateway; therefore, the IPsec plug-in sets the count to 1.

The default is 1, the minimum is 1 and the maximum is 65,534.

Default value = "1"

`emulatedSubnet`

The base address for enumerating all the emulated subnets in the range.

Default value = "40.0.0.0"

`protectedSubnet`

The base address for enumerating all the protected subnets in the range.

Default value = "70.0.0.0"

`emulatedSubnetSuffix`

Mask width for `emulatedSubnet`.

Default value = "24"

`protectedSubnetSuffix`

Mask width for `protectedSubnet`.

Default value = "24"

`esnIncrementBy`

The increment to be used for enumerating all the emulated subnets in the range.

The default IPv4 value is 0.0.1.0, and the default IPv6 value is ::100.

For each address in the IP range, a subnet will be generated by incrementing the emulated subnet field with the increment value. For example, if you have an IP range with a count of 5, the following subnets will be created on the port:

40.0.0.0/24

40.0.1.0/24

40.0.2.0/24

40.0.3.0/24

40.0.4.0/24

The number of hosts created on each subnet is defined in the *Host Count* field.

**Note:** The *ESN Increment by* value must be the same on the initiator side and the responder side. If there is a mismatch (0.0.1.1 versus 0.0.1.0, for example), the tunnels will come up but the traffic will fail.

Default value = "0.0.1.0"

`psnIncrementBy`

The increment to be used for enumerating all the protected subnets in the range. The generated subnets will be used as traffic selectors.

The default IPv4 value is 0.0.1.0, and the default IPv6 value is ::100.

**Note:** The *PSN Increment By* value must be the same on the initiator side and the responder side. If there is a mismatch (0.0.1.1 versus 0.0.1.0, for example), the tunnels will come up but the traffic will fail.

Default value = "0.0.1.0"

`peerPublicIPType`

The IP version to be used for describing the range:

- IPv4
- IPv6

The default is IPv4.

Default value = "IPv4"

`peerPublicIP`

The host name or public IP address of the peer.

You can specify a host name only for Port-to-DUT tests and only when the *Encapsulation Mode* is set to Tunnel Mode. Host names are resolved at run time.

Default value = "1.1.1.1"

`singlePH`

Select if this is a single protected subnet on the responder side. Selecting this field inhibits the generation of PSNs.

Note that this option is valid only for Port-to-DUT tests.

Default value = "False"

modeCfg

Specifies the Mode Configuration mode. This parameter is valid only when the *Test Scenario* parameter is set to Remote Access.

The choices are:

- Push: The Responder allocates an IP address for the Initiator to use as a traffic endpoint. In this case, the Responder pushes the allocated address to the Initiator. This mode uses the CFG\_SET / CFG\_ACK transaction sequence.

Note that Push cannot be configured with IKEv2.

- Pull: The Responder allocates an IP address for the Initiator to use as a traffic endpoint. In this case, the Initiator requests (pulls) the allocated address from the Responder. This mode uses the CFG\_REQUEST / CFG\_REPLY transaction sequence.

None: ModeCfg is not enabled. In this case, the traffic endpoint uses the underlying IP range address; this is the same IP address that is used for IKE control plane negotiations.

API values = "none", "push", "pull".

Default value = "none"

modeCfgFirstAddress

Defines the base address to be used for the ModeCfg address pool (the IP addresses that the server port will assign to the clients).

The three ModeCfg "Address" parameters are used only by responder ports. That is, they are used only for a Responder Mode test or for the responder port in a port-to-port test.

modeCfgAddressIncrement

Defines the increment value for the ModeCfg address pool.

The default value is 0.0.0.1.

modeCfgAddressSuffix

Defines the IP address suffix for the ModeCfg address pool.

The default value is 24, the minimum value is 1, and the maximum value is 128.

## EXAMPLE

```
$IPsec_R3 config \  
-psnIncrementBy          "0.0.1.0" \  

```

```
-singlePH                false \  
-numEHCount              1 \  
-psk                     "ipsec" \  
-enableNatt              false \  
-enabled                  true \  
-peerPublicIP            "1.1.1.1" \  
-dpdTimeout              10 \  
-ipsecIDTypeInitiator    "ip-addr-id" \  
-publishStats            false \  
-ikeMode                  "main" \  
-encAlgoPhase2           "3des" \  
-encAlgoPhase1           "3des" \  
-userGroups              false \  
-modeCfgAddressIncrement "0.0.0.1" \  
-xauth                   false \  
-modeCfgAddressSuffix    24 \  
-emulatedSubnetIpType    "IPv4" \  
-modeCfgFirstAddress     "30.0.0.1" \  
-ipsecIDTypeResponder    "ip-addr-id" \  
-modeCfg                  "none" \  
-ipCompression           false \  
-hashAlgoPhase1         "md5" \  
-protectedSubnet        "70.0.0.0" \  
-peerPublicIPType       "IPv4" \  
-groupName               "vpngroup" \  
-hashAlgoPhase2         "md5" \  
-pfsGroup                 "dh2" \  
-eapMethod                "md5" \  
-encapMode                "tunnel" \  
-ahNespMode               "ESPOnly" \  

```



---

```
-username          "ipsec-username" \  
-ikeVersion        "ikev2" \  
-enablePFS         false \  
-initialContact    false \  
-emulatedSubnet    "40.0.0.0" \  
-authMethod        "eap" \  
-testScenario      "site2site" \  
-esnIncrementBy    "0.0.1.0" \  
-lifeTimePhase1    3600 \  
-lifeTimePhase2    28800 \  
-protectedSubnetSuffix 24 \  
-prfAlgo           "md5" \  
-password          "ipsec-pass" \  
-fqdnSeedInitiator "" \  
-enableDPD         false \  
-emulatedSubnetSuffix 24 \  
-enableMultipleP2perP1 false \  
-dhGroup           "dh2" \  
-dpdIdlePeriod     1000 \  
-fqdnSeedResponder "" \  
-txPreFrag         false \  
-manualKeyingOpts  $my_ixNetIPSecManualKeyingOpts
```

## SEE ALSO

## Authentication

## SYNOPSIS

## DESCRIPTION

Creates an IPsec address range for addition to an `IPSecRangeList` object.

## SUBCOMMANDS

### OPTIONS

`name`

Name of the instance of the plugin.

Default value = "None"

`enabled`

If `True`, the range base is enabled.

Default value="True".

### Basic Parameters

`username`

The User Name field configures EAP in IKEv2, and Xauth in IKEv1. A username may be any unique identifier of the user, such as a login name, an email address, or an X.500 Distinguished Name. These usernames are sent to the DUT for authentication.

During the EAP exchange, the Responder may request the EAP identity of the Initiator; in this case, the configured User Name is sent. If the string is empty, the Initiator ID is sent.

This is a string value, with a maximum of 1024 characters.

Note that user names must be unique. The default value is *ipsec*.

Default = "ipsec"

`password`

The Password field is used for EAP-MD5 in IKEv2 and Xauth in IKEv1. The password, if specified, is sent to the DUT for authentication. This parameter takes a string value, with a maximum of 1024 characters.

Note that when this field is used for EAP-MD5, a null password is not permitted.

Passwords do not have to be unique; you can use the same password for all user names. The default value is *ipsec*.

Default = "ipsec"

`authMethod`

Specifies the authentication method for IKE phase 1. The choices are:

- Pre-Shared Key: If you select this method, enter the desired value in the *Pre-Shared Key* column.
- Certificates: If you select this method, use the Certificates tab in the Network Plug-in Settings window to configure the certificate parameters. This authentication method requires the CA root certificate, plus a client certificate for each tunnel.
- EAP: If you select this method (which is supported only with IKEv2):

1. Specify the EAP username in the *User Name* column.
2. Use the EAP-SIM tab or EAP-AKA tab in the Network Plug-in Settings window to configure the EAP parameters.
3. Make sure that the CA root certificate is available: it is required for EAP authentication.
4. If the *EAP Method* is TLS, also ensure that you have a client certificate for each tunnel.

The default is Pre-Shared Key.

Default value = "psk"

psk

The Pre-Shared Key value. This is a string value, with a maximum of 4096 characters.

The default is *ipsec*.

**Note:** Make certain that the Pre-Shared Key value does not include a trailing space. IxLoad will treat the trailing space as part of the value. Some DUTs will drop an Authentication Failed notification payload, while others will issue a Payload\_Malformed notification payload. In any case, the tunnel will be dropped by the DUT.

Default value = "ipsec"

userGroups

A Boolean value that enables or disables User Groups for extended authentication.

The default setting is unchecked.

Default value = "False"

groupName

A comma-separated list of user groups configured on the DUT. To specify more than one user group, separate the group names with commas. For example: *groupA, groupB, groupC*, and so on.

The default value is *vpngroup*.

Default value = "vpngroup"

**EXAMPLE**

```
$IPsec_R3 config \  
-psnIncrementBy          "0.0.1.0" \  
-singlePH                false \  
-numEHCount              1 \  
-psk                     "ipsec" \  
-enableNatt              false \  
-enabled                 true \  
-peerPublicIP            "1.1.1.1" \  
-dpdTimeout              10 \  
-ipsecIDTypeInitiator    "ip-addr-id" \  
-publishStats            false \  
-ikeMode                 "main" \  
-encAlgoPhase2           "3des" \  
-encAlgoPhase1           "3des" \  
-userGroups              false \  
-modeCfgAddressIncrement "0.0.0.1" \  
-xauth                   false \  
-modeCfgAddressSuffix    24 \  
-emulatedSubnetIpType    "IPv4" \  
-modeCfgFirstAddress     "30.0.0.1" \  
-ipsecIDTypeResponder    "ip-addr-id" \  
-modeCfg                 "none" \  
-ipCompression           false \  
-hashAlgoPhase1         "md5" \  
-protectedSubnet        "70.0.0.0" \  
-peerPublicIPType       "IPv4" \  
-groupName               "vpngroup" \  

```

---

```
-hashAlgoPhase2      "md5" \  
-pfsGroup            "dh2" \  
-eapMethod           "md5" \  
-encapMode           "tunnel" \  
-ahNespMode          "ESPOnly" \  
-username            "ipsec-username" \  
-ikeVersion          "ikev2" \  
-enablePFS           false \  
-initialContact      false \  
-emulatedSubnet      "40.0.0.0" \  
-authMethod          "eap" \  
-testScenario        "site2site" \  
-esnIncrementBy      "0.0.1.0" \  
-lifeTimePhase1     3600 \  
-lifeTimePhase2     28800 \  
-protectedSubnetSuffix 24 \  
-prfAlgo             "md5" \  
-password            "ipsec-pass" \  
-fqdnSeedInitiator  "" \  
-enableDPD           false \  
-emulatedSubnetSuffix 24 \  
-enableMultipleP2perP1 false \  
-dhGroup             "dh2" \  
-dpdIdlePeriod       1000 \  
-fqdnSeedResponder  "" \  
-txPreFrag           false \  
-manualKeyingOpts    $my_ixNetIPSecManualKeyingOpts
```

## SEE ALSO

## IKE Phase 1

### SYNOPSIS

### DESCRIPTION

Creates an IPSec address range for addition to an `IPSecRangeList` object.

### SUBCOMMANDS

### OPTIONS

`name`

Name of the instance of the plugin.

Default value = "None"

`enabled`

If `True`, the range base is enabled.

Default value="True".

`lifeTimePhase1`

Specifies the Phase 1 Security Association (SA) lifetime, in seconds.

The valid range of values is 0 through 31,557,600.

Default value = "3600"

`ikeMode`

Specifies the IKE (Internet Key Exchange) mode of communications for phase 1. The choices are:

- Main Mode - 6 messages exchanged with identity protection.
- Aggressive Mode - 3 messages exchanged without identity protection.

The default is Main Mode.

Default value = "main"

`hashAlgoPhase1`

---

Specifies the hashing algorithm to use for Phase 1. The choices are:

- HMAC-MD5: Message-Digest Algorithm 5.
- HMAC-SHA1: Secure Hash Algorithm 1.
- AES-XCBC: AUTH\_AES\_XCBC\_96 algorithm, defined in RFC3566. Supported by IKEv2 only.

The default is HMAC-MD5.

API values = "md5", "sha1", "aes-xcbc".

Default value = "md5"

dhGroup

Specifies the DH Group. The public-private cryptography used to create the shared secret uses an algorithm called Diffie-Hellman. DH Groups use different bit length selections in this calculation. The choices are:

- DH-1
- DH-2
- DH-5
- DH-14
- DH-15
- DH-16

The default is DH-2.

Default value = "dh2"

encAlgoPhase1

Specifies the encryption algorithm used to protect communications during phase 1 message exchange. The choices are:

- DES
- 3-DES
- AES-128
- AES-192
- AES-256

The default is 3-DES.

Default value = "3des"

prfAlgo

Specifies the algorithm used to perform Pseudo-Random Functions (key derivations). The choices are:

- HMAC-MD5: Message-Digest Algorithm 5.
- HMAC-SHA1: Secure Hash Algorithm 1.
- AES-XCBC: AUTH\_AES\_XCBC\_96 algorithm, defined in RFC3566.

This parameter is enabled for IKEv2 only.

The default value is HMAC-MD5.

Default value = "md5"

### EXAMPLE

```
$IPsec_R3 config \  
-psnIncrementBy          "0.0.1.0" \  
-singlePH                false \  
-numEHCount              1 \  
-psk                     "ipsec" \  
-enableNatt              false \  
-enabled                 true \  
-peerPublicIP            "1.1.1.1" \  
-dpdTimeout              10 \  
-ipsecIDTypeInitiator    "ip-addr-id" \  
-publishStats            false \  
-ikeMode                 "main" \  
-encAlgoPhase2           "3des" \  
-encAlgoPhase1           "3des" \  
-userGroups              false \  
-modeCfgAddressIncrement "0.0.0.1" \  
-xauth                   false \  
-modeCfgAddressSuffix    24 \  
-emulatedSubnetIpType    "IPv4" \  
-modeCfgFirstAddress     "30.0.0.1" \  
-ipsecIDTypeResponder    "ip-addr-id" \  
-modeCfg                 "none" \  
-ipCompression           false \  
-hashAlgoPhase1         "md5" \  

```



---

```
-protectedSubnet      "70.0.0.0" \  
-peerPublicIPType    "IPv4" \  
-groupName           "vpngroup" \  
-hashAlgoPhase2     "md5" \  
-pfsGroup            "dh2" \  
-eapMethod           "md5" \  
-encapMode           "tunnel" \  
-ahNespMode          "ESPOnly" \  
-username            "ipsec-username" \  
-ikeVersion          "ikev2" \  
-enablePFS           false \  
-initialContact      false \  
-emulatedSubnet     "40.0.0.0" \  
-authMethod          "eap" \  
-testScenario        "site2site" \  
-esnIncrementBy     "0.0.1.0" \  
-lifeTimePhase1     3600 \  
-lifeTimePhase2     28800 \  
-protectedSubnetSuffix 24 \  
-prfAlgo             "md5" \  
-password            "ipsec-pass" \  
-fqdnSeedInitiator  "" \  
-enableDPD           false \  
-emulatedSubnetSuffix 24 \  
-enableMultipleP2perP1 false \  
-dhGroup            "dh2" \  
-dpdIdlePeriod      1000 \  
-fqdnSeedResponder  "" \  
-txPreFrag          false \  
-manualKeyingOpts   $my_ixNetIPSecManualKeyingOpts
```

## SEE ALSO

## IKE Phase 2

## SYNOPSIS

## DESCRIPTION

Creates an IPsec address range for addition to an `IPSecRangeList` object.

## SUBCOMMANDS

## OPTIONS

`name`

Name of the instance of the plugin.

Default value = "None"

`enabled`

If `True`, the range base is enabled.

Default value="True".

`ipCompression`

When enabled, the IPsec plug-in provides support for the IP Payload Compression Protocol (IPComp). IPComp is negotiated during IKE phase 2 negotiations. When enabled, IxLoad compresses the IP packets prior to encryption, using the DEFLATE compression algorithm. The resulting reduction in size of the packets can significantly improve performance on a VPN device.

This setting is disabled by default.

API Default = "false"

`enablePFS`

If checked, enables PFS (perfect forward secrecy).

The default setting is unchecked.

Default value = "False"

---

lifeTimePhase2

Specifies the Phase 2 Security Association (SA) lifetime, in seconds.

The valid range is from 1 to 31557600.

Default value = "28800"

ahNespMode

Specifies the AH (Authentication Header) and ESP (Encapsulating Security Payload) options. The choices are:

- AH Only
- ESP Only
- Both AH and ESP

The default is ESP Only.

Default value = "ESPOnly"

encapMode

Specifies the IKE phase 2 encapsulation mode. The choices are:

- Tunnel Mode
- Transport Mode

Note that in IxLoad tests using transport mode, the data traffic terminates in the DUT: the data is not forwarded to the protected hosts on the Ixia port.

API values = "tunnel", "transport".

Default value = "tunnel"

hashAlgoPhase2

Specifies the hashing algorithm to use for Phase 2. The choices are:

- HMAC-MD5
- HMAC-SHA1

The default is HMAC-MD5.

Default value = "md5"

pfsGroup

Specifies the PFS Group. The choices are:

- DH-1
- DH-2
- DH-5
- DH-14

- DH-15
- DH-16

The default is DH-2.

Default value = "dh2"

encAlgoPhase2

Specifies the encryption algorithm used to protect communications during phase 1 and phase 2 message exchange. The choices are:

- Null
- DES
- 3-DES
- AES-128
- AES-192
- AES-256

The default is 3-DES.

Default value = "3des"

## EXAMPLE

```
$IPsec_R3 config \  
-psnIncrementBy          "0.0.1.0" \  
-singlePH                false \  
-numEHCount              1 \  
-psk                     "ipsec" \  
-enableNatt              false \  
-enabled                 true \  
-peerPublicIP            "1.1.1.1" \  
-dpdTimeout              10 \  
-ipsecIDTypeInitiator    "ip-addr-id" \  
-publishStats            false \  
-ikeMode                 "main" \  
-encAlgoPhase2           "3des" \  
-encAlgoPhase1           "3des" \  

```

---

```
-userGroups          false \  
-modeCfgAddressIncrement  "0.0.0.1" \  
-xauth              false \  
-modeCfgAddressSuffix  24 \  
-emulatedSubnetIpType  "IPv4" \  
-modeCfgFirstAddress   "30.0.0.1" \  
-ipsecIDTypeResponder  "ip-addr-id" \  
-modeCfg              "none" \  
-ipCompression         false \  
-hashAlgoPhase1        "md5" \  
-protectedSubnet       "70.0.0.0" \  
-peerPublicIPType      "IPv4" \  
-groupName            "vpngroup" \  
-hashAlgoPhase2        "md5" \  
-pfsGroup              "dh2" \  
-eapMethod              "md5" \  
-encapMode              "tunnel" \  
-ahNespMode            "ESPOnly" \  
-username              "ipsec-username" \  
-ikeVersion             "ikev2" \  
-enablePFS              false \  
-initialContact         false \  
-emulatedSubnet         "40.0.0.0" \  
-authMethod             "eap" \  
-testScenario           "site2site" \  
-esnIncrementBy         "0.0.1.0" \  
-lifeTimePhase1         3600 \  
-lifeTimePhase2         28800 \  
-protectedSubnetSuffix  24 \  
-prfAlgo                "md5" \  

```

```
-password                "ipsec-pass" \  
-fqdnSeedInitiator      "" \  
-enableDPD              false \  
-emulatedSubnetSuffix   24 \  
-enableMultipleP2perP1  false \  
-dhGroup                "dh2" \  
-dpdIdlePeriod          1000 \  
-fqdnSeedResponder      "" \  
-txPreFrag              false \  
-manualKeyingOpts       $my_ixNetIPSecManualKeyingOpts
```

## SEE ALSO

## Identification

## SYNOPSIS

## DESCRIPTION

Creates an IPsec address range for addition to an `IPSecRangeList` object.

## SUBCOMMANDS

## OPTIONS

name

Name of the instance of the plugin.

Default value = "None"

enabled

If `True`, the range base is enabled.

Default value="True".

`ipsecIDTypeInitiator`

Selects how IxLoad offers the local Emulated Gateway ID type for tunnel negotiations. The setting of this parameter determines the contents of the Identification Type and Identification Data fields in the IPsec packet sent to the DUT. (The Identification Type field describes the type of information contained in the Identification Data field. See RFC 2407 for more information.)

The choices are:

- `ID_IP_ADDR`: IxLoad sets the Identification Type field to 1 and inserts the Emulated Gateway address into the Identification Data field as a single four-octet IPv4 address.
- `ID_IP_ADDR_SUBNET`: IxLoad sets the Identification Type field to 4 and inserts the Emulated Gateway address into the Identification Data field as two four-octet values: an IPv4 address and an IPv4 network mask. (This option is not supported by IKEv2.)
- `ID_FQDN`: IxLoad sets the Identification Type field to 2 and inserts the Emulated Gateway address into the Identification Data field as a fully-qualified domain name string. For example, "foo.bar.com".
- `ID_USER_FQDN`: IxLoad sets the Identification Type field to 3 and inserts the Emulated Gateway address into the Identification Data field as a fully-qualified username string. For example, "piper@foo.bar.com".
- `ID_DER_ASN1_DN`: IxLoad sets the Identification Type field to 9 and inserts the Emulated Gateway address into the Identification Data field as a binary DER encoding of an ASN.1 X.500 Certificate Distinguished Name.
- `ID_KEY_ID`: IxLoad sets the Identification Type field to 11 and inserts the Emulated Gateway address into the Identification Data field as an opaque byte stream that may be used to pass vendor-specific information necessary to identify which pre-shared key should be used to authenticate Aggressive mode negotiations. `ID_KEY_ID` is recommended for Network Access Identifiers (NAIs) that do not include the realm component (reference: draft-eronen-ipsec-ikev2-clarifications). `ID_KEY_ID` is supported by IKEv2 only.

The default is `ID_IP_ADDR`.

API values = "ip-addr-id", ip-subnet-id", "fqdn-id", "fqdn-user", "der-asn1-dn", "key-id".

Default value = "ip-addr-id"

`fqdnSeedInitiator`

If you set the *Local ID Type* parameter to `ID_FQDN` or `ID_USER_FQDN`, enter the user name that IxLoad inserts into the IPsec packets to identify the emulated gateway.

This is a string value, with a maximum of 1024 characters.

For `FQDN_USER`, if you enter `user$@foo.bar.com`, IxLoad creates the user names `user-1@foo.bar.com`, `user2@foo.bar.com`, `user3@foo.bar.com`, and so on.

Default value = ""

`ipsecIDTypeResponder`

Selects how IxLoad offers the Protected Hosts (peer) ID type for tunnel negotiations. The setting of this parameter determines the contents of the Identification Type and Identification Data fields in the IPsec packet sent to the DUT. (The Identification Type field describes the type of information contained in the Identification Data field. See RFC 2407 for more information.)

The choices are:

- `ID_IP_ADDR`: IxLoad sets the Identification Type field to 1 and inserts the Emulated Gateway address into the Identification Data field as a single four-octet IPv4 address.
- `ID_IP_ADDR_SUBNET`: IxLoad sets the Identification Type field to 4 and inserts the Emulated Gateway address into the Identification Data field as two four-octet values: an IPv4 address and an IPv4 network mask. (This option is not supported by IKEv2.)
- `ID_FQDN`: IxLoad sets the Identification Type field to 2 and inserts the Emulated Gateway address into the Identification Data field as a fully-qualified domain name string. For example, "foo.bar.com".
- `ID_USER_FQDN`: IxLoad sets the Identification Type field to 3 and inserts the Emulated Gateway address into the Identification Data field as a fully-qualified username string. For example, "piper@foo.bar.com".
- `ID_DER_ASN1_DN`: IxLoad sets the Identification Type field to 9 and inserts the Emulated Gateway address into the Identification Data field as a binary DER encoding of an ASN.1 X.509 Certificate Distinguished Name.

`ID_KEY_ID`: IxLoad sets the Identification Type field to 11 and inserts the Emulated Gateway address into the Identification Data field as an opaque byte stream that may be used to pass vendor-specific information necessary to identify which pre-shared key should be used to authenticate Aggressive mode negotiations. `ID_KEY_ID` is recommended for Network Access Identifiers (NAIs) that do not include the realm component (reference: draft-eronen-ipsec-ikev2-clarifications). `ID_KEY_ID` is supported by IKEv2 only.

API values = "ip-addr-id", "ip-subnet-id", "fqdn-id", "fqdn-user", "der-asn1-dn", "key-id".

Default value = "ip-addr-id"

`fqdnSeedResponder`

If you set the *Peer ID Type* parameter to `ID_FQDN` or `ID_USER_FQDN`, enter the user name that IxLoad inserts into the IPsec packets to identify the protected hosts.

This is a string value, with a maximum of 1024 characters.

For `FQDN_USER`, if you enter `user$@foo.bar.com`, IxLoad creates the user names `user-1@foo.bar.com`, `user2@foo.bar.com`, `user3@foo.bar.com`, and so on.

Default value = ""

## EXAMPLE

```
$IPsec_R3 config \  
-psnIncrementBy          "0.0.1.0" \  

```



---

```
-singlePH           false \  
-numEHCount        1 \  
-psk                "ipsec" \  
-enableNatt        false \  
-enabled           true \  
-peerPublicIP      "1.1.1.1" \  
-dpdTimeout        10 \  
-ipsecIDTypeInitiator "ip-addr-id" \  
-publishStats      false \  
-ikeMode           "main" \  
-encAlgoPhase2     "3des" \  
-encAlgoPhase1     "3des" \  
-userGroups        false \  
-modeCfgAddressIncrement "0.0.0.1" \  
-xauth             false \  
-modeCfgAddressSuffix 24 \  
-emulatedSubnetIpType "IPv4" \  
-modeCfgFirstAddress  "30.0.0.1" \  
-ipsecIDTypeResponder "ip-addr-id" \  
-modeCfg           "none" \  
-ipCompression     false \  
-hashAlgoPhase1    "md5" \  
-protectedSubnet   "70.0.0.0" \  
-peerPublicIPType  "IPv4" \  
-groupName         "vpngroup" \  
-hashAlgoPhase2    "md5" \  
-pfsGroup          "dh2" \  
-eapMethod         "md5" \  
-encapMode         "tunnel" \  
-ahNespMode        "ESPOnly" \  

```

```
-username                "ipsec-username" \  
-ikeVersion              "ikev2" \  
-enablePFS               false \  
-initialContact          false \  
-emulatedSubnet          "40.0.0.0" \  
-authMethod              "eap" \  
-testScenario            "site2site" \  
-esnIncrementBy          "0.0.1.0" \  
-lifeTimePhase1          3600 \  
-lifeTimePhase2          28800 \  
-protectedSubnetSuffix   24 \  
-prfAlgo                 "md5" \  
-password                "ipsec-pass" \  
-fqdnSeedInitiator       "" \  
-enableDPD               false \  
-emulatedSubnetSuffix    24 \  
-enableMultipleP2perP1   false \  
-dhGroup                  "dh2" \  
-dpdIdlePeriod           1000 \  
-fqdnSeedResponder       "" \  
-txPreFrag                false \  
-manualKeyingOpts        $my_ixNetIPSecManualKeyingOpts
```

## SEE ALSO

## IKE Control

## SYNOPSIS

## DESCRIPTION

Creates an IPsec address range for addition to an `IPSecRangeList` object.

## SUBCOMMANDS

## OPTIONS

`name`

Name of the instance of the plugin.

Default value = "None"

`enabled`

If `True`, the range base is enabled.

Default value="True".

`dpdTimeout`

Hash key used for ESP-mode traffic originating from the Left Subnet and destined for the Right Subnet. The forward hash key is a variable length value; the key length is determined by the Phase 2 encryption algorithm that you have configured. You can enter the value as a string or as a hexadecimal number (use a leading `0x` for hexadecimal). If you enter the value as a string, `IxLoad` automatically converts it to an ASCII value.

The default value is 10.

`enableNatt`

Enable this parameter when running IPsec over NAT devices. When enabled, the IPsec plug-in implements NAT-T for all the traffic in the range.

NAT-T is configurable in IPv4 environments only. The default value is false.

API values = "md5", "sha1", "aes-xcbc".

Default value = "md5"

`dpdIdlePeriod`

The interval for sending DPD messages, in seconds. For example, if you set this to 60, the IPsec plug-in sends DPD HELLO messages every 60 seconds to each peer defined for the range. This value must be smaller than the tunnel lifetimes.

The default value is 1000.

`initialContact`

When enabled, the IPsec plug-in will send the INITIAL\_CONTACT notification payload as part of IKE SA establishment.

This parameter is disabled by default.

(Note that the IPsec plug-in always ignores the INITIAL\_CONTACT notification payload, if it is received.)

API Default = false

`enableDPD`

When enabled, each IKE peer in the range uses the Dead Peer Detection (DPD) protocol to determine proof of liveness of the other peer. The peers send DPD HELLO messages according to the interval that you specify (the *DPD Idle Period*).

When disabled, the IKE peers do not send DPD HELLO messages.

An IPsec endpoint uses DPD to confirm that its peer is still up. DPD is implemented in IKE through the use of an asynchronous, bidirectional message exchange:

- DPD HELLO
- DPD HELLO ACK

A complete DPD exchange (transmission of DPD HELLO and receipt of the corresponding DPD HELLO ACK) serves as proof of liveness. If a VPN device does not receive a response to a DPD HELLO within a specified time, it assumes that the peer is dead or unreachable, and tears down the tunnel.

### Notes:

- If DPD is enabled, IxLoad always sends the DPD messages regardless of the traffic that is being sent over the tunnel.
- The IPsec plug-in always responds to DPD messages received from the DUT whether or not DPD is enabled.

The IPsec plug-in implementation of DPD does not use an explicit retry mechanism. For example, if you set the idle period to 5 seconds and the timeout to 14 seconds, the plug-in will send two DPD HELLOs (at 5 and 10 seconds) within the timeout period. If at least one of those hellos receives a DPD HELLO ACK, the timer will be reset and the tunnel will remain up.

Default value = "false".

`txPreFrag`

When enabled, the IPsec plug-in will—if necessary—pre-fragment IPsec-encapsulated payloads into multiple smaller UDP packets prior to encrypting the payload. This is a transmit-only option; it is not negotiated, and the two ends need not agree on it. The fragment size is determined by the *MTU* setting in the MAC/VLAN network stack element.

Pre-fragmentation is applicable to Tunnel Mode only. In Tunnel Mode there are two IP headers, thus two places where IP-level fragmentation can be done. The default behaviour is to fragment at the outer

IP header (post-fragmentation). With pre-fragmentation enabled, fragmentation is performed at the inner IP header.

When disabled, the IPsec plug-in performs post-fragmentation on the IP packets. In this case, the packet is first encapsulated and then fragmented at the outer IP header.

To configure pre-fragmentation:

1. Set the *MTU* value (in the MAC/VLAN stack element) to the desired packet size.
2. Enable the *Pre-fragmentation* parameter.

For example, if you set the *MTU* value to 600, and you have a UDP payload that is 2400 bytes long, the plug-in will fragment it into four IP datagrams prior to encrypting the payload.

API Default value = "false"

## EXAMPLE

```
$IPsec_R3 config \
-psnIncrementBy          "0.0.1.0" \
-singlePH                false \
-numEHCount              1 \
-psk                     "ipsec" \
-enableNatt              false \
-enabled                 true \
-peerPublicIP            "1.1.1.1" \
-dpdTimeout              10 \
-ipsecIDTypeInitiator    "ip-addr-id" \
-publishStats            false \
-ikeMode                 "main" \
-encAlgoPhase2           "3des" \
-encAlgoPhase1           "3des" \
-userGroups              false \
-modeCfgAddressIncrement "0.0.0.1" \
-xauth                   false \
-modeCfgAddressSuffix    24 \
```

```

-emulatedSubnetIpType      "IPv4" \
-modeCfgFirstAddress      "30.0.0.1" \
-ipsecIDTypeResponder     "ip-addr-id" \
-modeCfg                  "none" \
-ipCompression            false \
-hashAlgoPhase1          "md5" \
-protectedSubnet         "70.0.0.0" \
-peerPublicIPType        "IPv4" \
-groupName                "vpngroup" \
-hashAlgoPhase2          "md5" \
-pfsGroup                 "dh2" \
-eapMethod                "md5" \
-encapMode                "tunnel" \
-ahNespMode               "ESPOnly" \
-username                 "ipsec-username" \
-ikeVersion               "ikev2" \
-enablePFS                false \
-initialContact           false \
-emulatedSubnet           "40.0.0.0" \
-authMethod               "eap" \
-testScenario             "site2site" \
-esnIncrementBy          "0.0.1.0" \
-lifeTimePhase1          3600 \
-lifeTimePhase2          28800 \
-protectedSubnetSuffix   24 \
-prfAlgo                  "md5" \
-password                 "ipsec-pass" \
-fqdnSeedInitiator       "" \
-enableDPD                false \
-emulatedSubnetSuffix    24 \

```

```
-enableMultipleP2perP1      false \  
-dhGroup                    "dh2" \  
-dpdIdlePeriod              1000 \  
-fqdnSeedResponder         "" \  
-txPreFrag                  false \  
-manualKeyingOpts          $my_ixNetIPSecManualKeyingOpts
```

## SEE ALSO

## Keys

## SYNOPSIS

## DESCRIPTION

If manual keying is enabled, this object defines the keying options.

## SUBCOMMANDS

## OPTIONS

`forwardEncryptKey`

Encryption key used for traffic originating from the Left Subnet and destined for the Right Subnet. The forward encryption key is a variable length value; the key length is determined by the Phase 2 encryption algorithm that you have configured. You can enter the value as a string or as a hexadecimal number (use a leading `0x` for hexadecimal). If you enter the value as a string, IxLoad automatically converts it to an ASCII value.

API default value="" (null)

`forwardEncryptKeyIncrement`

The increment value for the Forward Encryption Key. You can enter the value as a string or as a hexadecimal number (use a leading `0x` for hexadecimal). If you enter the value as a string, IxLoad automatically converts it to an ASCII value.

The default value is `0x00`.

API default value="0x00"

`forwardHashKeyAH`

Hash key used for AH-mode traffic originating from the Left Subnet and destined for the Right Subnet. The forward hash key is a variable length value; the key length is determined by the Phase 2 encryption algorithm that you have configured. You can enter the value as a string or as a hexadecimal number (use a leading 0x for hexadecimal). If you enter the value as a string, IxLoad automatically converts it to an ASCII value.

API default value="" (null)

`forwardHashKeyAHincrement`

The increment value for the Forward Hash Key/AH, for each tunnel. You can enter the value as a string or as a hexadecimal number (use a leading 0x for hexadecimal). If you enter the value as a string, IxLoad automatically converts it to an ASCII value.

The default value is 0x00.

API default value="0x00" (null)

`forwardHashKeyESP`

Hash key used for ESP-mode traffic originating from the Left Subnet and destined for the Right Subnet. The forward hash key is a variable length value; the key length is determined by the Phase 2 encryption algorithm that you have configured. You can enter the value as a string or as a hexadecimal number (use a leading 0x for hexadecimal). If you enter the value as a string, IxLoad automatically converts it to an ASCII value.

API default value="" (null)

`forwardHashKeyESPincrement`

The increment value for the Forward Hash Key/ESP, for each tunnel. You can enter the value as a string or as a hexadecimal number (use a leading 0x for hexadecimal). If you enter the value as a string, IxLoad automatically converts it to an ASCII value.

The default value is 0x00.

API default value="0x00"

`forwardSPI`

The Security Parameter Index for IPsec traffic originating from the Left Subnet and destined for the Right Subnet. The SPI is a 32-bit value.

You can enter the Forward SPI using either decimal or hexadecimal notation (enter hexadecimal values with a leading 0x). If you enter the value in decimal, IxLoad automatically converts your entry to a hexadecimal number.

API default value="0" (null)

`forwardSPIincrement`



The incrementor for the Forward SPI.

You can enter the increment value in either decimal or hexadecimal notation (enter hexadecimal values with a leading 0x). If you enter it in decimal, IxLoad automatically converts your entry to a hexadecimal number.

API default value="0" (null)

```
reverseEncryptKey
```

Encryption key used for traffic originating from the Right Subnet and destined for the Left Subnet. The reverse encryption key is a variable length value; the key length is determined by the Phase 2 encryption algorithm that you have configured. You can enter the value as a string or as a hexadecimal number (use a leading 0x for hexadecimal). If you enter the value as a string, IxLoad automatically converts it to an ASCII value.

API default value="" (null)

```
reverseEncryptKeyIncrement
```

Value for incrementing the Reverse Encryption Key, for each tunnel. You can enter the value as a string or as a hexadecimal number (use a leading 0x for hexadecimal). If you enter the value as a string, IxLoad automatically converts it to an ASCII value.

The default value is 0x00.

API default value=""0x00"" (null)

```
reverseHashKeyAH
```

Hash key used for AH-mode traffic originating from the Right Subnet and destined for the Left Subnet. The reverse hash key is a variable length value; the key length is determined by the Phase 2 encryption algorithm that you have configured. You can enter the value as a string or as a hexadecimal number (use a leading 0x for hexadecimal). If you enter the value as a string, IxLoad automatically converts it to an ASCII value.

API default value="" (null)

```
reverseHashKeyAHincrement
```

Value for incrementing the Reverse Hash Key/AH, for each tunnel. You can enter the value as a string or as a hexadecimal number (use a leading 0x for hexadecimal). If you enter the value as a string, IxLoad automatically converts it to an ASCII value.

The default value is 0x00.

```
defaultValue=""0x00"" />
```

```
reverseHashKeyESP
```

Hash key used for ESP-mode traffic originating from the Right Subnet and destined for the Left Subnet. The reverse hash key is a variable length value; the key length is determined by the Phase 2 encryption algorithm that you have configured. You can enter the value as a string or as a hexadecimal

number (use a leading 0x for hexadecimal). If you enter the value as a string, IxLoad automatically converts it to an ASCII value.

API default value="" (null)

```
reverseHashKeyESPincrement
```

Value for incrementing the Reverse Hash Key/ESP, for each tunnel. You can enter the value as a string or as a hexadecimal number (use a leading 0x for hexadecimal). If you enter the value as a string, IxLoad automatically converts it to an ASCII value.

The default value is 0x00.

API default value="0x00"

```
reverseSPI
```

The Security Parameter Index for IPsec traffic originating from the Right Subnet and destined for the Left Subnet. The SPI is a 32-bit value.

You can enter the Reverse SPI using either decimal or hexadecimal notation (enter hexadecimal values with a leading 0x). If you enter the value in decimal, IxLoad automatically converts your entry to a hexadecimal number.

API default value="0"

```
reverseSPIincrement
```

The incrementor for the Reverse SPI.

You can enter the increment value in either decimal or hexadecimal notation (enter hexadecimal values with a leading 0x). If you enter it in decimal, IxLoad automatically converts your entry to a hexadecimal number.

API default value="0"

## EXAMPLE

```
set my_ixNetIPSecManualKeyingOpts [::IxLoad new ixNetIPSecManualKeyingOpts]
$my_ixNetIPSecManualKeyingOpts config \
-forwardHashKeyESPincrement      "0x00" \
-reverseEncryptKey              "abcdefabcdefabcdefabcdef" \
-reverseSPI                      0 \
-reverseHashKeyAH                "" \
-reverseHashKeyESP              "abcdefabcdef9876" \
-forwardEncryptKeyIncrement      "0x00" \
```

---

```
-forwardSPI                0 \  
-reverseHashKeyESPincrement    "0x00" \  
-forwardHashKeyAHincrement    "0x00" \  
-reverseSPIincrement          0 \  
-forwardHashKeyESP            "abcdefabcdef1223" \  
-reverseEncryptKeyIncrement    "0x00" \  
-forwardSPIincrement          0 \  
-forwardEncryptKey            "abcdefabcdefabcdef" \  
-forwardHashKeyAH             "" \  
-reverseHashKeyAHincrement     "0x00"
```

## SEE ALSO

## Tunnel Setup

### SYNOPSIS

### DESCRIPTION

Configures the IPSec tunnel setup options. Global settings apply to all network groups and all ranges defined for a test.

### SUBCOMMANDS

### OPTIONS

testType

The type of test that this IPSec encapsulation will support:

- Port to DUT

- Port to Port

If you are setting up a back-to-back test, select the Port to Port option.

Default value = "P2D"

`tunnelSetupTimeout`

The number of seconds to wait for a response from the DUT before declaring that a tunnel setup attempt has failed.

The default is 30, the minimum is 1, the maximum is 600.

Default value = "30"

`numRetries`

The number of attempts that the IPSec plug-in makes to renegotiate the Phase 1 and 2 SAs. If all attempts at renegotiation fail, the plug-in drops the tunnel.

The default is 0, the minimum is 0, the maximum is 100.

Default value = "0"

`retryInterval`

The number of seconds to wait before retrying the tunnel creation.

The default is 10, the minimum is 1, the maximum is 60.

Default value = "10"

`retryDelay`

Specifies the desired delay between subsequent attempts, specified in seconds.

The default is 10, the minimum is 1, the maximum is 60.

Default value = "10"

`sendCiscoVid`

If checked, IxLoad sends the **Cisco-Unity** Vendor ID payload type. Valid for IKEv1 only.

Default value = "False"

`useMaxInitiationRate`

If `true`, IxLoad attempts to create tunnels at its fastest possible rate.

If `false`, IxLoad attempts to create tunnels at the rate that you specify as the *Initiation Rate* parameter.

Default value = "False"

`useMaxPendingTunnels`

If `true`, `IxLoad` attempts to create the largest possible pool of pending tunnels, and continues to initiate tunnels irrespective of how many tunnels are waiting to be set up.

If `false`, `IxLoad` attempts to create a pool of pending tunnels no larger than the value that you specify as the *Maximum Number of Pending Tunnels* parameter.

Default value = "False"

`enableRekey`

Enables or disables renegotiation of Phase 1 and Phase 2 SAs on expiry of tunnel lifetimes:

- When disabled, tunnels are torn down when their lifetimes expire.
- When enabled, the tunnels' Phase 1 and Phase 2 options are renegotiated before their lifetimes expire, and the tunnels stay up.

The rekey parameters control the renegotiation process.

Default value = "False"

`rekeyRetries`

The total number of rekey retries permitted.

This defines the number of attempts that the IPsec plug-in makes to renegotiate the Phase 1 and 2 SAs. If all attempts at renegotiation fail, the IPsec plug-in drops the tunnel.

The valid range of values is from 0 through 10,000. The default value is 0.

Default value = "0"

`rekeyFuzzPercentage`

The maximum rekey fuzz percentage.

The fuzz percentage is used to randomize rekeying intervals. It is randomly applied to the Rekey Margin to either shrink (for values under 100) or enlarge (for values over 100) the window of time during which the IPsec plug-in performs rekeying for the tunnels. It prevents all the rekey attempts from occurring at the same time and overloading the DUT.

The valid range of values is from 0 through 100. The default value is 0.

Default value = "0"

`rekeyMargin`

The rekey margin, in seconds.

This is the number of seconds that are subtracted from the connection expiration time, to ensure that creation of new IPsec SAs begins before the current IPsec SAs expire.

The valid range of values is from 0 through 10,000. The default value is 0.

Default value = "0"

**EXAMPLE**

```
set my_ixNetIPSecTunnelSetup [::IxLoad new ixNetIPSecTunnelSetup]
$my_ixNetIPSecTunnelSetup config \
-retryInterval          10 \
-useMaxPendingTunnels      false \
-enableRekey            false \
-useMaxInitiationRate     false \
-sendCiscoVid            false \
-testType                "P2D" \
-rekeyRetries            0 \
-tunnelSetupTimeout       30 \
-retryDelay              10 \
-rekeyMargin             10 \
-rekeyFuzzPercentage      0 \
-numRetries              0
```

**SEE ALSO**

## Certificates

**SYNOPSIS****DESCRIPTION**

Configures the certificate parameters when the chosen authentication method is *Certificates*.

**SUBCOMMANDS****OPTIONS**

uniqueCert

If true, IxLoad uses the same certificate to negotiate every tunnel. This can significantly speed up the negotiation process, but it does not stress the DUT's ability to cache certificates or to negotiate tunnels using multiple certificates, as would happen in an actual VPN.

If you select a cache as the Certificate source and the cache contains more than one certificate, IxLoad selects the certificate file with the oldest timestamp.

Default value = "False"

`certSource`

If enabled, IxLoad gets the certificates from the Certificate Authority (CA). If you select this option, IxLoad deletes any cached certificates from the chassis (from the folder specified for 'Certificates Folder').

Default value = "kNewCert"

`certSubjectAltDN`

A comma-separated list of subject alternative names. The subject alternative name is an X.509 v3 extension that permits various literal values to be included in the configuration file.

defaultValue="" (null)

`caURL`

Certificate Authority URL. Check this option to use a certificate authority (CA) server for authentication. Enter the CA server's URL in the field. IxLoad uses Simple Certificate Enrollment Protocol (SCEP) to obtain signed certificates from the CA.

This option is not supported in a port-to-port test.

Default value = ""

`caDN`

Issuing CA Distinguished Name. Name of the Certificate Authority (CA) that issued the DUT's certificate.

This field includes the Distinguished Name fields and values that IxLoad sends to the DUT's CA. These can include the following fields:

- CN: Common name
- E: Email address
- OU: Organizational unit
- O: Organization name
- L: Locality
- S: State or province
- C: 2-letter country or region name

For example,

CN=Liesl Benjamin, E=liesl@ixia.com, OU=Security, O=Ixia, L=Los Angeles S=California, C=US

Default value = ""

`certSubjectDN`

Subject Distinguished Name. A name designating the owner of the certificate.

This field includes the Distinguished Name fields and values that IxLoad sends to the DUT's CA. These can include the same fields as described for the *Issuing CA Distinguished Name* parameter.

Default value = ""

`remoteIkeId`

Attribute that identifies the DUT in its certificate. You can enter the following in this field:

- A fully-qualified domain name (FQDN).

Syntax: @<domain>

For example, @ixiacom.com

- An email address.

Syntax: user@domain

For example, liesl@ixiacom.com

- An IP address.

Syntax: IP=<address>

For example, IP=192.168.0.1

- A context string.

Syntax: attribute=value

For example, CN=liesl benjamin, O=ixia, C=us

This is a string value, with a maximum length of 2048 characters.

Default value = ""

`bitSize`

Bit Size for the Keys. The choices are: 512, 1024, 2048.

Default value = "k512"

`saveCert`

If `true`, IxLoad stores certificates in the specified folder on the chassis.

The default folder is specified in `cacheCertFolder`.

Default value = "False"

`cacheCertFolder`



Folder where certificates are stored.

Default value = "C:\Program Files\Ixia\CachedCerts"

certParentFolder

Root path of certificate folder.

Default value = "C:\Program Files\Ixia\CachedCerts"

certNumber

Number of certificates cached.

If the number of tunnels exceeds the number of certificates, IxLoad reuses certificates as necessary.

Default value = ""

earlyExpDate

Earliest expiry date and time of cached certificates.

Default value = ""

lateExpDate

Latest expiry date and time of cached certificates.

Default value = ""

usePerRangeCertNameExp

If enabled, IxLoad expands the \$ (if present) in the *Subject Distinguished Name* field on a per-range basis.

If disabled (the default), IxLoad expands the \$ globally.

Default value = "False"

## EXAMPLE

```
set my_ixNetIPSecSessionData [$Test1 getSessionSpecificData "IPSecPlugin"]
```

```
set my_ixNetIPSecCertificates [::IxLoad new ixNetIPSecCertificates]
```

```
$my_ixNetIPSecCertificates config \
```

```
-uniqueCert                false \
```

```
-usePerRangeCertNameExp    false \
```

```
-caURL                      "" \
```

```
-bitSize                    "k512" \
```

```
-remoteIkeId                "" \
```

```
-lateExpDate          "" \  
-cacheCertFolder     "C:\\Program Files\\Ixia\\CachedCerts" \  
-saveCert            false \  
-certSubjectAltDN    "" \  
-certSubjectDN       "" \  
-certParentFolder    "C:\\Program Files\\Ixia\\CachedCerts" \  
-earlyExpDate        "" \  
-certSource          "kNewCert" \  
-caDN                "" \  
-certNumber          ""
```

## SEE ALSO

## EAP Common

### SYNOPSIS

### DESCRIPTION

Configures the common portion of the EAP SIM and AKA tuple. Configure the EAP SIM and AKA tuples as lists.

### SUBCOMMANDS

### OPTIONS

imsi

A string value that represents the International Mobile Subscriber Identity.

Default value="" (null)

rand

A hexadecimal number that represents the 128-bit random challenge generated by the DUT.

Default value="" (null)

## EXAMPLE

## SEE ALSO

## EAP AKA

### SYNOPSIS

### DESCRIPTION

Configures the AKA portion of an EAP AKA tuple

### SUBCOMMANDS

### OPTIONS

ck

A 128-bit hexadecimal value representing the Cipher Key. The CK is used for encryption.

(On EAP-AKA full authentication, keying material (a Master Key) is generated from the Integrity Key (IK), the Cipher Key (CK), and the peer identity.)

Default value="" (null)

ik

A 128-bit hexadecimal value representing the Integrity Key. The IK is a session key used for integrity checks.

(On EAP-AKA full authentication, keying material (a Master Key) is generated from the Integrity Key (IK), the Cipher Key (CK), and the peer identity.)

Default value="" (null)

res

A 128-bit hexadecimal value representing the authentication result that the identity module produces and sends to the home environment, following successful verification of the AUTN. The RES, together with the RAND, authenticates the peer to the server.

(The AUTN is the authenticator part of the authentication vector produced by the home environment. The home environment is the home operator's authentication network infrastructure.)

Default value="" (null)

### EXAMPLE

```
$my_ixNetIPSecSessionData eapAkaTuples.clear
```

```
set my_ixNetIPSecEapAkaTuple [::IxLoad new ixNetIPSecEapAkaTuple]
```

```
# ixNet objects needs to be added in the list before they are configured!
```

```
$my_ixNetIPSecSessionData eapAkaTuples.appendItem -object $my_ixNetIPSecEapAkaTuple
```

```
$my_ixNetIPSecEapAkaTuple config \
```

```
-ck "0xc0c0c0c0c0c0c0c0c0c0c0c0c0c0c0" \
```

```
-rand "0xe0e0e0e0e0e0e0e0e0e0e0e0e0e0e0" \
```

```
-ik "0xb0b0b0b0b0b0b0b0b0b0b0b0b0b0b0" \
```

```
-imsi "" \
```

```
-res "0xd0d0d0d0d0d0d0d0d0d0d0d0d0d0d0"
```

### SEE ALSO

## EAP SIM

### SYNOPSIS

## DESCRIPTION

Configures the SIM portion of an EAP AKA tuple

## SUBCOMMANDS

## OPTIONS

`kc`

A hexadecimal number that represents the 64-bit ciphering key used as a session key for encryption of the over-the-air channel.

The Kc key was originally intended to be used as an encryption key over the air interface, but in the EAP-SIM protocol, it is used for deriving keying material and is not directly used. (Note that the secrecy of Kc is critical to the security of this protocol.)

Default value = "" (null)

`sres`

A hexadecimal number that represents the 32-bit signed response generated by the SIM.

Default value = "" (null)

## EXAMPLE

```
$my_ixNetIPSecSessionData eapSimTuples.clear
```

```
set my_ixNetIPSecEapSimTuple [::IxLoad new ixNetIPSecEapSimTuple]
```

```
# ixNet objects needs to be added in the list before they are configured!
```

```
$my_ixNetIPSecSessionData eapSimTuples.appendItem -object $my_ixNetIPSecEapSimTuple
```

```
$my_ixNetIPSecEapSimTuple config \
```

```
-kc "0xa0a1a2a3a4a5a6a7" \
```

```
-rand "0x101112131415161718191a1b1c1d1e1f" \
```

```
-sres "0xd1d2d3d4" \
```

```
-imsi ""
```

**SEE ALSO**

**IPSec Example**

This section shows an example of how to create an IPSec plugin in the Tcl API.

```
#####
# IxLoad ScriptGen created TCL script
# Network1 serialized using version 4.10.0.79
# IPsec.tcl made on Aug 14 2008 15:25
#####

set Network1 [::IxLoad new ixNetworkGroup $chassisChain]
$Network1 config \
    -comment          "" \
    -name              Create a network group. "Network1" \
    -macMappingMode   0 \
    -linkLayerOptions 0

$Network1 globalPlugins.clear Clear the global plugins list.

Begin appending items to global plugin list.

set GratARP [::IxLoad new ixNetGratArpPlugin] Optionally, enable
# ixNet objects needs to be added in the list Gratuitous ARP.
# before they are configured!
$Network1 globalPlugins.appendItem -object $GratARP

$GratARP config \
    -enabled          true \
    -name              "GratARP"
```

```

set TCP [::IxLoad new ixNetTCPPlugin]
# ixNet objects needs to be added in the list
# before they are configured!
$Network1 globalPlugins.appendItem -object $TCP

$TCP config \
    -tcp_bic 0 \
    -tcp_tw_recycle true \
    -tcp_retries2 5 \
    -tcp_retries1 3 \
    -tcp_keepalive_time 75 \
    -tcp_moderate_rcvbuf 0 \
    -tcp_rfc1337 false \
    -tcp_ipfrag_time 30 \
    -tcp_rto_max 60000 \
    -tcp_vegas_alpha 2 \
    -tcp_ecn false \
    -tcp_westwood 0 \
    -tcp_rto_min 1000 \
    -tcp_reordering 3 \
    -tcp_vegas_cong_avoid 0 \
    -tcp_keepalive_intvl 7200 \
    -tcp_rmem_max 262144 \
    -tcp_orphan_retries 0 \
    -tcp_max_tw_buckets 180000 \
    -tcp_wmem_default 4096 \
    -tcp_low_latency 0 \
    -tcp_rmem_min 4096 \
    -tcp_adv_win_scale 2 \
    -tcp_wmem_min 4096 \
    -tcp_port_min 1024 \
    -tcp_stdurg false \
    -tcp_port_max 65535 \
    -tcp_fin_timeout 60 \
    -tcp_no_metrics_save false \
    -tcp_dsack true \
    -tcp_mem_high 49152 \
    -tcp_frto 0 \
    -tcp_app_win 31 \
    -ip_no_pmtu_disc false \
    -tcp_window_scaling false \
    -name "TCP" \

```

Configure the TCP  
portion of the stack.

```
set Settings [::IxLoad new ixNetIxLoadSettingsPlugin]
# ixNet objects needs to be added in the list
# before they are configured!
$Network1 globalPlugins.appendItem -object $Settings

$Settings config \
    -teardownInterfaceWithUser      false \
    -name                            "Settings" \
    -interfaceBehavior               0

set Ethernet_1 [$Network1 getLLPlugin]

set my_ixNetEthernetELMPlugin [::IxLoad new ixNetEthernetELMPlugin]
$my_ixNetEthernetELMPlugin config \
    -negotiationType                 "master" \
    -negotiateMasterSlave            true

$Ethernet_1 config \
    -advertise10Full                 true \
    -name                             "Ethernet-1" \
    -autoNegotiate                   true \
    -advertise100Half                true \
    -advertise10Half                 true \
    -speed                           "k100FD" \
    -advertise1000Full               true \
    -advertise100Full                true \
    -cardElm

$my_ixNetEthernetELMPlugin

$Ethernet_1 childrenList.clear
```

Configure the Dynamic  
Control plane settings.

Configure the physical  
layer properties.



```

set MAC_VLAN_8 [::IxLoad new ixNetL2EthernetPlugin]
# ixNet objects needs to be added in the list before they are configured!
$Ethernet_1 childrenList.appendItem -object $MAC_VLAN_8

$MAC_VLAN_8 config \
    -name "MAC/VLAN-8"

$MAC_VLAN_8 childrenList.clear

set Emulated_Router_1 [::IxLoad new ixNetEmulatedRouterPlugin]
# ixNet objects needs to be added in the list before they are configured!
$MAC_VLAN_8 childrenList.appendItem -object $Emulated_Router_1

$Emulated_Router_1 config \
    -name "Emulated Router-1"

$Emulated_Router_1 childrenList.clear

set IP_3 [::IxLoad new ixNetIPv4V6Plugin]
# ixNet objects needs to be added in the list before they are configured!
$Emulated_Router_1 childrenList.appendItem -object $IP_3

$IP_3 config \
    -name "IP-3"

$IP_3 childrenList.clear

set IPSec_1 [::IxLoad new ixNetIPSecPlugin]
# ixNet objects needs to be added in the list before they are configured!
$IP_3 childrenList.appendItem -object $IPSec_1

$IPSec_1 config \
    -name "IPSec-1"

$IPSec_1 childrenList.clear
$IPSec_1 extensionList.clear
$IP_3 extensionList.clear
$Emulated_Router_1 extensionList.clear
$MAC_VLAN_8 extensionList.clear
$Ethernet_1 extensionList.clear

```

Configure the MAC addresses and VLAN tags.

Configure an Emulated Router.

Configure an address range for the Emulated Router.

Add an IPSec plugin.

Clear the lists of extension protocols.

```
#####
# Setting the ranges starting with the plugin on top of the stack
#####
$IPSec_1 rangeList.clear

set IPSec_R1 [::IxLoad new ixNetIPSecRange]
# ixNet objects needs to be added in the list
# before they are configured!
$IPSec_1 rangeList.appendItem -object $IPSec_R1

$IPSec_R1 config \
    -psnIncrementBy "0.0.1.0" \
    -singlePH false \
    -numEHCount 1 \
    -psk "ipsec" \
    -ipsecIDTypeInitiator "ip-subnet-id" \
    -ikeMode "main" \
    -encAlgoPhase2 "3des" \
    -dhGroup "dh2" \
    -userGroups false \
    -groupName "vpngroup" \
    -xauth false \
    -emulatedSubnetIpType "IPv4" \
    -ipsecIDTypeResponder "ip-subnet-id" \
    -modeCfg "none" \
    -hashAlgoPhase1 "md5" \
    -fqdnSeedInitiator "" \
    -peerPublicIP "1.1.1.1" \
    -hashAlgoPhase2 "md5" \
    -pfsGroup "dh2" \
    -encapMode "tunnel" \
    -ahNespMode "ESPOnly" \
    -username "ipsec" \
    -ikeVersion "ikev1" \
    -enablePFS false \
    -emulatedSubnet "40.0.0.0" \
    -authMethod "psk" \
    -testScenario "site2site" \
    -esnIncrementBy "0.0.1.0" \
    -lifeTimePhase1 3600 \
```

Append the IPsec extension to the IP address range.

Configure the IPsec settings.

```

-protectedSubnet          "70.0.0.0" \
-protectedSubnetSuffix    24 \
-prfAlgo                  "md5" \
-password                 "ipsec" \
-peerPublicIPType        "IPv4" \
-name                    "IPSec-R1" \
-emulatedSubnetSuffix     24 \
-enabled                  true \
-encAlgoPhase1           "3des" \
-lifeTimePhase2          28800 \
-fqdnSeedResponder       ""

set IP_R3 [$IPSec_R1 getLowerRelatedRange "IpV4V6Range"]

$IP_R3 config \
  -count                  1 \
  -name                   "IP-R3" \
  -gatewayAddress         "0.0.0.0" \
  -enabled                true \
  -autoMacGeneration      true \
  -mss                    1460 \
  -incrementBy            "0.0.0.1" \
  -prefix                 16 \
  -gatewayIncrement       "0.0.0.0" \
  -gatewayIncrementMode   "perSubnet" \
  -generateStatistics     false \
  -ipAddress              "10.10.0.4" \
  -ipType                 "IPv4"

$Emulated_Router_1 rangeList.clear

```

Configure an IP range for the IPsec tunnels.

```
set ER_R1 [::IxLoad new ixNetEmulatedRouterRange]
# ixNet objects needs to be added in the list
# before they are configured!
$Emulated_Router_1 rangeList.appendItem -object $ER_R1

$ER_R1 config \
  -count 1 \
  -name "ER-R1" \
  -gatewayAddress "0.0.0.0" \
  -enabled true \
  -autoMacGeneration true \
  -mss 1460 \
  -incrementBy "0.0.0.1" \
  -prefix 16 \
  -gatewayIncrement "0.0.0.0" \
  -gatewayIncrementMode "perSubnet" \
  -generateStatistics false \
  -ipAddress "10.10.0.3" \
  -ipType "IPv4"

set MAC_R7 [$ER_R1 getLowerRelatedRange "MacRange"]

$MAC_R7 config \
  -count 1 \
  -name "MAC-R7" \
  -enabled true \
  -mtu 1500 \
  -mac "10:EF:3C:1E:00:00" \
  -incrementBy "00:00:00:00:00:01"
```

Configure an address range for the Emulated Router.

Configure the MAC addresses for the IP range.

## PPPoX Plugin

### SYNOPSIS

### DESCRIPTION

Configures a PPPoX plugin.

### SUBCOMMANDS

### OPTIONS

name

Name of the instance of the plugin.

Default value = "None"

childrenList

Name of the list of next-lower layer plugins.

Default value = "None"

extensionList

Name of the list of protocol extensions.

Default value = "None"

rangeList

Name of the list of IP address ranges used by this plugin. The list must be a `PppoxRangeList` object.

This option is read-only.

Default value = "None"

### EXAMPLE

```
set PPPoX_1 [::IxLoad new ixNetPppoxPlugin]# ixNet objects needs to be added in the
list before they are configured!$MAC_VLAN_10 childrenList.appendItem -object $PPPoX_
1
```

```
$PPPoX_1 config \-name "PPPoX-1"
```

```
$PPPoX_1 childrenList.clear
```

```
$PPPoX_1 extensionList.clear
```

```
$MAC_VLAN_10 extensionList.clear
```

```
$Ethernet_1 extensionList.clear
```

### SEE ALSO

## PppoxPortGroupData

### SYNOPSIS

## DESCRIPTION

Configures the PPPoX network group settings.

## SUBCOMMANDS

### OPTIONS

`activityID`

Activity ID.

Default value = "0"

`activities`

List of activities.

Default Value = "None"

`associates`

Name of the list of associates. This list must an `AssociateList` object.

This option is read only.

Default value = "None"

`overrideGlobalRateControls`

If `false`, the global setup and teardown rate values will be equally divided among the ports.

If `true`, The setup and teardown parameters defined at the port level will override those defined at the global level.

For example, if you have set the initial setup rate to 150 on the global level, and you have defined two ports, these 150 session setups will be evenly distributed across the ports (75 for each). If you then enable Override Global Rate Controls, you can modify the number of session setups for each of the ports (such as changing the distribution from 75-75 to 120-30).

Default value = "False"

`setupRateInitial`

The number of PPP sessions to set up, per second. The default is 300, the minimum is 1, the maximum is 1000.

Default value = "300"

`maxOutstandingRequests`

The maximum number of PPP sessions that can be outstanding at any given time. The minimum is 1, the maximum is 1000.

Default value="300"

`teardownRateInitial`

The number of PPP sessions to tear down, per second. The default is 300, the minimum is 1, the maximum is 1000.

Default value = "300"

`maxOutstandingReleases`

The maximum number of PPP sessions that can be released at any given time. The minimum is 1, the maximum is 1000.

Default value = "300"

`useWaitForCompletionTimeout`

Enables the application to wait for a specified amount of time for the sessions to negotiate before declaring a negotiation timeout.

Default value = "False"

`waitForCompletionTimeout`

If `useWaitForCompletionTimeout` is true, specify the number of seconds that the application will wait for the sessions to negotiate.

The default is 120, the minimum is 1, and the maximum is 65535.

Default value = "120"

`enablePerSessionStatGeneration`

Enables or disables per-session statistics generation. When enabled, PPP protocol statistics are generated during the session negotiation phase of an L2TP or PPP test and written to a CSV file. The CSV file is generated at the end of the session negotiation phase. The concatenated results for each port are returned as a single file.

Statistics are generated only for client ports because server ports do not establish any sessions during the negotiation phase.

Default value = "False"

`perSessionStatFilePrefix`

If `enablePerSessionStatGeneration` is true, specify the prefix to use for the name of the per-session PPP protocol statistics file.

The per-session PPP protocol statistics file names are of the form:

```
StatsFilePrefix_chassis_card_port_TimeStamp_.csv
```

The CSV files are saved in the folder defined by the `setResultDir` option of the `ixTestController` command. See `ixTestController` (see ["ixTestController"](#)).

Default value = "MY\_PREFIX"

`role`

The role that the PPPoX network group plays in the test configuration. Must be one of the choices in the RoleChoices object.

**Note:** A client and a server cannot both be set at the same time on the same network group.

Default value = "client"

`filterDataPlaneBeforeL7`

Default value = "False"

## EXAMPLE

## SEE ALSO

# PLSessionDataBase

## SYNOPSIS

## DESCRIPTION

Configures the PPPoX and L2TP network group settings.

## SUBCOMMANDS

## OPTIONS

`setupRateInitial`

The number of PPP sessions to set up, per second. The default is 300, the minimum is 1, the maximum is 1000.

Default value = "300"

`maxOutstandingRequests`

The maximum number of PPP sessions that can be outstanding at any given time. The minimum is 1, the maximum is 1000.

Default value = "300"



`teardownRateInitial`

The number of PPP sessions to tear down, per second. The default is 300, the minimum is 1, the maximum is 1000.

Default value = "300"

`maxOutstandingReleases`

The maximum number of PPP sessions that can be released at any given time. The minimum is 1, the maximum is 1000.

Default value = "300"

## **EXAMPLE**

## **SEE ALSO**

# **PppoxRangeList**

## **SYNOPSIS**

## **DESCRIPTION**

List of PPPoX ranges. This list must be a list of `PppoxRange` objects.

## **SUBCOMMANDS**

## **OPTIONS**

## **EXAMPLE**

## **SEE ALSO**

## **PppoxAcNameList**

### **SYNOPSIS**

### **DESCRIPTION**

List of access concentrator names. This list must be a list of `PppoxAcName` objects.

### **SUBCOMMANDS**

### **OPTIONS**

### **EXAMPLE**

### **SEE ALSO**

## **PppoxAcMacList**

### **SYNOPSIS**

### **DESCRIPTION**

List of access concentrator MAC addresses. This list must be a list of `PppoxAcMac` objects.

### **SUBCOMMANDS**

### **OPTIONS**

## EXAMPLE

## SEE ALSO

## Pppox Plugin Example

This section shows an example of how to create a PPPoX plugin in the Tcl API.

```
#####
# IxLoad ScriptGen created TCL script
# Network1 serialized using version 4.10.0.79
# PPPoX.tcl made on Aug 14 2008 15:27
#####

set Network1 [::IxLoad new ixNetworkGroup $chassisChain]
$Network1 config \
    -comment          "" \
    -name              "Network1" \
    -macMappingMode   0 \
    -linkLayerOptions 0

$Network1 globalPlugins.clear

set GratARP [::IxLoad new ixNetGratArpPlugin]
# ixNet objects needs to be added in the list
# before they are configured!
$Network1 globalPlugins.appendItem -object $GratARP

$GratARP config \
    -enabled          true \
    -name              "GratARP"
```

Create a network group.

Clear the global plugins list.

Begin appending items to global plugin list.

Optionally, enable Gratuitous ARP.

```

set TCP [::IxLoad new ixNetTCPPlugin]
# ixNet objects needs to be added in the list
# before they are configured!
$Network1 globalPlugins.appendItem -object $TCP

$TCP config \
    -tcp_bic 0 \
    -tcp_tw_recycle true \
    -tcp_retries2 5 \
    -tcp_retries1 3 \
    -tcp_keepalive_time 75 \
    -tcp_moderate_rcvbuf 0 \
    -tcp_rfc1337 false \
    -tcp_ipfrag_time 30 \
    -tcp_rto_max 60000 \
    -tcp_vegas_alpha 2 \
    -tcp_ecn false \
    -tcp_westwood 0 \
    -tcp_rto_min 1000 \
    -tcp_reordering 3 \
    -tcp_vegas_cong_avoid 0 \
    -tcp_keepalive_intvl 7200 \
    -tcp_rmem_max 262144 \
    -tcp_orphan_retries 0 \
    -tcp_max_tw_buckets 180000 \
    -tcp_wmem_default 4096 \
    -tcp_low_latency 0 \
    -tcp_rmem_min 4096 \
    -tcp_adv_win_scale 2 \
    -tcp_wmem_min 4096 \
    -tcp_port_min 1024 \
    -tcp_stdurg false \
    -tcp_port_max 65535 \
    -tcp_fin_timeout 60 \
    -tcp_no_metrics_save false \
    -tcp_dsack true \
    -tcp_mem_high 49152 \
    -tcp_frto 0 \
    -tcp_app_win 31 \
    -ip_no_pmtu_disc false \
    -tcp_window_scaling false \

```

Configure the TCP portion of the stack.

```

set Settings [::IxLoad new ixNetIxLoadSettingsPlugin]
# ixNet objects needs to be added in the list
# before they are configured!
$Network1 globalPlugins.appendItem -object $Settings

$Settings config \
    -teardownInterfaceWithUser      false \
    -name                            "Settings" \
    -interfaceBehavior              0

set Ethernet_1 [$Network1 getL1Plugin]

set my_ixNetEthernetELMPlugin [::IxLoad new ixNetEthernetELMPlugin]
$my_ixNetEthernetELMPlugin config \
    -negotiationType                "master" \
    -negotiateMasterSlave           true

$Ethernet_1 config \
    -advertise10Full                true \
    -name                            "Ethernet-1" \
    -autoNegotiate                  true \
    -advertise100Half               true \
    -advertise10Half                true \
    -speed                          "k100FD" \
    -advertise1000Full              true \
    -advertise100Full               true \
    -cardElm

$my_ixNetEthernetELMPlugin
$Ethernet_1 childrenList.clear

```

Configure the Dynamic  
Control plane settings.

Configure the physical  
layer properties.

```
set MAC_VLAN_10 [::IxLoad new ixNetL2EthernetPlugin]
# ixNet objects needs to be added in the list
# before they are configured!
$Ethernet_1 childrenList.appendItem -object $MAC_VLAN_10

$MAC_VLAN_10 config \
    -name "MAC/VLAN-10"

$MAC_VLAN_10 childrenList.clear

set PPPoX_1 [::IxLoad new ixNetPppoxPlugin]
# ixNet objects needs to be added in the list
# before they are configured!
$MAC_VLAN_10 childrenList.appendItem -object $PPPoX_1

$PPPoX_1 config \
    -name "PPPoX-1"

$PPPoX_1 childrenList.clear
$PPPoX_1 extensionList.clear
$MAC_VLAN_10 extensionList.clear
$Ethernet_1 extensionList.clear
```

Configure the MAC addresses and VLAN tags.

Create the PPPoX plugin.

Clear the lists of extension protocols.

```
#####
# Setting the ranges starting with the plugin on top of the stack
#####
$PPPoX_1 rangeList.clear

set PPPoX_R1 [::IxLoad new ixNetPppoxRange]
# ixNet objects needs to be added in the list
# before they are configured!
$PPPoX_1 rangeList.appendItem -object $PPPoX_R1

$PPPoX_R1 config \
    -serverSignalLoopEncapsulation      false \
    -padrTimeout                         10 \
    -serverBaseIID                      "00:11:22:11:00:00:00:01" \
    -enableEchoReq                       false \
    -authTimeout                         10 \
    -actualRateUpstream                  10 \
    -ncpTimeout                           10 \
    -clientIpIncr                        "0.0.0.1" \
    -lcpOptions                           "LCP Options" \
    -serverNetmaskOptions                 "disableExtension" \
    -serverSignalLoopId                  false \
    -ipv6PoolPrefixLen                   48 \
    -clientSignalLoopChar                 false \
    -clientIIDIncr                       1 \
    -authRetries                          20 \
    -enableMruNegotiation                 false \
    -authType                             "none" \
    -clientNetmask                       "255.0.0.0" \
    -ncpType                              "IPv4" \
    -echoReqInterval                     10 \
    -domainList                           "Domain Groups" \
    -clientBaseIID                       "00:11:11:11:00:00:00:01" \
    -clientNetmaskOptions                 "disableExtension" \
    -clientSignalLoopId                  false \
    -authOptions                          "Authentication Options" \
    -lcpTimeout                           10 \
    -pppoeOptions                         "PPPoE Options" \
    -ncpRetries                           3 \
    -serviceName                          "" \
    -enableRedial                         true \
```

Configure the  
PPPoX plugin.

```

$PPPoX_R1 domainGroupList.clear
$PPPoX_R1 acNameTable.clear
$PPPoX_R1 acMacTable.clear

set MAC_R9 [$PPPoX_R1 getLowerRelatedRange "MacRange"]

$MAC_R9 config \
    -count 1 \
    -name "MAC-R9" \
    -enabled true \
    -mtu 1500 \
    -mac "6A:40:7E:B6:00:00" \
    -incrementBy "00:00:00:00:00:01"

set VLAN_R1 [$PPPoX_R1 getLowerRelatedRange "VlanIdRange"]

$VLAN_R1 config \
    -incrementStep 1 \
    -uniqueCount 4094 \
    -name "VLAN-R1" \
    -innerIncrement 1 \
    -innerUniqueCount 4094 \
    -enabled true \
    -innerFirstId 1 \
    -increment 1 \
    -priority 1 \
    -firstId 1 \
    -innerIncrementStep 1 \
    -idIncrMode 2 \
    -innerEnable false \
    -innerPriority 1

```

Clear the lists of PPPoX plugin child objects, if not used.

Configure the MAC addresses for the PPPoX IP range.

Configure the VLAN tags for the DHCP IP ranges.

## L2TP Plugin

### SYNOPSIS

### DESCRIPTION

Configures an L2TP plugin.

### SUBCOMMANDS



## OPTIONS

name

Name of the instance of the plugin.

Default value = "None"

childrenList

Name of the list of next-lower layer plugins.

Default value = "None"

extensionList

Name of the list of protocol extensions.

Default value = "None"

l2tpRanges

Name of the L2tpRangeList containing the address ranges used by this plugin.

Default value = "None"

## EXAMPLE

```
set L2TP_1 [::IxLoad new ixNetL2tpPlugin]
# ixNet objects needs to be added in the list before they are configured!
$IP_4 childrenList.appendItem -object $L2TP_1

$L2TP_1 config \
-name                "L2TP-1"

$L2TP_1 childrenList.clear

$L2TP_1 extensionList.clear

$IP_4 extensionList.clear

$MAC_VLAN_9 extensionList.clear
```

`$Ethernet_1 extensionList.clear`

## SEE ALSO

# Network Group Settings

## SYNOPSIS

## DESCRIPTION

Configures the L2TP Network Group Settings Parameters.

## SUBCOMMANDS

## OPTIONS

`activityID`

Activity ID.

Default value = "0"

`activities`

List of activities.

Default Value = "None"

`associates`

Name of the list of Associates.

This option is read only.

Default value = "None"

`overrideGlobalRateControls`

If `false`, the global setup and teardown rate values will be equally divided among the ports.

If `true`, The setup and teardown parameters defined at the port level will override those defined at the global level.

---

For example, if you have set the initial setup rate to 150 on the global level, and you have defined two ports, these 150 session setups will be evenly distributed across the ports (75 for each). If you then enable Override Global Rate Controls, you can modify the number of session setups for each of the ports (such as changing the distribution from 75-75 to 120-30).

Default value = "False"

`setupRateInitial`

The number of PPP sessions to set up, per second. The default is 300, the minimum is 1, the maximum is 1000.

Default value = "300"

`maxOutstandingRequests`

The maximum number of PPP sessions that can be outstanding at any given time. The minimum is 1, the maximum is 1000.

Default value="300"

`teardownRateInitial`

The number of PPP sessions to tear down, per second. The default is 300, the minimum is 1, the maximum is 1000.

Default value = "300"

`maxOutstandingReleases`

The maximum number of PPP sessions that can be released at any given time. The minimum is 1, the maximum is 1000.

Default value = "300"

`useWaitForCompletionTimeout`

Enables the application to wait for a specified amount of time for the sessions to negotiate before declaring a negotiation timeout.

Default value = "False"

`waitForCompletionTimeout`

If `useWaitForCompletionTimeout` is true, specify the number of seconds that the application will wait for the sessions to negotiate.

The default is 120, the minimum is 1, and the maximum is 65535.

Default value = "120"

`enablePerSessionStatGeneration`

Enables or disables per-session statistics generation. When enabled, PPP protocol statistics are generated during the session negotiation phase of an L2TP or PPP test and written to a CSV file. The CSV

file is generated at the end of the session negotiation phase. The concatenated results for each port are returned as a single file.

Statistics are generated only for client ports because server ports do not establish any sessions during the negotiation phase.

Default value = "False"

`perSessionStatFilePrefix`

If `enablePerSessionStatGeneration` is true, specify the prefix to use for the name of the per-session PPP protocol statistics file.

The per-session PPP protocol statistics file names are of the form:

```
StatsFilePrefix_chassis_card_port_TimeStamp_.csv
```

The CSV files are saved in this folder:

```
<Install path>\data\result\[UserName]\Per Session Stats PPP_L2TP\
```

Default value = "MY\_PREFIX"

`role`

The role that the L2TP network group plays in the test configuration:

- lac - L2TP Access Concentrator (LAC)
- lns - L2TP Network Server (LNS)

Default value = "lac"

## EXAMPLE

## SEE ALSO

# L2tpSessionData

## SYNOPSIS

## DESCRIPTION

Global L2TP settings.

## SUBCOMMANDS

## OPTIONS

`setupRateInitial`

The number of PPP sessions to set up, per second. The default is 300, the minimum is 1, the maximum is 1000.

Default value = "300"

`maxOutstandingRequests`

The maximum number of PPP sessions that can be outstanding at any given time. The minimum is 1, the maximum is 1000.

Default value = "300"

`teardownRateInitial`

The number of PPP sessions to tear down, per second. The default is 300, the minimum is 1, the maximum is 1000.

Default value = "300"

`maxOutstandingReleases`

The maximum number of PPP sessions that can be released at any given time. The minimum is 1, the maximum is 1000.

Default value = "300"

## EXAMPLE

## SEE ALSO

## Basic parameters

### SYNOPSIS

### DESCRIPTION

Configures the L2TP Basic parameters.

### SUBCOMMANDS

## OPTIONS

tunnelDestinationIp

Defines the base address to be used for the L2TP tunnel destinations.

Default value = "10.10.10.1"

tunnelIncrementBy

Defines the increment to be used for enumerating all the addresses in the destination range.

Default value = "0.0.0.1"

sessionsPerTunnel

The number of PPP sessions that each L2TP tunnel may carry.

The default is 1, the minimum is 1, and the maximum is 32000.

Default value = "1"

## EXAMPLE

```
$L2TP_1 l2tpRanges.clear
```

set L2TP\_R1 [::IxLoad new ixNetL2tpRange]# ixNet objects needs to be added in the list before they are configured!  
\$L2TP\_1 l2tpRanges.appendItem -object \$L2TP\_R1

```
$L2TP_R1 config \-authTimeout 10 \-lacToLNSMapping  
"gateway" \-authRetries 20 \-authType  
"none" \-sessionsPerTunnel 1 \-echoReqInterval  
10 \-domainList "Domain Groups" \-peerHostName  
"ixia" \-useHiddenAVPs false \-incrementBy  
1 \-ncpRetries 3 \-serverPrimaryDnsAddress  
"10.10.10.10" \-clientDnsOptions "disableExtension" \-  
enableHelloRequest false \-lcpTermTimeout  
15 \-baseLnsIp "0.0.0.0" \-name  
"L2TP-R1" \-lcpTermRetries 3 \-serverIIDIncr  
1 \-rxConnectSpeed 268435456 \-clientBaseIID  
"00:11:11:11:00:00:00:01" \-numSessions 1 \-  
tunnelAuthentication "none" \-serverBaseIID  
"00:11:22:11:00:00:00:01" \-ncpTimeout 10 \-  
tunnelDestinationIp "10.10.10.1" \-ipv6PoolPrefixLen  
48 \-l2tpAuthOptions "L2PT Authentication Options" \-  
clientIIDIncr 1 \-udpDestinationPort  
1701 \-lacSecret "ixia" \-ipIncrementOctet  
4 \-ncpType "IPv4" \-lnsIpList  
"LNS IPs" \-authOptions "Authentication Options" \-
```

```

offsetByte                0 \-enableRedial
false \-lcpRetries        3 \-maxRetransmitInterval
8 \-chapName              "user" \-useSequenceNoInPayload
false \-serverSecondaryDnsAddress "11.11.11.11" \-basicOptions
"L2PT Options" \-lacHostName      "ixia" \-serverNetmask
"255.255.255.0" \-bearerCapability "3" \-receiveWindowSize
10 \-serverDnsOptions      "disableExtension" \-
clientPrimaryDnsAddress    "8.8.8.8" \-lnsIpNumber
1 \-tunnelIncrementBy     "0.0.0.1" \-chapSecret
"secret" \-enableEchoReq    false \-lcpOptions
"LCP Options" \-serverNetmaskOptions "disableExtension" \-
helloRequestInterval      60 \-clientNetmask
"255.0.0.0" \-initRetransmitInterval 2 \-clientNetmaskOptions
"disableExtension" \-sessionAllocMethod "nextTunnel" \-
enableControlChecksum     true \-framingCapability
"1" \-useLengthBitInPayload false \-ipv6PoolPrefix
"1:1:1::" \-enableEchoRsp    true \-serverIpIncr
"0.0.0.0" \-papPassword     "password" \-txConnectSpeed
268435456 \-ipv6AddrPrefixLen 64 \-redialInterval
10 \-clientBaseIp         "1.1.1.1" \-domainToIpList
"Domain To LNS" \-controlMsgsRetryCounter 30 \-
clientSecondaryDnsAddress "9.9.9.9" \-enabled
true \-mtu                 1492 \-serverBaseIp
"2.2.2.2" \-noCallTimeout   5 \-clientIpIncr
"0.0.0.1" \-dataPlaneOptions "Data Plane Options" \-
enableDataChecksum        false \-enableProxy
true \-lcpTimeout          10 \-enableDomainGroups
false \-bearerType         "2" \-offsetLength
0 \-udpSourcePort          1701 \-maxRedialAttempts
20 \-sessionStartId       1 \-papUser
"user" \-controlPlaneOptions "Control Plane Options" \-
useOffsetBitInPayload     false \-tunnelStartId
1 \-useMagic               true

```

```
$L2TP_R1 domainGroupList.clear
```

```
$L2TP_R1 lnsIpAddresses.clear
```

```
set IP_R4 [$L2TP_R1 getLowerRelatedRange "IpV4V6Range"]
```

```

$IP_R4 config \-count                1 \-name
"IP-R4" \-gatewayAddress              "0.0.0.0" \-enabled
true \-autoMacGeneration              true \-mss
1460 \-incrementBy                    "0.0.0.1" \-prefix
16 \-gatewayIncrement                 "0.0.0.0" \-gatewayIncrementMode

```

```

"perSubnet" \-generateStatistics           false \-ipAddress
"10.10.0.5" \-ipType                       "IPv4"

set MAC_R8 [$IP_R4 getLowerRelatedRange "MacRange"]

$MAC_R8 config \-count                     1 \-name
"MAC-R8" \-enabled                         true \-mtu
1500 \-mac                                 "00:0A:0A:00:05:00" \-incrementBy
"00:00:00:00:00:01"

set VLAN_R1 [$IP_R4 getLowerRelatedRange "VlanIdRange"]

$VLAN_R1 config \-incrementStep            1 \-uniqueCount
4094 \-name                                "VLAN-R1" \-innerIncrement
1 \-innerUniqueCount                      4094 \-enabled
true \-innerFirstId                       1 \-increment
1 \-priority                               1 \-firstId
1 \-innerIncrementStep                    1 \-idIncrMode
2 \-innerEnable                           false \-innerPriority
1

```

**SEE ALSO**

## L2TP Control Plane

**SYNOPSIS**

**DESCRIPTION**

Configures the L2TP Control Plane parameters.

**SUBCOMMANDS**

**OPTIONS**

sessionsPerTunnel

The number of PPP sessions that each L2TP tunnel may carry.

The default is 1, the minimum is 1, and the maximum is 32000.



Default value = "1"

tunnelStartId

A unique identifier for the L2TP tunnel.

The default is 1; the minimum is 1; and the maximum is 65,535.

Min=1, Max=65535, Default=1

noCallTimeout

The amount of time, in seconds to wait to receive an L2TP request for connection. If it does not receive a call within this time, the tunnel is closed. The default is 5, the minimum is 1, and the maximum is 180.

Default value = "5"

enableHelloRequest

If checked, Hello messages are sent to confirm that a tunnel is still up.

Default value = "False"

helloRequestInterval

If Hello Requests are enabled, this value determines the amount of time that can elapse between the time the most recent control or data message are sent, and the time a Hello message is sent. The default is 60, the minimum is 1, and the maximum is 180.

Default value = "60"

bearerCapability

Indicates to the DUT the bearer device types from which incoming calls will be accepted. You can set this parameter to the following values:

- Analog: advertises its bearer device type as analog only.
- Digital: advertises its bearer device type as digital only.
- Both: advertises its bearer device types as analog and digital.

The default value is Both.

Value	Description
1	Digital: advertises its bearer device type as digital only.
2	Analog: advertises its bearer device type as analog only.
3	Both: advertises its bearer device types as analog and digital.

Default value = "3"

bearerType

Device type requested for outgoing calls. You can set this parameter to the following values:

- Analog: requests analog device capability.
- Digital: requests digital device capability.

The default value is Digital.

Value	Description
1	Digital: requests digital device capability.
2	Analog: requests analog device capability.

Default value = "2"

`controlMsgsRetryCounter`

Number of times a control message for which an acknowledgment has not been received will be retransmitted. The default is 30, the minimum is 1, and the maximum is 100.

Default value = "30"

`initRetransmitInterval`

Initial amount of time that can elapse before an unacknowledged control message is retransmitted.

If a control message is retransmitted and still does not receive a reply from the DUT, the control message will be retransmitted at increasingly longer intervals until it receives a reply. The Max Retransmit Interval parameter establishes the upper limit on retransmit interval.

The default is 2, the minimum is 1, and the maximum is 65535.

Default value = "2"

`maxRetransmitInterval`

Unacknowledged control messages are retransmitted.

If a control message is transmitted at the Maximum Retransmit Interval and still does not receive a reply, the associated tunnel is torn down along with the PPP sessions within it.

The default is 8, the minimum is 1, and the maximum is 65535.

Default value = "8"

`receiveWindowSize`

Configures the size of the sliding window used for managing control message transmission. The values for this parameter are expressed in units of unacknowledged control messages. For example, if you set this parameter to 4, the DUT can send control messages until it has four messages for which it is waiting for acknowledgments. At that point, it must wait for one or more of the messages to be acknowledged before it can send any new control messages.

The default is 10, the minimum is 1, and the maximum is 2048.

Default value = "10"

`enableRedial`

If the L2TP link goes down and this parameter is enabled, the DUT will be redialed to reestablish the link.

Default value = "False"

`redialInterval`

Number of seconds that can elapse between attempts to redial the DUT to re-establish a downed L2TP link. The default is 10, the minimum is 1, and the maximum is 65535.

Default value = "10"

`maxRedialAttempts`

The maximum number attempts IxLoad will make to redial the DUT to re-establish a downed L2TP link. The default is 20, the minimum is 1, and the maximum is 65535.

Default value = "20"

`sessionAllocMethod`

Method for allocating sessions among tunnels.

Value	Description
<code>nextTunnel</code>	Distribute sessions among tunnels
<code>fillTunnel</code>	Fill tunnels in order

Default value = "nextTunnel"

`framingCapability`

Framing capability.

Value	Description
1	Synchronous
2	Asynchronous

Default value = "1"

### EXAMPLE

```
$L2TP_1 l2tpRanges.clear
```

```
set L2TP_R1 [::IxLoad new ixNetL2tpRange]# ixNet objects needs to be added in the
```

```
list before they are configured!$L2TP_1 l2tpRanges.appendItem -object $L2TP_R1
```

```
$L2TP_R1 config \-authTimeout 10 \-lacToLNSMapping
"gateway" \-authRetries 20 \-authType
"none" \-sessionsPerTunnel 1 \-echoReqInterval
10 \-domainList "Domain Groups" \-peerHostName
"ixia" \-useHiddenAVPs false \-incrementBy
1 \-ncpRetries 3 \-serverPrimaryDnsAddress
"10.10.10.10" \-clientDnsOptions "disableExtension" \-
enableHelloRequest false \-lcpTermTimeout
15 \-baseLnsIp "0.0.0.0" \-name
"L2TP-R1" \-lcpTermRetries 3 \-serverIIDIncr
1 \-rxConnectSpeed 268435456 \-clientBaseIID
"00:11:11:11:00:00:00:01" \-numSessions 1 \-
tunnelAuthentication "none" \-serverBaseIID
"00:11:22:11:00:00:00:01" \-ncpTimeout 10 \-
tunnelDestinationIp "10.10.10.1" \-ipv6PoolPrefixLen
48 \-l2tpAuthOptions "L2PT Authentication Options" \-
clientIIDIncr 1 \-udpDestinationPort
1701 \-lacSecret "ixia" \-ipIncrementOctet
4 \-ncpType "IPv4" \-lnsIpList
"LNS IPs" \-authOptions "Authentication Options" \-
offsetByte 0 \-enableRedial
false \-lcpRetries 3 \-maxRetransmitInterval
8 \-chapName "user" \-useSequenceNoInPayload
false \-serverSecondaryDnsAddress "11.11.11.11" \-basicOptions
"L2PT Options" \-lacHostName "ixia" \-serverNetmask
"255.255.255.0" \-bearerCapability "3" \-receiveWindowSize
10 \-serverDnsOptions "disableExtension" \-
clientPrimaryDnsAddress "8.8.8.8" \-lnsIpNumber
1 \-tunnelIncrementBy "0.0.0.1" \-chapSecret
"secret" \-enableEchoReq false \-lcpOptions
"LCP Options" \-serverNetmaskOptions "disableExtension" \-
helloRequestInterval 60 \-clientNetmask
"255.0.0.0" \-initRetransmitInterval 2 \-clientNetmaskOptions
"disableExtension" \-sessionAllocMethod "nextTunnel" \-
enableControlChecksum true \-framingCapability
"1" \-useLengthBitInPayload false \-ipv6PoolPrefix
"1:1:1::" \-enableEchoRsp true \-serverIpIncr
"0.0.0.0" \-papPassword "password" \-txConnectSpeed
268435456 \-ipv6AddrPrefixLen 64 \-redialInterval
10 \-clientBaseIp "1.1.1.1" \-domainToIpList
"Domain To LNS" \-controlMsgsRetryCounter 30 \-
clientSecondaryDnsAddress "9.9.9.9" \-enabled
true \-mtu 1492 \-serverBaseIp
"2.2.2.2" \-noCallTimeout 5 \-clientIpIncr
```

```

"0.0.0.1" \-dataPlaneOptions          "Data Plane Options" \-
enableDataChecksum                    false \-enableProxy
true \-lcpTimeout                      10 \-enableDomainGroups
false \-bearerType                     "2" \-offsetLength
0 \-udpSourcePort                      1701 \-maxRedialAttempts
20 \-sessionStartId                   1 \-papUser
"user" \-controlPlaneOptions          "Control Plane Options" \-
useOffsetBitInPayload                  false \-tunnelStartId
1 \-useMagic                           true

$L2TP_R1 domainGroupList.clear

$L2TP_R1 lnsIpAddresses.clear

set IP_R4 [$L2TP_R1 getLowerRelatedRange "IPv4V6Range"]

$IP_R4 config \-count                  1 \-name
"IP-R4" \-gatewayAddress                "0.0.0.0" \-enabled
true \-autoMacGeneration                true \-mss
1460 \-incrementBy                      "0.0.0.1" \-prefix
16 \-gatewayIncrement                  "0.0.0.0" \-gatewayIncrementMode
"perSubnet" \-generateStatistics        false \-ipAddress
"10.10.0.5" \-ipType                    "IPv4"

set MAC_R8 [$IP_R4 getLowerRelatedRange "MacRange"]

$MAC_R8 config \-count                  1 \-name
"MAC-R8" \-enabled                      true \-mtu
1500 \-mac                              "00:0A:0A:00:05:00" \-incrementBy
"00:00:00:00:00:01"

set VLAN_R1 [$IP_R4 getLowerRelatedRange "VlanIdRange"]

$VLAN_R1 config \-incrementStep          1 \-uniqueCount
4094 \-name                             "VLAN-R1" \-innerIncrement
1 \-innerUniqueCount                    4094 \-enabled
true \-innerFirstId                     1 \-increment
1 \-priority                            1 \-firstId
1 \-innerIncrementStep                  1 \-idIncrMode
2 \-innerEnable                         false \-innerPriority
1

```

## SEE ALSO

## L2TP Data Plane

### SYNOPSIS

### DESCRIPTION

Configures the L2TP Range Parameters.

### SUBCOMMANDS

#### OPTIONS

`enableControlChecksum`

Enables the use of UDP checksums on control messages.

The L2TP RFC (RFC 2661) recommends that UDP checksums always be enabled on control packets.

Default value = "True"

`enableDataChecksum`

Enables the use of UDP checksums on data messages.

Default value = "False"

`udpSourcePort`

The UDP port used to send requests to the DUT for L2TP connections. The well-known port number for L2TP is 1701.

Default value = "1701"

`udpDestinationPort`

The UDP port that the DUT uses to listen for L2TP connection requests. The well-known port number for L2TP is 1701.

Default value = "1701"

`useLengthBitInPayload`

If `true`, sets the Length bit in data messages, adding the Length field to the header and indicating that it is present.

Default value = "False"

useOffsetBitInPayload

If `true`, sets the Offset bit in data messages, adding the Offset Length field to the header and indicating that it is present.

Default value = "False"

offsetByte

If `useOffsetBitInPayload` is `true`, the Offset Byte field specifies the byte value used to pad the header from the end of the Offset Length field to the beginning of the payload. The default is 0, the minimum is 0, and the maximum is 255.

Default value = "0"

offsetLength

The Offset Length field specifies the number of octets past the L2TP header at which the payload data starts. The default is 0, the minimum is 0, and the maximum is 255.

Default value = "0"

useSequenceNoInPayload

If `true`, sets the Sequence bit in data messages, adding the Sequence Number fields to the header and indicating that they are present.

Default value = "False"

## EXAMPLE

```
$L2TP_1 l2tpRanges.clear
```

```
set L2TP_R1 [::IxLoad new ixNetL2tpRange]# ixNet objects needs to be added in the
list before they are configured!$L2TP_1 l2tpRanges.appendItem -object $L2TP_R1
```

```
$L2TP_R1 config \-authTimeout 10 \-lacToLNSMapping
"gateway" \-authRetries 20 \-authType
"none" \-sessionsPerTunnel 1 \-echoReqInterval
10 \-domainList "Domain Groups" \-peerHostName
"ixia" \-useHiddenAVPs false \-incrementBy
1 \-ncpRetries 3 \-serverPrimaryDnsAddress
"10.10.10.10" \-clientDnsOptions "disableExtension" \-
enableHelloRequest false \-lcpTermTimeout
15 \-baseLnsIp "0.0.0.0" \-name
"L2TP-R1" \-lcpTermRetries 3 \-serverIIDIncr
1 \-rxConnectSpeed 268435456 \-clientBaseIID
"00:11:11:11:00:00:00:01" \-numSessions 1 \-
```

```

tunnelAuthentication "none" \-serverBaseIID
"00:11:22:11:00:00:00:01" \-ncpTimeout 10 \-
tunnelDestinationIp "10.10.10.1" \-ipv6PoolPrefixLen
48 \-l2tpAuthOptions "L2PT Authentication Options" \-
clientIIDIncr 1 \-udpDestinationPort
1701 \-lacSecret "ixia" \-ipIncrementOctet
4 \-ncpType "IPv4" \-lnsIpList
"LNS IPs" \-authOptions "Authentication Options" \-
offsetByte 0 \-enableRedial
false \-lcpRetries 3 \-maxRetransmitInterval
8 \-chapName "user" \-useSequenceNoInPayload
false \-serverSecondaryDnsAddress "11.11.11.11" \-basicOptions
"L2PT Options" \-lacHostName "ixia" \-serverNetmask
"255.255.255.0" \-bearerCapability "3" \-receiveWindowSize
10 \-serverDnsOptions "disableExtension" \-
clientPrimaryDnsAddress "8.8.8.8" \-lnsIpNumber
1 \-tunnelIncrementBy "0.0.0.1" \-chapSecret
"secret" \-enableEchoReq false \-lcpOptions
"LCP Options" \-serverNetmaskOptions "disableExtension" \-
helloRequestInterval 60 \-clientNetmask
"255.0.0.0" \-initRetransmitInterval 2 \-clientNetmaskOptions
"disableExtension" \-sessionAllocMethod "nextTunnel" \-
enableControlChecksum true \-framingCapability
"1" \-useLengthBitInPayload false \-ipv6PoolPrefix
"1:1:1::" \-enableEchoRsp true \-serverIpIncr
"0.0.0.0" \-papPassword "password" \-txConnectSpeed
268435456 \-ipv6AddrPrefixLen 64 \-redialInterval
10 \-clientBaseIp "1.1.1.1" \-domainToIpList
"Domain To LNS" \-controlMsgsRetryCounter 30 \-
clientSecondaryDnsAddress "9.9.9.9" \-enabled
true \-mtu 1492 \-serverBaseIp
"2.2.2.2" \-noCallTimeout 5 \-clientIpIncr
"0.0.0.1" \-dataPlaneOptions "Data Plane Options" \-
enableDataChecksum false \-enableProxy
true \-lcpTimeout 10 \-enableDomainGroups
false \-bearerType "2" \-offsetLength
0 \-udpSourcePort 1701 \-maxRedialAttempts
20 \-sessionStartId 1 \-papUser
"user" \-controlPlaneOptions "Control Plane Options" \-
useOffsetBitInPayload false \-tunnelStartId
1 \-useMagic true

```

```
$L2TP_R1 domainGroupList.clear
```

```
$L2TP_R1 lnsIpAddresses.clear
```



```

set IP_R4 [$L2TP_R1 getLowerRelatedRange "IPv4V6Range"]

$IP_R4 config \-count                1 \-name
"IP-R4" \-gatewayAddress             "0.0.0.0" \-enabled
true \-autoMacGeneration             true \-mss
1460 \-incrementBy                   "0.0.0.1" \-prefix
16 \-gatewayIncrement                "0.0.0.0" \-gatewayIncrementMode
"perSubnet" \-generateStatistics     false \-ipAddress
"10.10.0.5" \-ipType                 "IPv4"

set MAC_R8 [$IP_R4 getLowerRelatedRange "MacRange"]

$MAC_R8 config \-count                1 \-name
"MAC-R8" \-enabled                   true \-mtu
1500 \-mac                            "00:0A:0A:00:05:00" \-incrementBy
"00:00:00:00:00:01"

set VLAN_R1 [$IP_R4 getLowerRelatedRange "VlanIdRange"]

$VLAN_R1 config \-incrementStep       1 \-uniqueCount
4094 \-name                           "VLAN-R1" \-innerIncrement
1 \-innerUniqueCount                 4094 \-enabled
true \-innerFirstId                  1 \-increment
1 \-priority                          1 \-firstId
1 \-innerIncrementStep               1 \-idIncrMode
2 \-innerEnable                       false \-innerPriority
1

```

**SEE ALSO****L2TP Authentication****SYNOPSIS****DESCRIPTION**

Configures the L2TP Range Parameters.

## SUBCOMMANDS

### OPTIONS

peerHostName

On LAC ports, this is a text string identifying IxLoad to the DUT for the purposes of Hidden AVPs and Tunnel Authentication. This text string is also used for the hostname AVP. The default value is *ixia*. The text string can have a maximum of 32 characters.

On LNS ports, this is the hostname expected by the LNS in authentication.

Default value = "ixia"

tunnelAuthentication

Enables a LAC or LNS to authenticate the identity of a peer it is contacting or being contacted by during control connection establishment.

If Tunnel Authentication is enabled, the hosts exchange control messages that include the host names and a shared secret. If the expected response and response received do not match, the tunnel will not be established.

To use Tunnel Authentication, you must also configure the `lacHostName` and `lacSecret` fields, which define the shared secret for a host.

Value	Description
none	Tunnel Authentication Disabled
hostname	Authenticate Hostname

Default value = "none"

useHiddenAVPs

If true, Attribute Value Pair hiding is enabled. This enables the use of hidden AVPs, Attribute-Value Pairs (parameters and values) within control messages that are protected by encryption.

Hiding AVPs is done to hide sensitive control message data such as user passwords or user IDs.

To use Hidden AVPs, you must also configure the *Host* and *Secret* fields, which define the shared secret for a host.

Default value = "False"

### EXAMPLE

```
$L2TP_1 l2tpRanges.clear
```

```
set L2TP_R1 [::IxLoad new ixNetL2tpRange]# ixNet objects needs to be added in the
```

list before they are configured!  
`$L2TP_R1 l2tpRanges.appendItem -object $L2TP_R1`

```

$L2TP_R1 config \-authTimeout 10 \-lacToLNSMapping
"gateway" \-authRetries 20 \-authType
"none" \-sessionsPerTunnel 1 \-echoReqInterval
10 \-domainList "Domain Groups" \-peerHostName
"ixia" \-useHiddenAVPs false \-incrementBy
1 \-ncpRetries 3 \-serverPrimaryDnsAddress
"10.10.10.10" \-clientDnsOptions "disableExtension" \-
enableHelloRequest false \-lcpTermTimeout
15 \-baseLnsIp "0.0.0.0" \-name
"L2TP-R1" \-lcpTermRetries 3 \-serverIIDIncr
1 \-rxConnectSpeed 268435456 \-clientBaseIID
"00:11:11:11:00:00:00:01" \-numSessions 1 \-
tunnelAuthentication "none" \-serverBaseIID
"00:11:22:11:00:00:00:01" \-ncpTimeout 10 \-
tunnelDestinationIp "10.10.10.1" \-ipv6PoolPrefixLen
48 \-l2tpAuthOptions "L2PT Authentication Options" \-
clientIIDIncr 1 \-udpDestinationPort
1701 \-lacSecret "ixia" \-ipIncrementOctet
4 \-ncpType "IPv4" \-lnsIpList
"LNS IPs" \-authOptions "Authentication Options" \-
offsetByte 0 \-enableRedial
false \-lcpRetries 3 \-maxRetransmitInterval
8 \-chapName "user" \-useSequenceNoInPayload
false \-serverSecondaryDnsAddress "11.11.11.11" \-basicOptions
"L2PT Options" \-lacHostName "ixia" \-serverNetmask
"255.255.255.0" \-bearerCapability "3" \-receiveWindowSize
10 \-serverDnsOptions "disableExtension" \-
clientPrimaryDnsAddress "8.8.8.8" \-lnsIpNumber
1 \-tunnelIncrementBy "0.0.0.1" \-chapSecret
"secret" \-enableEchoReq false \-lcpOptions
"LCP Options" \-serverNetmaskOptions "disableExtension" \-
helloRequestInterval 60 \-clientNetmask
"255.0.0.0" \-initRetransmitInterval 2 \-clientNetmaskOptions
"disableExtension" \-sessionAllocMethod "nextTunnel" \-
enableControlChecksum true \-framingCapability
"1" \-useLengthBitInPayload false \-ipv6PoolPrefix
"1:1:1::" \-enableEchoRsp true \-serverIpIncr
"0.0.0.0" \-papPassword "password" \-txConnectSpeed
268435456 \-ipv6AddrPrefixLen 64 \-redialInterval
10 \-clientBaseIp "1.1.1.1" \-domainToIpList
"Domain To LNS" \-controlMsgsRetryCounter 30 \-
clientSecondaryDnsAddress "9.9.9.9" \-enabled
true \-mtu 1492 \-serverBaseIp
"2.2.2.2" \-noCallTimeout 5 \-clientIpIncr

```

```

"0.0.0.1" \-dataPlaneOptions                "Data Plane Options" \-
enableDataChecksum                          false \-enableProxy
true \-lcpTimeout                           10 \-enableDomainGroups
false \-bearerType                          "2" \-offsetLength
0 \-udpSourcePort                           1701 \-maxRedialAttempts
20 \-sessionStartId                         1 \-papUser
"user" \-controlPlaneOptions                "Control Plane Options" \-
useOffsetBitInPayload                       false \-tunnelStartId
1 \-useMagic                                 true

$L2TP_R1 domainGroupList.clear

$L2TP_R1 lnsIpAddresses.clear

set IP_R4 [$L2TP_R1 getLowerRelatedRange "IpV4V6Range"]

$IP_R4 config \-count                       1 \-name
"IP-R4" \-gatewayAddress                    "0.0.0.0" \-enabled
true \-autoMacGeneration                   true \-mss
1460 \-incrementBy                          "0.0.0.1" \-prefix
16 \-gatewayIncrement                       "0.0.0.0" \-gatewayIncrementMode
"perSubnet" \-generateStatistics            false \-ipAddress
"10.10.0.5" \-ipType                        "IPv4"

set MAC_R8 [$IP_R4 getLowerRelatedRange "MacRange"]

$MAC_R8 config \-count                     1 \-name
"MAC-R8" \-enabled                          true \-mtu
1500 \-mac                                   "00:0A:0A:00:05:00" \-incrementBy
"00:00:00:00:00:01"

set VLAN_R1 [$IP_R4 getLowerRelatedRange "VlanIdRange"]

$VLAN_R1 config \-incrementStep              1 \-uniqueCount
4094 \-name                                  "VLAN-R1" \-innerIncrement
1 \-innerUniqueCount                        4094 \-enabled
true \-innerFirstId                          1 \-increment
1 \-priority                                 1 \-firstId
1 \-innerIncrementStep                       1 \-idIncrMode
2 \-innerEnable                             false \-innerPriority
1

```

**SEE ALSO****LNS****SYNOPSIS****DESCRIPTION**

Configures the L2TP LNS Parameters.

**SUBCOMMANDS****OPTIONS**

`lacToLNSMapping`

This parameter defines how the LAC (DUT) accesses the LNS (Ixia port).

Value	Description
<code>domain</code>	Through Domain: The LAC maps to the LNS through one of the Domain-to-LNS mappings defined on the Domain to LNS dialog (access to this dialog is through the <i>Domain to LNS</i> column).
<code>gateway</code>	Through Gateway: The LAC maps to the LNS through the gateway specified in the IP tab.

Default value = "gateway"

`lnsIpNumber`

The number of IP addresses that will be created to simulate an LNS. The default is 1, the minimum is 1, and the maximum is 65535.

Default value = "1"

`baseLnsIp`

The first IP address that will be used to simulate an LNS.

Default value = "0.0.0.0"

`incrementBy`

The amount of increase between each incremented IP address.

Default value = "1"

ipIncrementOctet

The octet in the Base LNS IP address that is incremented to create additional IP addresses. Octets are numbered 1 to 4 from left (most-significant) to right (least-significant).

Default value = "4"

lnsIpList

Name of the list of LNS IP addresses.

Default value = "LNS IPs"

domainToIpList

Default value = "Domain To LNS"

### EXAMPLE

```
$L2TP_1 l2tpRanges.clear
```

set L2TP\_R1 [::IxLoad new ixNetL2tpRange]# ixNet objects needs to be added in the list before they are configured!  
`$L2TP_1 l2tpRanges.appendItem -object $L2TP_R1`

```
$L2TP_R1 config \-authTimeout 10 \-lacToLNSMapping
"gateway" \-authRetries 20 \-authType
"none" \-sessionsPerTunnel 1 \-echoReqInterval
10 \-domainList "Domain Groups" \-peerHostName
"ixia" \-useHiddenAVPs false \-incrementBy
1 \-ncpRetries 3 \-serverPrimaryDnsAddress
"10.10.10.10" \-clientDnsOptions "disableExtension" \-
enableHelloRequest false \-lcpTermTimeout
15 \-baseLnsIp "0.0.0.0" \-name
"L2TP-R1" \-lcpTermRetries 3 \-serverIIDIncr
1 \-rxConnectSpeed 268435456 \-clientBaseIID
"00:11:11:11:00:00:00:01" \-numSessions 1 \-
tunnelAuthentication "none" \-serverBaseIID
"00:11:22:11:00:00:00:01" \-ncpTimeout 10 \-
tunnelDestinationIp "10.10.10.1" \-ipv6PoolPrefixLen
48 \-l2tpAuthOptions "L2PT Authentication Options" \-
clientIIDIncr 1 \-udpDestinationPort
1701 \-lacSecret "ixia" \-ipIncrementOctet
4 \-ncpType "IPV4" \-lnsIpList
"LNS IPs" \-authOptions "Authentication Options" \-
offsetByte 0 \-enableRedial
false \-lcpRetries 3 \-maxRetransmitInterval
8 \-chapName "user" \-useSequenceNoInPayload
false \-serverSecondaryDnsAddress "11.11.11.11" \-basicOptions
```

```

"L2PT Options" \-lacHostName "ixia" \-serverNetmask
"255.255.255.0" \-bearerCapability "3" \-receiveWindowSize
10 \-serverDnsOptions "disableExtension" \-
clientPrimaryDnsAddress "8.8.8.8" \-lnsIpNumber
1 \-tunnelIncrementBy "0.0.0.1" \-chapSecret
"secret" \-enableEchoReq false \-lcpOptions
"LCP Options" \-serverNetmaskOptions "disableExtension" \-
helloRequestInterval 60 \-clientNetmask
"255.0.0.0" \-initRetransmitInterval 2 \-clientNetmaskOptions
"disableExtension" \-sessionAllocMethod "nextTunnel" \-
enableControlChecksum true \-framingCapability
"1" \-useLengthBitInPayload false \-ipv6PoolPrefix
"1:1:1::" \-enableEchoRsp true \-serverIpIncr
"0.0.0.0" \-papPassword "password" \-txConnectSpeed
268435456 \-ipv6AddrPrefixLen 64 \-redialInterval
10 \-clientBaseIp "1.1.1.1" \-domainToIpList
"Domain To LNS" \-controlMsgsRetryCounter 30 \-
clientSecondaryDnsAddress "9.9.9.9" \-enabled
true \-mtu 1492 \-serverBaseIp
"2.2.2.2" \-noCallTimeout 5 \-clientIpIncr
"0.0.0.1" \-dataPlaneOptions "Data Plane Options" \-
enableDataChecksum false \-enableProxy
true \-lcpTimeout 10 \-enableDomainGroups
false \-bearerType "2" \-offsetLength
0 \-udpSourcePort 1701 \-maxRedialAttempts
20 \-sessionStartId 1 \-papUser
"user" \-controlPlaneOptions "Control Plane Options" \-
useOffsetBitInPayload false \-tunnelStartId
1 \-useMagic true

```

```
$L2TP_R1 domainGroupList.clear
```

```
$L2TP_R1 lnsIpAddresses.clear
```

```
set IP_R4 [$L2TP_R1 getLowerRelatedRange "IpV4V6Range"]
```

```

$IP_R4 config \-count 1 \-name
"IP-R4" \-gatewayAddress "0.0.0.0" \-enabled
true \-autoMacGeneration true \-mss
1460 \-incrementBy "0.0.0.1" \-prefix
16 \-gatewayIncrement "0.0.0.0" \-gatewayIncrementMode
"perSubnet" \-generateStatistics false \-ipAddress
"10.10.0.5" \-ipType "IPv4"

```

```
set MAC_R8 [$IP_R4 getLowerRelatedRange "MacRange"]
```

```
$MAC_R8 config \-count 1 \-name
"MAC-R8" \-enabled true \-mtu
1500 \-mac "00:0A:0A:00:05:00" \-incrementBy
"00:00:00:00:00:01"
```

```
set VLAN_R1 [$IP_R4 getLowerRelatedRange "VlanIdRange"]
```

```
$VLAN_R1 config \-incrementStep 1 \-uniqueCount
4094 \-name "VLAN-R1" \-innerIncrement
1 \-innerUniqueCount 4094 \-enabled
true \-innerFirstId 1 \-increment
1 \-priority 1 \-firstId
1 \-innerIncrementStep 1 \-idIncrMode
2 \-innerEnable false \-innerPriority
1
```

**SEE ALSO**

## L2tp Plugin Example

This section shows an example of how to create an L2TP plugin in the Tcl API.



```
#####
# IxLoad ScriptGen created TCL script
# Network1 serialized using version 4.10.0.79
# LZTP.tcl made on Aug 14 2008 15:26
#####

set Network1 [::IxLoad new ixNetworkGroup $chassisChain]
$Network1 config \
    -comment          "" \
    -name              "Network1" \
    -macMappingMode    0 \
    -linkLayerOptions  0

$Network1 globalPlugins.clear

Begin appending items to global plugin list.

set GratARP [::IxLoad new ixNetGratArpPlugin]
# ixNet objects needs to be added in the list
# before they are configured!
$Network1 globalPlugins.appendItem -object $GratARP

$GratARP config \
    -enabled          true \
    -name              "GratARP"
```

Create a network group.

Clear the global plugins list.

Begin appending items to global plugin list.

Optionally, enable Gratuitous ARP.

```

set TCP [::IxLoad new ixNetTCPPlugin]
# ixNet objects needs to be added in the list
# before they are configured!
$Network1 globalPlugins.appendItem -object $TCP

```

Configure the TCP  
portion of the stack.

```

$TCP config \
  -tcp_bic 0 \
  -tcp_tw_recycle true \
  -tcp_retries2 5 \
  -tcp_retries1 3 \
  -tcp_keepalive_time 75 \
  -tcp_moderate_rcvbuf 0 \
  -tcp_rfc1337 false \
  -tcp_ipfrag_time 30 \
  -tcp_rto_max 60000 \
  -tcp_vegas_alpha 2 \
  -tcp_ecn false \
  -tcp_westwood 0 \
  -tcp_rto_min 1000 \
  -tcp_reordering 3 \
  -tcp_vegas_cong_avoid 0 \
  -tcp_keepalive_intvl 7200 \
  -tcp_rmem_max 262144 \
  -tcp_orphan_retries 0 \
  -tcp_max_tw_buckets 180000 \
  -tcp_wmem_default 4096 \
  -tcp_low_latency 0 \
  -tcp_rmem_min 4096 \
  -tcp_adv_win_scale 2 \
  -tcp_wmem_min 4096 \
  -tcp_port_min 1024 \
  -tcp_stdurg false \
  -tcp_port_max 65535 \
  -tcp_fin_timeout 60 \
  -tcp_no_metrics_save false \
  -tcp_dsack true \
  -tcp_mem_high 49152 \
  -tcp_frto 0 \
  -tcp_app_win 31 \
  -ip_no_pmtu_disc false \
  -tcp_window_scaling false \

```

```
set Settings [::IxLoad new ixNetIxLoadSettingsPlugin]
# ixNet objects needs to be added in the list
# before they are configured!
$Network1 globalPlugins.appendItem -object $Settings

$Settings config \
    -teardownInterfaceWithUser      false \
    -name                            "Settings" \
    -interfaceBehavior              0

set Ethernet_1 [$Network1 getL1Plugin]

set my_ixNetEthernetELMPlugin [::IxLoad new ixNetEthernetELMPlugin]
$my_ixNetEthernetELMPlugin config \
    -negotiationType                "master" \
    -negotiateMasterSlave           true

$Ethernet_1 config \
    -advertise10Full                true \
    -name                            "Ethernet-1" \
    -autoNegotiate                  true \
    -advertise100Half               true \
    -advertise10Half                true \
    -speed                          "k100FD" \
    -advertise1000Full              true \
    -advertise100Full               true \
    -cardElm

$my_ixNetEthernetELMPlugin
$Ethernet_1 childrenList.clear
```

Configure the Dynamic  
Control plane settings.

Configure the physical  
layer properties.

```
set MAC_VLAN_9 [::IxLoad new ixNetL2EthernetPlugin]
# ixNet objects needs to be added in the list
# before they are configured!
$Ethernet_1 childrenList.appendItem -object $MAC_VLAN_9

$MAC_VLAN_9 config \
    -name "MAC/VLAN-9"

$MAC_VLAN_9 childrenList.clear

set IP_4 [::IxLoad new ixNetIpV4V6Plugin]
# ixNet objects needs to be added in the list
# before they are configured!
$MAC_VLAN_9 childrenList.appendItem -object $IP_4

$IP_4 config \
    -name "IP-4"

$IP_4 childrenList.clear

set L2TP_1 [::IxLoad new ixNetL2tpPlugin]
# ixNet objects needs to be added in the list
# before they are configured!
$IP_4 childrenList.appendItem -object $L2TP_1

$L2TP_1 config \
    -name "L2TP-1"

$L2TP_1 childrenList.clear
$L2TP_1 extensionList.clear

$IP_4 extensionList.clear

$MAC_VLAN_9 extensionList.clear

$Ethernet_1 extensionList.clear
```

Configure the MAC addresses and VLAN tags.

Configure an IP address range.

Configure an L2TP plugin and append it to the IP range.

Name the L2TP plugin.

Clear the lists of extension protocols.

```
#####
# Setting the ranges starting with the plugin on top of the stack
#####
$L2TP_1 l2tpRanges.clear

set L2TP_R1 [::IxLoad new ixNetL2tpRange]
# ixNet objects needs to be added in the list
# before they are configured!
$L2TP_1 l2tpRanges.appendItem -object $L2TP_R1

$L2TP_R1 config \
  -authTimeout 10 \
  -lacToLNSMapping "gateway" \
  -authRetries 20 \
  -authType "none" \
  -sessionsPerTunnel 1 \
  -echoReqInterval 10 \
  -domainList "Domain Groups" \
  -peerHostName "ixia" \
  -useHiddenAVPs false \
  -incrementBy 1 \
  -ncpRetries 3 \
  -serverPrimaryDnsAddress "10.10.10.10" \
  -clientDnsOptions "disableExtension" \
  -enableHelloRequest false \
  -lcpTermTimeout 15 \
  -baseLnsIp "0.0.0.0" \
  -name "L2TP-R1" \
  -lcpTermRetries 3 \
  -serverIIDIncr 1 \
  -rxConnectSpeed 268435456 \
  -clientBaseIID "00:11:11:11:00:00:00:01" \
  -numSessions 1 \
  -tunnelAuthentication "none" \
  -serverBaseIID "00:11:22:11:00:00:00:01" \
  -ncpTimeout 10 \
  -tunnelDestinationIp "10.10.10.1" \
  -ipv6PoolPrefixLen 48 \
  -l2tpAuthOptions "L2TP Authentication Options" \
  -clientIIDIncr 1 \
  -udpDestinationPort 1701 \
```

Configure the address ranges for the L2TP plugin.

Configure the L2TP plugin.

```

set IP_R4 [{$L2TP_R1 getLowerRelatedRange "IpV4V6Range"}

$IP_R4 config \
    -count 1 \
    -name "IP-R4" \
    -gatewayAddress "0.0.0.0" \
    -enabled true \
    -autoMacGeneration true \
    -mss 1460 \
    -incrementBy "0.0.0.1" \
    -prefix 16 \
    -gatewayIncrement "0.0.0.0" \
    -gatewayIncrementMode "perSubnet" \
    -generateStatistics false \
    -ipAddress "10.10.0.5" \
    -ipType "IPv4"

set MAC_R8 [{$IP_R4 getLowerRelatedRange "MacRange"}

$MAC_R8 config \
    -count 1 \
    -name "MAC-R8" \
    -enabled true \
    -mtu 1500 \
    -mac "00:0A:0A:00:05:00" \
    -incrementBy "00:00:00:00:00:01"

set VLAN_R1 [{$IP_R4 getLowerRelatedRange "VlanIdRange"}

$VLAN_R1 config \
    -incrementStep 1 \
    -uniqueCount 4094 \
    -name "VLAN-R1" \
    -innerIncrement 1 \
    -innerUniqueCount 4094 \
    -enabled true \
    -innerFirstId 1 \
    -increment 1 \
    -priority 1 \
    -firstId 1 \
    -innerIncrementStep 1 \
    -idIncrMode 2 \
    -innerEnable false \
    -innerPriority 1

```

Configure an IP range for the L2TP plugin.

Configure the MAC addresses for the IP range.

Configure the VLAN tags for the IP range.

---

# GTPSPlugin

## SYNOPSIS

## DESCRIPTION

Configures a GTP SGSN plugin.

## SUBCOMMANDS

## OPTIONS

`name`

Name of the instance of the plugin.

Default value = "None"

`childrenList`

Name of the list of next-lower layer plugins.

Default value = "None"

`extensionList`

Name of the list of protocol extensions.

Default value = "None"

`sgsnRangeList`

List of emulated SGSNs. This must be a `GTPSRange` object.

Default value = "None"

`ueRangeList`

List of emulated UEs. This must be a `GTPSUERange` object.

Default value = "None"

`ixGTPVersion`

GTP version.

Default value = "3.20.1.51"

## EXAMPLE

```
set GTP_1 [::IxLoad new ixNetGTPSPlugin]
# ixNet objects needs to be added in the list before they are configured!
$MAC_VLAN_5 childrenList.appendItem -object $GTP_1

$GTP_1 config \
-ixGTPVersion          "3.20.1.79" \
-name                  "GTP-1"

$GTP_1 childrenList.clear

$GTP_1 extensionList.clear

$MAC_VLAN_5 extensionList.clear

$Ethernet_1 extensionList.clear
```

## SEE ALSO

### GTP SGSN Plugin

This section describes the GTP SGSN plugin.

### GTP GGSN Plugin

This section describes the GTP GGSN plugin.



## **eGTP Plugin**

This section describes the eGTP plugin.

### **eGTP Plugin MME eNB S1 S11 commands**

This section describes the eGTP MME eNodeB S1 S11 settings.

### **eGTP Plugin Network Commands**

This section describes the eGTP network commands.

### **eGTP eGTP PGW S5 S8 commands**

This section describes the eGTP PGW S5 S8 commands.

### **eGTP eGTP SGSN RNC S4 commands**

This section describes the eGTP SGSN RNC S4 commands.

### **eGTP SGW S1 S11 commands**

This section describes the eGTP SGW S1 S11 commands.

### **eGTP Plugin DNS commands**

This section describes the eGTP plugin DNS settings.

### **eGTP Base objects**

This section describes the eGTP base (common) objects.

## DSLite Plugin

This section describes the DSLite plugin.

### DSLite Range

#### SYNOPSIS

#### DESCRIPTION

Creates a DSLite range.

#### SUBCOMMANDS

#### OPTIONS

`startAddress`

The IPv4 Address for the first emulated host in this range of addresses.

The default value is 192.168.0.1.

`incrementBy`

The step value for incrementing the host IP addresses in the range.

The default value is 0.0.0.1.

`sameHostsPerTunnel`

You use this option to specify whether or not the host IPv4 addresses will be duplicated on each emulated home gateway.

#### **If enabled:**

If this option is enabled, the same set of IPv4 addresses will be configured behind each tunnel.

For example:

- *Same Hosts Per Tunnel* is enabled.
- *Host Start Address* = 192.168.0.1.
- *Address Increment* = 0.0.0.1.
- *B4 Count* = 2.
- *Hosts per B4* = 2.

As a result, each B4 (home gateway) will have have the following hosts behind it: 192,168.0.1, 192.168.0.2.

**If disabled:**

If this option is not enabled, IxLoad will configure a set of unique IPv4 addresses across the home gateways. In this case, the test configuration will not contain any duplicate IPv4 addresses.

For example:

- *Same Hosts Per Tunnel* is disabled.
- *Host Start Address* =192.168.0.1.
- *Address Increment* = 0.0.0.1.
- *B4 Count* = 2.
- *Hosts per B4* = 2.

As a result, the first B4 will be configured with hosts 192.168.0.1 and 192.168.0.2, and the second B4 will be configured with hosts 192.168.0.3 and 192.168.0.4.

API values = true (default), false

tunnelDst

The address of the tunnel destination (the AFTR address).

Set this parameter to match the address of the interface on the DUT being used in the test.

The default value is ::c612:65.

ipType

A read-only value that shows the IP version used for the emulated hosts (behind the home gateway).

The only valid value is IPv4.

tunnelCount

A read-only value that shows the number of emulated B4 elements configured on the IP stack element.

API Default = 1

enabled

If enabled, the DSLite address range is enabled for use in the configuration.

If disabled, the range will not be validated, nor will it be configured.

Each DSLite address range is enabled by default.

API default = true

hostCount

A read-only value that shows the total number of emulated hosts that will be carried by the tunnel configured for this range.

The value is calculated as the number of hosts that you specify (*Hosts Per B4*) multiplied by the number of B4 elements configured on the IP stack element (shown in the *B4 Count* parameter).

API default = 10

`mss`

The Maximum Segment Size. The MSS is the largest amount of data, specified in bytes, that the IP device can transmit as a single, unfragmented unit.

The TCP MSS equals the MTU minus the TCP header size minus the IP header size.

IxLoad supports jumbo frames. Therefore the maximum value is 9460 (9500 minus 40).

The default value is 1440.

API default = 1440

`tunnelDstIncrementBy`

Amount to increment the AFTR address (`tunnelDst` parameter).

API default = ":::0"

`useGatewayAsTunnelDst`

If enabled, the IPv6 gateway address is used as the tunnel destination (the AFTR address, configured in the `tunnelDst` parameter).

API default = false

`hostsPerTunnel`

The number of desired emulated hosts for this range.

The default value is 10.

API default = 10

### EXAMPLE

### SEE ALSO

## Global Services Plugins

This section describes the global plugins.

---

## Filter Plugin

### SYNOPSIS

### DESCRIPTION

Configures a filter to filter traffic on an Ixia port. Filters are applied on all ports in the network group.

### SUBCOMMANDS

#### OPTIONS

name

Name of the instance of the plugin.

Default value = "None"

auto

If `true`, filters will be configured automatically to allow traffic for protocols defined in the current stack.

Default value = "True"

all

If `true`, all traffic is allowed through; no traffic is filtered out.

Default value = "False"

isis

If `true`, ISIS traffic is allowed to pass through.

Default value = "False"

ip

A list of IP protocol names or numbers to enable. Numbers are expressed in decimal or `0x<hex digits>` format. Ranges may be separated by a dash ( - ). A blank entry signifies no IP protocol filtering.

Default value = "" (null)

tcp

A list of TCP source or destination well-known port names or port numbers to enable. Ranges may be separated by a dash ( - ). A blank entry signifies no UDP port filtering.

Default value = "" (null)

udp

A list of UDP source or destination well-known port names or port numbers to enable. Ranges may be separated by a dash ( - ). A blank entry signifies no UDP port filtering.

Default value = "" (null)

mac

A list of MAC type names or numbers to enable. Numbers are expressed in decimal or 0x<hex digits> format. Ranges may be separated by a dash ( - ). A blank entry signifies no MAC type filtering.

Default value = "" (null)

icmp

A list of ICMP type names or numbers to enable. Numbers are expressed in decimal or 0x<hex digits> format. Ranges may be separated by a dash ( - ). A blank entry signifies no ICMP type filtering.

Default value = "" (null)

### EXAMPLE

```
set Filter [::IxLoad new ixNetFilterPlugin]# ixNet objects needs to be added in the list before they are configured!$Network1 globalPlugins.appendItem -object $Filter
```

```
$Filter config \-all                                false \-isis
false \-name                                         "Filter" \-auto
true \-udp                                           "" \-tcp
"" \-mac                                             "" \-ip
"" \-icmp                                           ""
```

### SEE ALSO

## Gratuitous ARP Plugin

### SYNOPSIS

### DESCRIPTION

Enables the Grat ARP plugin.

The *Grat ARP* global service allows you to configure a test to broadcast a gratuitous ARP request packet to all connected interfaces before starting the test. In this way, the emulated network nodes advertise their own addresses, ensuring that the DUT has valid ARP cache entries.

In a gratuitous ARP packet, the ARP Sender Protocol Address and ARP Target Protocol Address are both set to the IP address of the source host, and the ARP Sender Hardware Address is set to the link-layer address of the source host.

## SUBCOMMANDS

### OPTIONS

name

Name of the instance of the plugin.

Default value = "None"

enabled

If `true`, the Grat ARP service is enabled.

Default value = "True"

### EXAMPLE

```
set GratARP [::IxLoad new ixNetGratArpPlugin]
# ixNet objects needs to be added in the list before they are configured!
$Network1 globalPlugins.appendItem -object $GratARP

$GratARP config \
-enabled                true \
-name                  "GratARP"
```

### SEE ALSO

## DNS Plugin

## SYNOPSIS

## DESCRIPTION

Configures the DNS global servers.

## SUBCOMMANDS

## OPTIONS

`name`

Name of the instance of the plugin.

Default value = "None"

`domain`

The DNS domain for the host.

Default value = "" (null)

`timeout`

The amount of time an entry should remain in cache memory before being flushed.

Default value = "5"

`nameServerList`

Name of the list of DNS servers to be used.

Default value = "None"

`searchList`

Name of the list of DNS servers to be searched.

Default value = "None"

`hostList`

Name of the list of DNS hosts to be used.

Default value = "None"

## EXAMPLE

```
set DNS [::IxLoad new ixNetDnsPlugin]
```

```
# ixNet objects needs to be added in the list before they are configured!
```



---

```
$Network1 globalPlugins.appendItem -object $DNS

$DNS config \
-domain            "ixiacom.com" \
-name             "DNS" \
-timeout          5

$DNS hostList.clear

set my_ixNetDnsHost [::IxLoad new ixNetDnsHost]
# ixNet objects needs to be added in the list before they are configured!
$DNS hostList.appendItem -object $my_ixNetDnsHost

$my_ixNetDnsHost config \
-alias2           "localhost-alias2" \
-hostName         "localhost" \
-alias1           "localhost-alias1" \
-hostIP           "127.0.0.1"

$DNS searchList.clear

set my_ixNetDnsSearch [::IxLoad new ixNetDnsSearch]
# ixNet objects needs to be added in the list before they are configured!
$DNS searchList.appendItem -object $my_ixNetDnsSearch

$my_ixNetDnsSearch config \
-search           ".com"

$DNS nameServerList.clear
```

```
set my_ixNetDnsNameServer [::IxLoad new ixNetDnsNameServer]
# ixNet objects needs to be added in the list before they are configured!
$DNS nameServerList.appendItem -object $my_ixNetDnsNameServer

$my_ixNetDnsNameServer config \
-nameServer          "127.0.0.1"
```

## SEE ALSO

## TCP Plugin

### SYNOPSIS

### DESCRIPTION

Configures the global settings for a TCP plugin.

### SUBCOMMANDS

### OPTIONS

name

Name of the instance of the plugin.

Default value = "None"

tcp\_abort\_on\_overflow

Reserved.

Default value = "False"

tcp\_adv\_win\_scale

Reserved.

Default value = "2"

---

### adjust\_tcp\_buffers

If set to `true`, for certain test configurations, the values configured for the TCP read and write buffer sizes are ignored and values selected by IxLoad are used instead. If set to `false`, buffer size adjustment is disabled and the configured values for the TCP read and write buffer sizes are used.

Default value = "true"

tcp\_app\_win

Reserved.

Default value = "31"

tcp\_bic

Reserved.

Default value = "0"

tcp\_bic\_fast\_convergence

Reserved.

Default value = "1"

tcp\_bic\_low\_window

Default value = "14"

tcp\_dsack

Reserved.

Default value = "True"

tcp\_ecn

If `true`, Explicit Congestion Notification is enabled.

Default value = "False"

tcp\_fack

Reserved.

Default value = "True"

tcp\_fin\_timeout

FIN Timeout. The number of seconds the client or server waits to receive a final FIN before closing a socket. A FIN Timeout is usually used to prevent denial-of-service attacks.

Default value = "60"

tcp\_frto

Fragment Reassembly Timer. ReThe number of seconds the TCP should keep IP fragments before discarding them.

Default value = "0"

`tcp_keepalive_intvl`

The number of seconds between repeated keep-alive probes.

Default value = "75"

`tcp_keepalive_probes`

Number of keep-alive probes sent out before determining that a link is down.

Default value = "9"

`tcp_keepalive_time`

If a link has no activity on it for the time specified, keep-alive probes are sent to determine if the link is still up. The Keep-alive Time value is expressed in seconds.

Default value = "7200"

`tcp_low_latency`

Reserved.

Default value = "0"

`tcp_max_orphans`

Reserved.

Default value = "8192"

`tcp_max_syn_backlog`

Reserved.

Default value = "1024"

`tcp_max_tw_buckets`

Reserved.

Default value = "180000"

`tcp_mem_low`

Reserved.

Default value = "24576"

`tcp_mem_pressure`

Reserved.

---

Default value = "32768"

tcp\_mem\_high

Reserved.

Default value = "49152"

tcp\_moderate\_rcvbuf

Reserved.

Default value = "0"

tcp\_no\_metrics\_save

Reserved.

Default value = "False"

tcp\_orphan\_retries

Reserved.

Default value = "0"

tcp\_reordering

Reserved.

Default value = "3"

tcp\_retrans\_collapse

Default value = "True"

tcp\_retries1

Retransmit Retries 1. The number of times TCP will attempt to retransmit a segment on an established connection. If the number of retransmit attempts exceeds this value, TCP requests that the network layer update the route. The default is the RFC 1122 specified minimum of 3 retransmissions.

Default value = "3"

tcp\_retries2

Retransmit Retries 2. If the number of retransmissions of the same segment reaches this threshold, TCP closes the connection. The default value is 15, which corresponds to a duration of approximately between 13 to 30 minutes, depending on the retransmission timeout.

Default value = "15"

tcp\_rfc1337

Reserved.

Default value = "False"

tcp\_rmem\_min

Reserved.

Default value = "4096"

tcp\_rmem\_default

Reserved.

Default value = "262144"

tcp\_rmem\_max

Reserved.

Default value = "262144"

tcp\_sack

If `true`, RFC 2018 TCP Selective Acknowledgements are enabled.

Default value = "True"

tcp\_stdurg

Reserved.

Default value = "False"

tcp\_synack\_retries

Number of times an un-acknowledged SYN-ACK for a passive TCP connection will be re-transmitted.

Default value = "5"

tcp\_syn\_retries

Number of times an un-acknowledged SYN for an active TCP connection will be re-transmitted.

Default value = "5"

tcp\_timestamps

If `true`, the client or server inserts a timestamp into each packet.

**Note:** Enabling the TCP Timestamp option adds 12 bytes to the TCP header. This has the effect of reducing the effective MSS configured.

Default value = "True"

tcp\_tw\_recycle

If `true`, fast recycling of TIME-WAIT sockets is enabled. Enabling this option is not recommended when working with NAT (Network Address Translation).

Default value = "False"

---

tcp\_tw\_reuse

If `true`, allows the reuse of TIME-WAIT sockets for new connections. Enable this option only if you are certain that it is safe from a protocol viewpoint.

Default value = "False"

tcp\_vegas\_alpha

Reserved.

Default value = "2"

tcp\_vegas\_beta

Reserved.

Default value = "6"

tcp\_vegas\_cong\_avoid

Reserved.

Default value = "0"

tcp\_vegas\_gamma

Reserved.

Default value = "2"

tcp\_westwood

Reserved.

Default value = "0"

tcp\_window\_scaling

If `true`, RFC 1323 TCP window scaling is enabled. The TCP Window Scaling feature allows the use of a large window (greater than 64K) on a TCP connection, if the other end supports it.

Default value = "True"

ip\_no\_pmtu\_disc

Reserved.

Default value = "False"

tcp\_wmem\_min

Reserved.

Default value = "4096"

tcp\_wmem\_default

Reserved.

Default value = "262144"

tcp\_wmem\_max

Reserved.

Default value = "262144"

tcp\_ipfrag\_time

Fragment Reassembly Timer. The number of seconds the TCP should keep IP fragments before discarding them.

Default value = "30"

tcp\_port\_min

Minimum TCP source port value. The source port specifies which ports to use for client connections. The Min value specifies the lower bound (the lowest permissible port number).

Default value = "1024"

tcp\_port\_max

Maximum TCP source port value. The Maximum source port value specifies the upper bound (the highest permissible port number).

Default value = "65535"

tcp\_rto\_min

Minimum Retransmission Timeout value.

Default value = "200"

tcp\_rto\_max

Maximum Retransmission Timeout value.

Default value = "120000"

llm\_hdr\_gap

The number of bytes separating packets in a stream.

The default value is 8, the minimum is 8, and the maximum is 8191.

tcp\_reordering

The number of duplicate ACKs that are required to indicate that a packet was lost.

Changing this value is not recommended.

The default is 3, the minimum is 0, and the maximum is 255.

tcp\_max\_tw\_buckets



The maximum number of sockets that can be in the TIME\_WAIT state in the system.

The purpose of this limit is to prevent simple DoS attacks. If this number is exceeded, the socket is closed and a warning is displayed.

The default is 180,000 and the minimum is 0.

`tcp_tw_rfc1323_strict`

Enables RFC 1323 strict behavior. Specifically, if a packet has TSOPT set, but does not have the ACK bit set, the TSecr field in the TSOPT will be zero in that packet.

API Values = true, false (default)

`udp_port_randomization`

Enables UDP port randomization.

If this option is set, each new sockets will be bound to a random port.

API Values = true, false (default)

### EXAMPLE

```
set TCP [::IxLoad new ixNetTCPPlugin]# ixNet objects needs to be added in the list
before they are configured!$Network1 globalPlugins.appendItem -object $TCP
```

```
$TCP config \-tcp_bic 0 \-tcp_tw_recycle
true \-tcp_retries2 5 \-tcp_retries1
3 \-tcp_keepalive_time 75 \-tcp_moderate_rcvbuf
0 \-tcp_rfc1337 false \-tcp_ipfrag_time
30 \-tcp_rto_max 60000 \-tcp_vegas_alpha
2 \-tcp_ecn false \-tcp_westwood
0 \-tcp_rto_min 1000 \-tcp_reordering
3 \-tcp_vegas_cong_avoid 0 \-tcp_keepalive_intvl
7200 \-tcp_rmem_max 262144 \-tcp_orphan_retries
0 \-tcp_max_tw_buckets 180000 \-tcp_wmem_default
4096 \-tcp_low_latency 0 \-tcp_rmem_min
4096 \-tcp_adv_win_scale 2 \-tcp_wmem_min
4096 \-tcp_port_min 1024 \-tcp_stdurg
false \-tcp_port_max 65535 \-tcp_fin_timeout
60 \-tcp_no_metrics_save false \-tcp_dsack
true \-tcp_mem_high 49152 \-tcp_frto
0 \-tcp_app_win 31 \-ip_no_pmtu_disc
false \-tcp_window_scaling false \-tcp_max_orphans
8192 \-tcp_mem_pressure 32768 \-tcp_syn_retries
5 \-name "TCP" \-tcp_max_syn_backlog
1024 \-tcp_mem_low 24576 \-tcp_fack
true \-tcp_retrans_collapse true \-tcp_rmem_default
4096 \-tcp_keepalive_probes 9 \-tcp_abort_on_overflow
false \-tcp_tw_reuse false \-tcp_wmem_max
```

```
262144 \-tcp_vegas_gamma          2 \-tcp_synack_retries
5 \-tcp_timestamps              true \-tcp_vegas_beta
6 \-tcp_sack                     true \-tcp_bic_fast_convergence
1 \-tcp_bic_low_window           14
```

## SEE ALSO

## Routes Plugin

### SYNOPSIS

### DESCRIPTION

Configures *Routes* global service, which allows the network group to be associated with a set of IP routes.

### SUBCOMMANDS

### OPTIONS

name

Name of the instance of the plugin.

Default value = "None"

routes

List of routes. This list must be a `RouteList` object.

Default value = "None"

### EXAMPLE

```
set Routes_1 [::IxLoad new ixNetRoutesPlugin]
# ixNet objects needs to be added in the list before they are configured!
$Network1 globalPlugins.appendItem -object $Routes_1
```

```
$Routes_1 config \  
-name                "Routes-1"
```

```
$Routes_1 routes.clear
```

## SEE ALSO

# Dynamic Control Plane plugin

## SYNOPSIS

## DESCRIPTION

Configures the IxLoad Dynamic Control Plane settings.

## SUBCOMMANDS

## OPTIONS

`name`

Name of the instance of the plugin.

Default value = "None"

`teardownInterfaceWithUser`

If `true`, the interfaces will come up with the users and will go down when users go down.

This option is enabled only if the `interfaceBehavior` is `true`.

Default value = "False"

`interfaceBehavior`

If `true`, enables dynamic control plane. The interfaces are created on demand but are not destroyed until the test ends.

Default value = "0"

## EXAMPLE

```
set Settings [::IxLoad new ixNetIxLoadSettingsPlugin]
```

```
# ixNet objects needs to be added in the list before they are configured!  
$Network1 globalPlugins.appendItem -object $Settings
```

```
$Settings config \  
-teardownInterfaceWithUser      true \  
-name                            "Settings" \  
-interfaceBehavior              1
```

### **SEE ALSO**

## **Mobile Subscribers Plugins**

This section describes the Mobile Subscriber plugin.

## **MobileSubscribersPlugin**

### **SYNOPSIS**

### **DESCRIPTION**

Creates a network stack element representing 3G mobile subscribers.

### **SUBCOMMANDS**

### **OPTIONS**

`name`

Name of the instance of the plugin.

Default value = "None"

`childrenList`

Name of the list of next-lower layer plugins.

Default value = "None"

extensionList

Name of the list of protocol extensions.

Default value = "None"

rangeList

List of MobileSubscriber ranges. New elements can be added to the using appendItem. The elements of the list can be modified, but the list cannot be replaced.

Default value="None".

### **EXAMPLE**

```
set Mobile_Subscribers_1 [::IxLoad new ixNetMobileSubscribersPlugin]
# ixNet objects needs to be added in the list before they are configured!
$Emulated_Router_1 childrenList.appendItem -object $Mobile_Subscribers_1

$Mobile_Subscribers_1 childrenList.clear

$Mobile_Subscribers_1 extensionList.clear
```

### **SEE ALSO**

## **Radius Plugin**

### **SYNOPSIS**

### **DESCRIPTION**

Defines a Radius plugin. A Radius plugin is an extension to a Mobile Subscribers plugin.

### **SUBCOMMANDS**

## OPTIONS

name

Name of the instance of the plugin.

Default value = "None"

rangeList

List or Radius ranges.

Default value = "None"

## EXAMPLE

```
set RADIUS_1 [::IxLoad new ixNetRadiusPlugin]
# ixNet objects needs to be added in the list before they are configured!
$Mobile_Subscribers_1 extensionList.appendItem -object $RADIUS_1

$Emulated_Router_1 extensionList.clear

$MAC_VLAN_2 extensionList.clear

$Ethernet_1 extensionList.clear

$MAC_VLAN_11 extensionList.clear

$Ethernet_1 extensionList.clear

#####
# Setting the ranges starting with the plugin on top of the stack
#####
$Mobile_Subscribers_1 rangeList.clear
```

## SEE ALSO

## Mobile Subscribers Example

This section shows an example of how to create a Mobile Subscribers plugin in the Tcl API.

```
#####
# IxLoad ScriptGen created TCL script
# Network1 serialized using version 4.30.0.131
# 3GPP_radius_mobile_subs.tcl made on Aug 17 2009 13:33
#####

set Network1 [::IxLoad new ixNetworkGroup $chassisChain]
$Network1 config \
    -comment          "" \
    -name              "Network1" \
    -macMappingMode   0 \
    -linkLayerOptions 0

$Network1 globalPlugins.clear
$Network1 globalPlugins.appendItem -object $Filter_1

set Filter_1 [::IxLoad new ixNetFilterPlugin]
# ixNet objects needs to be added in the list before they are
# configured!
$Filter_1 config \
    -all                false \
    -pppoecontrol       false \
    -isis                false \
    -auto                true \
    -udp                 "" \
    -tcp                 "" \
    -mac                 "" \
    -pppoenetwork       false \
    -ip                  "" \
    -icmp                ""

set GratarP_1 [::IxLoad new ixNetGratArpPlugin]
# ixNet objects needs to be added in the list before they are
# configured!
$GratarP_1 config \
    -forwardGratArp    false \
    -enabled            true
```

Annotations in the original image:

- Blue box: "Create a network group." (points to `-name "Network1"`)
- Blue box: "Clear the global plugins list." (points to `$Network1 globalPlugins.clear`)
- Blue box: "Begin appending items to global plugin list." (points to `$Network1 globalPlugins.appendItem`)
- Blue box: "Optionally, create a filter to filter traffic." (points to `$Filter_1 config`)
- Blue box: "Optionally, enable Gratuitous ARP." (points to `-enabled true`)

```
set TCP_1 [::IxLoad new ixNetTCPPlugin]
# ixNet objects needs to be added in the list before they
are configured!
$Network1 globalPlugins.appendItem -object $TCP_1
$TCP_1 config \
    -tcp_bic 0 \
    -tcp_tw_recycle true \
    -tcp_retries2 5 \
    -disable_min_max_buffer_size false \
    -tcp_retries1 3 \
    -tcp_keepalive_time 7200 \
    -tcp_rfc1337 false \
    -tcp_ipfrag_time 30 \
    -tcp_rto_max 60000 \
    -tcp_vegas_alpha 2 \
    -tcp_ecn false \
    -tcp_westwood 0 \
    -tcp_rto_min 1000 \
    -tcp_reordering 3 \
    -tcp_vegas_cong_avoid 0 \
    -tcp_keepalive_intvl 75 \
    -tcp_rmem_max 262144 \
    -tcp_orphan_retries 0 \
    -tcp_max_tw_buckets 180000 \
    -tcp_wmem_default 4096 \
    -tcp_low_latency 0 \
    -tcp_rmem_min 4096 \
    -tcp_adv_win_scale 2 \
    -tcp_wmem_min 4096 \
    -tcp_port_min 1024 \
    -tcp_stdurg false \
    -tcp_port_max 65535 \
    -tcp_fin_timeout 60 \
    -tcp_no_metrics_save false \
    -tcp_dsack true \
    -tcp_mem_high 49152 \
    -tcp_frto 0 \
    -tcp_app_win 31 \
    -tcp_vegas_beta 6 \
    -tcp_window_scaling false \
    -tcp_max_orphans 8192 \
    -tcp_mem_pressure 32768 \
    -tcp_syn_retries 5 \
```

Configure the TCP  
portion of the stack.



```

set DNS_1 [::IxLoad new ixNetDnsPlugin]
# ixNet objects needs to be added in the list before they are
configured!
$Network1 globalPlugins.appendItem -object $DNS_1

$DNS_1 config \
    -domain          "" \
    -timeout         30

$DNS_1 hostList.clear

$DNS_1 searchList.clear

$DNS_1 nameServerList.clear

set Settings_1 [::IxLoad new ixNetIxLoadSettingsPlugin]
# ixNet objects needs to be added in the list before they are
configured!
$Network1 globalPlugins.appendItem -object $Settings_1

$Settings_1 config \
    -teardownInterfaceWithUser    false \
    -interfaceBehavior            0

set Ethernet_1 [$Network1 getL1Plugin]

set my_ixNetEthernetELMPlugin [::IxLoad new
ixNetEthernetELMPlugin]
$my_ixNetEthernetELMPlugin config \
    -negotiationType          "master" \
    -negotiateMasterSlave    true

set my_ixNetDualPhyPlugin [::IxLoad new ixNetDualPhyPlugin]
$my_ixNetDualPhyPlugin config \
    -medium

```

Optionally, configure the DNS settings.

Configure the Dynamic Control plane settings.

Configure the physical layer properties.

```
$Ethernet_1 config \  
-advertise10Full true \  
-directedAddress "01:80:C2:00:00:01" \  
-autoNegotiate Configure the Ethernet true \  
-advertise100Half parameters. true \  
-advertise10Half true \  
-enableFlowControl false \  
-speed "k100FD" \  
-advertise1000Full true \  
-advertise100Full true \  
-cardElm $my_ixNetEthernetELMPlugin \  
-cardDualPhy $my_ixNetDualPhyPlugin  
  
$Ethernet_1 childrenList.clear Configure the MAC  
addresses and VLAN tags.  
  
set MAC_VLAN_2 [::IxLoad new ixNetL2EthernetPlugin]  
# ixNet objects needs to be added in the list before they are  
configured!  
$Ethernet_1 childrenList.appendItem -object $MAC_VLAN_2  
  
$MAC_VLAN_2 childrenList.clear Configure the  
Emulated Router.  
  
set Emulated_Router_1 [::IxLoad new ixNetEmulatedRouterPlugin]  
# ixNet objects needs to be added in the list before they are  
configured!  
$MAC_VLAN_2 childrenList.appendItem -object $Emulated_Router_1  
  
$Emulated_Router_1 childrenList.clear
```

```
set Mobile_Subscribers_1 [::IxLoad new
ixNetMobileSubscribersPlugin]
# ixNet objects needs to be added in the list before they are
configured!
$Emulated_Router_1 childrenList.appendItem -object
$Mobile_Subscribers_1

$Mobile_Subscribers_1 childrenList.clear

$Mobile_Subscribers_1 extensionList.clear

set RADIUS_1 [::IxLoad new ixNetRadiusPlugin]
# ixNet objects needs to be added in the list before they are
configured!
$Mobile_Subscribers_1 extensionList.appendItem -object $RADIUS_1

$Emulated_Router_1 extensionList.clear

$MAC_VLAN_2 extensionList.clear

$Ethernet_1 extensionList.clear
```

Configure a Mobile  
Subscribers plugin.

Configure a Radius plugin .

Clear the extension lists.

```
#####
# Setting the ranges starting with the plugin on top of the stack
#####
$Mobile_Subscribers_1 rangeList.clear
set Subscriber_R1 [::IxLoad new ixNetMobileSubscribersRange]
# ixNet objects needs to be added in the list before they are
configured!
$Mobile_Subscribers_1 rangeList.appendItem -object $Subscriber_R1

$Subscriber_R1 config \
    -reliabilityClass          2 \
    -interimUpdateInterval    1 \
    -sduErrorRatio            6 \
    -publishStats             false \
    -guaranteedBitRateUL      64 \
    -authType                 "PAP" \
    -maxSDUSize               151 \
    -guaranteedBitRateDL      64 \
    -signalingIndication      0 \
    -imsiMSIN                 1000000001 \
    -iMEI                    "9999000000000001" \
    -imsiMCC                  226 \
    -trafficHandlingPriority   1 \
    -deliveryOrder            2 \
    -delayClass               0 \
    -papPassword              "password" \
    -chapName                 "user" \
    -meanThroughput           31 \
    -peakThroughput           6 \
    -subscriberIncrement      1 \
    -precedenceClass          2 \
    -maxBitRateDL             8640 \
    -papUser                  "user" \
    -subscriberCount          1 \
    -ipType                   "IPv4" \
    . . .
    -residualBER              7

set RADIUS_R1 [$Subscriber_R1 getExtensionRange $RADIUS_1]
```

Configure an address range for the Mobile Subscribers plugin.

```

set DefaultTunnelAttributes [::IxLoad new ixNetRadiusOptionSet]
$DefaultTunnelAttributes config \
  -defaultp true \
  -name "DefaultTunnelAttributes" \
  -ipType "IPv4"
$DefaultTunnelAttributes messages.clear

```

Configure the tunnel attributes option set.

```

set AccessRequest [::IxLoad new ixNetRadiusMessage]
# ixNet objects needs to be added in the list before they are
configured!
$DefaultTunnelAttributes messages.appendItem -object
$AccessRequest
$AccessRequest config \
  -name "AccessRequest" \
  -defaultp true \
  -messageType "ACCESS_REQUEST" \
  -ipType "IPv4"
$AccessRequest optionTlvs.clear

```

Configure a Radius message for the option set.

Configure a TLV for the message.

```

set 3GPP_IMSI [::IxLoad new ixNetRadiusOptionTLV]
# ixNet objects needs to be added in the list before they are
configured!
$AccessRequest optionTlvs.appendItem -object $3GPP_IMSI
$3GPP_IMSI config \
  -rfc true \
  -code "26/10415/1" \
  -type 10 \
  -name "3GPP-IMSI" \
  -value "AUTO"

```

```
$RADIUS_R1 config \  
  -retries 3 \  
  -accountingServer "1.1.1.1" \  
  -enabled true \  
  -secret "secret" \  
  -accountingPort 1813 \  
  -enableAccounting true \  
  -timeout 10 \  
  -authenticationPort 1812 \  
  -authenticationServer "1.1.1.1" \  
  -tunnelAttributeSet $DefaultTunnelAttributes  
  
$Emulated_Router_1 rangeList.clear  
  
set ER_R1 [::IxLoad new ixNetEmulatedRouterRange]  
# ixNet objects needs to be added in the list before they are  
configured!  
$Emulated_Router_1 rangeList.appendItem -object $ER_R1  
  
$ER_R1 config \  
  -count 100 \  
  -enableGatewayArp false \  
  -generateStatistics false \  
  -autoCountEnabled false \  
  -enabled true \  
  -autoMacGeneration true \  
  -incrementBy "0.0.0.1" \  
  -prefix 16 \  
  -gatewayIncrement "0.0.0.0" \  
  -gatewayIncrementMode "perSubnet" \  
  -mss 1460 \  
  -gatewayAddress "0.0.0.0" \  
  -ipAddress "10.10.0.101" \  
  -ipType "IPv4"
```

Configure the Radius range properties.

Add the range list to the emulated router.

```
set MAC_R2 [{$ER_R1 getLowerRelatedRange "MacRange"}]

$MAC_R2 config \
  -count 100 \
  -mac "00:0A:0A:00:65:00" \
  -mtu 1500 \
  -enabled true \
  -incrementBy "00:00:00:00:00:01"

set VLAN_R2 [{$ER_R1 getLowerRelatedRange "VlanIdRange"}]

$VLAN_R2 config \
  -incrementStep 1 \
  -innerIncrement 1 \
  -firstId 1 \
  -uniqueCount 4094 \
  -idIncrMode 2 \
  -enabled false \
  -innerFirstId 1 \
  -innerIncrementStep 1 \
  -priority 1 \
  -increment 1 \
  -innerUniqueCount 4094 \
  -innerEnable false \
  -innerPriority 1
```

Configure the MAC addresses for the range.

Configure the VLAN tags for the range.

This page intentionally left blank.



# AppReplay

The IxLoad Application Replay API consists of the Application Replay Peer Agent and its commands.

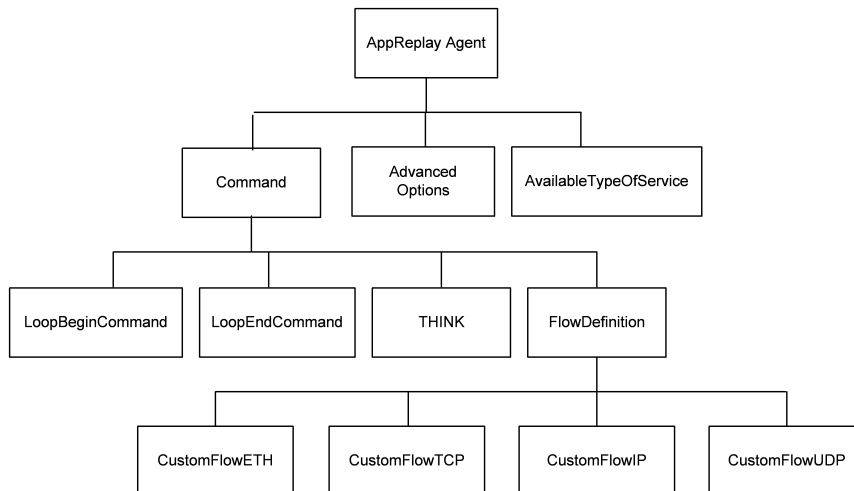

## Objectives

The objectives (userObjective) you can set for Application Replay are listed below. Test objectives are set in the ixTimeline object.

- simulatedUsers
- peerCount (displays as Initiator Peer Count in the GUI)
- connectionRate
- concurrentConnections
- throughputMbps
- throughputKbps
- throughputGbps
- transactionRate

## Application Replay Peer Agent

Application Replay Peer Agent - create an Application Replay agent

### SYNOPSIS

```
set Traffic1_Network1 [::IxLoad new ixNetTraffic]
set AppReplayPeer1 [$Traffic1_Network1 activityList.appendItem options...]
$AppReplayPeer1 agent.config
```

### DESCRIPTION

An ApplicationReplay peer agent is added to the activityList object. The activityList object is added to the ixNetTraffic object using the appendItem subcommand from the ixConfigSequenceContainer command.

### SUBCOMMANDS

The options for this command are configured and read using the standard config, cget, and getOptions subcommands defined in the ixConfig command.

### OPTIONS

enable

Enables the use of this client agent. (Default = true).

name

The name associated with this object, which must be set at object creation time.

concurrentObjectiveBehaviour

An optional parameter that is used to achieve the concurrent connections number to the configured value.

### STATISTICS

### EXAMPLE

```
set Traffic1_Network1 [::IxLoad new
ixNetTraffic]##### Activity AppRe-
playPeer1 of NetTraffic
Traffic1@Network1#####set Activity_AppRe-
playPeer1 [$Traffic1_Network1 activityList.appendItem \-protocolAndType
"AppReplay Peer" ]$Activity_AppReplayPeer1 agent.config \-
concurrentObjectiveBehaviour          1 \-enable
true \-name                            "AppReplayPeer1"
```

**SEE ALSO**

[ixNetTraffic](#)

## Flow Definition

FlowDefinition—Defines a remote peer activity and port.

### SYNOPSIS

```
set ServerTraffic1_ServerNetwork1 [::IxLoad new ixNetTraffic]
set Activity_AppReplayPeer1 [$Traffic1_Network1 activityList.appendItem \
-protocolAndType "AppReplay Peer" ]
$Activity_AppReplayPeer1 agent.pm.protocolFlows.appendItem
```

### DESCRIPTION

An option is added to the list of protocol flows using the `appendItem` subcommand from the `ixConfigSequenceContainer` command.

### SUBCOMMANDS

None

### OPTIONS

None.

### EXAMPLE

```
Activity_AppReplayPeer1 agent.pm.protocolFlows.clear$Activity_AppReplayPeer1 agent.p-
m.protocolFlows.appendItem \
-id "CustomFlowTCP" \
-captureFile "C:/Captures/httpuser.cap" \
-sessionSelectionLogic 0 \
-remotePeer "Traffic1_AppReplayPeer1" \
-responderPort80
-filt_InitiatorIP"198.18.0.1" \
-filt_ResponderPort"80" \
-filt_InitiatorPort "6140" \
-filt_ResponderIP"198.18.0.101" \
-overrideResponderPort false \
```

### SEE ALSO

[CustomFlowTCP](#)

## CustomFlowETH

Custom FlowETH — Replays an Ethernet flow.

### SYNOPSIS

```
$Activity_AppReplayPeer1 agent.pm.protocolFlows.appendItem
```

### DESCRIPTION

An option is added to the ProtocolFlows list using the appendItem subcommand from the ixConfigSequenceContainer command.

### SUBCOMMANDS

None

### OPTIONS

commandType

Type of AppReplay command.

Default = "CustomFlowEthernet"

cmdName

Name of the command.

Default = "CustomFlow - ETH <number>"

captureFile

Capture file, in cap or pcap format, that the TCP session is replayed from.

Default = "" (null)

interPacketTimeMultiplyingFactor

Amount of multiplication applied to inter-packet time interval in order to increase or decrease the replay speed

Min = 0.0, Max = 1000, Default = "1.0"

maintainInterPacketTime

If true, AppReplay attempts to maintain the same timing between consecutive packets in the replayed traffic as in the original flow. If false, AppReplay does not attempt to reproduce the timing between packets in the flow.

Default=false.

### EXAMPLE

```
$Activity_AppReplayPeer1 agent.pm.protocolFlows.appendItem \  
-commandType          "CustomFlowEthernet" \  
-interPacketTimeMultiplyingFactor 1.0 \  
-maintainInterPacketTime false \  
-cmdName              "Custom Flow - ETH 5" \  
-captureFile          ""
```

### SEE ALSO

[FlowDefinition](#)

## CustomFlowTCP

Custom FlowTCP —Specifies a custom TCP session, defined by a capture file, that is replayed between the initiator and the responder host.

### SYNOPSIS

```
$Activity_AppReplayPeer1 agent.pm.protocolFlows.appendItem
```

### DESCRIPTION

An option is added to the `ProtocolFlows` list of using the `appendItem` subcommand from the `ixConfigSequenceContainer` command.

### SUBCOMMANDS

None

### OPTIONS

`captureFile`

Capture file, in pcap format, that the TCP session is replayed from.

`sessionSelectionLogic`

The session logic determining the point in the capture file where replay of the TCP session starts from.

Value	Description
0	Follow First SYN. Replay starts from the first SYN packet found in the capture file. The initiator and responder addresses and port numbers are taken from the source IP, destination IP, source port, and destination port (respectively) in the first TCP SYN packet.
1	User-defined Filter. Replay starts from the first SYN packet found in the capture file that matches the filter criteria. To configure the filter, the initiator and responder addresses and port numbers have to be defined.

`filt_InitiatorIP`

The initiator IP in case a user-defined filter has been chosen.

`filt_ResponderIP`

The responder IP in case a user-defined filter has been chosen.

`filt_InitiatorPort`

The initiator port in case a user-defined filter has been chosen.

`filt_ResponderPort`

The responder port in case a user-defined filter has been chosen.

`overrideResponderPort`

If `true`, enables you to override the responder port number defined in the `FlowDefinition` object. If `false`, the responder port is set according to the filter configuration.

`max_persistent_requests`

Configures the number of flow replays that can occur over a single TCP connection.

Value	Description
0	Maximum Possible. All iterations take place over the same connection, for as long as the connection remains up.
1	Up to. You specify the number of iterations that can occur over a single connection in the <code>persistent_requests_count</code> parameter.

`persistent_requests_count`

If `max_persistent_requests = 1`, this is the number of requests that can occur over a single connection. Min="0", max="2147483647", default="1". Zero value signifies maximum possible.

### EXAMPLE

```
Activity_AppReplayPeer1 agent.pm.protocolFlows.clear

$Activity_AppReplayPeer1 agent.pm.protocolFlows.appendItem \
-id "CustomFlowTCP" \
-captureFile "C:/Captures/http1user.cap" \
-sessionSelectionLogic 0 \
-remotePeer "Traffic1_AppReplayPeer1" \
-responderPort80
-filt_InitiatorIP"198.18.0.1" \
-filt_ResponderPort"80" \
-filt_InitiatorPort "6140" \
-filt_ResponderIP"198.18.0.101" \
-overrideResponderPort false
```



**SEE ALSO**

[FlowDefinition](#)

## CustomFlowIP

Custom FlowIP — Specifies a custom IP session, defined by a capture file, that is replayed between the initiator and the responder host.

### SYNOPSIS

```
$Activity_AppReplayPeer1 agent.pm.protocolFlows.appendItem
```

### DESCRIPTION

An option is added to the `ProtocolFlows` list of using the `appendItem` subcommand from the `ixConfigSequenceContainer` command.

### SUBCOMMANDS

None

### OPTIONS

`commandType`

Name of the command. Default = "CustomFlowIP"

`flow_name`

Name of the flow. Default = "" (null)

`cycleThroughInitiatorPortUDP`

If `true` and this Custom Flow-IP command is run more than once during a test, different UDP port numbers are used each time the command runs. Specify the UDP port range in `udpPortRange`. Default = "false"

`cycleThroughInitiatorPortTCP`

If `true` and this Custom Flow-IP command is run more than once during a test, different TCP port numbers are used each time the command runs. Specify the TCP port range in `tcpPortRange`. Default = "false"

`captureFile`

Capture file, in pcap format, that the TCP session is replayed from. Default = "" (null)

`destination`

Destination of the traffic from the initiator:

- If the destination is a DUT, this is the IP address of the DUT.
- If the destination is another AppReplay peer, this is the name of the AppReplay activity.

Default = "None"

`packetSelectionLogic`

The packet selection logic determining the point in the capture file where replay of the TCP session starts from.

Value	Description
0 (Default)	Follow first IP Packet. Replay starts from the first IP packet found in the capture file.
1	User-defined Filter. Replay starts from the first IP packet found in the capture file that matches the filter criteria. To configure the filter, define the initiator and responder IP addresses and port numbers ( <code>filt_InitiatorIP</code> , <code>filt_ResponderIP</code> , <code>filt_InitiatorPort</code> , and <code>filt_ResponderPort</code> ).

`filt_InitiatorIP`

If `sessionSelectionLogic=1`, this parameter defines the initiator IP of the packet to begin playback from. Default=""(null).

`filt_ResponderIP`

If `sessionSelectionLogic=1`, this parameter defines the responder IP of the packet to begin playback from. Default=""(null).

`filt_InitiatorPort`

If `sessionSelectionLogic=1`, this parameter defines the initiator port of the packet to begin playback from. Specify "[ANY]" for any port. Default=""(null).

`filt_ResponderPort`

If `sessionSelectionLogic=1`, this parameter defines the responder port of the packet to begin playback from. Specify "[ANY]" for any port. Default=""(null).

`maintainInterPacketTime`

If `true`, AppReplay attempts to maintain the same timing between consecutive packets in the replayed traffic as in the original flow. If `false`, AppReplay does not attempt to reproduce the timing between packets in the flow. Default=`false`.

`interPacketTimeMultiplyingFactor`

Amount of multiplication applied to inter-packet time interval in order to increase or decrease the replay speed

Min = 0.0, Max = 1000, Default = "1.0"

`overrideResponderPortTCP`

If `true`, you can override the responder port number defined in the `FlowDefinition` object. If `false`, the responder port is set according to the filter configuration. Default=`false`.

`responderPortTCP`

TCP port number that responding peer listens on. Default=10000.

By default, this parameter is read-only. If `overrideResponderPortTCP` is `true`, you can change the port number. If you change the port number, the responding peer automatically updates itself with the new port number.

`overrideResponderPortUDP`

If `true`, you can override the responder port number defined in the `FlowDefinition` object. If `false`, the responder port is set according to the filter configuration. Default=`false`.

`preserveIPHeader`

If `true`, the IP header is preserved.

Default = `false`

`responderPortUDP`

UDP port number that responding peer listens on. Default=10000

By default, this parameter is read-only. If `overrideResponderPortUDP` is `true`, you can change the port number. If you change the port number, the responding peer automatically updates itself with the new port number.

`tcpPortRange`

Range of TCP port numbers used for traffic from this peer. Default="" (null)

`udpPortRange`

Range of UDP port numbers used for traffic from this peer. Default="" (null)

`useIPAdressFromCaptureFile`

If `true`, the replayed traffic uses the same IP addresses as the original flow in the capture file. Default=`false`

## EXAMPLE

```
$Activity_AppReplayPeer1 agent.pm.protocolFlows.clear
$Activity_AppReplayPeer1 agent.pm.protocolFlows.appendItem \
-id                "CustomFlowIP" \
-cycleThroughInitiatorPortUDP    false \
-flow_name         "CustomFlow3" \
-filt_InitiatorIP  "" \
-udpPortRange     "" \
```

---

```
-packetSelectionLogic      0 \  
-cycleThroughInitiatorPortTCP  false \  
-destination              "None" \  
-overrideResponderPortTCP  false \  
-tcpPortRange             "" \  
-maintainInterPacketTime   false \  
-overrideResponderPortUDP  false \  
-responderPortUDP         10000 \  
-responderPortTCP         10000 \  
-filt_ResponderPort       "" \  
-captureFile              "" \  
-filt_ResponderIP         "" \  
-useIPAddressFromCaptureFile false \  
-filt_InitiatorPort       ""
```

**SEE ALSO**

[FlowDefinition](#)

## LoopBeginCommand

LoopBeginCommand — Specifies the beginning of a command loop.

### SYNOPSIS

```
$Activity_AppReplayPeer1 agent.pm.protocolFlows.appendItem
```

### DESCRIPTION

An option is added to the `ProtocolFlows` list of using the `appendItem` subcommand from the `ixConfigSequenceContainer` command.

### SUBCOMMANDS

None

### OPTIONS

`id`

Name of the command. Default = "LoopBeginCommand"

`LoopCount`

Number of times the loop is executed. Default = 5. Min=0, Max = 2147483647.

### EXAMPLE

```
$Activity_AppReplayPeer1 agent.pm.protocolFlows.appendItem \  
-id "LoopBeginCommand" \  
-LoopCount 5
```

### SEE ALSO

## LoopEndCommand

LoopEndCommand — Specifies the end of a command loop.

### SYNOPSIS

```
$Activity_AppReplayPeer1 agent.pm.protocolFlows.appendItem
```

### DESCRIPTION

An option is added to the `ProtocolFlows` list of using the `appendItem` subcommand from the `ixConfigSequenceContainer` command.

### SUBCOMMANDS

None

### OPTIONS

`id`

Name of the command. Default = "LoopEndCommand"

### EXAMPLE

```
$Activity_AppReplayPeer1 agent.pm.protocolFlows.appendItem \  
-id "LoopEndCommand"
```

### SEE ALSO

## Think

THINK — Pauses execution of a command loop.

### SYNOPSIS

```
$Activity_AppReplayPeer1 agent.pm.protocolFlows.appendItem
```

### DESCRIPTION

An option is added to the `ProtocolFlows` list of using the `appendItem` subcommand from the `ixConfigSequenceContainer` command.

### SUBCOMMANDS

None

### OPTIONS

`id`

Name of the command. Default = "THINK".

`minimumInterval`

Minimum length of time to pause, in ms. Default = 1000. Min = 1, Max = 2147483647.

`maximumInterval`

Maximum length of time to pause, in ms. Default = 1000. Min = 1, Max = 2147483647.

### EXAMPLE

```
$Activity_AppReplayPeer1 agent.pm.protocolFlows.appendItem \  
-id "LoopEndCommand"
```

### SEE ALSO



## availableTosList

availableTosList — Create a list of available TOS choices.

### SYNOPSIS

```
$Activity_<activity name> agent.pm.availableTosList.appendItem
```

### DESCRIPTION

An option is added to the `availableTosList` using the `appendItem` subcommand from the `ixConfigSequenceContainer` command.

### SUBCOMMANDS

None

### OPTIONS

`id`

Name of the list. Default = "AvailableTypeOfService".

`tos_value`

TOS value to be added to the list. Default = "Best Effort 0x0".

If you want to specify the standard choices that are in the GUI, you can use a string representation. The choices are:

Value	Description
"Best Effort (0x0)"	(Default) routine priority
"Class 1 (0x20)"	Priority service, Assured Forwarding class 1
"Class 2 (0x40)"	Immediate service, Assured Forwarding class 2
"Class 3 (0x60)"	Flash, Assured Forwarding class 3
"Class 4 (0x80)"	Flash-override, Assured Forwarding class 4
"Express Forwarding (0xA0)"	Critical-ecp
"Control (0xC0)"	Internet-control

### EXAMPLE

```
$Activity_AppReplayPeer1 agent.pm.availableTosList.clear
```

```
$Activity_AppReplayPeer1 agent.pm.availableTosList.appendItem \  
-id                "AvailableTypeOfService" \  
-tos_value         "Class 1 (0x20)"
```

### **SEE ALSO**

## Advanced Options

AdvancedOptions—Defines the App Replay client's global options.

### SYNOPSIS

```
$Activity_AppReplayPeer1 agent.pm.advOptions.config \
-max_concurrent_flows1 \
-payloadVerification0 \
-typeOfService"Best Effort (0x0)" \
-enableTOSfalse
```

### DESCRIPTION

Defines the App Replay client's global options.

### SUBCOMMANDS

None

### OPTIONS

enableTOS

Enables the setting of the TOS (Type of Service) bits in the IP header of the packets.

Value	Description
0	(default) TOS bits not enabled.
1	TOS bits enabled.

enableOOSforUDP

Enables out-of-sequence packet handling for UDP packets.

Value	Description
0	(default) Disabled.
1	Enabled.

max\_concurrent\_flows

Maximum number of flows that each simulated user can send at one time. Default = 1.

payloadVerification

Packet payload is being verified based on the following two options:

- `Verify Content (0)`: The content of the payload is verified byte-by-byte against the expected payload. This verification option is set by default.
- `Verify Length (1)`: The length of the payload is verified against the expected value. Choosing this option yields better throughput performance.

`retransmissionDelayIPReplay`

Length of time that can elapse before a packet is retransmitted.

Default = 10

`sessionTimeOut`

Time, in seconds, to wait for a response from the responder peer.

Default = 600

`enableAdvanceStats`

If true, advanced statistics are collected.

Default = false

`typeOfService`

Type of Service (TOS) bits in the replayed packets. See `availableTosList` for the list of choices.

Default = "Best Effort (0x0)"

`retransmissionCountIPReplay`

Maximum number of times a packet can be retransmitted.

Default = 1

`enableRetransmissionIPReplay`

Enables retransmission of packets.

Default = false

`useIPAddressFromCaptureFile`

Determines the source of the IP addresses used by the peer during the test.

- If true the peer uses the IP addresses from the capture file.
- If false, the peer uses the IP addresses from the network that it runs over.

Default = false

`instrumentationModeUDP`

Default = 0

### EXAMPLE

```
$Activity_AppReplayPeer1 agent.pm.advOptions.config \-max_concurrent_flows
```

```
1 \-enableTOS                                false \-payloadVerification
1 \-enableOOSforUDP                          false \-enableAdvanceStats
false \-typeOfService                        "Best Effort (0x0)" \-
SeqNumInPayload                               01
```

**SEE ALSO**

## Global Statistics

The following table describes the global statistics for the Application Replay peer. AppReplay statistics are available on both a global basis and per-flow.



**Note:** The segment latency statistics are only displayed if you enable Advanced Statistics on the Advanced Options tab.

Statistic	Description
Test Objective Statistics	
AppReplay Application Initiator Peer Count	Number of Application Replay initiator peers created.
AppReplay Application Responder Peer Count	Number of Application Replay responder peers created.
AppReplay Connection Rate	Rate (in connections per second) at which Application Replay peers connected to each other.
AppReplay Concurrent Connections	Number of concurrent connections established between peers.
AppReplay Transaction Rate	Rate (in transactions per second) at which Application Replay peers completed transactions. For Application Replay peers, one transaction consists of a Layer-7 protocol's request packet, and the responses to that packet.
AppReplay Initiator Total Bytes Sent/sec	Rate at which the initiators sent data.
AppReplay Application Initiator Total Bytes Received/sec	Rate at which the initiators received data.
AppReplay Initiator Total Throughput	Combined rate at which the initiators sent and received data.

AppReplay Responder Total Bytes Sent/sec	Rate at which the responders sent data.
AppReplay Responder Total Bytes Received/sec	Rate at which the responders received data.
AppReplay Responder Total Throughput	Combined rate at which the responders sent and received data.
Total Connection Statistics	
AppReplay Connection Requests Sent	Number of connection requests sent by the initiators to the responders.
AppReplay Connection Requests Successful	Number of connection attempts that succeeded.
AppReplay Connection Requests Failed	Number of connection attempts that failed.
AppReplay Connection Requests Received	Number of connection requests received by the responders.
AppReplay Connections Accepted	Number of connections accepted by the responders. This statistic measures the number of successful connections from the point of view of the responder.
AppReplay Connections Failed	Number of connections that were established but then closed because they would have exceeded the maximum number of connections that the responder could support. The maximum number of connections that the responder can accept is calculated based on the test configuration and depends on the resources available on the load module, such as memory.
AppReplay Active Connections	Number of connections currently active.
Total Transaction Statistics	

AppReplay Total Transactions Initiated	Total number of TCP or UDP transactions initiated.
AppReplay Total Transactions Successful	Total number of TCP or UDP transactions that succeeded.
Total Flow Replay Statistics	
AppReplay Total Flow Replays Initiated	Total number of TCP, IP, or UDP flow replays initiated. A TCP flow consists of a SYN, SYN+ACK, FIN, and FIN+ACK packets, all for the same session.  To be considered valid, a flow must begin with a SYN packet, and end with packets from both the initiator and the responder with the FIN flag set, or a RESET.
AppReplay Total Active Flow Replays	Total number of flows being replayed.
AppReplay Total Flow Replays Succeeded	Total number of flows replayed successfully.
AppReplay Total Flow Replays Failed	Total number of flow replays that failed for any reason.
AppReplay Total Flow Replays Failed Error	Total number of flow replays that failed due to a network error.
AppReplay Total Flow Replays Failed Timeout	Total number of flow replays that failed due to a timeout.
AppReplay Total Flow Replays Failed Mismatch	Total number of flow replays that failed because the replayed session did not match the session in the pcap file.
AppReplay Total Flow Replays Aborted	Total number of flow replays aborted for any reason. Aborted flows are flows in which the session is terminated abnormally. Flows can be aborted if a Reset is received from the far end, or the test is forcefully stopped while sessions are in progress, or for other reasons.



Initiator Total Bytes Statistics	
AppReplay Initiator Total Bytes Sent	Total number of bytes sent by the initiators.
AppReplay Initiator Total Bytes Received	Total number of bytes received by the initiators.
AppReplay Initiator Total Bytes Sent and Received	Combined total of bytes sent and received by the initiators.
Responder Total Bytes Statistics	
AppReplay Responder Total Bytes Sent	Total number of bytes sent by the responders.
AppReplay Responder Total Bytes Received	Rate at which the responders received data.
AppReplay Responder Total Bytes Sent and Received	Combined total number of bytes sent and received by the responders.
Control Tx/Rx Statistics	
AppReplay Segment Transmission Initiated	<p>Number of segments for which transmission has begun. Segments are counted based on how they are formed in the capture file. For example, if one segment in the capture file becomes split between two segments while being replayed, it is still counted as only one segment when it is received.</p> <p>Conversely, if two segments in the capture file are packed into a single segment during replay, they are counted as two segments.</p>
AppReplay Segment Transmission Succeeded	Number of segments successfully transmitted (Initiator side).
AppReplay Segment Transmission Failed	Total number of segments that failed transmission (Initiator side).
AppReplay Segment Transmission Failed (Error)	Number of segments that failed transmission due to a network error (Initiator side).

AppReplay Segment Transmission Failed (Timeout)	Number of segments that failed transmission due to a timeout (Initiator side).
AppReplay Segment Reception Initiated	Number of segments that the responders are receiving.
AppReplay Segment Reception Succeeded	Number of segments successfully received (Responder side).
AppReplay Segment Reception Failed	Total number of segments that were not received (Responder side).
AppReplay Segment Reception Failed (Error)	Number of segments that were not received due to a network error (Responder side).
AppReplay Segment Reception Failed (Timeout)	Number of segments that were not received due to a timeout (Responder side).
AppReplay Segment Reception Failed (Mismatch)	Number of segments received that did not match the segments in the pcap file (Responder side).
AppReplay UDP Lost Packets	Number of UDP packets that were transmitted but not received.
AppReplay UDP Out Of Sequence Packets	Number of UDP packets received out of sequence. This statistic only displays if <i>Enable Out of Sequence Packet Handling for UDP</i> is enabled on the Advanced Options tab.
AppReplay IP Packet Retransmission Count	Number of retransmitted IP packets. If a packet is retransmitted more than once, this statistic is incremented each time the packet is retransmitted. This statistic is incremented only if Enable Retransmission for Custom Flow IP is enabled on the Application Replay Advanced tab.
AppReplay Out Of Sequence IP Packet Count	Number of IP packets received out of sequence. This statistic is incremented only if Enable Retransmission for Custom Flow IP is enabled on the Application Replay Advanced tab.
Packet Latency Statistics	

<p>Inter Segment First Response Latency (for Initiated Flows)</p>	<p>The average delay between the time the initiator receives the first segment from the responder, after the initiator has sent a segment to the responder. In the diagram below, this statistic calculates latency by measuring time at the following points:</p> <p>A2 - A1 A4 - A3 A7 - A6</p> <p>This statistic displays a value only if the initiator has sent a segment prior to receiving a segment.</p> <p>Note for Tcl API users: This is a weighted statistic. If you are using this statistic in a Tcl script, use the <i>kWeightedAverage</i> aggregation type.</p>
<p>Inter Segment Last Response Latency (for Responded Flows)</p>	<p>The average delay between the time the responder receives the first segment from the initiator, after the responder has sent a segment to the initiator. In the diagram below, this statistic calculates latency by measuring time at the following points:</p> <p>B3 - B2 B5 - B4 B8 - B7</p> <p>This statistic displays a value only if the responder has sent a segment prior to receiving a segment.</p> <p>Note for Tcl API users: This is a weighted statistic. If you are using this statistic in a Tcl script, use the <i>kWeightedAverage</i> aggregation type.</p>
<p>Inter Segment Last Response Latency (for Initiated Flows)</p>	<p>The average delay between the time the initiator receives the final segment from the responder, after the initiator has sent a segment to the responder. The received segment is considered the final segment if the flow ends after this segment, or if the initiator sends a segment after this segment. In the diagram below, this statistic calculates latency by measuring time at the following points:</p> <p>A3 - A1 A5 - A3 A8 - A6</p> <p>This statistic displays a value only if the initiator has sent a segment prior to receiving the final segment.</p> <p>Note for Tcl API users: This is a weighted statistic. If you are using this statistic in a Tcl script, use the <i>kWeightedAverage</i> aggregation type.</p>

<p>Inter Segment Last Response Latency (for Responded Flows)</p>	<p>The average delay between the final segment received by the responder from the initiator after the responder sent a segment to the initiator.</p> <p>The received segment is considered the final segment if the flow ends after this, or if the initiator sends a segment after this.</p> <p>In the diagram below, this statistic calculates latency by measuring time at the following points:</p> <p>B3 - B2 B6 - B4 B8 - B7</p> <p>This statistic displays a value only if the responder has sent a segment prior to receiving the final segment.</p> <p>Note for Tcl API users: This is a weighted statistic. If you are using this statistic in a Tcl script, use the <i>kWeightedAverage</i> aggregation type.</p>
<p>Session Life Time (for Initiated Flows)</p>	<p>The average duration between the time the initiator sends or receives the first segment and sends or receives the final segment over a TCP session.</p> <p>In the diagram below, this statistic calculates latency by measuring time at the following points:</p> <p>A8 - A1</p> <p>Note for Tcl API users: This is a weighted statistic. If you are using this statistic in a Tcl script, use the <i>kWeightedAverage</i> aggregation type.</p>
<p>Session Life Time (for Responded Flows)</p>	<p>The average duration between the time the responder sends or receives the first segment and sends or receives the final segment over a TCP session.</p> <p>In the diagram below, this statistic calculates latency by measuring time at the following points:</p> <p>B8 - B1</p> <p>Note for Tcl API users: This is a weighted statistic. If you are using this statistic in a Tcl script, use the <i>kWeightedAverage</i> aggregation type.</p>

The following diagram shows an example of segment exchanges in an AppReplay session and identifies the points at which the Latency statistics are measured. The diagram assumes peer A is running as an Initiator only and peer B is a Responder only.

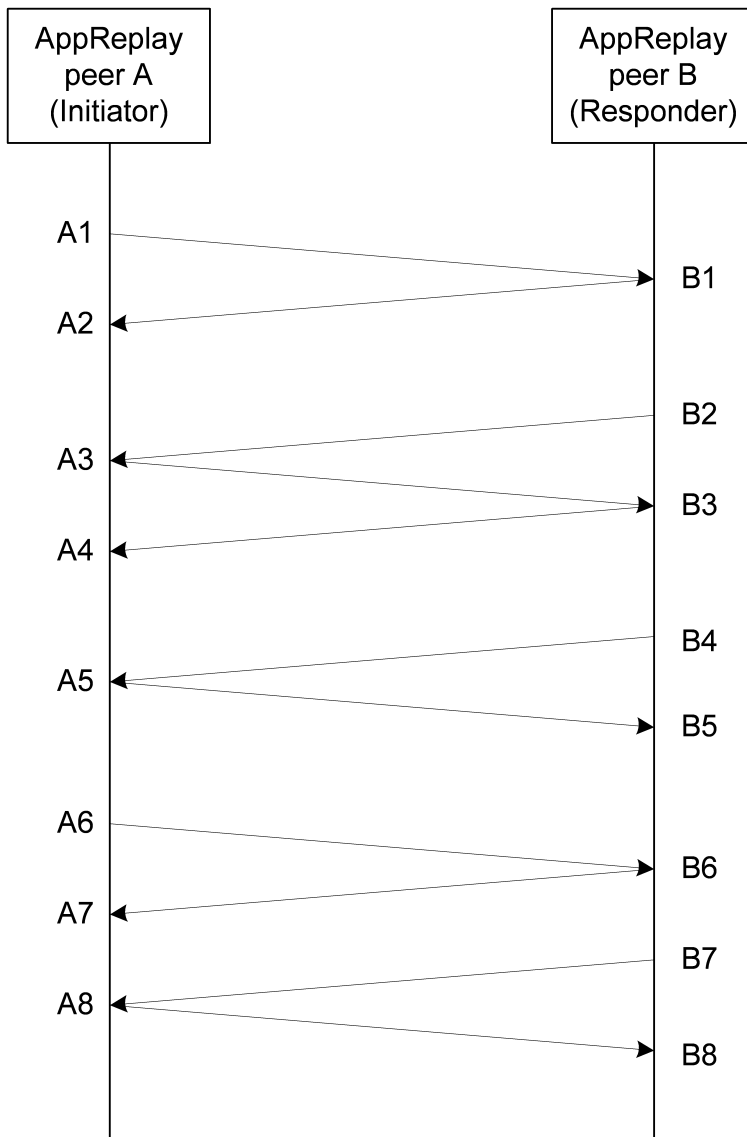

This page intentionally left blank.

## AppMix

This section describes the AppMix Tcl API.



**Note:** You must use the IxLoadCSV package with AppMix scripts.

## Creating an AppMix Object

ixTrafficMix

### SYNOPSIS

```
set TrafficMix [::IxLoad new ixTrafficMix]
```

```
$New_Scenario trafficMixList.appendItem -object $TrafficMix
```

### DESCRIPTION

New instances of TrafficMix objects are created in TCL using the ixTrafficMix constructor. After being configured, the TrafficMix objects are added to scenario.trafficMixList

TrafficMix objects expose to TCL certain fields: the list of flows, a list of endpoints, and the name.

The name is set using the config method.

### SUBCOMMANDS

None.

### OPTIONS

The options for this command are configured and read using the standard `config`, `cget`, and `getOption` subcommands defined in the `ixConfig` command.

### STATISTICS

### EXAMPLE

```
set TrafficMix [::IxLoad new ixTrafficMix]
```

```
$New_Scenario trafficMixList.appendItem -object $TrafficMix
```

### SEE ALSO



---

## Adding Flows to an AppMix Object

### SYNOPSIS

```
set flow [$flowFactory create "<flow name>"]
$TrafficMix flowList.appendItem -object $flow
```

### DESCRIPTION

Flows are created in TCL using the flowFactory field of the traffic mix object. The flow factory instance is set when creating the mix, and can be retrieved in TCL using the getFlowFactory method.

Creating a new flow is done using the create method of the flowFactory object. This method receives a protocol ID as a parameter, and is exposed to the TCL script.

### SUBCOMMANDS

None.

### OPTIONS

The options for this command are configured and read using the standard `config`, `cget`, and `getOption` subcommands defined in the `ixConfig` command.

### STATISTICS

### EXAMPLE

```
$TrafficMix flowList.clearset flowFactory [$TrafficMix getFlowFactory]set flow
[$flowFactory create "HTTP"]$TrafficMix flowList.appendItem -object $flow
```

### SEE ALSO

## Setting Flow Parameters

### SYNOPSIS

```
set flowEndpoint_client [$flow getClientFlowEndpoint]
```

### DESCRIPTION

When created, a flow automatically creates instances for its endpoints. To access endpoints from the TCL in order to assign them to traffic mix endpoints, there are two methods: `getClientFlowEndpoint` and `getServerFlowEndpoint`.

`getClientFlowEndpoint` method takes no argument, and returns the Originator flow endpoint. The `getServerFlowEndpoint` method receives as an argument the index of the required server endpoint in the flow endpoint list.

### SUBCOMMANDS

None.

### OPTIONS

### STATISTICS

### EXAMPLE

```
set flowEndpoint_client [$flow getClientFlowEndpoint] set flowEndpoint_server [$flow  
getServerFlowEndpoint 0]
```

### SEE ALSO

---

## Configuring Flow Commands

### SYNOPSIS

```
set <method name> [$flow commandList.appendItem -commandType "<command>" -protocol "<flow name>"]
```

### DESCRIPTION

A flow contains a list of commands. These are commands from all protocols inside a flow's list. In the TCL script, the command list is cleared, and you can edit the number of executed commands, and can add one or more of the available commands. Adding a command is done with the `appendItem` method of the command list. The `appendItem` method is called with one or two arguments:

- The `'command type'` argument specifies what command should be added (the command name). This argument is mandatory in creating a command
- The `'protocol'` argument is optional, and specifies for what protocol in the protocol list the command should be created. If the argument is not given, all the protocols will be parsed until finding a protocol that contains a command with the given name.

A command may contain a list of parameters, that are configured the same as the flow parameters.

### SUBCOMMANDS

None.

### OPTIONS

### STATISTICS

### EXAMPLE

```
set HTTP_Get [$flow commandList.appendItem -commandType "Get"]set HTTP_Get [$flow commandList.appendItem -commandType "Get" -protocol "HTTP"]
```

### SEE ALSO

## Flow Protocols

### SYNOPSIS

```
set <method name> [$flow getProtocol "<protocol>"]
```

### DESCRIPTION

Protocols can be retrieved from the protocol list using the `getProtocol` method. This method receives as an argument the protocol's ID.

```
set HTTP1_protocol [$flow getProtocol "HTTP"]
```

The protocol exposes to the TCL script a list of connections, and a list of parameters. The parameters are configured identically as the flow parameters. The protocol also contains a list of endpoints, but this are created when parsing the protocol XML, and assigned automatically to the flow endpoints. You cannot configure the protocol endpoints in TCL.

You cannot specify a new connection. These are automatically created. In order to retrieve a connection in TCL, call the `getConnection` method with the connection display name as an argument:

```
set HTTP2_connection [$HTTP1_protocol getConnection "HTTP"]
```

The connection contains a list of connection parameters which are configured in the same way as flow parameters.

The flow also exposes to TCL a transaction list, and the percentage and flow name:

```
$flow transactionList.clear$flow config \-percentage  
1.0 \-name "HTTP"
```

### SUBCOMMANDS

None.

### OPTIONS

### STATISTICS

### EXAMPLE

```
$flow transactionList.clear$flow config \-percentage  
1.0 \-name "HTTP"
```

**SEE ALSO**

## Setting Flow Endpoints

### SYNOPSIS

```
set <parameter> [$flow cget -<parameter>]
```

### DESCRIPTION

The flow parameters are created automatically when creating the flow. Parameters are retrieved from the parent list using the cget method that receives as an argument the parameter ID. After getting the parameter, you can define its source, value and encodings fields.

Besides the flows, all protocol, command and connection instances contain parameters. All these parameters are configured in the same way.

### SUBCOMMANDS

None.

### OPTIONS

### STATISTICS

### EXAMPLE

```
set ipMeshing [$flow cget -ipMeshing]
$ipMeshing config \
-source           "Choices" \
-value           "1:1" \
-encodings       "Chunk"
```

### SEE ALSO

---

## Flow Endpoints

### SYNOPSIS

```
set my_ixTrafficMixEndpoint [::IxLoad new ixTrafficMixEndpoint]
```

### DESCRIPTION

New Traffic Mix endpoints can be added using the class constructor. The fields that are available for modifications in TCL are the flow endpoint list, the aliasName, and the netTraffic. The flow endpoint list can be assigned one or more flow endpoints (that are retrieved using the getClientFlowEndpoint and getServerFlowEndpoint methods).

### SUBCOMMANDS

None.

### OPTIONS

### STATISTICS

### EXAMPLE

```
set my_ixTrafficMixEndpoint [::IxLoad new ixTrafficMixEndpoint]$my_ixTraf-  
ficMixEndpoint flowEndpointList.clear$my_ixTrafficMixEndpoint flowEnd-  
pointList.appendItem -object $flowEndpoint_client$my_ixTrafficMixEndpoint config \-  
aliasName                "" \-netTraffic  
$Traffic1_Network1 $TrafficMix mixEndpointList.appendItem -object $my_ixTraf-  
ficMixEndpoint
```

### SEE ALSO

! 10

This page intentionally left blank.



## Bulk MGCP

This section describes the MGCP Tcl API objects.

## API Overview

The IxLoad MGCP API consists of MGCP client and server agents, with separate APIs for configuring each major aspect of the agents' functionality.

## MGCP Client API

The IxLoad MGCP Client API commands are organized as shown in the figure below.

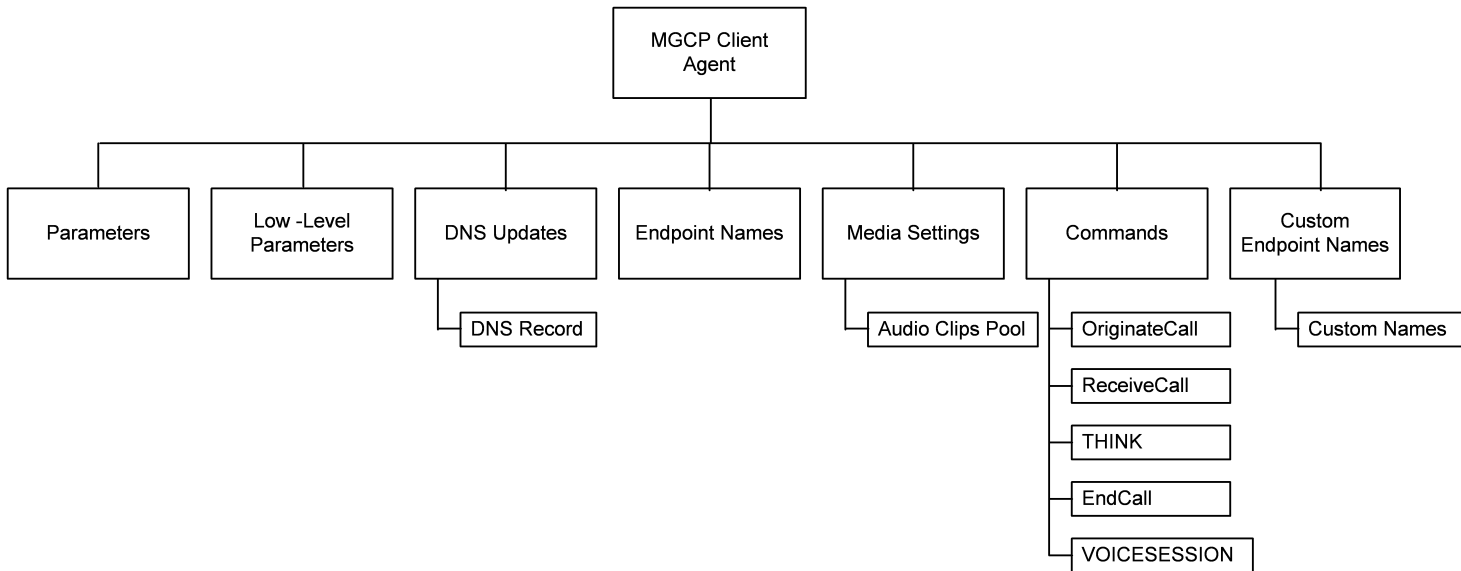

## Objectives

The objectives (userObjective) you can set for MGCP are listed below. Test objectives are set in the ixTimeline object.

- simulatedUsers
- calls (displays as “Endpoints” in the GUI)
- transactionRate
- bhca
- callsPerSec (displays as “Calls Initiated Per Second” in the GUI)

## MGCP Client Agent

The MGCP Client Agent creates an IxLoad agent that simulates an MGCP gateway. Refer to `MGCP Client Agent` on page 23-12 for a full description of this command. The most significant options of this command are listed below.

Option	Description
enable	Enables the use of this client agent.
name	The name associated with this object, which must be set at object creation time .
protocol	Protocol used by the client agent.
type	Defines the agent as either a client or server.

## Parameters

Sets an MGCP client’s basic parameters. Refer to `Parameters` on page 23-21 for a full description of this command. The most significant options of this command are listed below.

Option	Description
GatewaySourcePort	Source port for MGCP commands.
CallAgent_port	Call agent that controls this Gateway.
enableTosMGCP	Enable TOS for MGCP traffic.
type_of_service_for_mgcp	IP Precedence / TOS (Type of Service) bit setting and Assured Forwarding classes for MGCP.

enableTosRTP	Enables the setting of the TOS (Type of Service) bits in the header of the RTP data packets.
type_of_service_for_rtp	IP Precedence / TOS (Type of Service) bit setting and Assured Forwarding classes for RTP data packets.

## Low-Level Parameters

Sets an MGCP client's low-level parameters. Refer to `Low Level Parameters` on page 23-23 for a full description of this command. The most significant options of this command are listed below.

Option	Description
CommandTimeout	Command timeout.
LocalMediaProperties	String containing the encoding of endpoint media parameters.
AcknowledgeResponses	Specifies if the sent command will include K parameter with the ID of last received response.

## DNS Record

Adds a DNS record to the list to be sent to a DNS server. Refer to `DNS Record` on page 23-24 for a full description of this command. The most significant options of this command are listed below.

Option	Description
dns_record_time_to_live	Used for DNS update query to specify time of validity of the updated DNS record.
dns_ip_port	Hostname:port number or IP address:port number of DNS server to which DNS records will be sent.

## Endpoint Names

Adds a DNS record to the list to be sent to a DNS server. Refer to `Endpoint Names` on page 23-25 for a full description of this command. The most significant options of this command are listed below.

Option	Description
GatewayName	Gateway IP address:port or domain name:port.
NumberOfEndpoints	Number of endpoints hosted by the gateway.
UseCustomNames	Specifies whether to use custom names or not.
EndpointNamePrefix	Prefix applied to endpoint name.
EndpointNameSuffix	Suffix applied to endpoint name.
EndpointNameStartAt	Initial value of variable portion of endpoint name.
EndpointNameExpan	Width of variable used to create endpoint names that are unique within a gateway.
EndpointNameStep	Amount of increase in the variable (the Endpoint Name Expand On parameter) used to create unique base endpoint names.
EndpointPhonePrefix	String containing digits to be used at beginning of phone num
EndpointPhoneSuffix	String containing digits to be used at the end of the phone number.
EndpointPhoneStartAt	Initial value of variable portion of phone number.
EndpointPhoneStep	Amount of increase in variable to create additional phone numbers.
NumGateways	Number of gateways.
GatewayNamePrefix	String prefixed to gateway name.
GatewayNameSuffix	String suffixed to gateway name.
GatewayNameStartAt	Initial value of variable portion of gateway name.
GatewayNameExpan	Width of variable used to create unique gateway names.
GatewayNameStep	Amount of increase in variable used for gateway name.

## Media Settings

Selects and configure the streaming audio files for the multimedia session that the client will play over RTP. Refer to `Media Settings` on page 23-27 for a full description of this command. The most

significant options of this command are:

Option	Description
szCodecName	Codec to be used to encode waveform audio files listed in the Audio Clips Pool.
szCodecDetails	Displays the properties of the codec such as the number of bytes per frame of compressed audio, and the rate at which packets are sent over the connection.
szCodecDescr	Codec description.
bModifyPowerLevel	If <code>true</code> , IxLoad modifies the volume of the compressed audio.
szPowerLevel	If <code>bModifyPowerLevel</code> is <code>true</code> , this parameter specifies the amount of gain (volume) added to compressed audio.
bUseJitter	Enables or disables use of the jitter buffer.
bJitMs	Defines the method used to set the jitter buffer size.
nJitterBuffer	Jitter Buffer size, in packets.
nJitterMs	Jitter Buffer size, in milliseconds.
bUseCompensation	Enables or disables use of the compensation jitter buffer.
bCompMs	Defines the method used to set the compensation jitter buffer size.
nCompJitterBuffer	Compensation jitter buffer maximum size, in packets.
nCompJitterMs	Compensation jitter buffer maximum size, in milliseconds.
nCompMaxDropped	Maximum dropped consecutive packets.
bUseMOS	Enables or disables use of MOS.
bMosOnMax	Defines whether MOS is calculated for a subset of streams or for all streams.
nMosMaxStreams	Maximum number of concurrent streams used in MOS calcu
nMosInterval	Frequency at which IxLoad samples the RTP streams to generate the MOS scores.
nDtmfDuration	Length of time allowed to play the DTMF sequence.
nDtmfInterdigits	Duration (in milliseconds) of the DTMF interdigit signal.
bLimitDtmf	Enable or disable limitation on the number of DTMF streams to be processed.

nDtmfStreams	Number of streams to which path confirmation will be applied.
nPcInterval	If Synthetic path confirmation is selected, this is the interval at which IxLoad add the synthetic RTP packets to the stream.
nSessionType	Type of voice session.
szDtmfSeq	DTMF sequence used for path confirmation.
szPeerCodecName	Name of codec used by peer.
szPeerCodecDetails	Details of codec used by peer.
szPeerDtmfSeq	DTMF sequence used by peer.
nPeerDtmfDuration	DTMF duration used by peer.
nPeerDtmfInterdigits	Inter-digits interval used by peer.
audioClipsTable	This list contains the waveform audio files that the MGCP cli will play.

## Commands

Creates the list of MGCP commands that the client will send. Refer to [Commands](#) on page 23-31 for a full description of this command. The most significant options of this command are listed below.

Option	Description
id	MGCP command to be executed.

## Audio Clips Pool

Defines an audio file to be included in the list that the MGCP client will play. Refer to [Audio Clips Pool](#) on page 23-33 for a full description of this command. The most significant options of this command are listed below.

Option	Description
szWaveName	Waveform audio (.wav) file.
szDataFormat	Encoding format of waveform audio file.

nSampleRate	Number of samples taken per second from the recording source.
nResolution	Number of bits per sample.
nChannels	Number of audio channels.
nDuration	Playing time of audio file.
nSize	Size of audio file, in bytes.
szRawWaveName	Name and path of wave file to be added to the list.

## Custom Endpoint Names

Retrieves the list of custom endpoint names generated by `Endpoint Names`. Refer to `Custom Endpoint Names` on page 23-34 for a full description of this command. The most significant options of this command are:

Option	Description
endpoint_names	List of custom endpoint names to be used.

## MGCP Server API

The figure below shows the MGCP Server API structure.

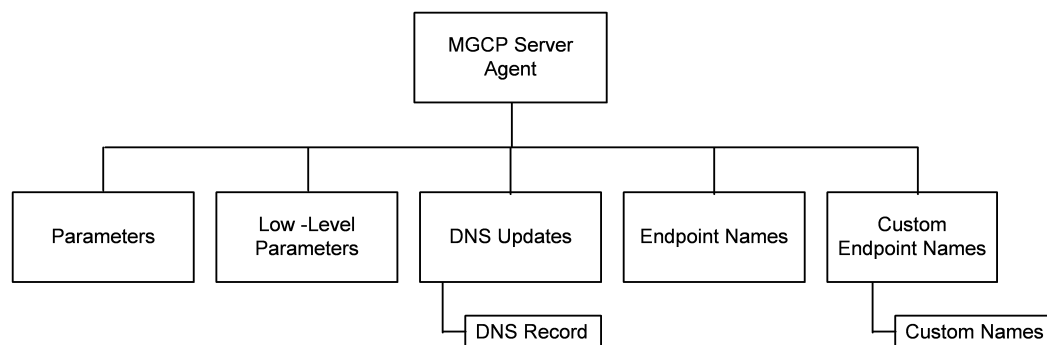

## MGCP Server Agent

The MGCP Server Agent command simulates an MGCP Call Agent. Refer to [MGCP Server Agent](#) on page 23-35 for a full description of this command. The most significant options of this command are listed below.

Option	Description
enable	Enables the use of this client agent.
name	The name associated with this object, which must be set at object creation time .
protocol	Protocol used by the client agent.
type	Defines the agent as either a client or server.

## Low-Level Parameters

Sets the MGCP Server Agent's low-level commands. Refer to [Low Level Parameters](#) on page 23-43 for a full description of this command. The most sigoptions of this command are listed below.

Option	Description
CommandTimeout	If no response to a command is received within this number of seconds, a error is declared.
AcknowledgeResponses	Specifies if the sent command will include the K parameter with the ID of last received response.

## DNS Updates

Configures the list of DNS records that will be sent to a DNS server. Refer to [DNS Updates](#) on page 23-44 for a full description of this command. The most significant options of this command are listed below.

Option	Description
--------	-------------



dns_record_time_to_live	Used for DNS update query to specify time of validity of the updated DNS record.
dns_source_ip	IP address indicated as the source of the DNS records.

## DNS Record

Configures a DNS record that will be added to the list to be sent to a DNS server. Refer to `DNS Record` on page 23-45 for a full description of this command. The most significant options of this command are:

Option	Description
dns_record_name	Name to be added to DNS database.
dns_record_address	IP address to be added to DNS database.

## Endpoint Names

Configures the names used for MGCP endpoints. Refer to `Endpoint Names` on page 23-46 for a full description of this command. The most significant options of this command are listed below.

Option	Description
NumberOfEndpoints	Number of endpoints hosted by the gateway.
UseCustomNames	Specifies whether to use custom names or not.
EndpointNamePrefix	Prefix applied to endpoint name.
EndpointNameSuffix	Suffix applied to endpoint name.
EndpointNameStartAt	Initial value of variable portion of endpoint name.
EndpointNameExpandOn	Width of variable used to create endpoint names that are unique within a gateway.
EndpointNameStep	Amount of increase in the variable (the Endpoint Name Expand On parameter) used to create unique base endpoint names.
EndpointPhonePrefix	String containing digits to be used at beginning of phone num

EndpointPhoneSuffix	String containing digits to be used at the end of the phone number.
EndpointPhoneStartAt	Initial value of variable portion of phone number.
EndpointPhoneStep	Amount of increase in variable to create additional phone numbers.
NumGateways	Number of gateways.
GatewayNamePrefix	String prefixed to gateway name.
GatewayNameSuffix	String suffixed to gateway name.
GatewayNameStartAt	Initial value of variable portion of gateway name.
GatewayNameExpandOn	Width of variable used to create unique gateway names.
GatewayNameStep	Amount of increase in variable used for gateway name.

## Custom Endpoint Names

Retrieves the list of custom endpoint names generated by `Endpoint Names`. Refer to `Custom Endpoint Names` on page 23-48 for a full description of this command. The most significant options of this command are listed below.

Option	Description
<code>endpoint_names</code>	List of custom endpoint names to be used.

## Parameters

### SYNOPSIS

```
set Traffic1_Network1 [::IxLoad new ixNetTraffic]
set Activity_MGCPClient1 [$Traffic1_Network1 activityList.appendItem options...]
$Activity_MGCPClient1 agent.pm.parameters.config
```

## DESCRIPTION

An MGCP server's basic parameters are set by modifying the options of the `pm.parameters` option of the MGCP Server Agent object using `appendItem`. Note the use of the `'pm.'` component in the name.

## SUBCOMMANDS

The options for this command are configured and read using the standard `config`, `cget`, and `getOption` subcommands defined in the `ixConfig` command.

## OPTIONS

`call_agent_name`

Call agent FQDN name that controls this gateway. (Default = "prica.ixi").

`listen_port_start`

Initial port that the agent listens on for new MGCP connections. Minimum = "1" maximum = "65,535." (Default = "2,727").

`listen_port_stop`

Number of ports that the agent listens on for new MGCP connections. Minimum = "1." (Default = "1").

`listen_port_step`

Increment value applied initially to `listen_port_start` and to each subsequent value to create the list of listening ports. Minimum = "1." (Default = "1").

`enableTosMGCP`

Enable TOS for MGCP traffic.

Value	Description
0	(default) TOS bits disabled.
1	TOS bits enabled.

`type_of_service_for_mgcp`

If `enableTosMGCP` is `true`, this option specifies the IP Precedence / TOS (Type of Service) bit setting and Assured Forwarding classes. (Default = "Best Effort 0x0"). If you want to specify the standard choices that are in the GUI, you can use a string representation. To specify any of the other 255 TOS values, specify the decimal value. The default choices are:

Value	Description
"Best Effort (0x0)"	(Default) routine priority

"Class 1 (0x20)"	Priority service, Assured Forwarding class 1
"Class 2 (0x40)"	Immediate service, Assured Forwarding class 2
"Class 3 (0x60)"	Flash, Assured Forwarding class 3
"Class 4 (0x80)"	Flash-override, Assured Forwarding class 4
"Express Forwarding (0xA0)"	Critical-ecp
"Control (0xC0)"	Internet-control

## MGCP Client Agent

MGCP Client Agent - configure an MGCP client

### SYNOPSIS

```
set Traffic1_Network1 [::IxLoad new ixNetTraffic]
set Activity_MGCPClient1 [$Traffic1_Network1 activityList.appendItem options...]
$Activity_MGCPClient1 agent.config
```

### DESCRIPTION

An MGCP client agent is added to the `activityList` object. The `activityList` object is added to the `ixNetTraffic` object using the `appendItem` subcommand from the `ixConfigSequenceContainer` command.

### SUBCOMMANDS

The options for this command are configured and read using the standard `config`, `cget`, and `getOptions` subcommands defined in the `ixConfig` command.

### OPTIONS

`enable`

Enables the use of this client agent. (Default = true).

`name`

The name associated with this object, which must be set at object creation time.

### STATISTICS

### EXAMPLE

```
set Traffic1_Network1 [::IxLoad new
ixNetTraffic]##### Activity MGCPClient1
of NetTraffic Traffic1@Network1#####set
Activity_MGCPClient1 [$Traffic1_Network1 activityList.appendItem \-protocolAndType
"MGCP Client" ]$Activity_MGCPClient1 agent.config \-enable
true \-name "MGCPClient1"
```

### SEE ALSO

[ixNetTraffic](#)

## Parameters

### SYNOPSIS

```
set Traffic1_Network1 [::IxLoad new ixNetTraffic]
set Activity_MGCPClient1 [$Traffic1_Network1 activityList.appendItem options...]
$Activity_MGCPClient1 agent.pm.parameters.config
```

### DESCRIPTION

An MGCP client's basic parameters are set by modifying the options of the `pm.parameters` option of the `MGCP Client Agent` object.

### SUBCOMMANDS

The options for this command are configured and read using the standard `config`, `cget`, and `getOption` subcommands defined in the `ixConfig` command.

### OPTIONS

`GatewaySourcePort`

Source port for MGCP commands. This may be changed by Call Agent by using `NotifiedEntity` parameter. Minimum = "1," maximum = "65535." (Default = "2,427").

`CallAgent_port`

Call agent that controls this Gateway. Example: `"192.168.8.9:2427"` or `prica.ixialab.com`. (Default = "None"). The following suboptions exist for this option:

Value	Description
<code>enableDns</code>	Enable (1) or disable (0) DNS for symbolic destinations (IxLoad agents) for this call agent. Default = 0.
<code>Protocol id</code>	ID of the call agent protocol issuing the DNS request. Default = "mgcp."

`enableTosMGCP`

Enable TOS for MGCP traffic.

Value	Description
0	(default) TOS bits not enabled.
1	TOS bits enabled.

`type_of_service_for_mgcp`

If `enableTosMGCP` is `true`, then this option specifies the IP Precedence / TOS (Type of Service) bit setting and Assured Forwarding classes. (Default = "Best Effort 0x0"). If you want to specify the standard choices that are in the GUI, you can use a string representation. To specify any of the other 255 TOS values, specify the decimal value. The default choices are:

Value	Description
"Best Effort (0x0)"	(Default) routine priority
"Class 1 (0x20)"	Priority service, Assured Forwarding class 1
"Class 2 (0x40)"	Immediate service, Assured Forwarding class 2
"Class 3 (0x60)"	Flash, Assured Forwarding class 3
"Class 4 (0x80)"	Flash-override, Assured Forwarding class 4
"Express Forwarding (0xA0)"	Critical-ecp
"Control (0xC0)"	Internet-control

`enableTosRTP`

Enables the setting of the TOS (Type of Service) bits in the header of the RTP data packets.

Value	Description
0	(default) TOS bits not enabled.
1	TOS bits enabled.

`type_of_service_for_rtp`

If `enableTosRTP` is `true`, this option specifies the IP Precedence / TOS (Type of Service) bit setting and Assured Forwarding classes for RTP data packets. See `type_of_service_for_mgcp` for the list of choices (Default = "Best Effort (0x0)").

### EXAMPLE

```
$Activity_MGCPClient1 agent.pm.parameters.config \-type_of_service_for_mgcp
"Best Effort (0x0)" \-CallAgent_port                "Traffic2_MGCPServer-
1:2727" \-type_of_service_for_rtp                  "Best Effort (0x0)" \-enableTosRTP
true \-CallAgent                                  "" \-GatewaySourcePort
2427 \-enableTosMGCP                               true \-implicitLoopCheck
true
```

### SEE ALSO

[ixNetTraffic](#)





## Low Level Parameters

### SYNOPSIS

```
set Traffic1_Network1 [::IxLoad new ixNetTraffic]
set Activity_MGCPClient1 [$Traffic1_Network1 activityList.appendItem options...]
$Activity_MGCPClient1 agent.pm.ll_parameters.config
```

### DESCRIPTION

An MGCP client's low-level parameters are set by modifying the options of the `pm.ll_parameters` option of the `MGCP Client Agent` object.

### SUBCOMMANDS

None.

### OPTIONS

`CommandTimeout`

If no response to a command is received within this number of seconds, a error is declared. Minimum = "1," Maximum = "120." (Default = "30").

`LocalMediaProperties`

String containing the encoding of endpoint media parameters. Default = "v:on, e:off,"  
maxLength = "2,048."

`AcknowledgeResponses`

Specifies if the sent command will include the K parameter with the ID of last received response. (Default = "0").

### EXAMPLE

```
$Activity_MGCPClient1 agent.pm.ll_parameters.config \-LocalMediaProperties
"v:on, e:off" \-CommandTimeout 30 \-AcknowledgeResponses
true \-RingCount 2
```

### SEE ALSO

[MGCP Client Agent](#)

## DNS Record

### SYNOPSIS

```
set Traffic1_Network1 [::IxLoad new ixNetTraffic]
set Activity_MGCPClient1 [$Traffic1_Network1 activityList.appendItem options...]
$Activity_MGCPClient1 agent.pm.dns_update_parameters.config
```

### DESCRIPTION

The `DNS Update Parameters` command is used to add DNS records to the list of records that will be sent to the DNS server to update it with changes to the gateway name.

### SUBCOMMANDS

The options for this command are configured and read using the standard `config`, `cget`, and `getOptions` subcommands defined in the `ixConfig` command.

### OPTIONS

`dns_record_time_to_live`

Used for DNS update query to specify time of validity of the updated DNS record. Default = "43,200."

`dns_ip_port`

Hostname:port number or IP address:port number of DNS server to which DNS records will be sent. Default = "192.168.1.1:53."

### EXAMPLE

```
$Activity_MGCPClient1 agent.pm.dns_update_parameters.config \-dns_record_name
"" \-dns_record_address                "" \-dns_record_time_to_live
43200 \-dns_source_ip                   "" \-enable_dns_updates
false \-dns_ip_port                     "192.168.1.1:53"
```

## Endpoint Names

### SYNOPSIS

```
set Traffic1_Network1 [::IxLoad new ixNetTraffic]
set Activity_MGCPClient1 [$Traffic1_Network1 activityList.appendItem options...]
$Activity_MGCPClient1 agent.pm.endpoint_parameters.config
```

### DESCRIPTION

Configures the names used for MGCP endpoints. An MGCP client's endpoint update parameters are set by modifying the options of the `pm.endpoint_parameters` option of the `MGCP Client Agent` object.

### SUBCOMMANDS

None.

### OPTIONS

GatewayName

Gateway IP address:port or domain name:port. (Default = "ixloadmgw.ixia-lab.com").

NumberOfEndpoints

Number of endpoints hosted by the gateway. Minimum = "1," maximum = "15,000." (Default = "2").

UseCustomNames

Specifies whether to use custom names or not. (Default = "0").

EndpointNamePrefix

Prefix applied to endpoint name. (Default = "aaln/").

EndpointNameSuffix

Suffix applied to endpoint name. (Default={}).

EndpointNameStartAt

Initial value of variable portion of endpoint name. Minimum = "0," maximum = "4,294,967,295." (Default = "0").

EndpointNameExpandOn

Width of variable used to create endpoint names that are unique within a gate way. Minimum = "1," maximum = "5." (Default = "1").

EndpointNameStep

Amount of increase in the variable (the Endpoint Name Expand On parameter) used to create unique base endpoint names. Minimum = "1," maximum = "3,000." (Default = "1").

EndpointPhonePrefix

String containing digits to be used at beginning of phone number. (Default = {}).

EndpointPhoneSuffix

String containing digits to be used at the end of the phone number. (Default = {}).

EndpointPhoneStartAt

Initial value of variable portion of phone number. Minimum = "0" Maximum = "4,294,967,295." (Default = "1,000").

EndpointPhoneStep

Amount of increase in variable to create additional phone numbers. Minimum = "1," maximum = "3,000." (Default = "1").

NumGateways

Number of gateways. Minimum = "1," maximum = "3,000." (Default = "2").

GatewayNamePrefix

String prefixed to gateway name. (Default = "ix").

GatewayNameSuffix

String suffixed to gateway name. (Default = ".ixia-lab.com").

GatewayNameStartAt

Initial value of variable portion of gateway name. Minimum = "0," maximum = "4,294,967,295." (Default = "3,000").

GatewayNameExpandOn

Width of variable used to create unique gateway names. Minimum = "1," maximum = "5." (Default = "1").

GatewayNameStep

Amount of increase in variable used for gateway name. Minimum = "1," maximum = "3,000." (Default = "1").

## EXAMPLE

```
$Activity_MGCPClient1 agent.pm.endpoint_parameters.config \-GatewayName
"ixloadmgw.ixia-lab.com" \-NumGateways                2 \-
EndpointPhonePrefix                                "" \-EndpointNameSuffix
"" \-EndpointPhoneStartAt                            1000 \-EndpointNameExpandOn
```

---

```
1 \-GatewayNamePrefix          "ix" \-NumberOfEndpoints
2 \-GatewayNameStep            1 \-EndpointNameStartAt
0 \-EndpointNameStep           1 \-EndpointPhoneStep
1 \-GatewayNameStartAt        3000 \-UseCustomNames
false \-EndpointPhoneSuffix    "" \-EndpointNamePrefix
"aaln/" \-GatewayNameSuffix    ".ixia-lab.com" \-
GatewayNameExpandOn           1
```

**SEE ALSO**

[MGCP Client Agent](#)

## Media Settings

Media Settings—Selects and configures the streaming audio files for the multisession that the client will play over RTP.

### SYNOPSIS

```
set Traffic1_Network1 [::IxLoad new ixNetTraffic]
set Activity_MGCPClient1 [$Traffic1_Network1 activityList.appendItem options...]
$Activity_MGCPClient1 agent.pm.mediaSettings.config
```

### DESCRIPTION

An MGCP client's media settings are set by modifying the options of the `pm.mediaSettings` option of the `MGCP Client Agent` object.

### SUBCOMMANDS

None.

### OPTIONS

`szCodecName`

Codec to be used to encode waveform audio files listed in the Audio Clips Pool. The choices are:

Value	Description
"G711ALaw"	(default) G.711 A-law
"G711ULaw"	G.711 mu-law
"G729A"	G.729A
"G729B"	G.729B
"G726"	G.726
"G723_1"	G.723.1

`szCodecDetails`

Displays the properties of the codec such as the number of bytes per frame of compressed audio, and the rate at which packets are sent over the connection. (Default = {}).

`szCodecDescr`

Codec description. (Default = {}).

`bModifyPowerLevel`

If `true`, `IxLoad` modifies the volume of the compressed audio. (Default = "0").

`szPowerLevel`

If `bModifyPowerLevel` is `true`, this parameter specifies the amount of gain (volume added to compressed audio). The choices are :

Value	Description
"PLO"	(default) 0 dB
"PL_10"	-10 dB
"PL_20"	-20 dB
"PL_30"	-30 dB

`bUseJitter`

Enables or disables use of the jitter buffer. (Default = "0").

`bJitMs`

Defines the method used to set the jitter buffer size.

Value	Description
0	(Default). Jitter buffer size is set by <code>nJitterBuffer</code> .
1	Jitter buffer size is set by <code>nJitterMs</code> .

`nJitterBuffer`

Jitter Buffer size, in packets. Minimum = "1," maximum = "300." (Default = "1").

`nJitterMs`

Jitter Buffer size, in milliseconds. Minimum = "1," maximum = "3,000." (Default = "20").

`bUseCompensation`

Enables or disables use of the compensation jitter buffer. (Default = "0").

`bCompMs`

Defines the method used to set the compensation jitter buffer size.

Value	Description
0	(Default). Compensation jitter buffer size is set by <code>nCompJitterBuffer</code> .
1	Compensation jitter buffer size is set by <code>nCompJitterMs</code> .

`nCompJitterBuffer`

Compensation jitter buffer maximum size, in packets. Minimum = "0," maximum = "300." (Default = "50").

`nCompJitterMs`

Compensation jitter buffer maximum size, in milliseconds. Minimum = "0," maximum = "3,000." (Default = "1,000").

`nCompMaxDropped`

Maximum dropped consecutive packets. Minimum = "1," maximum = "100." (Default = "7").

`bUseMOS`

Enables or disables use of MOS. (Default = "0").

`bMosOnMax`

Defines whether MOS is calculated for a subset of streams or for all streams.

Value	Description
0	(Default). MOS calculation is applied to all streams.
1	MOS calculation is applied to the number of streams specified by <code>nMosMax</code> .

`nMosMaxStreams`

Maximum number of concurrent streams used in MOS calculation. Minimum = "1." (Default = "1").

`nMosInterval`

Frequency at which IxLoad samples the RTP streams to generate the MOS scores. Minimum = "2," maximum = "30." (Default = "3").

`nDtmfDuration`

Length of time allowed to play the DTMF sequence. Minimum = "60," maximum = "999." (Default = "100").

`nDtmfInterdigits`



Duration (in milliseconds) of the DTMF interdigit signal. Minimum = "30," maximum = "9999."  
(Default = "40").

bLimitDtmf

Enable or disable limitation on the number of DTMF streams to be processed. (Default = "1").

Value	Description
0	DTMF applied to all streams.
1	(Default) DTMF limited to number of streams specified by nDtmfStreams.

nDtmfStreams

Number of streams to which path confirmation will be applied. Minimum = "1" maximum = "900."  
(Default = "10").

nPcInterval

If Synthetic path confirmation is selected, this is the interval at which IxLoad add the synthetic RTP packets to the stream. Minimum = "1." (Default = "500").

nSessionType

Type of voice session. The choices are:

Value	Description
"0"	(default) Plays audio file specified by szAudioFile.
"1"	Perform DTMF path confirmation.
"2"	Perform synthetic DTMF path confirmation.

szDtmfSeq

DTMF sequence used for path confirmation. (Default = "12,345").

szPeerCodecName

Name of codec used by peer. (Default = {}).

szPeerCodecDetails

Details of codec used by peer. (Default = {}).

szPeerDtmfSeq

DTMF sequence used by peer. (Default = {}).

nPeerDtmfDuration

DTMF duration used by peer. (Default = "0").

nPeerDtmfInterdigits

Inter-digits interval used by peer. (Default = "0").

audioClipsTable

This is a list of type `Audio Clips Pool`. This list contains the waveform audio files that the MGCP client will play. (Default = {}).

### EXAMPLE

```
$Activity_MGCPClient1 agent.pm.mediaSettings.config \-nPcInterval
500 \-nJitterBuffer 1 \-nDtmfInterdigits
40 \-nCompMaxDropped 7 \-nPeerDtmfDuration
0 \-nJitterMs 20 \-nAudioPoolTime
1181544691 \-nDtmfDuration 100 \-szPeerCodecName
"" \-groupBox_MOS1 false \-szPeerCodecDetails
"" \-bMosOnMax 0 \-groupBox_JB1
false \-nMosInterval 3 \-nCompJitterBuffer
50 \-bUseJitter false \-szCodecName
"G711ALaw" \-szPeerDtmfSeq "" \-bLimitDtmf
true \-bUseMOS false \-bJitMs
0 \-szCodecDescr "ITU-T G.711 is a standard to represent
8 bit compressed pulse code modulation (PCM) samples for signals of voice fre-
quencies, sampled at the rate of 8000 samples/second. G.711 encoder will create a 64
Kbps bitstream. A-Law G.711 PCM encoder converts 13 bit linear PCM samples into 8
bit compressed PCM (logarithmic form) samples, and the decoder does the conversion
vice versa." \-bCompMs 0 \-nDtmfStreams
10 \-szPowerLevel "PL_20" \-szDtmfSeq
"12345" \-nCompJitterMs 1000 \-nPeerDtmfInterdigits
0 \-nMosMaxStreams 1 \-szCodecDetails
"BF160PT20" \-nSessionType 0 \-bModifyPowerLevel
false \-bUseCompensation false
```

### SEE ALSO

[MGCP Client Agent](#)

## Commands

Commands—Creates the list of MGCP commands that the client will send.

### SYNOPSIS

```
set Traffic1_Network1 [::IxLoad new ixNetTraffic]
set Activity_MGCPClient1 [$Traffic1_Network1 activityList.appendItem options...]
$Activity_MGCPClient1 agent.pm.scenarios.appendItem
```

### DESCRIPTION

A command is added to the Scenarios object using the `appendItem` subcommand from the `ixConfigSequenceContainer` command.

### SUBCOMMANDS

The options for this command are configured and read using the standard `config`, `cget`, and `getOption` subcommands defined in the `ixConfig` command.

### OPTIONS

`id`

MGCP command to be executed. One of the following:

Command	Description
OriginateCall	Sets up a multimedia session with the specified destination.
THINK	Pause during command list processing. You should include a {Think} command whenever necessary to allow the destination to process the preceding commands. You can configure a pause of fixed length or of random length.
EndCall	Terminates the MGCP session.
ReceiveCall	Accepts a call from another endpoint.
VOICESESSION	Plays one of the waveform audio files listed in the Audio Clips Pool on the Media Settings tab. The MGCP client sends the file to the destination configured for the previous Originate Call command in the command list.

### Arguments for `id = OriginateCall`

Destination

Destination of the call, which is usually another endpoint. If the destination is an IxLoad MGCP server agent, specify the name of the agent. (Default = "99,312,345").

### Arguments for id = THINK

MinDuration

Minimum length of the pause, in milliseconds. To configure a fixed-length pause, enter the same value in this field and MaxDuration. (Default = "1").

MaxDuration

Maximum length of the pause, in milliseconds. To configure a fixed-length pause, enter the same value in this field and MinDuration. (Default = "1").

### Arguments for id = ReceiveCall

RSpeakSequenceFile

File containing media description. (Default = "mgcp\_speak\_config").

### Arguments for id = VOICESESSION

szAudioFile

Waveform audio file that will be played during the session. This must be an `szWaveName` object contained within the `Audio Clips Pool` object. (Default = "<None>").

nPlayMode

If `true`, the audio file plays for a fixed number of times. If `false`, the audio file plays continuously. (Default = "0").

nRepeatCount

If `nPlayMode` is `true`, this parameter sets the number of times that the audio file will play. (Default = "1").

nPlayTime

Length of time to play the audio file. Specify the units of time in the `nTimeUnit`.

nTimeUnit

Units of time used to set the audio file play time (`nPlayTime`). The choices are:

Value	Description
"0"	(default) Seconds

"1"	Minutes
"2"	Hours
"3"	Days

nTotalTime

(Read-only). Total length of time that the audio file will be played.

nSessionType

Type of voice session. The choices are:

Value	Description
"0"	(default) Plays audio file specified by szAudioFile.
"1"	Perform DTMF path confirmation.
"2"	Perform synthetic DTMF path confirmation.

nWavDuration

(Read-only). Length of selected audio (.wav) file.

szDtmfSeq

For a path confirmation Voice Session, (nSessionType = 1 or 2), this is the DTMF sequence.  
(Default = "12345").

### EXAMPLE

```
$Activity_MGCPClient1 agent.pm.scenarios.appendItem \-id
"OriginateCall" \-Destination "99312345"$Activity_
MGCPClient1 agent.pm.scenarios.appendItem \-id
"ReceiveCall" \-RSpeakSequenceFile "mgcp_speak_config"$Activ-
ity_MGCPClient1 agent.pm.scenarios.appendItem \-id
"EndCall" \-Dummy 1
```

### SEE ALSO

[MGCP Client Agent](#)

## Custom Endpoint Names

### SYNOPSIS

```
set Traffic1_Network1 [::IxLoad new ixNetTraffic]
set Activity_MGCPClient1 [$Traffic1_Network1 activityList.appendItem options...]
$Activity_MGCPClient1 agent.pm.customNamesList.endpoint_names.config
```

### DESCRIPTION

Retrieves the list of custom endpoint names generated by `Endpoint Names`.

### SUBCOMMANDS

None.

### SUB-OBJECTS

`endpoint_names`

List of custom endpoint names to be used. This is a list of `Custom Name` objects, which have the following format:

Value	Description
<code>endpoint_name</code>	Endpoint name. <code>Default={}</code> .
<code>destination_number</code>	Phone number of endpoint. <code>Default={}</code> .

### EXAMPLE

```
$Activity_MGCPClient1 agent.pm.custom\  
endpoint_names
```

### SEE ALSO

[Endpoint Names](#)

## MGCP Server Agent

MGCP Server Agent - create an MGCP server

### SYNOPSIS

```
set Traffic2_Network2 [::IxLoad new ixNetTraffic]
set Activity_MGCPServer1 [$Traffic2_Network2 activityList.appendItem options...]
$Activity_MGCPServer1 agent.config
```

### DESCRIPTION

An MGCP server agent is added to the `activityList` object. The `activityList` object is added to the `ixNetTraffic` object using the `appendItem` subcommand from the `ixConfigSequenceContainer` command.

### SUBCOMMANDS

The options for this command are configured and read using the standard `config`, `cget`, and `getOption` subcommands defined in the `ixConfig` command.

### OPTIONS

`enable`

Enables the use of this client agent. (Default = true).

`name`

The name associated with this object, which must be set at object creation time.

### STATISTICS

#### EXAMPLE

```
set Traffic2_Network2 [::IxLoad new
ixNetTraffic]##### Activity MGCPServer1
of NetTraffic Traffic2@Network2#####set
Activity_MGCPServer1 [$Traffic2_Network2 activityList.appendItem \-protocolAndType
"MGCP Server" ]$Activity_MGCPServer1 agent.config \-enable
true \-name "MGCPServer1"
```

### SEE ALSO

[ixNetTraffic](#)

## Parameters

### SYNOPSIS

```
set Traffic2_Network2 [::IxLoad new ixNetTraffic]
set Activity_MGCPServer1 [$Traffic2_Network2 activityList.appendItem options...]
$Activity_MGCPServer1 agent.pm.parameters.config
```

### DESCRIPTION

An MGCP server's basic parameters are set by modifying the options of the `pm.parameters` option of the `MGCP Server Agent` object.

### SUBCOMMANDS

The options for this command are configured and read using the standard `config`, `cget`, and `getOption` subcommands defined in the `ixConfig` command.

### OPTIONS

`call_agent_name`

Call agent FQDN name that controls this gateway. (Default = "prica.ixi")

`listen_port_start`

Initial port that the agent listens on for new MGCP connections. Minimum = "1" maximum = "65,535." (Default = "2,727").

`listen_port_step`

Increment value applied initially to `listen_port_start` and to each subsequent value to create the list of listening ports. Minimum = "1." (Default = "1").

`enableTosMGCP`

Enable TOS for MGCP traffic.

Value	Description
0	(default) TOS bits not enabled.
1	TOS bits enabled.

`type_of_service_for_mgcp`

If `enableTosMGCP` is `true`, this option specifies the IP Precedence / TOS (Type of Service) bit setting and Assured Forwarding classes. (Default = "Best Effort 0x0"). If you want to specify the stand-



ard choices that are in the GUI, you can use a string representation. To specify any of the other 255 TOS values, specify the decimal value. The default choices are:

Value	Description
"Best Effort (0x0)"	(Default) routine priority
"Class 1 (0x20)"	Priority service, Assured Forwarding class 1
"Class 2 (0x40)"	Immediate service, Assured Forwarding class 2
"Class 3 (0x60)"	Flash, Assured Forwarding class 3
"Class 4 (0x80)"	Flash-override, Assured Forwarding class 4
"Express Forwarding (0xA0)"	Critical-ecp
"Control (0xC0)"	Internet-control

### EXAMPLE

```
$Activity_MGCPServer1 agent.pm.parameters.config \-listen_port_stop
1 \-type_of_service_for_mgcp "Best Effort (0x0)" \-listen_port_start
2727 \-call_agent_name "prica.ixia-lab.com" \-enableTosMGCP
true \-listen_port_step 1
```

### SEE ALSO

[MGCP Server Agent](#)

## Low Level Parameters

### SYNOPSIS

```
set Traffic2_Network2 [::IxLoad new ixNetTraffic]
set Activity_MGCPServer1 [$Traffic2_Network2 activityList.appendItem options...]
$Activity_MGCPServer1 agent.pm.ll_parameters.config
```

### DESCRIPTION

An MGCP server's low-level parameters are set by modifying the options of the `pm.ll_parameters` option of the `MGCP Server Agent` object.

### SUBCOMMANDS

None.

### OPTIONS

`CommandTimeout`

If no response to a command is received within this number of seconds, a error is declared. Minimum = "1," maximum = "120." (Default = "30").

`AcknowledgeResponses`

Specifies if the sent command will include the K parameter with the ID of last received response. (Default = "0").

### EXAMPLE

```
$Activity_MGCPServer1 agent.pm.ll_parameters.config \-CommandTimeout
30 \-AcknowledgeResponses true
```

### SEE ALSO

[MGCP Server Agent](#)

## DNS Updates

### SYNOPSIS

```
set Traffic2_Network2 [::IxLoad new ixNetTraffic]
set Activity_MGCPServer1 [$Traffic2_Network2 activityList.appendItem options...]
$Activity_MGCPServer1 agent.pm.dns_update_parameters.config
```

### DESCRIPTION

An MGCP server's DNS update parameters are set by modifying the options of the `pm.dns_update_parameters` option of the MGCP Server Agent object.

### SUBCOMMANDS

None.

### OPTIONS

`enable_dns_updates`

Updates a DNS server with updates to the gateway names. The DNS server must be configured to accept Update Queries from the IxLoad IP address. The first IP in range will be used to source the DNS Query packets. (Default = "0").

`dns_records`

List of DNS records to be sent to the DNS servers. This is a list of `DNS Record` objects.

`dns_record_name`

Name to be added to DNS database. (Default = {}).

`dns_record_address`

IP address to be added to DNS database. (Default = {}).

`dns_record_time_to_live`

Used for DNS update query to specify time of validity of the updated DNS record. (Default = "43,200").

`dns_source_ip`

IP address indicated as the source of the DNS records. (Default = {}).

`dns_ip_port`

Hostname:port number or IP address:port number of DNS server to which DNS records will be sent. (Default = "192.168.1.1:53").

### EXAMPLE

```
$Activity_MGCPServer1 agent.pm.dns_update_parameters.config \-dns_record_name
```

```
"" \-dns_record_address  
43200 \-dns_source_ip  
false \-dns_ip_port
```

```
"" \-dns_record_time_to_live  
"" \-enable_dns_updates  
"192.168.1.1:53"
```

### **SEE ALSO**

[MGCP Server Agent](#)

[DNS Record](#)

## DNS Record

### SYNOPSIS

```
set Traffic2_Network2 [::IxLoad new ixNetTraffic]
set Activity_MGCPServer1 [$Traffic2_Network2 activityList.appendItem options...]
$Activity_MGCPServer1 agent.pm.dnsrecord.config
```

### DESCRIPTION

The `DnsRecord` command is used to add DNS records to the list of records that will be sent to the DNS server to update it with changes to the gateway name.

The complete list of records is contained in the `dns_records` option of the `DNS Updates` object.

### SUBCOMMANDS

The options for this command are configured and read using the standard `config`, `cget`, and `getOption` subcommands defined in the `ixConfig` command.

### OPTIONS

`dns_record_name`

Name to be added to DNS database. (Default = {}).

`dns_record_address`

IP address to be added to DNS database. (Default = {}).

### EXAMPLE

```
$Activity_MGCPServer1 agent.pm.dns_update_parameters.config \-dns_record_name
"" \-dns_record_address                "" \-dns_record_time_to_live
43200 \-dns_source_ip                  "" \-enable_dns_updates
false \-dns_ip_port                    "192.168.1.1:53"
```

### SEE ALSO

[DNS Updates](#)

## Endpoint Names

### SYNOPSIS

```
set Traffic2_Network2 [::IxLoad new ixNetTraffic]
set Activity_MGCPServer1 [$Traffic2_Network2 activityList.appendItem options...]
$Activity_MGCPServer1 agent.pm.endpoint_parameters.config
```

### DESCRIPTION

Configures the names used for MGCP endpoints. An MGCP client's endpoint parameters are set by modifying the options of the `pm.endpoint_parameters` option of the MGCP Server Agent object.

### SUBCOMMANDS

None.

### OPTIONS

NumberOfEndpoints

Number of endpoints hosted by the gateway. Minimum = "1," maximum = "15,000." (Default = "2").

UseCustomNames

Specifies whether to use custom names or not. (Default = "0").

EndpointNamePrefix

Prefix applied to endpoint name. (Default = "aaln/").

EndpointNameSuffix

Suffix applied to endpoint name. (Default = {}).

EndpointNameStartAt

Initial value of variable portion of endpoint name. Minimum = "0," maximum = "4,294,967,295." (Default = "0").

EndpointNameExpand

On

Width of variable used to create endpoint names that are unique within a gate way. Minimum = "1," maximum = "5." (Default = "1").

EndpointNameStep

Amount of increase in the variable (the Endpoint Name Expand On parameter) used to create unique base endpoint names. Minimum = "1," maximum = "3,000." (Default = "1").

EndpointPhonePrefix

String containing digits to be used at beginning of phone number. (Default = {}).

EndpointPhoneSuffix

String containing digits to be used at the end of the phone number. (Default = {}).

EndpointPhoneStartAt

Initial value of variable portion of phone number. Minimum = "0," maximum = "4,294,967,295." (Default = "1,000").

EndpointPhoneStep

Amount of increase in variable to create additional phone numbers. Minimum = "1," maximum = "3000." (Default = "1").

NumGateways

Number of gateways. Minimum = "1," maximum = "3,000." (Default = "2").

GatewayNamePrefix

String prefixed to gateway name. (Default = "ix").

GatewayNameSuffix

String suffixed to gateway name. (Default = ".ixia-lab.com").

GatewayNameStartAt

Initial value of variable portion of gateway name. Minimum = "0," maximum = "4,294,967,295." (Default = "3,000").

GatewayNameExpand

On

Width of variable used to create unique gateway names. Minimum = "1," maximum = "5," (Default = "1").

GatewayNameStep

Amount of increase in variable used for gateway name. Minimum = "1," maximum = "3,000." (Default = "1").

## EXAMPLE

```
$Activity_MGCPServer1 agent.pm.endpoint_parameters.config \-NumGateways
4 \-EndpointPhonePrefix          "" \-EndpointNameSuffix
"" \-EndpointPhoneStartAt        1000 \-EndpointNameExpandOn
1 \-GatewayNamePrefix           "ix" \-NumberOfEndpoints
2 \-GatewayNameStep              1 \-EndpointNameStartAt
0 \-EndpointNameStep             1 \-EndpointPhoneStep
1 \-GatewayNameStartAt          3000 \-UseCustomNames
false \-EndpointPhoneSuffix      "" \-EndpointNamePrefix
```

```
"aaln/" \-GatewayNameSuffix  
GatewayNameExpandOn 1 ".ixia-lab.com" \-
```

### **SEE ALSO**

[MGCP Server Agent](#)



## Custom Endpoint Names

### SYNOPSIS

```
set Traffic2_Network2 [::IxLoad new ixNetTraffic]
set Activity_MGCPServer1 [$Traffic2_Network2 activityList.appendItem options...]
$set Activity_MGCPServer1 agentList(0).pm.customNamesList \
endpoint_names
```

### DESCRIPTION

Retrieves the list of custom endpoint names generated by `Endpoint Names`.

### SUBCOMMANDS

None.

### OPTIONS

`endpoint_names`

List of custom endpoint names to be used. This is a list of `Custom Name` objects, which have the following format:

Value	Description
<code>endpoint_name</code>	Endpoint name. Default={}
<code>destination_number</code>	Phone number of endpoint. Default={}

### EXAMPLE

```
$set Activity_MGCPServer1 agentList(0).pm.customNamesList\
endpoint_names
```

### SEE ALSO

[Endpoint Names](#)

## **Bulk MGCP Statistics**

For Bulk MGCP statistics, see the following:

[Bulk MGCP Client Statistics](#)

[Bulk MGCP Server Statistics](#)

## Bulk MGCP Client Statistics

The following table describes the Bulk MGCP Client statistics.

Statistic	Description
<b>Objectives Statistics</b>	
MGCP Simulated Users	Number of MGCP users simulated during the test.
MGCP connections initiated	Number of MGCP connections initiated during the test.
MGCP connections completed	Number of MGCP connections successfully completed during the test.
MGCP connections active	Number of MGCP connections active.
MGCP connections failed busy	Number of MGCP connections that failed because they received a Busy tone.
MGCP connections failed reorder	Number of initiated MGCP connections that failed because they received a Reorder tone.
<b>Total Message Statistics</b>	
Total MGCP Messages Sent	Total number of MGCP messages sent by the client.
Total MGCP Messages Received	Total number of MGCP messages received by the client.
Total MGCP Messages Malformed	Total number of malformed MGCP messages received by the client.
<b>NTFY messages</b>	
NTFY sent	Number of NTFY (Notify) messages sent by the client.
NTFY recv	Number of NTFY (Notify) messages received by the client.
NTFY success	Number of NTFY (Notify) messages sent by the client that succeeded.
NTFY failed	Number of NTFY (Notify) messages sent by the client that failed.

NTFY dial sent	Number of NTFY (Notify) dialing messages sent by the client.
NTFY dial recv	Number of NTFY (Notify) dialing messages received by the client.
NTFY dial success	Number of NTFY (Notify) dialing messages sent by the client that succeeded.
NTFY dial failed	Number of NTFY (Notify) dialing messages sent by the client that failed.
<b>CRCX messages</b>	
CRCX sent	Number of CRCX (Create Connection) messages sent by the client.
CRCX recv	Number of CRCX (Create Connection) messages received by the client.
CRCX success	Number of CRCX (Create Connection) messages sent by the client that succeeded.
CRCX failed	Number of CRCX (Create Connection) messages sent by the client that failed.
<b>MDCX messages</b>	
MDCX sent	Number of MDCX (Modify Connection) messages sent by the client.
MDCX recv	Number of MDCX (Modify Connection) messages received by the client.
MDCX success	Number of MDCX (Modify Connection) messages sent by the client that succeeded.
MDCX failed	Number of MDCX (Modify Connection) messages sent by the client that failed.
<b>DLCX messages</b>	
DLCX sent	Number of DLCX (Delete Connection) messages sent by the client.
DLCX recv	Number of DLCX (Delete Connection) messages received by the client.

DLCX success	Number of DLCX (Delete Connection) messages sent by the client that succeeded.
DLCX failed	Number of DLCX (Delete Connection) messages sent by the client that failed.
<b>RQNT messages</b>	
RQNT sent	Number of RQNT (Notification Request) messages sent by the client.
RQNT rcv	Number of RQNT (Notification Request) messages received by the client.
RQNT success	Number of RQNT (Notification Request) messages sent by the client that succeeded.
RQNT failed	Number of RQNT (Notification Request) messages sent by the client that failed.
<b>AUEP messages</b>	
AUEP sent	Number of AUEP (Audit Endpoint) messages sent by the client.
AUEP rcv	Number of AUEP (Audit Endpoint) messages received by the client.
AUEP success	Number of AUEP (Audit Endpoint) messages sent by the client that succeeded.
AUEP failed	Number of AUEP (Audit Endpoint) messages sent by the client that failed.
<b>AUCX messages</b>	
AUCX sent	Number of AUCX (Audit Connection) messages sent by the client.
AUCX rcv	Number of AUCX (Audit Connection) messages received by the client.
AUCX success	Number of AUCX (Audit Connection) messages sent by the client that succeeded.
AUCX failed	Number of AUCX (Audit Connection) messages sent by the client that failed.

<b>EPCF messages</b>	
EPCF sent	Number of EPCF (Endpoint Configuration) messages sent by the client.
EPCF rcv	Number of EPCF (Endpoint Configuration) messages received by the client.
EPCF success	Number of EPCF (Endpoint Configuration) messages sent by the client that succeeded.
EPCF failed	Number of EPCF (Endpoint Configuration) messages sent by the client that failed.
<b>RSIP messages</b>	
RSIP sent	Number of RSIP (Restart in Progress) messages sent by the client.
RSIP rcv	Number of RSIP (Restart in Progress) messages received by the client.
RSIP success	Number of RSIP (Restart in Progress) messages sent by the client that succeeded.
RSIP failed	Number of RSIP (Restart in Progress) messages sent by the client that failed.
<b>1XX Responses</b>	
Responses_1XX sent	Number of 100-series responses sent by the client. 100-series responses indicate provisional responses.
Responses_1XX rcv	Number of 100-series responses received by the client.
<b>2XX Responses</b>	
Responses_2XX sent	Number of 200-series responses sent by the client. 200-series responses indicate successful completion.
Responses_2XX rcv	Number of 200-series responses received by the client.
<b>XX Responses</b>	

Responses_3XX sent	Number of 300-series responses sent by the client.
Responses_3XX rcv	Number of 300-series responses received by the client.
<b>4XX Responses</b>	
Responses_4XX sent	Number of 400-series responses sent by the client. 400-series responses indicate a transient error.
Responses_4XX rcv	Number of 400-series responses received by the client.
<b>5XX Responses</b>	
Responses_5XX sent	Number of 500-series responses sent by the client. 500-series responses indicate a permanent error.
Responses_5XX rcv	Number of 500-series responses received by the client.
<b>RTP: Global Stream Transmit Statistics</b>	
RTP Bytes Sent	Total number of bytes sent, including header and payload.
RTP Packets Sent	Total number of packets sent.
RTP Tx Jitter (ns)	Average amount of transmit jitter, in nanoseconds.
RTP Tx Packets Dropped	Number of packets transmitted by the client that were dropped.
<b>RTP: Global Stream Statistics</b>	
RTP Dropped Packets	Number of RTP packets dropped.
RTP Bytes Received	Number of RTP bytes received.
RTP Packets Received	Number of RTP packets received.
RTP Payload Bytes Received	Number bytes received in RTP payloads.
RTP Bad Packets Received	Number of defective RTP packets received.
RTP Lost Packets	Number of packets lost.
RTP Misordered Packets Received	Number of packets received out of order.

RTP Duplicate Packets Received	Number of duplicate packets received.
RTP Jitter Min	Smallest amount of jitter detected.
RTP Jitter Max	Largest amount of jitter detected.
RTP Packets With Jitter Up To 1ms	Packets received with jitter of up to 1ms.
RTP Packets With Jitter Up To 3ms	Packets received with jitter of 1-3ms.
RTP Packets With Jitter Up To 5ms	Packets received with jitter of 3-5ms.
RTP Packets With Jitter Up To 10ms	Packets received with jitter of 5-10ms.
RTP Packets With Jitter Up To 20ms	Packets received with jitter of 10-20ms
RTP Packets With Jitter Up To 40ms	Packets received with jitter of 20-40ms
RTP Packets With Jitter More Than 40ms	Packets received with jitter of more than 40ms.
RTP DTMFs Detected	Total number of path confirmation DTMF tone sequences sent.
RTP Good DTMF Sequences Detected	Total number of correct path confirmation DTMF tone sequences received.
RTP Bad DTMF Sequences Detected	Total number of incorrect path confirmation DTMF tone sequences received.
RTP Packets Dropped By Jitter Buffer	Number of packet dropped from the jitter buffer because they arrived later than expected.
<b>Note:</b> In the CSV files, global MOS scores are represented as whole numbers (for example, "345"); in StatViewer (they are represented as floating-point numbers (for example, "3.45").	
RTP MOS Average Instant	Average MOS score at the time of the sampling interval.
RTP MOS Worst Instant	Lowest MOS score at the time of the sampling interval.
RTP MOS Best Instant	Highest MOS score at the time of the sampling interval.
RTP MOS Worst	Lowest MOS score recorded during the test.
RTP MOS Best	Highest MOS score recorded during the test.



RTP MOS Average Per Call	Average MOS score per call.
RTP MOS Worst Per Call	Lowest MOS score per call.
RTP MOS Best Per Call	Highest MOS score per call.
RTP Calls With Continuous Path Confirmation	Number of calls on which path confirmation continued throughout the call.
RTP Calls With Interrupted Path Confirmation	Number of calls on which path confirmation was interrupted during the call.
RTP Calls Without Path Confirmation	Number of calls on which there was no path confirmation.
<b>Transport Statistics</b>	
MGCP Bytes Transmitted	Number of MGCP bytes transmitted.
MGCP Bytes Received	Number of MGCP bytes received.
MGCP Signaling UDP Packets Transmitted	Number of UDP packets containing MGCP signaling bytes transmitted.
MGCP Signaling UDP Packets Received	Number of UDP packets containing MGCP signaling bytes received.
<b>Per-Stream Statistics</b>	
RTP Path Confirmation Status	Status of path confirmation on the stream. Note for Tcl API users: For this statistic, use the Aggregation Type <i>kString</i> .
RTP MOS	Average MOS score recorded on the stream.
RTP Worst MOS	Lowest MOS score recorded on the stream.
RTP Best MOS	Highest MOS score recorded on the stream.
RTP Bytes	Number of bytes transmitted on the stream.
RTP Packets	Number of packets transmitted on the stream.
RTP Bad Packets	Number of bad packets transmitted on the stream.
RTP Lost Packets	Number of packets lost on the stream.

RTP Missorder Packets	Number of packets received out of order on the stream.
RTP Duplicate Packets	Number of duplicate packets received on the stream.
RTP Packets With Jitter Up To 1ms	Number of packets received on the stream with jitter up to 1 millisecond.
RTP Packets With Jitter Up To 3ms	Number of packets received on the stream with jitter up to 3 milliseconds.
RTP Packets With Jitter Up To 5ms	Number of packets received on the stream with jitter up to 5 milliseconds.
RTP Packets With Jitter Up To 10ms	Number of packets received on the stream with jitter up to 10 milliseconds.
RTP Packets With Jitter Up To 20ms	Number of packets received on the stream with jitter up to 20 milliseconds.
RTP Packets With Jitter Up To 40ms	Number of packets received on the stream with jitter up to 40 milliseconds.
RTP Packets With Jitter More Than 40ms	Number of packets received on the stream with jitter over 40 milliseconds.
RTP Average Jitter (ns)	Average jitter, in nanoseconds.
RTP Min Jitter (ns)	Lowest jitter recorded, in nanoseconds.
RTP Max Jitter (ns)	Largest jitter recorded, in nanoseconds.
RTP DTMFs Detected	Total number of path confirmation DTMF tone sequences sent.
RTP Good DTMF Sequences Detected	Total number of correct path confirmation DTMF tone sequences received.
RTP Bad DTMF Sequences Detected	Total number of incorrect path confirmation DTMF tone sequences received.
RTP Packets Dropped By Jitter Buffer	Total number of packets dropped from the jitter buffer because they were received late.



## Bulk MGCP Server Statistics

The following table describes the Bulk MGCP Server statistics.

Statistic	Description
Total MGCP Commands Received	Total number of MGCP commands received by the server
Total MGCP Responses Received	Total number of MGCP responses received by the server.
Total MGCP Commands Sent	Total number of MGCP commands sent by the server.
Total MGCP Responses Sent	Total number of MGCP responses sent by the server.
Total MGCP Received Malformed Messages	Total number of malformed MGCP messages received by the server.
<b>NTFY messages</b>	
NTFY sent	Number of NTFY (Notify) messages sent by the server.
NTFY rcv	Number of NTFY (Notify) messages received by the server.
NTFY success	Number of NTFY (Notify) messages sent by the server that succeeded.
NTFY failed	Number of NTFY (Notify) messages sent by the server that failed.
NTFY dial sent	Number of NTFY (Notify) dialing messages sent by the server.
NTFY dial rcv	Number of NTFY (Notify) dialing messages received by the server.
NTFY dial success	Number of NTFY (Notify) dialing messages sent by the server that succeeded.
NTFY dial failed	Number of NTFY (Notify) dialing messages sent by the server that failed.
<b>CRCX messages</b>	
CRCX sent	Number of CRCX (Create Connection) messages sent by the server.
CRCX rcv	Number of CRCX (Create Connection) messages received by the server.

CRCX success	Number of CRCX (Create Connection) messages sent by the server that succeeded.
CRCX failed	Number of CRCX (Create Connection) messages sent by the server that failed.
<b>MDCX messages</b>	
MDCX sent	Number of MDCX (Modify Connection) messages sent by the server.
MDCX rcv	Number of MDCX (Modify Connection) messages received by the server.
MDCX success	Number of MDCX (Modify Connection) messages sent by the server that succeeded.
MDCX failed	Number of MDCX (Modify Connection) messages sent by the server that failed.
<b>DLCX messages</b>	
DLCX sent	Number of DLCX (Delete Connection) messages sent by the server.
DLCX rcv	Number of DLCX (Delete Connection) messages received by the server.
DLCX success	Number of DLCX (Delete Connection) messages sent by the server that succeeded.
DLCX failed	Number of DLCX (Delete Connection) messages sent by the server that failed.
<b>RQNT messages</b>	
RQNT sent	Number of RQNT (Notification Request) messages sent by the server.
RQNT rcv	Number of RQNT (Notification Request) messages received by the server.
RQNT success	Number of RQNT (Notification Request) messages sent by the server that succeeded.
RQNT failed	Number of RQNT (Notification Request) messages sent by the server that failed.
<b>AUEP messages</b>	
AUEP sent	Number of AUEP (Audit Endpoint) messages sent by the server.

AUEP recv	Number of AUEP (Audit Endpoint) messages received by the server.
AUEP success	Number of AUEP (Audit Endpoint) messages sent by the server that succeeded.
AUEP failed	Number of AUEP (Audit Endpoint) messages sent by the server that failed.
<b>AUCX messages</b>	
AUCX sent	Number of AUCX (Audit Connection) messages sent by the server.
AUCX recv	Number of AUCX (Audit Connection) messages received by the server.
AUCX success	Number of AUCX (Audit Connection) messages sent by the server that succeeded.
AUCX failed	Number of AUCX (Audit Connection) messages sent by the server that failed.
<b>EPCF messages</b>	
EPCF sent	Number of EPCF (Endpoint Configuration) messages sent by the server.
EPCF recv	Number of EPCF (Endpoint Configuration) messages received by the server.
EPCF success	Number of EPCF (Endpoint Configuration) messages sent by the server that succeeded.
EPCF failed	Number of EPCF (Endpoint Configuration) messages sent by the server that failed.
<b>RSIP messages</b>	
RSIP sent	Number of RSIP (Restart in Progress) messages sent by the server.
RSIP recv	Number of RSIP (Restart in Progress) messages received by the server.
RSIP success	Number of RSIP (Restart in Progress) messages sent by the server that succeeded.
RSIP failed	Number of RSIP (Restart in Progress) messages sent by the server that failed.
<b>1XX Responses</b>	

Responses_1XX sent	Number of 100-series responses sent by the server. 100-series responses indicate provisional responses.
Responses_1XX rcv	Number of 100-series responses received by the server.
<b>2XX Responses</b>	
Responses_2XX sent	Number of 200-series responses sent by the server. 200-series responses indicate successful completion.
Responses_2XX rcv	Number of 200-series responses received by the server.
<b>3XX Responses</b>	
Responses_3XX sent	Number of 300-series responses sent by the server.
Responses_3XX rcv	Number of 300-series responses received by the server.
<b>4XX Responses</b>	
Responses_4XX sent	Number of 400-series responses sent by the server. 400-series responses indicate a transient error.
Responses_4XX rcv	Number of 400-series responses received by the server.
<b>5XX Responses</b>	
Responses_5XX sent	Number of 500-series responses sent by the server. 500-series responses indicate a permanent error.
Responses_5XX rcv	Number of 500-series responses received by the server.
<b>Transport Statistics</b>	
MGCP Signaling Bytes Transmitted	Number of MGCP signaling bytes transmitted.
MGCP Signaling Bytes Received	Number of MGCP signaling bytes received.
MGCP Signaling UDP Packets Transmitted	Number of UDP packets containing MGCP signaling bytes transmitted.
MGCP Signaling UDP Packets Received	Number of UDP packets containing MGCP signaling bytes received.
<b>Objectives Statistics</b>	

MGCP Simulated Users	Number of MGCP users simulated during the test.
MGCP connections initiated	Number of MGCP connections initiated during the test.
MGCP connections completed	Number of MGCP connections successfully completed during the test.
MGCP connections active	Number of MGCP connections active.
MGCP connections failed busy	Number of MGCP connections that failed because they received a Busy tone.
MGCP connections failed reorder	Number of initiated MGCP connections that failed because they received a Reorder tone.



# Bulk SIP

This section describes the SIP Tcl API objects.

## Overview

The IxLoad SIP API consists of a client agent, a server agent, and their com

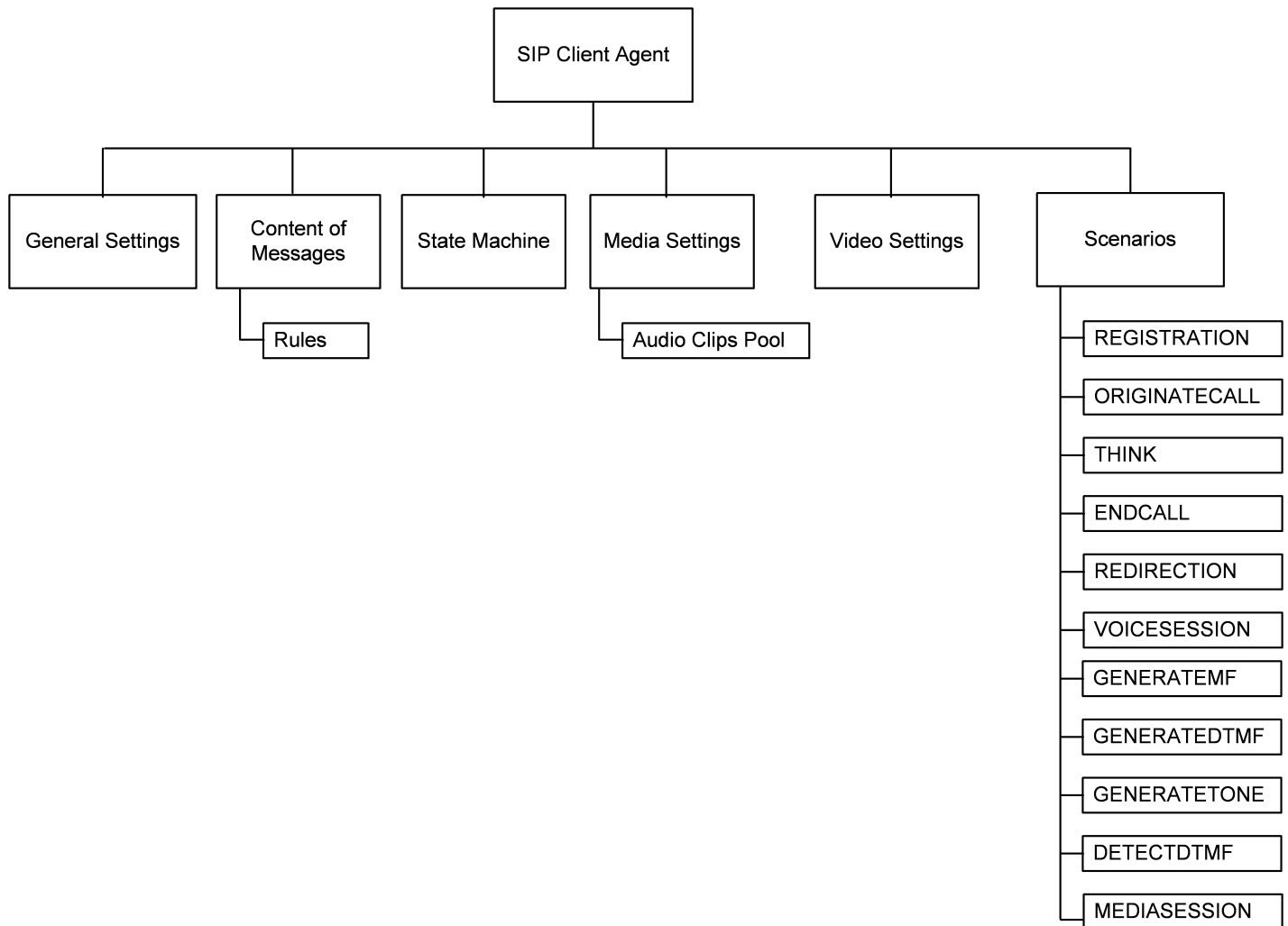

## Objectives

The objectives (userObjective) you can set for SIP are listed below. Test objectives are set in the ixTimeline object.

- simulatedUsers
- useragents
- transactionRate
- bhca
- callsPerSec (displays as "Calls Initiated Per Second" in the GUI)
- registrationsinitiated (displays as "Registrations Initiated Per Second" in the GUI)
- redirectionsinitiated (displays as "Redirections Initiated Per Second" in the GUI)

## SIP Client Commands

This section describes the SIP client Tcl API objects.

## SIP Client Agent

The SIP Client Agent command defines a simulated user using SIP to establish and terminate sessions SIP. Refer to `SIP Client Agent` for a full description of this command. The most significant options of this command are listed below.

Option	Description
enable	Enables the use of this client agent.
name	The name associated with this object, which must be set at object creation time .
protocol	Protocol used by the client agent.
type	Defines the agent as either a client or server.

## General Settings

The SIP Client Agent General Settings command sets the SIP client agent's genconfiguration options. Refer to `General Settings` for a full description of this command. The most significant options of this command are listed below.

Option	Description
szAuthUsername	User name to be registered with registrar.
szAuthPassword	Password to be registered with registrar.
szAuthDomain	Domain to be registered with registrar.
szTransport	Type of transport to be used.
nUdpPort	Port number to be used for sending and receiving SIP mesover UDP.
nTcpPort	Port number to be used for sending and receiving SIP mesover TCP.
nUdpMaxSize	Maximum size, in Kb, of a SIP message that will be sent.
szRegistrar	Host name or IP address and port number of registrar.
bRegBefore	If <code>true</code> , before starting the Originate Call/EnCall --> Receive call process, the IxLoad SIP client registers with the proxy server.
enableTosSIP	Enables the setting of the TOS (Type of Service) bits in the header of the SIP packets.
enableTosRtp	Enables the setting of the TOS (Type of Service) bits in the header of the RTP data packets.
type_of_service_for_sip	IP Precedence / TOS (Type of Service) bit setting and Assured Forwarding classes for the SIP packets.
type_of_service_for_rtp	IP Precedence / TOS (Type of Service) bit setting and Assured Forwarding classes for RTP data packets.

## Content of Messages

The SIP Client Agent Content of Messages command specifies the content of the SIP messages sent by the client. Refer to `Content of Messages` for a full description of this command. The most significant options of this command are listed below.

Option	Description
<code>bRoute</code>	If <code>true</code> , IxLoad inserts a Route header field into the SIP mes
<code>szRoute</code>	If <code>bRoute</code> is <code>true</code> , this parameter specifies the Route header field used to force the request to follow a fixed route through a listed set of proxies.
<code>bCompact</code>	If <code>true</code> , IxLoad uses the compact forms of the SIP header field notations.
<code>bFolding</code>	If <code>true</code> , the VIA field spans two lines. Some SIP devices may not be able to handle this.
<code>bScattered</code>	If <code>true</code> , IxLoad moves the header fields around in the message order to make it more difficult for the DUT to decode the message.
<code>bAdvisable</code>	If <code>true</code> , the SIP request includes the header fields that are defined as 'mandatory' by the SIP RFC (RFC 3261), plus those that are recommended as 'advisable.'
<code>bOptional</code>	If <code>true</code> , the SIP request includes the header fields that are defined as 'mandatory' by the SIP RFC (RFC 3261), plus those that are listed as 'optional.'
<code>bBestPerformance</code>	If <code>true</code> , IxLoad inserts the headers into the message so that the message can be processed as quickly as possible by the receiving system.
<code>szREQUESTURI</code>	User or service to which the SIP request is being addressed.
<code>szFROM</code>	Initiator of the SIP request.
<code>szTO</code>	Logical recipient of the request.
<code>szCONTACT</code>	Contact header field.
<code>rulesTable</code>	Rules defining how this message will be handled.

## Rules

The SIP Client Agent Rules command defines a rule for handling a SIP message. Refer to Rules for a full description of this command. The most significant options of this command are listed below.

Option	Description
szMessage	Type of message the rule will apply to.
szAction	Action that rule performs.
szValue	Numerical value for the <code>szAction</code> .

## State Machine

The SIP Client Agent State Machine command configures the SIP client agent's internal timers and other parameters of its state machine. Refer to `State Machine` for a full description of this command. The most significant options of this comare listed below.

Option	Description
nTimersT1	Estimate of the round-trip time (RTT).
nTimersT2	Maximum retransmit interval, in milliseconds (ms), for non-INVITE requests and INVITE responses.
nTimersT4	Maximum length of time, in milliseconds (ms), that a message will remain in the network.
nTimersTC	Proxy INVITE transaction timeout.
nTimersTD	Wait time for response retransmits.
bUseTimer	If <code>true</code> , IxLoad enforces a timeout limit on transactions.
nTimeout	Transaction timeout interval.
bRecv5xx	If <code>true</code> and IxLoad receives a 5xx series response to a transaction, IxLoad marks it as a failed transaction, and increments the transfailure statistics.
nReRegDuration	In the event that IxLoad fails to register with a registrar, this field defines the amount of time allowed to re-registration.
bNextOnFail	If <code>true</code> and IxLoad encounters a transaction failure, it continues processing SIP requests.



## Media Settings

The SIP Client Agent Media Settings command selects and configures the streaming audio files for the multimedia session that the client will play over RTP. Refer to `Media Settings` for a full description of this command. The most significant options of this command are listed below.

Option	Description
szCodecName	Codec to be used to encode waveform audio files listed in the Audio Clips Pool.
szCodecDetails	Displays the properties of the codec such as the number of bytes per frame of compressed audio, and the rate at which packets are sent over the connection.
szCodecDescr	Codec description.
bModifyPowerLevel	If <code>true</code> , IxLoad modifies the volume of the compressed audio.
szPowerLevel	If <code>bModifyPowerLevel</code> is <code>true</code> , this parameter specifies the amount of gain (volume) added to compressed audio.
bUseJitter	Enables or disables use of the jitter buffer.
bJitMs	Defines the method used to set the jitter buffer size.
nJitterBuffer	Jitter Buffer size, in packets.
nJitterMs	Jitter Buffer size, in milliseconds.
bUseCompensation	Enables or disables use of the compensation jitter buffer.
bCompMs	Defines the method used to set the compensation jitter buffer size.
nCompJitterBuffer	Compensation jitter buffer maximum size, in packets.
nCompJitterMs	Compensation jitter buffer maximum size, in milliseconds.
nCompMaxDropped	Maximum dropped consecutive packets.
bUseMOS	Enables or disables use of MOS.
bMosOnMax	Defines whether MOS is calculated for a subset of streams or for all streams.
nMosMaxStreams	Maximum number of concurrent streams used in MOS calcu
nMosInterval	Frequency at which IxLoad samples the RTP streams to get the MOS scores.

nDtmfDuration	Length of time allowed to play the DTMF sequence.
nDtmfInterdigits	Duration (in milliseconds) of the DTMF interdigit signal.
bLimitDtmf	Enable or disable limitation on the number of DTMF streams to be processed.
nDtmfStreams	Number of streams to which path confirmation will be applied.
nPcInterval	If Synthetic path confirmation is selected, this is the interval at which IxLoad add the synthetic RTP packets to the stream.
nSessionType	Type of voice session.
szDtmfSeq	DTMF sequence used for path confirmation.
szPeerCodecName	Name of codec used by peer.
szPeerCodecDetails	Details of codec used by peer.
szPeerDtmfSeq	DTMF sequence used by peer.
nPeerDtmfDuration	DTMF duration used by peer.
nPeerDtmfInterdigits	Inter-digits interval used by peer.
audioClipsTable	This list contains the waveform audio files that the SIP client will play.

## Audio Clips Pool

The SIP Client Agent Audio Clips Pool defines an audio file to be included in the list that the SIP client will play. Refer to `Audio Clips Pool` for a full description of this command. The most significant options of this command are listed below.

Option	Description
<code>szWaveName</code>	Waveform audio (.wav) file.
<code>szDataFormat</code>	Encoding format of waveform audio file.
<code>nSampleRate</code>	Number of samples taken per second from the recording source.
<code>nResolution</code>	Number of bits per sample.
<code>nChannels</code>	Number of audio channels.
<code>nDuration</code>	Playing time of audio file.
<code>nSize</code>	Size of audio file, in bytes.
<code>szRawWaveName</code>	Name and path of wave file to be added to the list.

## Video Settings

The Video Settings tab defines the controls that you can use to define the paramof the synthetic video the SIP server generates for a MEDIASESSION sceRefer to `Video Settings` for a full description of this command. The most significant options of this command are listed below.

Option	Description
<code>videoBitrate</code>	Bit rate of generated (synthetic) video data.
<code>videoBitrateLimit</code>	The <code>videoBitrate</code> limit in Kbps.

## Scenarios

The SIP Client Agent Scenarios is the list of SIP commands that the client will send to a SIP server. Refer to `Scenarios` for a full description of this command. The most significant options of this command are listed below.

Option	Description
id	SIP command to be executed.

## SIP Server Commands

The structure of the SIP server API is shown below.

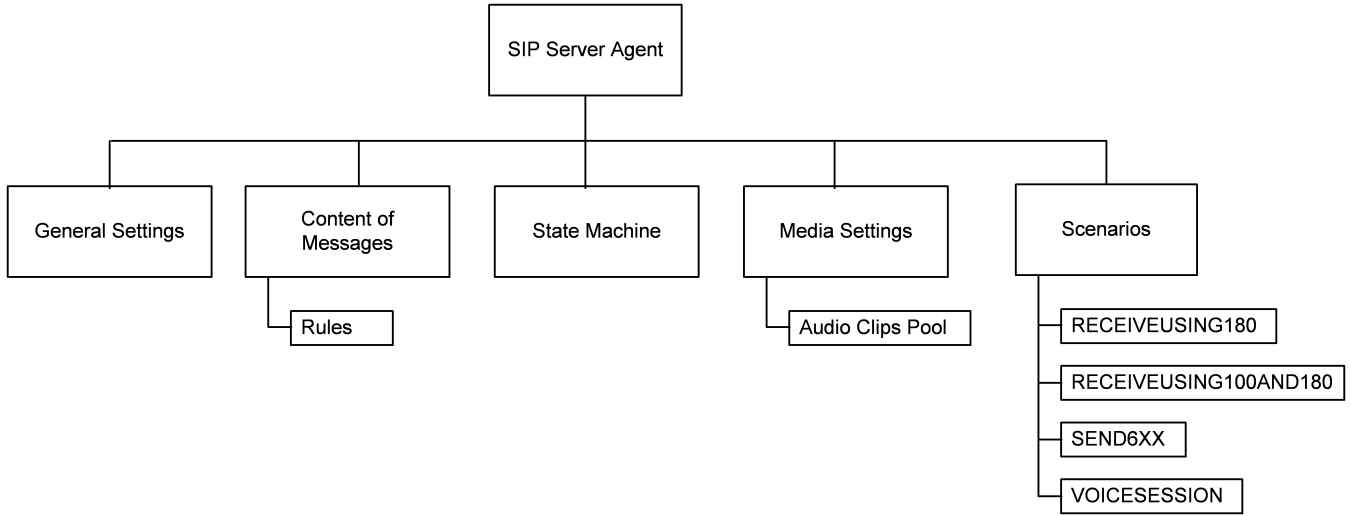

## SIP Server Agent

The SIP Server Agent command defines a simulated user using SIP to establish and terminate sessions SIP. Refer to `SIP Server Agent` for a full description of this command. The most significant options of this command are listed below.

Option	Description
enable	Enables the use of this client agent.
name	The name associated with this object, which must be set at object creation time .
protocol	Protocol used by the client agent.
type	Defines the agent as either a client or server.

## General Settings

The SIP Server Agent General Settings command sets the SIP server agent's genconfiguration options. The options for this command are similar to those for the SIP client agent.



## Content of Messages

The SIP Server Agent Content of Messages command specifies the content of the SIP messages sent by the server. The options for this command are similar to those for the SIP client agent.

## Rules

The SIP Server Agent Rules command defines a rule for handling a SIP message. The options for this command are similar to those for the SIP client agent.

## State Machine

The SIP Server Agent State Machine command configures the SIP server agent's internal timers and other parameters of its state machine. The options for this command are similar to those for the SIP client agent.

## Media Settings

The SIP Server Agent Media Settings command selects and configures the streaming audio files for the multimedia session that the server will play over RTP. The options for this command are similar to those for the SIP client agent.

## Audio Clips Pool

The SIP Server Agent Audio Clips Pool defines an audio file to be included in the list that the SIP server will play. The options for this command are similar to those for the SIP client agent.

## Scenarios

The SIP Server Agent Scenarios is the list of SIP commands that the server will send to a SIP client. The options for this command are similar to those for the SIP client agent.

## SIP Client Agent

SIP Client Agent - create a SIP client

### SYNOPSIS

```
set Traffic1_Network1 [::IxLoad new ixNetTraffic]
set Activity_SIPClient1 [$Traffic1_Network1 activityList.appendItem options...]
$Activity_SIPClient1 agent.config
```

### DESCRIPTION

An SIP client agent is added to the `activityList` object. The `activityList` object is added to the `ixNetTraffic` object using the `appendItem` subcommand from the `ixConfigSequenceContainer` command.

### SUBCOMMANDS

The options for this command are configured and read using the standard `config`, `cget`, and `getOption` subcommands defined in the `ixConfig` command.

### OPTIONS

`enable`

Enables the use of this client agent. (Default = true).

`name`

The name associated with this object, which must be set at object creation time.

### STATISTICS

#### EXAMPLE

```
set Traffic1_Network1 [::IxLoad new
ixNetTraffic]##### Activity SIPClient1
of NetTraffic Traffic1@Network1#####set
Activity_SIPClient1 [$Traffic1_Network1 activityList.appendItem \-protocolAndType
"SIP Client" ]##### Timeline1 for activ-
ities SIPClient1#####set Timeline1
[::IxLoad new ixTimeline]$Timeline1 config \-rampUpValue
1 \-rampUpType 0 \-offlineTime
0 \-rampDownTime 20 \-standbyTime
0 \-iterations 1 \-rampUpInterval
1 \-sustainTime 20 \-timelineType
0 \-name "Timeline1"$Activity_SIPClient1 config
\-enable true \-name
"SIPClient1" \-enableConstraint false \-userObjectiveValue
```

```

100 \-constraintValue
"useragents" \-timeline
ent1 agent.config \-enable
"SIPClient1"$Activity_SIPClient1 agent.pm.generalSettings.config \-dhcpServerPort
5060 \-ipv6Form
false \-bRegBefore
"Best Effort (0x0)" \-_gbDhcpServerPort
1024 \-nUdpPort
"domain\[0000-\]" \-vlan_priority_sip
false \-enableTosSIP
true \-ipPreference
false \-nPefQop
"127.0.0.1:5060" \-enableVlanPriority_for_sip
5060 \-szTransport
"password\[0000-\]" \-type_of_service_for_sip
szAuthUsername
false \-compressZeros
m.mediaSettings.config \-nPcInterval
1 \-nDtmfInterdigits
7 \-nPeerDtmfDuration
20 \-bSilenceMode
1178615586 \-szBitRate
100 \-szPeerCodecName
"" \-bytesPerFrameBuffer
false \-szPeerCodecDetails
0 \-groupBox_JB1
3 \-nCompJitterBuffer
false \-szCodecName
"" \-bLimitDtmf
false \-bJitMs
"ITU-T G.711 is a standard to represent 8 bit compressed pulse code modulation (PCM)
samples for signals of voice frequencies, sampled at the rate of 8000
samples/second. G.711 encoder will create a 64 Kbps bitstream. A-Law G.711 PCM
encoder converts 13 bit linear PCM samples into 8 bit compressed PCM (logarithmic
form) samples, and the decoder does the conversion vice versa." \-bCompMs
0 \-nDtmfStreams
"" \-szPowerLevel
"12345" \-nCompJitterMs
0 \-bRtpStartCollector
1 \-szCodecDetails
0 \-bUseSilence
false \-bUseCompensation
m.contentOfMessages.config \-bFolding
bBestPerformance
"Route: <sip:p1.example.com;lr>,<sip:p2.domain.com;lr>" \-bOptional
false \-szCONTACT
false \-bCompact

100 \-userObjectiveType
$Timeline1$Activity_SIPCli-
true \-name
0 \-bRemoveCredent
false \-type_of_service_for_rtp
false \-nUdpMaxSize
5060 \-szAuthDomain
0 \-useDhcp
false \-implicitLoopCheck
0 \-_gbIpPreference
0 \-szRegistrar
false \-nTcpPort
"UDP" \-szAuthPassword
"Best Effort (0x0)" \-
"user\[0000-\]" \-enableTosRTP
false$Activity_SIPClient1 agent.p-
500 \-nJitterBuffer
40 \-nCompMaxDropped
0 \-nJitterMs
1 \-nAudioPoolTime
"64 kbps" \-nDtmfDuration
"" \-szSilenceFile
"" \-groupBox_MOS1
"" \-bMosOnMax
false \-nMosInterval
50 \-bUseJitter
"G711ALaw" \-szPeerDtmfSeq
true \-bUseMOS
0 \-szCodecDescr
10 \-packetTimeBuffer
"PL_20" \-szDtmfSeq
1000 \-nPeerDtmfInterdigits
false \-nMosMaxStreams
"BF160PT20" \-nSessionType
false \-bModifyPowerLevel
false$Activity_SIPClient1 agent.p-
false \-
1 \-szRoute
"<sip:id\[0000-\]@IP>" \-bAdvisable
false \-bRoute

```



```

false \-szFROM                                "<sip:id\[0000-\]@IP>" \-szTO
"<sip:id\[5000-\]@IP>" \-szREQUESTURI          "sip:id\[5000-
\]@IP" \-bScattered                            false$Activity_SIPClient1 agent.p-
m.contentOfMessages.rulesTable.clear$Activity_SIPClient1 agent.p-
m.stateMachine.config \-bNextOnFail            true \-nTimersT4
5000 \-nReRegDuration                          0 \-nTimersT1
500 \-nTimersT2                                4000 \-bUseTimer
false \-nTimeout                              30000 \-nTimersTD
32000 \-nTimersTC                             180000 \-bRecv5xx
false$Activity_SIPClient1 agent.pm.videoSettings.config \-videoBitrate
128.0 \-videoBitrateLimit                     0$Activity_SIPClient1 agent.p-
m.scenarios.clear$Activity_SIPClient1 agent.pm.scenarios.appendItem \-id
"ORIGINATECALL" \-symDestination               "Traffic2_SIPServer1:5060"
\-bNextCommandIsDetect                        false \-isLastCmd
false \-useDhcpForOriginate                    false \-hasVideo
false \-_gbDhcpServerPortForOriginate         false \-dhcpServerPortForOriginate
5060$Activity_SIPClient1 agent.pm.scenarios.appendItem \-id
"ENDCALL" \-isLastCmd                         false \-szDummy03
""$Activity_SIPClient1 agent.pm.predefined_tos_for_rtp.clear$Activity_SIPClient1
agent.pm.predefined_tos_for_rtp.appendItem \-id
"TypeOfServiceForRTP" \-tos_val_for_rtp        "Best Effort
(0x0)"$Activity_SIPClient1 agent.pm.predefined_tos_for_rtp.appendItem \-id
"TypeOfServiceForRTP" \-tos_val_for_rtp        "Class 1
(0x20)"$Activity_SIPClient1 agent.pm.predefined_tos_for_rtp.appendItem \-id
"TypeOfServiceForRTP" \-tos_val_for_rtp        "Class 2
(0x40)"$Activity_SIPClient1 agent.pm.predefined_tos_for_rtp.appendItem \-id
"TypeOfServiceForRTP" \-tos_val_for_rtp        "Class 3
(0x60)"$Activity_SIPClient1 agent.pm.predefined_tos_for_rtp.appendItem \-id
"TypeOfServiceForRTP" \-tos_val_for_rtp        "Class 4
(0x80)"$Activity_SIPClient1 agent.pm.predefined_tos_for_rtp.appendItem \-id
"TypeOfServiceForRTP" \-tos_val_for_rtp        "Express Forwarding
(0xA0)"$Activity_SIPClient1 agent.pm.predefined_tos_for_rtp.appendItem \-id
"TypeOfServiceForRTP" \-tos_val_for_rtp        "Control
(0xC0)"$Activity_SIPClient1 agent.pm.predefined_tos_for_rtp.appendItem \-id
"TypeOfServiceForRTP" \-tos_val_for_rtp        "Best Effort
(0x0)"$Activity_SIPClient1 agent.pm.predefined_tos_for_sip.clear$Activity_SIPClient1
agent.pm.predefined_tos_for_sip.appendItem \-id
"TypeOfServiceForSIP" \-tos_val_for_sip        "Best Effort
(0x0)"$Activity_SIPClient1 agent.pm.predefined_tos_for_sip.appendItem \-id
"TypeOfServiceForSIP" \-tos_val_for_sip        "Class 1
(0x20)"$Activity_SIPClient1 agent.pm.predefined_tos_for_sip.appendItem \-id
"TypeOfServiceForSIP" \-tos_val_for_sip        "Class 2
(0x40)"$Activity_SIPClient1 agent.pm.predefined_tos_for_sip.appendItem \-id
"TypeOfServiceForSIP" \-tos_val_for_sip        "Class 3
(0x60)"$Activity_SIPClient1 agent.pm.predefined_tos_for_sip.appendItem \-id
"TypeOfServiceForSIP" \-tos_val_for_sip        "Class 4
(0x80)"$Activity_SIPClient1 agent.pm.predefined_tos_for_sip.appendItem \-id

```

```
"TypeOfServiceForSIP" \-tos_val_for_sip           "Express Forwarding
(0xA0)"$Activity_SIPClient1 agent.pm.predefined_tos_for_sip.appendItem \-id
"TypeOfServiceForSIP" \-tos_val_for_sip           "Control
(0xC0)"$Activity_SIPClient1 agent.pm.predefined_tos_for_sip.appendItem \-id
"TypeOfServiceForSIP" \-tos_val_for_sip           "Best Effort (0x0)"
```

### **SEE ALSO**

[ixNetTraffic](#)

## General Settings

General Settings—Sets the SIP client agent's general configuration options.

### SYNOPSIS

```
set Traffic1_Network1 [::IxLoad new ixNetTraffic]
set Activity_SIPClient1 [$Traffic1_Network1 activityList.appendItem options...]
$Activity_SIPClient1 agent.pm.generalSettings.config
```

### DESCRIPTION

A SIP client's advanced configuration options are set by modifying the options of the `pm.generalSettings` option of the `SIP Client Agent` object.

### SUBCOMMANDS

None.

### OPTIONS

`ipv6Form`

Specifies `0` (ipv4) or `1` (ipv6) to determine the types of networks (in the `ixNetTraffic`) that the SIP client and server use.

All the fields that support IPv4 addresses also support IPv6 addresses. There are two methods for entering IPv6 addresses in SIP fields: in square brackets (`[ ]`) or in vertical bar (pipe) symbols (`|`).

For the following options, enclose the address in square brackets (`[ ]`). For example `[::C212:1003]:5060`

- `szRegistrar;`
- `ORIGINATECALL` command
- `REGISTRATION` command
- `REDIRECTION` command

For information on these options, see `Scenarios`.

In the `Content of Messages` object, the following four options accept IPV6 addresses. Enclose the address for these options in vertical bar (pipe) symbols (`|`). (square brackets are used to enclose sequence generators). The options are:

```
szREQUESTURI
szFROM
szTO
szCONTACT
```

`szAuthUsername`

User name to be registered with registrar. You can include variables in this field to automatically generate large numbers of unique user names. See *Using Variables in SIP Fields* on page 20-80. Maximum length = 128 characters. (Default = "user[0000-]").

szAuthPassword

Password to be registered with registrar. You can include variables in this field to automatically generate large numbers of unique passwords. See *Using Variables in SIP Fields* on page 20-80. Maximum length = 128 characters.

(Default = "password[0000-]").

szAuthDomain

Domain to be registered with registrar. You can include variables in this field to automatically generate large numbers of unique domains. See *Using Variables in SIP Fields* on page 20-80. Maximum length = 128 characters. (Default = "domain[0000-]").

szTransport

Type of transport to be used. The choices are:

Value	Description
TCP	IxLoad initially uses TCP as the transport. If the remote party answers using UDP, IxLoad accepts the response and switches to UDP as the trans
UDP	IxLoad initially uses UDP as the transport. If the remote party answers using TCP, IxLoad accepts the response and switches to TCP as the trans
Only TCP	IxLoad uses only TCP as the transport. If the remote party answers using UDP, IxLoad discards the response and continues using TCP.
Only UDP	IxLoad uses only UDP as the transport. If the remote party answers using TCP, IxLoad discards the response and continues using UDP.

nUdpPort

Port number to be used for sending and receiving SIP messages over UDP. Mini= "1," maximum = "65,535." (Default = "5,060").

nTcpPort

Port number to be used for sending and receiving SIP messages over TCP. Mini= "1," maximum = "65,535." (Default = "5,060").

nUdpMaxSize

Maximum size, in Kb, of a SIP message that will be sent. If a message exceeds this size, IxLoad ignores it.

szRegistrar

Host name or IP address and port number of registrar. This option also accepts IPV6 addresses that are enclosed in square brackets. (Default = "127.0.0.1:5060").

bRegBefore

If `true`, before starting the Originate Call/EnCall --> Receive call process, the IxLoad SIP client registers with the proxy server. Registration occurs only once at the beginning of the test. (Default = "0").

enableTosSIP

Enables the setting of the TOS (Type of Service) bits in the header of the SIP packets.

Value	Description
0	(default) TOS bits disabled.
1	TOS bits enabled.

enableTosRtp

Enables the setting of the TOS (Type of Service) bits in the header of the RTP data packets.

Value	Description
0	(default) TOS bits disabled.
1	TOS bits enabled.

type\_of\_service\_for\_sip

If `enableTosSIP` is `true`, this option specifies the IP Precedence / TOS (Type of Service) bit setting and Assured Forwarding classes. (Default = "Best Effort 0x0"). If you want to specify the standard choices that are in the GUI, you can use a string representation. To specify any of the other 255 TOS values, specify the decimal value. The default choices are:

Value	Description
"Best Effort (0x0)"	(Default) routine priority
"Class 1 (0x20)"	Priority service, Assured Forwarding class 1
"Class 2 (0x40)"	Immediate service, Assured Forwarding class 2
"Class 3 (0x60)"	Flash, Assured Forwarding class 3
"Class 4 (0x80)"	Flash-override, Assured Forwarding class 4
"Express Forwarding (0xA0)"	Critical-ecp

"Control (0xC0)"	Internet-control
------------------	------------------

type\_of\_service\_for\_rtp

If `enableTosRtp` is true, this option specifies the IP Precedence / TOS (Type of Service) bit setting and Assured Forwarding classes for RTP data packets. See `type_of_service_for_sip` for the list of choices. (Default = "Best Effort (0x0)").

enableVlanPriority\_for\_sip

VLAN Priority can be set on a per-activity basis or on a per-network (NetTraffic) basis. This parameter sets the VLAN priority for the activity. An activity's VLAN Priority bit setting takes precedence over a network's Priority bit setting. If true, IxLoad sets the VLAN Priority bit in traffic from this activity. Configure the VLAN priority value in `vlanPriority`. (Default = false).

vlanPriority

When `enableVlanPriority` is true, this option sets the vlan priority value.

### EXAMPLE

```
$Activity_SIPClient1 agent.pm.generalSettings.config \-dhcpServerPort
5060 \-ipv6Form 0 \-bRemoveCredent
false \-bRegBefore false \-type_of_service_for_rtp
"Best Effort (0x0)" \-_gbDhcpServerPort false \-nUdpMaxSize
1024 \-nUdpPort 5060 \-szAuthDomain
"domain\[0000-\]" \-vlan_priority_sip 0 \-useDhcp
false \-enableTosSIP false \-implicitLoopCheck
true \-ipPreference 0 \-_gbIpPreference
false \-nPrefQop 0 \-szRegistrar
"127.0.0.1:5060" \-enableVlanPriority_for_sip false \-nTcpPort
5060 \-szTransport "UDP" \-szAuthPassword
"password\[0000-\]" \-type_of_service_for_sip "Best Effort (0x0)" \-
szAuthUsername "user\[0000-\]" \-enableTosRTP
false \-compressZeros false
```

### SEE ALSO

[SIP Client Agent](#)

## Content of Messages

Content of Messages—Specifies the content of the SIP messages sent by the cli

### SYNOPSIS

```
set Traffic1_Network1 [::IxLoad new ixNetTraffic]
set Activity_SIPClient1 [$Traffic1_Network1 activityList.appendItem options...]
$Activity_SIPClient1 agent.pm.contentOfMessages.config
```

### DESCRIPTION

A SIP client's advanced configuration options are set by modifying the options of the `pm.contentOfMessages` option of the `SIP Client Agent` object.

### SUBCOMMANDS

None.

### OPTIONS

`bRoute`

If `true`, `IxLoad` inserts a `Route` header field into the SIP message. The route should contain a list of specified proxies. Use the `szRoute` parameter to specify the route. (Default = `"0"`).

`szRoute`

If `bRoute` is `true`, this parameter specifies the `Route` header field used to force the request to follow a fixed route through a listed set of proxies. (Default = `"Route: <sip:pl.example.com;lr>, <sip:p2.domain.com;lr>."`).

`bCompact`

If `true`, `IxLoad` uses the compact forms of the SIP header field notations. The compact form is intended for instances in which messages would otherwise become too large to be carried on the transport available to it (exceeding the maximum transmission unit [MTU] when using UDP, for example). (Default = `"0"`).

`bFolding`

If `true`, the `VIA` field spans two lines. Some SIP devices may not be able to handle this. (Default = `"0"`).

`bScattered`

If `true`, `IxLoad` moves the header fields around in the message in order to make it more difficult for the DUT to decode the message. (Default = `"0"`).

`bAdvisable`

If `true`, the SIP request includes the header fields that are defined as 'mandatory' by the SIP RFC (RFC 3261), plus those that are recommended as 'advisable.' (Default = "0").

`bOptional`

If `true`, the SIP request includes the header fields that are defined as 'mandatory' by the SIP RFC (RFC 3261), plus those that are listed as 'optional.' (Default = "0").

`bBestPerformance`

If `true`, `IxLoad` inserts the headers into the message so that the message can be processed as quickly as possible by the receiving system. If `false`, `IxLoad` inserts the headers into the message so that it requires maximum processing by the receiving system. (Default = "1").

`szREQUESTURI`

User or service to which the SIP request is being addressed. You can include variables in this field to automatically generate large numbers of unique domains. Maximum length = 128 characters. This option also accepts IPV6 addresses that are enclosed in square brackets (Default = "sip:id[50000-]@IP").

`szFROM`

Initiator of the SIP request. You can include variables in this field to autogenerate large numbers of unique domains. This option also accepts IPV6 addresses that are enclosed in square brackets. (Default = "sip:id[50000-]@IP").

`szTO`

Logical recipient of the request. You can include variables in this field to autogenerate large numbers of unique domains. Maximum length = 128 characters. This option also accepts IPV6 addresses that are enclosed in square brackets. (Default = "sip:id[50000-]@IP").

`szCONTACT`

The Contact header field value provides a URI whose meaning depends on the type of request or response it is in. The Contact header field has a role similar to the Location header field in HTTP. You can include variables in this field to autogenerate large numbers of unique domains. See *Using Variables in SIP Fields* on page 20-80. Maximum length = 128 characters. This option also accepts IPV6 addresses that are enclosed in square brackets. (Default = "sip:id[50000-]@IP").

`rulesTable`

This is a list of type `Rules`. The rules in this list define how this message will be handled. (Default = {}).

## EXAMPLE

```
$Activity_SIPClient1 agent.pm.contentOfMessages.config \-bFolding
false \-bBestPerformance 1 \-szRoute
"Route: <sip:p1.example.com;lr>,<sip:p2.domain.com;lr>" \-bOptional
false \-szCONTACT "<sip:id\[00000-\]@IP>" \-bAdvisable
false \-bCompact false \-bRoute
```



```
false \-szFROM  
"<sip:id\[50000-\]@IP>" \-szREQUESTURI  
\]@IP" \-bScattered
```

```
"<sip:id\[00000-\]@IP>" \-szTO  
"sip:id\[50000-\]  
false
```

**SEE ALSO**

[SIP Client Agent](#)

## State Machine

State Machine—Configures the SIP client agent's internal timers and other parameters of its state machine.

### SYNOPSIS

```
set Traffic1_Network1 [::IxLoad new ixNetTraffic]
set Activity_SIPClient1 [$Traffic1_Network1 activityList.appendItem options...]
$Activity_SIPClient1 agent.pm.stateMachine.config
```

### DESCRIPTION

A SIP client's state machine parameters are set by modifying the options of the `pm.StateMachine` option of the `SIP Client Agent` object.

### SUBCOMMANDS

None.

### OPTIONS

`nTimersT1`

Estimate of the round-trip time (RTT), in milliseconds (ms). (Default = "500").

`nTimersT2`

Maximum retransmit interval, in milliseconds (ms), for non-INVITE requests and INVITE responses. (Default = "4,000").

`nTimersT4`

Maximum length of time, in milliseconds (ms), that a message will remain in the network. (Default = "5,000").

`nTimersTC`

Proxy INVITE transaction timeout. Minimum = 180,000. (Default = "180,000").

`nTimersTD`

Wait time for response retransmits. For UDP, this must be greater than 32 sec (Default = "32,000").

`bUseTimer`

If `true`, `IxLoad` enforces a timeout limit on transactions. If a transaction exceeds the timeout value, `IxLoad` marks it as a failed transaction, and increments the transaction failure statistics. (Default = "0").

`nTimeout`

If `bUseTimer` is true, this parameter specifies the transaction timeout interval, in milliseconds (ms). (Default = "30,000").

`bRecv5xx`

If true and `IxLoad` receives a 5xx series response to a transaction, `IxLoad` marks it as a failed transaction, and increments the transaction failure statistics. (Default = "0").

`nReRegDuration`

In the event that `IxLoad` fails to register with a registrar, this field defines the amount of time allowed to re-registration. Minimum = "0," maximum = "60,000." (Default = "0").

`bNextOnFail`

If true and `IxLoad` encounters a transaction failure, it continues processing SIP requests. If false and `IxLoad` encounters a transaction failure, it stops processing SIP requests. (Default = "1").

### EXAMPLE

```
$Activity_SIPClient1 agent.pm.stateMachine.config \-bNextOnFail
true \-nTimersT4 5000 \-nReRegDuration
0 \-nTimersT1 500 \-nTimersT2
4000 \-bUseTimer false \-nTimeout
30000 \-nTimersTD 32000 \-nTimersTC
180000 \-bRecv5xx false
```

### SEE ALSO

[SIP Client Agent](#)

## Media Settings

Media Settings—Selects and configures the streaming audio files for the multimedia session that the client will play over RTP.

### SYNOPSIS

```
set Traffic1_Network1 [::IxLoad new ixNetTraffic]
set Activity_SIPClient1 [$Traffic1_Network1 activityList.appendItem options...]
$Activity_SIPClient1 agent.pm.mediaSettings.config
```

### DESCRIPTION

A SIP client's advanced configuration options are set by modifying the options of the `pm.mediaSettings` option of the `SIP Client Agent` object.

### SUBCOMMANDS

None.

### OPTIONS

`szCodecName`

Codec to be used to encode waveform audio files listed in the Audio Clips Pool. The choices are:

Value	Description
"G711ALaw"	(default) G.711 A-law
"G711ULaw"	G.711 mu-law
"G729A"	G.729A
"G729B"	G.729B
"G726"	G.726
"G723_1"	G.723.1

`szCodecDetails`

Displays the properties of the codec such as the number of bytes per frame of compressed audio, and the rate at which packets are sent over the connection. (Default = {}).

`szCodecDetails` from Media Settings has a special format: `BFval1PTval2`, where:

Value	Description
-------	-------------

"val1"	Number of codec bytes per frame (only the rtp payload; do not add the 12 bytes for the rtp header)
"val2"	The packet time

These two options specify information about the packetization.

`szCodecDescr`

Codec description. (Default = {}).

`szBitRate`

This specifies the bit rate of the codec being used. Possible values are:

Codec	Bit Rate
G711Alaw	64 kbps
G711Ulaw	64 kbps
G723.1	5.3 kbps 6.3 kbps
G726	40 kbps
G729A	8 kbps
G729B	8 kbps
AMR	4.75 kbps 5.15 kbps 5.9 kbps 6.7 kbps 7.4 kbps 7.95 kbps 10.2 kbps 12.2 kbps
iLBC	13.33 kbps 15.2 kbps

`bModifyPowerLevel`

If `true`, `IxLoad` modifies the volume of the compressed audio. (Default = "0").

`szPowerLevel`

If `bModifyPowerLevel` is true, this parameter specifies the amount of gain (volume added to compressed audio). The choices are :

Value	Description
"PLO"	(default) 0 dB
"PL_10"	-10 dB
"PL_20"	-20 dB
"PL_30"	-30 dB

`bUseJitter`

Enables or disables use of the jitter buffer. (Default = "0").

`bJitMs`

Defines the method used to set the jitter buffer size.

Value	Description
0	(Default). Jitter buffer size is set by <code>nJitterBuffer</code> .
1	Jitter buffer size is set by <code>nJitterMs</code> .

`nJitterBuffer`

Number of packets to buffer in order to reduce jitter. Minimum = "0," maximum = "3." (Default = 0).

`nJitterMs`

Jitter Buffer size, in milliseconds. Minimum = "1," maximum = "3,000." (Default = "20").

`bUseCompensation`

Enables or disables use of the compensation jitter buffer. (Default = "0").

`bCompMs`

Defines the method used to set the compensation jitter buffer size.

Value	Description
-------	-------------

0	(Default). Compensation jitter buffer size is set by <code>nCompJitterBuffer</code> .
1	Compensation jitter buffer size is set by <code>nCompJitterMs</code> .

`nCompJitterBuffer`

Compensation jitter buffer maximum size, in packets. Minimum = "0," maximum = "300." (Default = "50").

`nCompJitterMs`

Compensation jitter buffer maximum size, in milliseconds. Minimum = "0," maximum = "3,000." (Default = "1,000").

`nCompMaxDropped`

Maximum dropped consecutive packets. Minimum = "1," maximum = "100," (Default = "7").

`bUseMOS`

Enables or disables use of MOS. (Default = "0").

`bMosOnMax`

Defines whether MOS is calculated for a subset of streams or for all streams.

Value	Description
0	(Default). MOS calculation is applied to all streams.
1	MOS calculation is applied to the number of streams specified by <code>nMosMax</code> .

`nMosMaxStreams`

Maximum number of concurrent streams used in MOS calculation. Minimum = "1." (Default = "1").

`nMosInterval`

Frequency at which `IxLoad` samples the RTP streams to generate the MOS scores. Minimum = "2," maximum = "30." (Default = "3").

`nDtmfDuration`

Length of time allowed to play the DTMF sequence. Minimum = "60," maximum = "999." (Default = "100").

`nDtmfInterdigits`

Duration (in milliseconds) of the DTMF interdigit signal. Minimum = "30," maximum = "9999." (Default = "40").

`bLimitDtmf`

Enable or disable limitation on the number of DTMF streams to be processed. (Default = "1").

Value	Description
0	DTMF applied to all streams.
1	(Default) DTMF limited to number of streams specified by <code>nDtmfStreams</code> .

#### `nDtmfStreams`

Number of streams to which path confirmation will be applied. Minimum = "1," maximum = "900."  
(Default = "10").

#### `nPcInterval`

If Synthetic path confirmation is selected, this is the interval at which IxLoad add the synthetic RTP packets to the stream. Minimum = "1," (Default = "500").

#### `nSessionType`

Type of voice session. The choices are:

Value	Description
"0"	(default) Plays audio file specified by <code>szAudioFile</code> .
"1"	Perform DTMF path confirmation.
"2"	Perform synthetic DTMF path confirmation.

#### `szDtmfSeq`

DTMF sequence used for path confirmation. (Default = "12,345").

#### `szPeerCodecName`

Name of codec used by peer. (Default = {}). .

#### `szPeerCodecDetails`

Details of codec used by peer. (Default = {}). .

#### `szPeerDtmfSeq`

DTMF sequence used by peer. (Default = {}). .

#### `nPeerDtmfDuration`



DTMF duration used by peer. (Default = "0").

nPeerDtmfInterdigits

Inter-digits interval used by peer. (Default = "0").

audioClipsTable

This is a list of type `Audio Clips Pool`. This list contains the waveform audio files that the SIP message will send. (Default = {}).

bUseSilence

If enabled, `IxLoad` generates and sends artificial background noise during times of silence during a call.

bSilenceMode

Indicates the method used to generate the background noise. Possible Values are:

Value	Description
"0"	Comfort Noise silence type.
"1"	Null Data encoded silence type.

bRtpStartCollector

Specifies, whether the statistics for rtp should be collected or not. Possible values are:

Value	Description
0	Do not start
1	Start

## EXAMPLE

```
$Activity_SIPClient1 agent.pm.mediaSettings.config \-nPcInterval
500 \-nJitterBuffer 1 \-nDtmfInterdigits
40 \-nCompMaxDropped 7 \-nPeerDtmfDuration
0 \-nJitterMs 20 \-bSilenceMode
1 \-nAudioPoolTime 1178615586 \-szBitRate
"64 kbps" \-nDtmfDuration 100 \-szPeerCodecName
"" \-szSilenceFile "" \-bytesPerFrameBuffer
```

```
"" \-groupBox_MOS1                false \-szPeerCodecDetails
"" \-bMosOnMax                    0 \-groupBox_JB1
false \-nMosInterval              3 \-nCompJitterBuffer
50 \-bUseJitter                   false \-szCodecName
"G711ALaw" \-szPeerDtmfSeq        "" \-bLimitDtmf
true \-bUseMOS                    false \-bJitMs
0 \-szCodecDescr                  "ITU-T G.711 is a standard to represent
8 bit compressed pulse code modulation (PCM) samples for signals of voice fre-
quencies, sampled at the rate of 8000 samples/second. G.711 encoder will create a 64
Kbps bitstream. A-Law G.711 PCM encoder converts 13 bit linear PCM samples into 8
bit compressed PCM (logarithmic form) samples, and the decoder does the conversion
vice versa." \-bCompMs            0 \-nDtmfStreams
10 \-packetTimeBuffer             "" \-szPowerLevel
"PL_20" \-szDtmfSeq               "12345" \-nCompJitterMs
1000 \-nPeerDtmfInterdigits       0 \-bRtpStartCollector
false \-nMosMaxStreams            1 \-szCodecDetails
"BF160PT20" \-nSessionType        0 \-bUseSilence
false \-bModifyPowerLevel         false \-bUseCompensation
false
```

**SEE ALSO**

[SIP Client Agent](#)

## Video Settings

Video Settings—Contains the controls that you can use to define the parameters of the synthetic video the SIP server generates for a MEDIASESSION scenario.

### SYNOPSIS

```
set Traffic1_Network1 [::IxLoad new ixNetTraffic]
set Activity_SIPClient1 [$Traffic1_Network1 activityList.appendItem options...]
$Activity_SIPClient1 agent.pm.videoSettings.config \
```

### DESCRIPTION

Video Settings is configured and added to an SIP activity.

### SUBCOMMANDS

The options for this command are configured and read using the standard `config`, `cget`, and `getOption` subcommands defined in the `ixConfig` command.

### OPTIONS

`videoBitrate`

Bit rate of generated (synthetic) video data.

`videoBitrateLimit`

The `videoBitrate` limit in Kbps.

### EXAMPLE

```
$Activity_SIPClient1 agent.pm.videoSettings.config \-videoBitrate
128.0 \-videoBitrateLimit 0$Activity_SIPClient1 agent.p-
m.scenarios.clear
```

### SEE ALSO

[Media Settings](#)

## Scenarios

Scenarios—Creates the list of SIP commands that the client will send to a SIP server.

### SYNOPSIS

```
set Traffic1_Network1 [::IxLoad new ixNetTraffic]
set Activity_SIPClient1 [$Traffic1_Network1 activityList.appendItem options...]
$Activity_SIPClient1 agent.pm.scenarios.appendItem
```

### DESCRIPTION

A command is added to the Scenarios object using the `appendItem` subcommand from the `ixConfigSequenceContainer` command.

### SUBCOMMANDS

The options for this command are configured and read using the standard `config`, `cget`, and `getOption` subcommands defined in the `ixConfig` command.

### OPTIONS

`id`

SIP command to be executed. One of the following:

Command	Description
REGISTRATION	Registers the SIP client with a registrar. This option also accepts IPV6 addresses that are enclosed in square brackets.
ORIGINATECALL	Sets up a multimedia session with the specified destination. This option also accepts IPV6 addresses that are enclosed in square brackets.
THINK	Pause during command list processing. You should include a <code>{Think}</code> command whenever necessary to allow the destination to process the preceding commands. You can configure a pause of fixed length or of random length.
ENDCALL	Terminates the SIP session.
REDIRECTION	Redirects the request for a SIP session from one proxy to another. This option also accepts IPV6 addresses that are enclosed in square brackets.
VOICESESSION	Plays one of the waveform audio files listed in the Audio Clips Pool on the Media Settings tab. The SIP client sends the file to the destination configured for the previous Originate Call command in the command list.

GENERATEMF	Generates multi-frequency tone sequences. The sequences are encoded using a G.711 voice codec and sent in-band over RTP.
GENERATEDTMF	Generates dual-tone multi-frequency sequences. The sequences are encoded using a G.711 voice codec and sent in-band over RTP.
GENERATETONE	Generates tone sequences. The sequences are encoded using a G.711 voice codec and sent in-band over RTP.
DETECTDTMF	Detects the tones generated by the DETECTDTMF, DETECTMF, or DETECTTONE commands.
MEDIASESSION	Simulates a call made using a video phone. MEDIASESSION transaudio similar to the VOICESSESSION command and, optionally, generates simulated video data. MEDIASESSION must be preceded by ORIGINATECALL and succeeded by ENDCALL.

### Arguments for id = REGISTRATION

bUseDest

If `true`, the registration is sent to the address specified by `szDestination`. If `false`, the registration is sent to the Registrar configured by the General Settings `com(Default = "1")`.

szDestination

Registrar that the registration will be sent to. This option also accepts IPV6 addresses that are enclosed in square brackets. (Default = "127.0.0.1:5060").

### Arguments for id = ORIGINATECALL

symDestination

Destination of the call. If the destination is an external host, specify its address or host name and port number. If the destination is an IxLoad SIP server agent, specify the name of the agent. This option also accepts IPV6 addresses that are enclosed in square brackets. (Default = "None").

### Arguments for id = THINK

nThinkMin

Minimum length of the pause, in milliseconds. To configure a fixed-length pause, enter the same value in this field and `nThinkMax`. (Default = "1,000").

nThinkMax

Maximum length of the pause, in milliseconds. To configure a fixed-length pause, enter the same value in this field and `nThinkMin`. (Default = "1,000").

### Arguments for id = ENDCALL

None.

### Arguments for id = REDIRECTION

szDestination

Address of the proxy to which the request is to be redirected to. This option also accepts IPV6 addresses that are enclosed in square brackets. (Default = "127.0.0.1:5060").

### Arguments for id = VOICESESSION

szAudioFile

Waveform audio file that will be played during the session. This must be an `szWaveName` object contained within the `Audio Clips Pool` object. (Default = "<None>").

nPlayMode

If `true`, the audio file plays for a fixed number of times. If `false`, the audio file plays continuously. (Default = "0").

nRepeatCount

If `nPlayMode` is `true`, this parameter sets the number of times that the audio file will play. (Default = "1").

nPlayTime

Length of time to play the audio file. Specify the units of time in the `nTimeUnit`.

nTimeUnit

Units of time used to set the audio file play time (`nPlayTime`). The choices are:

Value	Description
"0"	(default) Seconds
"1"	Minutes
"2"	Hours
"3"	Days

### Arguments for id = GENERATEMF

szMfSeq

The sequence of MF digits to be generated.

nMfDuration

Length of time allowed to play the MF sequence. Minimum = "10", Maximum = "990".

nInterMfInterval

Duration (in milliseconds) of the MF interdigit signal. Minimum = "10", Maxi = "9990".

nMfAmplitude

The amplitude of the signal generated by the sending sequence. Minimum = "-30", Maximum = "-10".

nPlayMode

The play mode to play the MF tones. Possible values are:

Value	Description
0	Generate for a specified period of time
1	Repeat for a specified number of times

nRepeatCount

Number of times to repeat the generation of the sequence.

nPlayTime

The time units to play the specified sequence.

nTimeUnit

Signifies the time unit type. Possible values are:

Value	Description
"0"	(default) Seconds
"1"	Minutes
"2"	Hours
"3"	Days

## Arguments for id = GENERATEDTMF

szDtmfSeq

The dtmf sequence to be generated.

nDtmfDuration

Length of time allowed to play the DTMF sequence. Minimum = "10", Maximum = "990".

nDtmfInterdigits

Duration (in milliseconds) of the DTMF interdigit signal. Minimum = "10", Max = "9990".

nDtmfAmplitude

The signal amplitude generated for the stream containing the digits.

nPlayMode

The play mode to play the DTMF tones. Possible values are:

Value	Description
0	Generate the specified sequence for a specified number of times
1	Generate the specified sequence for a specified time

nRepeatCount

Number of time to repeat the generation of the specified sequence.

### Arguments for id = GENERATETONE

nToneName

This is the id for the tone. Possible values are:

Value	Description
0	"600-10"
1	"1400-10"
2	"2500-10"
3	"550-20"
4	"1350-20"
5	"2450-20"
6	"650-30"
7	"2550-30"



8	"1450-30"
9	"3400-10"
10	"3400-30"
11	"2100-10"
12	"2150-30"
13	"400-10"
14	"450-30"
15	"Confirmation Tone"
16	"Call Waiting Tone"
17	"TN_1"
-1	"Custom Tone"

nPlayMode

The play mode to play the MF tones. Possible values are:

Value	Description
0	Generate for a specified period of time
1	Repeat for a specified number of times

nRepeatCount

Number of times to repeat the generation of the sequence.

nPlayTime

The time units to play the specified sequence.

nTimeUnit

Signifies the time unit type. Possible values are:

Value	Description
"0"	(default) Seconds

"1"	Minutes
"2"	Hours
"3"	Days

nToneDuration

The duration of a tone with only one frequency.

nFrequency1

For a single tone, this is the frequency of the signal used to generate the tone. For a dual tone, this is the frequency of the signal used to generate the lower band of the tone.

nFrequency2

For a dual tone, this is the frequency of the signal used to generate the upper band of the tone.

nAmplitude1

Amplitude of the nFrequency1 signal.

nAmplitude2

Amplitude of the nFrequency2 signal.

nOnTime

For a cadenced tone, this is the amount of time the tone signal or signals are played.

nOffTime

For a cadenced tone, this is the amount of time the tone signal or signals are muted.

nRepetitionCount

For a cadenced tone, this specifies the number of times that the On Time / Off Time cycle is repeated.

nToneType

The format of the tone. Possible values:

Value	Description
0	"Single Tone"
1	"Dual Tone"
2	"Single Tone Cadence"
3	"Dual Tone Cadence"

## Arguments for id = DETECTDTMF

nDTMFDetectionMode

Method used to detect tones. Possible values are:

Value	Description
0	detect continuously for a specified time
1	detect exactly a specified number of digits
2	detect a specified sequence

szDtmfSeq

Sequence of digits to detect.

nDetectTime

The number of time units to sustain the detect operation.

nDetectTimeUnit

Signifies the time unit type. Possible values are:

Value	Description
"0"	(default) Seconds
"1"	Minutes
"2"	Hours
"3"	Days

nDtmfCount

The exact number of digits to detect.

nFirstDTMFTimeout

The maximum time for the first digit to arrive and to be decoded.

nInterDTMFInterval

The maximum time between the arrival of digits.

### Arguments for id = MEDIASESSION

nRepeatCount

Number of times to repeat the generation of the sequence.

nWavDuration

The time duration of a wave.

nTimeUnit

Signifies the time unit type. Possible values are:

Value	Description
"0"	(default) Seconds
"1"	Minutes
"2"	Hours
"3"	Days

nPlayMode

The play mode to play the MF tones. Possible values are:

Value	Description
0	Generate for a specified period of time
1	Repeat for a specified number of times

synthVideo

If enabled, the SIP client generates video data and transmits it to the server along with the audio to simulate a video phone call. To configure the video parameters refer [Video Settings](#).

szAudioFile

The name of the audio file that will be played.

szTotalTime

The total time for which an audio file will be played.

nTotalTime

The total time for which a .wav file will be played.

nPlayTime

The time units to play the specified sequence.

**EXAMPLE**

```
$Activity_SIPClient1 agent.pm.scenarios.appendItem \-id
"ORIGINATECALL" \-symDestination "Traffic2_SIPServer1:5060"
\ -bNextCommandIsDetect false \-isLastCmd
false \-useDhcpForOriginate false \-hasVideo
false \- _gbDhcpServerPortForOriginate false \-dhcpServerPortForOriginate
5060$Activity_SIPClient1 agent.pm.scenarios.appendItem \-id
"ENDCALL" \-isLastCmd true \-szDummy03
""
```

**SEE ALSO**

[Video Settings](#)

## SIP Server Agent

SIP Server Agent - create a SIP server

### SYNOPSIS

```
set Traffic2_Network2 [::IxLoad new ixNetTraffic]
set Activity_SIPServer1 [$Traffic2_Network2 activityList.appendItem options...]
$Activity_SIPServer1 agent.config
```

### DESCRIPTION

An SIP server agent is added to the `activityList` object. The `activityList` object is added to the `ixNetTraffic` object using the `appendItem` subcommand from the `ixConfigSequenceContainer` command.

### SUBCOMMANDS

The options for this command are configured and read using the standard `config`, `cget`, and `getOptions` subcommands defined in the `ixConfig` command.

### OPTIONS

`enable`

Enables the use of this agent. (Default = true).

`name`

The name associated with this object, which must be set at object creation time.

### STATISTICS

### EXAMPLE

```
set Traffic2_Network2 [::IxLoad new
ixNetTraffic]##### Activity SIPServer1
of NetTraffic Traffic2@Network2#####set
Activity_SIPServer1 [$Traffic2_Network2 activityList.appendItem \-protocolAndType
"SIP Server" ]set _Match_Longest_ [::IxLoad new ixMatchLongestTimeline]$Activity_
SIPServer1 config \-enable true \-name
"SIPServer1" \-timeline $_Match_Longest_$Activity_
SIPServer1 agent.config \-enable true \-name
"SIPServer1"$Activity_SIPServer1 agent.pm.generalSettings.config \-dhcpServerPort
5060 \-ipv6Form 0 \-bRemoveCredent
false \-bRegBefore false \-type_of_service_for_rtp
"Best Effort (0x0)" \-_gbDhcpServerPort false \-nUdpMaxSize
1024 \-regInterval 0 \-szAuthDomain
"domain\[0000-\]" \-vlan_priority_sip 0 \-useDhcp
```

```

false \-enableTosSIP                                false \-nUdpPort
5060 \-ipPreference                                0 \-_gbIpPreference
false \-nPefQop                                     0 \-szRegistrar
"127.0.0.1:5060" \-enableVlanPriority_for_sip        false \-nTcpPort
5060 \-szTransport                                  "UDP" \-szAuthPassword
"password\[0000-\]" \-type_of_service_for_sip      "Best Effort (0x0)" \-
szAuthUsername                                     "user\[0000-\]" \-enableTosRTP
false \-compressZeros                               false$Activity_SIPServer1 agent.p-
m.mediaSettings.config \-nPcInterval                500 \-nJitterBuffer
1 \-nDtmfInterdigits                               40 \-nCompMaxDropped
7 \-nPeerDtmfDuration                              0 \-nJitterMs
20 \-bSilenceMode                                  1 \-nAudioPoolTime
1178615588 \-szBitRate                             "64 kbps" \-nDtmfDuration
100 \-szPeerCodecName                              "" \-szSilenceFile
"" \-bytesPerFrameBuffer                           "" \-groupBox_MOS1
false \-szPeerCodecDetails                          "" \-bMosOnMax
0 \-groupBox_JB1                                    false \-nMosInterval
3 \-nCompJitterBuffer                              50 \-bUseJitter
false \-szCodecName                                "G711ALaw" \-szPeerDtmfSeq
"" \-bLimitDtmf                                    true \-bUseMOS
false \-bJitMs                                      0 \-szCodecDescr
"ITU-T G.711 is a standard to represent 8 bit compressed pulse code modulation (PCM)
samples for signals of voice frequencies, sampled at the rate of 8000
samples/second. G.711 encoder will create a 64 Kbps bitstream. A-Law G.711 PCM
encoder converts 13 bit linear PCM samples into 8 bit compressed PCM (logarithmic
form) samples, and the decoder does the conversion vice versa." \-bCompMs
0 \-nDtmfStreams                                   10 \-packetTimeBuffer
"" \-szPowerLevel                                  "PL_20" \-szDtmfSeq
"12345" \-nCompJitterMs                             1000 \-nPeerDtmfInterdigits
0 \-bRtpStartCollector                             false \-nMosMaxStreams
1 \-szCodecDetails                                 "BF160PT20" \-nSessionType
0 \-bUseSilence                                    false \-bModifyPowerLevel
false \-bUseCompensation                           false$Activity_SIPServer1 agent.p-
m.contentOfMessages.config \-bFolding                false \-
bBestPerformance                                  1 \-szTO
"<sip:id\[50000-\]@IP>" \-bOptional                  false \-szCONTACT
"<sip:id\[50000-\]@IP>" \-bAdvisable                 false \-bCompact
false \-szFROM                                     "<sip:id\[50000-\]@IP>" \-
szREQUESTURI                                       "sip:IP" \-bScattered
false$Activity_SIPServer1 agent.pm.contentOfMessages.rulesTable.clear$Activity_
SIPServer1 agent.pm.stateMachine.config \-nActiveTimeout 0
\bUasStateless                                    false \-nActiveTimeoutValue
0 \-nTimersT4                                       5000 \-nTimersT1
500 \-nTimersT2                                    4000 \-nTimersTD
32000 \-nActiveTimeoutTU                            0 \-nTimersTC
180000$Activity_SIPServer1 agent.pm.videoSettings.config \-videoBitrate
128.0 \-videoBitrateLimit                          0$Activity_SIPServer1

```

```

agent.pm.scenarios.clear$Activity_SIPServer1 agent.pm.scenarios.appendItem \-id
"RECEIVEUSING180" \-bNextCommandIsDetect false \-szDummy10
"" \-isLastCmd false$Activity_SIPServer1 agent.p-
m.predefined_tos_for_rtp.clear$Activity_SIPServer1 agent.pm.predefined_tos_for_
rtp.appendItem \-id "TypeOfServiceForRTP" \-
tos_val_for_rtp "Best Effort (0x0)"$Activity_SIPServer1
agent.pm.predefined_tos_for_rtp.appendItem \-id
"TypeOfServiceForRTP" \-tos_val_for_rtp "Class 1
(0x20)"$Activity_SIPServer1 agent.pm.predefined_tos_for_rtp.appendItem \-id
"TypeOfServiceForRTP" \-tos_val_for_rtp "Class 2
(0x40)"$Activity_SIPServer1 agent.pm.predefined_tos_for_rtp.appendItem \-id
"TypeOfServiceForRTP" \-tos_val_for_rtp "Class 3
(0x60)"$Activity_SIPServer1 agent.pm.predefined_tos_for_rtp.appendItem \-id
"TypeOfServiceForRTP" \-tos_val_for_rtp "Class 4
(0x80)"$Activity_SIPServer1 agent.pm.predefined_tos_for_rtp.appendItem \-id
"TypeOfServiceForRTP" \-tos_val_for_rtp "Express Forwarding
(0xA0)"$Activity_SIPServer1 agent.pm.predefined_tos_for_rtp.appendItem \-id
"TypeOfServiceForRTP" \-tos_val_for_rtp "Control
(0xC0)"$Activity_SIPServer1 agent.pm.predefined_tos_for_rtp.appendItem \-id
"TypeOfServiceForRTP" \-tos_val_for_rtp "Best Effort
(0x0)"$Activity_SIPServer1 agent.pm.predefined_tos_for_sip.clear$Activity_SIPServer1
agent.pm.predefined_tos_for_sip.appendItem \-id
"TypeOfServiceForSIP" \-tos_val_for_sip "Best Effort
(0x0)"$Activity_SIPServer1 agent.pm.predefined_tos_for_sip.appendItem \-id
"TypeOfServiceForSIP" \-tos_val_for_sip "Class 1
(0x20)"$Activity_SIPServer1 agent.pm.predefined_tos_for_sip.appendItem \-id
"TypeOfServiceForSIP" \-tos_val_for_sip "Class 2
(0x40)"$Activity_SIPServer1 agent.pm.predefined_tos_for_sip.appendItem \-id
"TypeOfServiceForSIP" \-tos_val_for_sip "Class 3
(0x60)"$Activity_SIPServer1 agent.pm.predefined_tos_for_sip.appendItem \-id
"TypeOfServiceForSIP" \-tos_val_for_sip "Class 4
(0x80)"$Activity_SIPServer1 agent.pm.predefined_tos_for_sip.appendItem \-id
"TypeOfServiceForSIP" \-tos_val_for_sip "Express Forwarding
(0xA0)"$Activity_SIPServer1 agent.pm.predefined_tos_for_sip.appendItem \-id
"TypeOfServiceForSIP" \-tos_val_for_sip "Control
(0xC0)"$Activity_SIPServer1 agent.pm.predefined_tos_for_sip.appendItem \-id
"TypeOfServiceForSIP" \-tos_val_for_sip "Best Effort (0x0)"

```

**SEE ALSO**[ixNetTraffic](#)



## General Settings

General Settings—Sets the SIP server agent's general configuration options.

### SYNOPSIS

```
set Traffic2_Network2 [::IxLoad new ixNetTraffic]
set Activity_SIPServer1 [$Traffic2_Network2 activityList.appendItem options...]
$Activity_SIPServer1 agent.pm.generalSettings.config
```

### DESCRIPTION

A SIP server's advanced configuration options are set by modifying the options of the `pm.generalSettings` option of the SIP Server Agent object.

### SUBCOMMANDS

None.

### OPTIONS

The SIP server agent's General Settings options are the same as for the SIP client agent. See the SIP Client.

### EXAMPLE

```
$Activity_SIPServer1 agent.pm.generalSettings.config \-dhcpServerPort
5060 \-ipv6Form 0 \-bRemoveCredent
false \-bRegBefore false \-type_of_service_for_rtp
"Best Effort (0x0)" \-_gbDhcpServerPort false \-nUdpMaxSize
1024 \-regInterval 0 \-szAuthDomain
"domain\[0000-\]" \-vlan_priority_sip 0 \-useDhcp
false \-enableTosSIP false \-nUdpPort
5060 \-ipPreference 0 \-_gbIpPreference
false \-nPrefQop 0 \-szRegistrar
"127.0.0.1:5060" \-enableVlanPriority_for_sip false \-nTcpPort
5060 \-szTransport "UDP" \-szAuthPassword
"password\[0000-\]" \-type_of_service_for_sip "Best Effort (0x0)" \-
szAuthUsername "user\[0000-\]" \-enableTosRTP
false \-compressZeros false
```

### SEE ALSO

[SIP Server Agent](#)

## Content of Messages

Content of Messages—Specifies the content of the SIP messages sent by the server.

### SYNOPSIS

```
set Traffic2_Network2 [::IxLoad new ixNetTraffic]
set Activity_SIPServer1 [$Traffic2_Network2 activityList.appendItem options...]
$Activity_SIPServer1 agent.pm.contentOfMessages.config
```

### DESCRIPTION

A SIP server's advanced configuration options are set by modifying the options of the `pm.contentOfMessages` option of the `SIP Server Agent` object.

### SUBCOMMANDS

None.

### OPTIONS

The SIP server agent's Content of Messages options are the same as for the SIP client agent. See `Content of Messages`.

### SEE ALSO

[SIP Server Agent](#)

## State Machine

State Machine—Configures the SIP server agent’s internal timers and other parameters of its state machine.

### SYNOPSIS

```
set Traffic2_Network2 [::IxLoad new ixNetTraffic]
set Activity_SIPServer1 [$Traffic2_Network2 activityList.appendItem options...]
$Activity_SIPServer1 agent.pm.stateMachine.config
```

### DESCRIPTION

A SIP server’s state machine parameters are set by modifying the options of the `pm.StateMachine` option of the `SIP Server Agent` object.

### SUBCOMMANDS

None.

### OPTIONS

The SIP server agent’s State Machine options are the same as for the SIP client agent with one addition (below). See `Content of Messages`.

`bUasStateless`

If `true`, the SIP server behaves as a stateless User Agent Server (UAS).

A stateless UAS does not maintain transaction states. It replies to requests normally but discards any state that would ordinarily be retained by a UAS after a response has been sent.

If a stateless UAS receives a retransmission of a request, it regenerates the response and resends it, just as if it were replying to the first instance of the request. (Default = "0").

### EXAMPLE

```
$Activity_SIPServer1 agent.pm.stateMachine.config \-nActiveTimeout
0 \-bUasStateless false \-nActiveTimeoutValue
0 \-nTimersT4 5000 \-nTimersT1
500 \-nTimersT2 4000 \-nTimersTD
32000 \-nActiveTimeoutTU 0 \-nTimersTC
180000
```

### SEE ALSO

[SIP Server Agent](#)

## Media Settings

Media Settings—Selects and configures the streaming audio files for the multimedia session that the server will play over RTP.

### SYNOPSIS

```
set Traffic2_Network2 [::IxLoad new ixNetTraffic]
set Activity_SIPServer1 [$Traffic2_Network2 activityList.appendItem options...]
$Activity_SIPServer1 agent.pm.mediaSettings.config
```

### DESCRIPTION

A SIP server's advanced configuration options are set by modifying the options of the `pm.mediaSettings` option of the `SIP Server Agent` object.

### SUBCOMMANDS

None.

### OPTIONS

The SIP server agent's Media Settings options are the same as for the SIP client agent. See `Media Settings`.

### SEE ALSO

[SIP Server Agent](#)

## Scenarios

Scenarios—Creates the list of SIP commands that the server will send to a SIP server.

### SYNOPSIS

```
set Traffic2_Network2 [::IxLoad new ixNetTraffic]
set Activity_SIPServer1 [$Traffic2_Network2 activityList.appendItem options...]
$Activity_SIPServer1 agent.pm.scenarios.appendItem
```

### DESCRIPTION

A command is added to the Scenarios object using the `appendItem` subcommand from the `ixConfigSequenceContainer` command.

### SUBCOMMANDS

The options for this command are configured and read using the standard `config`, `cget`, and `getOption` subcommands defined in the `ixConfig` command.

### OPTIONS

`id`

SIP command to be executed. One of the following:

Command	Description
RECEIVEUSING180	Causes the SIP server to respond to an INVITE by returning a 180 (Ringing) response, which indicates that it is trying to alert the user. The 180 response is routed back through the proxies in the reverse direction.
RECEIVEUSING100AND180	Causes the SIP server to respond to an INVITE by first returning a 100 response, which indicates that the request has been received by the next-hop server and that some unspecified action is being taken on behalf of this call (for example, a database is being consulted). The server then responds with a 180 (Ringing) response, which indicates that it is trying to alert the user. The 180 response is routed back through the proxies in the reverse direction.
SEND6XX	Causes the SIP server to respond to an INVITE by first returning a 604 (Does not Exist Anywhere) response. 6xx-series responses are failure responses that indicate that the server has definitive information about a particular user, not just the particular instance indicated in the Request-URI.

VOICESESSION	<p>Plays one of the waveform audio files listed in the Audio Clips Pool on the Media Settings tab. The SIP <b>server sends the</b> file to the origin of the SIP call.</p> <p>Audio Pool File: Select one of the waveform audio files listed in the Audio Pool File on the Media Settings tab.</p> <p><b>Play:</b> Select this option if you want the SIP server to play the clip a fixed number of times. Configure the number of times in the field.</p> <p><b>Repeat Continuous for:</b> Select this option if you want the SIP server to play the clip continuously for some number of seconds, minutes, hours, or days. Select the units of time from the drop-down list, then configure the number of seconds, minutes, hours, or days that the clip will play in the field.</p>
--------------	--

### Arguments for id = RECEIVEUSING180

None.

### Arguments for id = RECEIVEUSING100AND180

None.

### Arguments for id = SEND6XX

None.

### Arguments for id = VOICESESSION

szAudioFile

Waveform audio file that will be played during the session. This must be an `szWaveName` object contained within the `Audio Clips Pool` object. (Default = "<None>").

nPlayMode

If `true`, the audio file plays for a fixed number of times. If `false`, the audio file plays continuously. (Default = "0").

nRepeatCount

If `nPlayMode` is `true`, this parameter sets the number of times that the audio file will play. (Default = "1").

nPlayTime

Length of time to play the audio file. Specify the units of time in the `nTimeUnit`.

nTimeUnit

Units of time used to set the audio file play time (`nPlayTime`). The choices are:

---

Value	Description
"0"	(default) <b>Seconds</b>
"1"	<b>Minutes</b>
"2"	<b>Hours</b>
"3"	<b>Days</b>

**EXAMPLE**

```
$Activity_SIPServer1 agent.pm.scenarios.appendItem \-id  
"RECEIVEUSING180" \-bNextCommandIsDetect           false \-szDummy10  
"" \-isLastCmd                                     false
```

**SEE ALSO**

SIP Client Agent

## Using Variables in SIP Fields

You can insert variables into various fields on the SIP client tabs, such as the `Username`, `Password`, and `Domain` fields on the SIP client General Settings tab and the `Userinfo` (header) fields on the Content of Messages. You can use the variables to generate large numbers of unique user names, passwords, and domain names or header fields.

You can use the following variables:

- Numbers 0-9
- Letters A-Z and a-z

The letter variables are case-sensitive; IxLoad considers the variable strings "AA" and "aa" to be different.

You can combine the variables with fixed text to create the user names, passwords, and domain names. For example, you can enter `user[00-]` to create a range of unique user names that begin with the characters "user" (user00, user01, and so on).

To insert the variables into a field, enclose them in square brackets ( `[ ]` ). To specify a range, separate the minimum and maximum values with a hyphen (-). For example, `[00-10]` specifies a range of 00 through 10.

The number of variables you insert determines the width of the generated strings. For example, the variable "00" can generate the strings 00 - 99. The variable string "000" can generate the strings 000 - 999.

Similarly, "AA" can generate strings that consist of all the two-letter combinations from AA to ZZ. "AAA" can generate strings that consist of all the three letter combinations from AAA to ZZZ.

You can use a single variable string and allow IxLoad to generate strings up the maximum value of the string, or you can use two variable strings together to restrict the generated strings to a certain range.

See the following example:

`[0- ]` will generate all the values 0 - 9 (0, 1, 2, 3 . . . 9).

`[0-5]` will generate all the values 0 - 5.

`[00- ]` will generate all the values 00 - 99 (00, 01, 02, 03. . .97, 98, 99).

`[00-50]` will generate all the values 0 - 50.

`[A- ]` will generate all the values A - Z (A, B, C . . . Z).

`[A-K]` will generate all the values A - K.

`[AA- ]` will generate all the values AA - ZZ (AA, AB, AC. . ZX, ZY, ZZ).

`[AA-KK]` will generate all the values AA - KK.

When IxLoad has generated the final string, if the test configuration requires additional strings, IxLoad returns to the starting value of the variable and continues to generate strings until no more are required. In this case, the generated strings will not be unique.

For example, if a SIP test requires 256 user names and the `Username` field is configured as:



## User[00-]

IxLoad generates the strings User00 - User99, then repeats and again generates strings User00 - User99, then generates the final group of strings User00 - User56.

IxLoad generates the SIP `Username`, `Password`, and `Domain` fields simultaneously and associates one value from each to form each user name–password– domain combination used in the test.

For example, the first generated user name will be associated with the first generated password and the first generated domain. The second generated user name will be associated with the second generated password and the second generated domain, and so on until all the necessary strings have been generated.

If a SIP `Username`, `Password`, and `Domain` fields contain variables while the remaining fields contain a fixed value (no variable), IxLoad associates the identical value from the fixed field to all the generated values.

See the following example:

Field Values	Associated Strings
Username = User[00-] Password = Pass[AZ-] Domain = Domain[az-]	User00 + PassAA + Domainaa User01 + PassAB + Domainab User02 + PassAC + Domainac . . .
Username = User[00-] Password = Pass[AZ-] Domain = MyDomain	User00 + PassAA + MyDomain User01 + PassAB + MyDomain User02 + PassAC + MyDomain . . .
Username = User[00-] Password = Pass Domain = MyDomain	User00 + Pass + MyDomain User01 + Pass + MyDomain User02 + Pass + MyDomain . . .

## Bulk SIP Statistics

For the Bulk SIP statistics, see the following:

[Bulk SIP Client Statistics](#)

[Bulk SIP Server Statistics](#)

For TCP statistics, see TCP, Run State, and Curve Segment Statistics.

Statistics in the results files and reports are averaged over all ports. If a statistic for an interval is missing, IxLoad interpolates it from the statistic immediately prior to it and the statistic after it.

The test results are available from the location defined on the User Directories window. See User Directories.

## Bulk SIP Client Statistics

The table below lists the Bulk SIP Client Statistics.

Statistic	Description
<b>Call-related Statistics</b>	
SIP calls initiated	Number of SIP calls initiated.
SIP calls completed	Number of SIP calls established.
SIP calls active	Number of SIP calls active.
<b>Transaction-related Statistics</b>	
SIP INVITE client transactions initiated	Number of SIP INVITE transactions initiated by the client.
SIP INVITE client transactions succeeded	Number of INVITE transactions initiated by the client that succeeded.
SIP INVITE client transactions failed	Number of INVITE transactions initiated by the client that failed for all reasons.
SIP INVITE client transactions failed (TIMER B)	Number of INVITE transactions initiated by the client that failed because Timer B (transaction timeouts timer) expired.
SIP INVITE client transactions failed (TRANSPORT ERROR)	Number of INVITE transactions initiated by the client that failed due to TCP or UDP errors.
SIP INVITE client transactions failed (TRANSACTION TIMEOUT TIMER)	Number of INVITE transactions initiated by the client that failed because the transaction timeout timer expired.
SIP INVITE client transactions failed (5xx)	Number of INVITE transactions initiated by the client that failed due to 5xx-series (server error) errors.
SIP NON-INVITE client transactions initiated	Number of SIP NON-INVITE transactions initiated by the client.
SIP NON-INVITE client transactions succeeded	Number of SIP NON-INVITE transactions initiated by the client that succeeded.
SIP NON-INVITE client transactions failed	Number of SIP NON-INVITE transactions initiated by the client that failed.

SIP NON-INVITE client transactions failed (TIMER F)	Number of NON-INVITE transactions initiated by the client that failed because Timer F (non-INVITE transaction timeout timer) expired.
SIP NON-INVITE client transactions failed (TRANSPORT ERROR)	Number of NON-INVITE transactions initiated by the client that failed due to TCP or UDP errors.
<b>Message-related Statistics</b>	
SIP INVITE requests sent	Number of SIP INVITE messages sent by the client.
SIP ACK requests sent	Number of SIP ACK messages sent by the client.
SIP BYE requests sent	Number of SIP BYE messages sent by the client.
SIP REGISTER requests sent	Number of SIP REGISTER messages sent by the client.
SIP INVITE messages retransmitted	Number of INVITE messages initiated by the client that had to be re-transmitted.
SIP NON-INVITE requests retransmitted	Number of NON-INVITE transactions initiated by the client that had to be re-transmitted.
SIP INVITE requests unexpected	Number of SIP INVITE requests that the client did not expect to receive.
SIP ACK requests unexpected	Number of SIP ACK requests that the client did not expect to receive.
SIP BYE requests unexpected	Number of SIP BYE requests that the client did not expect to receive.
SIP CANCEL requests unexpected	Number of SIP CANCEL requests that the client did not expect to receive.
SIP UNKNOWN messages unexpected	Number of SIP UNKNOWN messages that the client did not expect to receive.
SIP UNKNOWN requests unexpected	Number of SIP UNKNOWN requests that the client did not expect to receive.
SIP 1xx responses expected	Number of SIP 1xx-series responses the client received that it expected.

SIP 1xx responses unexpected	Number of SIP 1xx-series responses the client received that it did not expect.
SIP 2xx responses expected	Number of SIP 2xx-series responses the client received that it expected.
SIP 2xx responses unexpected	Number of SIP 2xx-series responses the client received that it did not expect.
SIP 3xx responses expected	Number of SIP 3xx-series responses the client received that it expected.
SIP 3xx responses unexpected	Number of SIP 3xx-series responses the client received that it did not expect.
SIP 4xx responses expected	Number of SIP 4xx-series responses the client received that it expected.
SIP 4xx responses unexpected	Number of SIP 4xx-series responses the client received that it did not expect.
SIP 5xx responses expected	Number of SIP 5xx-series responses the client received that it expected.
SIP 5xx responses unexpected	Number of SIP 5xx-series responses the client received that it did not expect.
SIP 6xx responses expected	Number of SIP 6xx-series responses the client received that it expected.
SIP 6xx responses unexpected	Number of SIP 6xx-series responses the client received that it did not expect.
<b>RTP: Global Stream Transmit Statistics</b>	
RTP Bytes Sent	Total number of bytes sent, including header and payload.
RTP Packets Sent	Total number of packets sent.
RTP Tx Jitter (ns)	Average amount of transmit jitter, in nanoseconds.
RTP Tx Packets Dropped	Number of packets transmitted by the client that were dropped.
<b>RTP: Global Stream Statistics</b>	
RTP Dropped Packets	Number of RTP packets dropped.
RTP Bytes Received	Number of RTP bytes received.

---

RTP Packets Received	Number of RTP packets received.
RTP Payload Bytes Received	Number bytes received in RTP payloads.
RTP Bad Packets Received	Number of defective RTP packets received.
RTP Lost Packets	Number of packets lost.
RTP Misordered Packets Received	Number of packets received out of order.
RTP Duplicate Packets Received	Number of duplicate packets received.
RTP Jitter Min	Smallest amount of jitter detected.
RTP Jitter Max	Largest amount of jitter detected.
RTP Packets With Jitter Up To 1ms	Packets received with jitter of up to 1ms.
RTP Packets With Jitter Up To 3ms	Packets received with jitter of 1-3ms.
RTP Packets With Jitter Up To 5ms	Packets received with jitter of 3-5ms.
RTP Packets With Jitter Up To 10ms	Packets received with jitter of 5-10ms.
RTP Packets With Jitter Up To 20ms	Packets received with jitter of 10-20ms
RTP Packets With Jitter Up To 40ms	Packets received with jitter of 20-40ms
RTP Packets With Jitter More Than 40ms	Packets received with jitter of more than 40ms.
RTP DTMF Digits Detected	Total number of path confirmation DTMF tone sequences received.

RTP DTMF Digits Matched	Number of DTMF sequences received that matched the sequence specified on the Detect DTMF command. This statistic is not related to the option to perform path confirmation using DTMF digits.
RTP DTMF Digits Not Matched	Number of DTMF sequences received that did not match the sequence specified on the Detect DTMF command. This statistic is not related to the option to perform path confirmation using DTMF digits.
RTP Good DTMF Sequences Detected	Total number of correct path confirmation DTMF tone sequences received.
RTP Bad DTMF Sequences Detected	Total number of incorrect path confirmation DTMF tone sequences received.
RTP DTMF Detection Timeout	Number of DTMF detection attempts (by the Detect DTMF command) that ended because one of the timeout timers expired.
RTP DTMF Digits Sent	Number of DTMF digits sent by Generate DTMF commands. This statistic is not related to the option to perform path confirmation using DTMF digits.
RTP DTMF Sequences Sent	Number of DTMF sequences sent by Generate DTMF commands. This statistic is not related to the option to perform path confirmation using DTMF digits.
RTP MF Digits Sent	Number of MF digits sent by Generate MF commands.
RTP MF Sequences Sent	Number of MF sequences sent by Generate MF commands.
RTP Custom Tones Sent	Number of custom tones sent by Generate Tone commands.
RTP Packets Dropped By Jitter Buffer	Number of packet dropped from the jitter buffer because they arrived later than expected.
<b>Note:</b> In the CSV files, global MOS scores are represented as whole numbers (for example, "345"); in StatViewer (they are represented as floating-point numbers (for example, "3.45").	
RTP MOS Average Instant	Average MOS score at the time of the sampling interval.
RTP MOS Worst Instant	Lowest MOS score at the time of the sampling interval.
RTP MOS Best Instant	Highest MOS score at the time of the sampling interval.
RTP MOS Worst	Lowest MOS score recorded during the test.

RTP MOS Best	Highest MOS score recorded during the test.
RTP MOS Average Per Call	Average MOS score per call.
RTP MOS Worst Per Call	Lowest MOS score per call.
RTP MOS Best Per Call	Highest MOS score per call.
RTP Calls With Continuous Path Confirmation	Number of calls on which path confirmation continued throughout the call.
RTP Calls With Interrupted Path Confirmation	Number of calls on which path confirmation was interrupted during the call.
RTP Calls Without Path Confirmation	Number of calls on which there was no path confirmation.
<b>Transport Statistics</b>	
SIP Bytes Transmitted	Total number of SIP bytes transmitted.
SIP Bytes Received	Total number of SIP bytes received.
SIP Signaling UDP Packets Transmitted	Number UDP packets transmitted for SIP signaling purposes.
SIP Signaling UDP Packets Received	Number UDP packets received for SIP signaling purposes.
<b>Per-Stream Statistics</b>	
RTP Path Confirmation Status	Status of path confirmation on the stream. Note for Tcl API users: For this statistic, use the Aggregation Type <i>kString</i> .
RTP MOS	Average MOS score recorded on the stream.
RTP Worst MOS	Lowest MOS score recorded on the stream.
RTP Best MOS	Highest MOS score recorded on the stream.
RTP Bytes	Number of bytes transmitted on the stream.
RTP Packets	Number of packets transmitted on the stream.
RTP Bad Packets	Number of bad packets transmitted on the stream.



RTP Lost Packets	Number of packets lost on the stream.
RTP Missorder Packets	Number of packets received out of order on the stream.
RTP Duplicate Packets	Number of duplicate packets received on the stream.
RTP Packets With Jitter Up To 1ms	Number of packets received on the stream with jitter up to 1 millisecond.
RTP Packets With Jitter Up To 3ms	Number of packets received on the stream with jitter up to 3 milliseconds.
RTP Packets With Jitter Up To 5ms	Number of packets received on the stream with jitter up to 5 milliseconds.
RTP Packets With Jitter Up To 10ms	Number of packets received on the stream with jitter up to 10 milliseconds.
RTP Packets With Jitter Up To 20ms	Number of packets received on the stream with jitter up to 20 milliseconds.
RTP Packets With Jitter Up To 40ms	Number of packets received on the stream with jitter up to 40 milliseconds.
RTP Packets With Jitter More Than 40ms	Number of packets received on the stream with jitter over 40 milliseconds.
RTP Average Jitter (ns)	Average jitter, in nanoseconds.
RTP Min Jitter (ns)	Lowest jitter recorded, in nanoseconds.
RTP Max Jitter (ns)	Largest jitter recorded, in nanoseconds.
RTP DTMFs Detected	Total number of path confirmation DTMF tone sequences sent.
RTP DTMFs Matched	Number of DTMF sequences received that matched the sequence specified on the Detect DTMF command. This statistic is not related to the option to perform path confirmation using DTMF digits.
RTP DTMFs Not Matched	Number of DTMF sequences received that did not match the sequence specified on the Detect DTMF command. This statistic is not related to the option to perform path confirmation using DTMF digits.
RTP Good DTMF Sequences Detected	Total number of correct path confirmation DTMF tone sequences received.

RTP Bad DTMF Sequences Detected	Total number of incorrect path confirmation DTMF tone sequences received.
RTP DTMF Detection Timeout	Number of DTMF detection attempts (by the Detect DTMF command) that ended because one of the timeout timers expired.
RTP DTMF Digits Sent	Number of DTMF digits sent by Generate DTMF commands. This statistic is not related to the option to perform path confirmation using DTMF digits.
RTP DTMF Sequences Sent	Number of DTMF sequences sent by Generate DTMF commands. This statistic is not related to the option to perform path confirmation using DTMF digits.
RTP MF Digits Sent	Number of MF digits sent by Generate MF commands.
RTP MF Sequences Sent	Number of MF sequences sent by Generate MF commands.
RTP Custom Tones Sent	Number of custom tones sent by Generate Tone commands.
RTP Packets Dropped By Jitter Buffer	Total number of packets dropped from the jitter buffer because they were received late.
<b>Video Statistics</b>	
Video Total Bytes Sent	Total video bytes sent by the server.
Video Total Packets Sent	Total video packets sent by the server.
Video Tx Jitter (ns)	Variation in video packet transmission times, in nanoseconds.
Video Tx Packets Dropped	Number of video packets dropped before transmission.
<b>Video Global Stream Statistics</b>	

Video Frame Stats Disabled	<p>Initially, this statistic displays no value.</p> <p>If the received data rate exceeds the cut-off threshold, IxLoad stops computing the I-, P-, and B-frame statistics and this statistic will display "YES".</p> <p>The value will remain YES until the end of the iteration. Once frame statistics computation is disabled during a run, it remains disabled throughout the remainder of the run.</p> <p>Prior to starting the next run (or the next iteration of the same test), this statistic will be cleared and IxLoad will again begin computing the frame statistics. It will continue to compute the frame statistics as long as the bit rate remains below the cut-off threshold.</p> <p>Note for Tcl API users: For this statistic, use the Aggregation Type <i>kString</i>.</p>
Video Quality Metrics Disabled	<p>Initially, this statistic displays no value.</p> <p>If the received data rate exceeds the cut-off threshold, IxLoad stops computing the Quality Metrics, and this statistic will display "YES".</p> <p>The value will remain YES until the end of the iteration. Once the Quality Metrics computation is disabled during a run, it remains disabled throughout the remainder of the run.</p> <p>Prior to starting the next run (or the next iteration of the same test), this statistic will be cleared and IxLoad will again begin computing the Quality Metrics. It will continue to compute the metrics as long as the bit rate remains below the cut-off threshold.</p> <p>Note for Tcl API users: For this statistic, use the Aggregation Type <i>kString</i>.</p>
Video Total Bytes Rcvd	Total number of video bytes received by the client.
Video Total packets Rcvd	Total number of video packets received by the client.
Video Total Loss	Total number video packets lost.
Video Unexpected UDP Packets Received	Number of UDP video packets received packets during a time when no channels are active.
Video Overload Packets Dropped	Number of RTP video packets dropped because a port did not have enough computing power to process them.
Video Total RTP Packets Lost	Total number of RTP video packets lost while using RTP over UDP transport.
Video Total Out Of Order RTP Packets	Total number of RTP video packets received in the wrong order while using RTP over UDP transport.

Video Total Duplicate RTP Packets	Total number of duplicate video RTP packets received.
Video Global Jitter	Average variation in arrival times of video packets on all streams. Note for Tcl API users: This is a weighted statistic. If you are using this statistic in a Tcl script, use the <i>kWeightedAverage</i> aggregation type.
Video Jitter less than 50 us	Number of video packets received with 0 to 50 microseconds of jitter.
Video Jitter between 50 - 100 us	Number of video packets received with 50 to 100 microseconds of jitter.
Video Jitter between 100 - 500 us	Number of video packets received with 100 -500 microseconds of jitter.
Video Jitter between 500 us - 2 ms	Number of video packets received with 500 microseconds to 2 milliseconds of jitter.
Video Jitter between 2 - 5 ms	Number of video packets received with 2 to 5 milliseconds of jitter.
Video Jitter between 5 - 10 ms	Number of video packets received with 5 to 10 milliseconds of jitter.
Video Jitter greater than 10 ms	Number of video packets received with more than 10 milliseconds of jitter.
Video Inter Packet Arrival Time between 0 - 2 ms	Number of video packets that arrived less than 2 milliseconds after the preceding packet was received.
Video Inter Packet Arrival Time between 2 - 5 ms	Number of video packets that arrived between 2 and 5 milliseconds after the preceding packet was received.
Video Inter Packet Arrival Time between 5 - 10 ms	Number of video packets that arrived between 5 and 10 milliseconds after the preceding packet was received.
Video Inter Packet Arrival Time between 10 - 25 ms	Number of video packets that arrived between 10 and 25 milliseconds after the preceding packet was received.
Video Inter Packet Arrival Time between 25 - 50 ms	Number of video packets that arrived between 25 and 50 milliseconds after the preceding packet was received.

Video Inter Packet Arrival Time between 50 - 100 ms	Number of video packets that arrived between 50 and 100 milliseconds after the preceding packet was received.
Video Inter Packet Arrival Time between 100 - 200 ms	Number of video packets that arrived between 100 and 200 milliseconds after the preceding packet was received.
Video Inter Packet Arrival Time between 200 - 500 ms	Number of video packets that arrived between 200 and 500 milliseconds after the preceding packet was received.
Video Inter Packet Arrival Time greater than 500 ms	Number of video packets that arrived more than 500 milliseconds after the preceding packet was received.
<b>Video Per-Stream Statistics</b>	
Video Active	Indicates whether the video stream is active or not: 0 = inactive 1 = active Note for Tcl API users: For this statistic, use the Aggregation Type <i>kString</i> .
Video Stream Name	Name of video stream. Note for Tcl API users: For this statistic, use the Aggregation Type <i>kString</i> .
Video Flow ID	Number identifying the flow used by the video stream. A flow consists of the packets flowing between a source IP:port and a destination IP:port. Note for Tcl API users: For this statistic, use the Aggregation Type <i>kString</i> .
Video Transport	Type of transport used on the video stream. Note for Tcl API users: For this statistic, use the Aggregation Type <i>kString</i> .
Video Codec	Video codec used on the video stream. Note for Tcl API users: For this statistic, use the Aggregation Type <i>kString</i> .
Video Stream Bit Rate	Bit rate used on video stream.
Video MDI-DF	Media Delay Index Delay Factor (MDI-DF) experienced on video stream.

Video MIN MDI-DF	Smallest MDI Delay Factor experienced on video stream.
Video MAX MDI-DF	Largest MDI Delay Factor experienced on video stream.
Video AVG-MDI-DF	Average MDI Delay Factor experienced on video stream.
Video MDI-MLR	Media Delay Index Media Loss Rate experienced on video stream.
Video Bytes	Number of bytes received on the video stream.
Video I Frames Rcvd	Number of I-frames received on the video stream. An I-frame is encoded with no reference to any previous or subsequent frames.
Video P Frames Rcvd	Number of P-frames received on the video stream. A P-frame is encoded relative to the previous reference frame.
Video B Frames Rcvd	Number of B-frames received on the video stream. A B-frame is encoded relative to the previous reference frame, the subsequent reference frame, or both
Video Packets	Number of packets received on the video stream.
Video Loss	Number of packets lost on the video stream.
Video Jitter	Number of packets with jitter received on the video stream.
Video Inter Pkt Arrival Time	Amount of time between received video packets, in milliseconds.
Video Min Inter Pkt Arrival Time	Smallest amount of time between received video packets, in milliseconds.
Video Max Inter Pkt Arrival Time	Largest amount of time between received video packets, in milliseconds.
Video Packet Latency (ns)	Average packet latency on the video stream.
Video Min Packet Latency (ns)	Smallest packet latency on the video stream.
Video Max Packet Latency (ns)	Longest packet latency on the video stream.

Video Join Latency (ms)	Amount of time, in milliseconds, elapsed between the time the client sent an IGMP JOIN (broadcast channel) or RTSP PLAY (VoD channel) and the time it received the first byte of video data.
Video I Join Latency (ms)	Amount of time, in milliseconds, elapsed between the time the client sent an IGMP JOIN (broadcast channel) or RTSP PLAY (VoD channel) and the time it received the first I frame. This statistic is computed for MPEG2 transport streams carrying MPEG2 video data.
Video Leave Latency (ms)	Amount of time, in milliseconds, elapsed between the time the client sent an IGMP LEAVE (broadcast channel) or RTSP PAUSE (VoD channel) and the time it received the last byte of video data. Leave latency has a maximum timeout of 10 seconds; if the client continues to receive data 10 seconds after it has sent the Leave command, the latency is measured as 10 seconds.
Video Channel Switch Latency	Amount of time, in milliseconds, elapsed between the time the client sent an IGMP LEAVE (broadcast channel) or RTSP PAUSE (VoD channel) to stop receiving one video stream and the time it received the first byte of data of a new video stream.
Video Channel Gap Duration	Amount of time, in milliseconds, elapsed between the time the client sent an IGMP LEAVE (broadcast channel) and received the last byte of the old video stream and the time it received the first byte of data of a new video stream.
Video Channel Overlap Duration	Amount of time, in milliseconds, elapsed after sending an IGMP LEAVE (broadcast channel) that the client was simultaneously receiving both the old and new video streams.
Video Control Sent	Indicates the type of video control command that has most recently been sent: 0 = LEAVE or PAUSE/TEARDOWN sent 1 = JOIN or PLAY sent
Video Data Rcvd	Indicates whether or not video data is being received: 0 = no data received 1 = data received
Video RTP Packets Lost	Number of RTP video packets lost.
Video RTP Packets Out of Order	Number of RTP video packets received out of order.

Video RTP Packets Duplicated	Number of duplicate RTP video packets received.
<b>Video Quality Statistics</b>	
Video JB Packets Accepted	Number of video packets accepted into the jitter buffer.
Video JB Packets Early	Number of video packets that arrived earlier than expected in the jitter buffer.
Video JB Packets Discarded	Total number of video packets that were discarded. This statistic is the total of: JB Packets Discarded (Underrun) and JB Packets Discarded (Overrun).
Video JB Packets Discarded (Underrun)	Number of video packets discarded because they arrived after their expected time slot.
Video JB Packets Discarded (Overrun)	Number of video packets discarded because the jitter buffer was full.
Video MOS_V	Mean Opinion Score for Video. This score is computed from the Video Service Quality statistic to create a zero-to-five (0-5) assessment of the quality of the video stream.
Video Service Quality	A factor in the range from 0 to 120, which provides an assessment of the capability of the RTP channel to support video transmission.
Video Gap Video Service Quality	Video Service Quality during the Gap state. This statistic is cumulative, and is reset to zero (0) whenever you join or pause the channel/stream (Multicast/VOD mode) or change to the channel/stream (Broadcast mode).
Video Burst Video Service Quality	Video Service Quality during the Burst state. This statistic is cumulative, and is reset to zero (0) whenever you join or pause the channel/stream (Multicast/VOD mode) or change to the channel/stream (Broadcast mode).
Video Burst Count	Number of times the stream entered the Burst state. This statistic is cumulative, and is reset to zero (0) whenever you join or pause the channel/stream (Multicast/VOD mode) or change to the channel/stream (Broadcast mode).



Video Avg Gap Len (Pkts)	<p>The average gap length, in packets.</p> <p>This statistic is cumulative, and is reset to zero (0) whenever you join or pause the channel/stream (Multicast/VOD mode) or change to the channel/stream (Broadcast mode).</p>
Video Avg Burst Len (Pkts)	<p>The average burst length, in packets.</p> <p>This statistic is cumulative, and is reset to zero (0) whenever you join or pause the channel/stream (Multicast/VOD mode) or change to the channel/stream (Broadcast mode).</p>
Video Degradation (Loss)	<p>The amount of the overall video quality degradation that can be attributed to packet loss.</p> <p>This statistic is cumulative, and is reset to zero (0) whenever you join or pause the channel/stream (Multicast/VOD mode) or change to the channel/stream (Broadcast mode).</p>
Video Degradation (Discard)	<p>The amount of the overall video quality degradation that can be attributed to packets being discarded from the jitter buffer.</p> <p>This statistic is cumulative, and is reset to zero (0) whenever you join or pause the channel/stream (Multicast/VOD mode) or change to the channel/stream (Broadcast mode).</p>
Video Degradation (Video Codec)	<p>The amount of the overall quality degradation that can be attributed to video codec selection.</p> <p>This statistic is cumulative, and is reset to zero (0) whenever you join or pause the channel/stream (Multicast/VOD mode) or change to the channel/stream (Broadcast mode).</p>
Video Current JB Packets Accepted	Number of video packets accepted into the jitter butter during the current statistics Update Interval.
Video Current JB Packets Discarded	Number of video packets discarded from the jitter butter during the current statistics Update Interval.
Video Current JB Packets Lost	Number of video packets lost during the current statistics Update Interval.
Video Current Video Service Quality	Video Service Quality during the current statistics update interval.

## Bulk SIP Server Statistics

The table below lists the Bulk SIP Server Statistics.

Statistic	Description
<b>Call-related Statistics</b>	
SIP calls received	Number of SIP calls received.
SIP calls completed	Number of SIP calls completed.
SIP calls active	Number of SIP calls active.
<b>Transaction-related Statistics</b>	
SIP INVITE server transactions received	Number of INVITE transactions received by the server.
SIP INVITE server transactions succeeded	Number of INVITE transactions received by the server that succeeded.
SIP INVITE server transactions failed	Number of INVITE transactions received by the server that failed for all reasons.
SIP INVITE server transactions failed (TIMER H)	Number of INVITE transactions initiated by the server that failed because Timer H (wait time for ACK receipt) expired.
SIP INVITE server transactions failed (TRANSPORT ERROR)	Number of INVITE transactions initiated by the server that failed due to TCP or UDP errors.
SIP NON-INVITE server transactions received	Number of NON-INVITE transactions received by the server.
SIP NON-INVITE server transactions succeeded	Number of SIP NON-INVITE transactions initiated by the server that succeeded.
SIP NON-INVITE server transactions failed	Number of SIP NON-INVITE transactions initiated by the server that failed.
<b>Message-related Statistics</b>	
SIP NON-INVITE requests retransmitted	Number of NON-INVITE requests that were re-transmitted.
SIP REGISTER Requests sent	Number of REGISTER requests sent.

SIP 1xx responses expected	Number of 100-series responses that the server expected to receive.
SIP 2xx responses expected	Number of 200-series responses that the server expected to receive.
SIP 3xx responses expected	Number of 300-series responses that the server expected to receive.
SIP 4xx responses expected	Number of 400-series responses that the server expected to receive.
SIP 5xx responses expected	Number of 500-series responses that the server expected to receive.
SIP 6xx responses expected	Number of 600-series responses that the server expected to receive.
SIP 300-699 responses retransmitted	Number of 3xx- to 6xx-series responses that had to be retransmitted by the server.
SIP INVITE requests expected	Number of INVITE requests that the server expected to receive.
SIP ACK requests expected	Number of ACK requests that the server expected to receive.
SIP BYE requests expected	Number of BYE requests that the server expected to receive.
SIP 1xx responses sent	Number of 1xx-series responses sent by the server.
SIP 1xx responses unexpected	Number of 1xx-series responses sent by the server that it did not expect to send.
SIP 2xx responses sent	Number of 2xx-series responses sent by the server.
SIP 2xx responses unexpected	Number of 2xx-series responses sent by the server that it did not expect to send.
SIP 3xx responses sent	Number of 3xx-series responses sent by the server.
SIP 3xx responses unexpected	Number of 3xx-series responses sent by the server that it did not expect to send.
SIP 4xx responses sent	Number of 4xx-series responses sent by the server.
SIP 4xx responses unexpected	Number of 4xx-series responses sent by the server that it did not expect to send.

SIP 5xx responses sent	Number of 5xx-series responses sent by the server.
SIP 5xx responses unexpected	Number of 5xx-series responses sent by the server that it did not expect to send.
SIP 6xx responses sent	Number of 6xx-series responses sent by the server.
SIP 6xx responses unexpected	Number of 6xx-series responses sent by the server that it did not expect to send.
SIP INVITE requests unexpected	Number of SIP INVITE requests that the server did not expect to receive.
SIP ACK requests unexpected	Number of SIP ACK requests that the server did not expect to receive.
SIP BYE requests unexpected	Number of SIP BYE requests that the server did not expect to receive.
SIP CANCEL requests unexpected	Number of SIP CANCEL requests that the server did not expect to receive.
SIP UNKNOWN requests unexpected	Number of SIP requests that the server did not expect to receive.
SIP UNKNOWN messages unexpected	Number of SIP messages that the server sent that it did not expect to send.
<b>RTP: Global Stream Transmit Statistics</b>	
RTP Bytes Sent	Total number of bytes sent, including header and payload.
RTP Packets Sent	Total number of packets sent.
RTP Tx Jitter (ns)	Average amount of transmit jitter, in nanoseconds.
RTP Tx Packets Dropped	Number of packets transmitted by the client that were dropped.
<b>RTP: Global Stream Statistics</b>	
RTP Dropped Packets	Number of RTP packets dropped.
RTP Bytes Received	Number of RTP bytes received.
RTP Packets Received	Number of RTP packets received.
RTP Payload Bytes Received	Number bytes received in RTP payloads.

RTP Bad Packets Received	Number of defective RTP packets received.
RTP Lost Packets	Number of packets lost.
RTP Misordered Packets Received	Number of packets received out of order.
RTP Duplicate Packets Received	Number of duplicate packets received.
RTP Jitter Min	Smallest amount of jitter detected.
RTP Jitter Max	Largest amount of jitter detected.
RTP Packets With Jitter Up To 1ms	Packets received with jitter of up to 1ms.
RTP Packets With Jitter Up To 3ms	Packets received with jitter of 1-3ms.
RTP Packets With Jitter Up To 5ms	Packets received with jitter of 3-5ms.
RTP Packets With Jitter Up To 10ms	Packets received with jitter of 5-10ms.
RTP Packets With Jitter Up To 20ms	Packets received with jitter of 10-20ms
RTP Packets With Jitter Up To 40ms	Packets received with jitter of 20-40ms
RTP Packets With Jitter More Than 40ms	Packets received with jitter of more than 40ms.
RTP DTMFs Detected	Total number of path confirmation DTMF tone sequences sent.
RTP DTMFs Matched	Number of DTMF sequences received that matched the sequence specified on the Detect DTMF command. This statistic is not related to the option to perform path confirmation using DTMF digits.
RTP DTMFs Not Matched	Number of DTMF sequences received that did not match the sequence specified on the Detect DTMF command. This statistic is not related to the option to perform path confirmation using DTMF digits.

RTP Good DTMF Sequences Detected	Total number of correct path confirmation DTMF tone sequences received.
RTP Bad DTMF Sequences Detected	Total number of incorrect path confirmation DTMF tone sequences received.
RTP DTMF Detection Timeout	Number of DTMF detection attempts (by the Detect DTMF command) that ended because one of the timeout timers expired.
RTP DTMF Digits Sent	Number of DTMF digits sent by Generate DTMF commands. This statistic is not related to the option to perform path confirmation using DTMF digits.
RTP DTMF Sequences Sent	Number of DTMF sequences sent by Generate DTMF commands. This statistic is not related to the option to perform path confirmation using DTMF digits.
RTP MF Digits Sent	Number of MF digits sent by Generate MF commands.
RTP MF Sequences Sent	Number of MF sequences sent by Generate MF commands.
RTP Custom Tones Sent	Number of custom tones sent by Generate Tone commands.
RTP Packets Dropped By Jitter Buffer	Number of packet dropped from the jitter buffer because they arrived later than expected.
<b>Note:</b> In the CSV files, global MOS scores are represented as whole numbers (for example, "345"); in StatViewer (they are represented as floating-point numbers (for example, "3.45").	
RTP MOS Average Instant	Average MOS score at the time of the sampling interval.
RTP MOS Worst Instant	Lowest MOS score at the time of the sampling interval.
RTP MOS Best Instant	Highest MOS score at the time of the sampling interval.
RTP MOS Worst	Lowest MOS score recorded during the test.
RTP MOS Best	Highest MOS score recorded during the test.
RTP MOS Average Per Call	Average MOS score per call.
RTP MOS Worst Per Call	Lowest MOS score per call.
RTP MOS Best Per Call	Highest MOS score per call.

RTP Calls With Continuous Path Confirmation	Number of calls on which path confirmation continued throughout the call.
RTP Calls With Interrupted Path Confirmation	Number of calls on which path confirmation was interrupted during the call.
RTP Calls Without Path Confirmation	Number of calls on which there was no path confirmation.
<b>Transport Statistics</b>	
SIP Bytes Transmitted	Total number of SIP bytes transmitted.
SIP Bytes Received	Total number of SIP bytes received.
SIP Signaling UDP Packets Transmitted	Number UDP packets transmitted for SIP signaling purposes.
SIP Signaling UDP Packets Received	Number UDP packets received for SIP signaling purposes.
<b>Per-Stream Statistics</b>	
RTP Path Confirmation Status	Status of path confirmation on the stream. Note for Tcl API users: For this statistic, use the Aggregation Type <i>kString</i> .
RTP MOS	Average MOS score recorded on the stream.
RTP Worst MOS	Lowest MOS score recorded on the stream.
RTP Best MOS	Highest MOS score recorded on the stream.
RTP Bytes	Number of bytes transmitted on the stream.
RTP Packets	Number of packets transmitted on the stream.
RTP Bad Packets	Number of bad packets transmitted on the stream.
RTP Lost Packets	Number of packets lost on the stream.
RTP Missorder Packets	Number of packets received out of order on the stream.
RTP Duplicate Packets	Number of duplicate packets received on the stream.
RTP Packets With Jitter Up To 1ms	Number of packets received on the stream with jitter up to 1 millisecond.

RTP Packets With Jitter Up To 3ms	Number of packets received on the stream with jitter up to 3 milliseconds.
RTP Packets With Jitter Up To 5ms	Number of packets received on the stream with jitter up to 5 milliseconds.
RTP Packets With Jitter Up To 10ms	Number of packets received on the stream with jitter up to 10 milliseconds.
RTP Packets With Jitter Up To 20ms	Number of packets received on the stream with jitter up to 20 milliseconds.
RTP Packets With Jitter Up To 40ms	Number of packets received on the stream with jitter up to 40 milliseconds.
RTP Packets With Jitter More Than 40ms	Number of packets received on the stream with jitter over 40 milliseconds.
RTP Average Jitter (ns)	Average jitter, in nanoseconds.
RTP Min Jitter (ns)	Lowest jitter recorded, in nanoseconds.
RTP Max Jitter (ns)	Largest jitter recorded, in nanoseconds.
RTP DTMFs Detected	Total number of path confirmation DTMF tone sequences sent.
RTP Good DTMF Sequences Detected	Total number of correct path confirmation DTMF tone sequences received.
RTP DTMFs Matched	Number of DTMF sequences received that matched the sequence specified on the Detect DTMF command. This statistic is not related to the option to perform path confirmation using DTMF digits.
RTP DTMFs Not Matched	Number of DTMF sequences received that did not match the sequence specified on the Detect DTMF command. This statistic is not related to the option to perform path confirmation using DTMF digits.
RTP Good DTMF Sequences Detected	Total number of correct path confirmation DTMF tone sequences received.
RTP Bad DTMF Sequences Detected	Total number of incorrect path confirmation DTMF tone sequences received.
RTP DTMF Detection Timeout	Number of DTMF detection attempts (by the Detect DTMF command) that ended because one of the timeout timers expired.



RTP DTMF Digits Sent	Number of DTMF digits sent by Generate DTMF commands. This statistic is not related to the option to perform path confirmation using DTMF digits.
RTP DTMF Sequences Sent	Number of DTMF sequences sent by Generate DTMF commands. This statistic is not related to the option to perform path confirmation using DTMF digits.
RTP MF Digits Sent	Number of MF digits sent by Generate MF commands.
RTP MF Sequences Sent	Number of MF sequences sent by Generate MF commands.
RTP Custom Tones Sent	Number of custom tones sent by Generate Tone commands.
RTP Packets Dropped By Jitter Buffer	Total number of packets dropped from the jitter buffer because they were received late.
<b>Video Statistics</b>	
Video Total Bytes Sent	Total video bytes sent by the server.
Video Total Packets Sent	Total video packets sent by the server.
Video Tx Jitter (ns)	Variation in video packet transmission times, in nanoseconds.
Video Tx Packets Dropped	Number of video packets dropped before transmission.
<b>Video Global Stream Statistics</b>	
Video Frame Stats Disabled	<p>Initially, this statistic displays no value.</p> <p>If the received data rate exceeds the cut-off threshold, IxLoad stops computing the I-, P-, and B-frame statistics and this statistic will display "YES".</p> <p>The value will remain YES until the end of the iteration. Once frame statistics computation is disabled during a run, it remains disabled throughout the remainder of the run.</p> <p>Prior to starting the next run (or the next iteration of the same test), this statistic will be cleared and IxLoad will again begin computing the frame statistics. It will continue to compute the frame statistics as long as the bit rate remains below the cut-off threshold.</p> <p>Note for Tcl API users: For this statistic, use the Aggregation Type <i>kString</i>.</p>

Video Quality Metrics Disabled	<p>Initially, this statistic displays no value.</p> <p>If the received data rate exceeds the cut-off threshold, IxLoad stops computing the Quality Metrics, and this statistic will display "YES".</p> <p>The value will remain YES until the end of the iteration. Once the Quality Metrics computation is disabled during a run, it remains disabled throughout the remainder of the run.</p> <p>Prior to starting the next run (or the next iteration of the same test), this statistic will be cleared and IxLoad will again begin computing the Quality Metrics. It will continue to compute the metrics as long as the bit rate remains below the cut-off threshold.</p> <p>Note for Tcl API users: For this statistic, use the Aggregation Type <i>kString</i>.</p>
Video Total Bytes Rcvd	Total number of video bytes received by the client.
Video Total packets Rcvd	Total number of video packets received by the client.
Video Total Loss	Total number video packets lost.
Video Unexpected UDP Packets Received	Number of UDP video packets received packets during a time when no channels are active.
Video Overload Packets Dropped	Number of RTP video packets dropped because a port did not have enough computing power to process them.
Video Total RTP Packets Lost	Total number of RTP video packets lost while using RTP over UDP transport.
Video Total Out Of Order RTP Packets	Total number of RTP video packets received in the wrong order while using RTP over UDP transport.
Video Total Duplicate RTP Packets	Total number of duplicate video RTP packets received.
Video Global Jitter	<p>Average variation in arrival times of video packets on all streams.</p> <p>Note for Tcl API users: This is a weighted statistic. If you are using this statistic in a Tcl script, use the <i>kWeightedAverage</i> aggregation type.</p>
Video Jitter less than 50 us	Number of video packets received with 0 to 50 microseconds of jitter.
Video Jitter between 50 - 100 us	Number of video packets received with 50 to 100 microseconds of jitter.
Video Jitter between 100 - 500 us	Number of video packets received with 100 -500 microseconds of jitter.

Video Jitter between 500 us - 2 ms	Number of video packets received with 500 microseconds to 2 milliseconds of jitter.
Video Jitter between 2 - 5 ms	Number of video packets received with 2 to 5 milliseconds of jitter.
Video Jitter between 5 - 10 ms	Number of video packets received with 5 to 10 milliseconds of jitter.
Video Jitter greater than 10 ms	Number of video packets received with more than 10 milliseconds of jitter.
Video Inter Packet Arrival Time between 0 - 2 ms	Number of video packets that arrived less than 2 milliseconds after the preceding packet was received.
Video Inter Packet Arrival Time between 2 - 5 ms	Number of video packets that arrived between 2 and 5 milliseconds after the preceding packet was received.
Video Inter Packet Arrival Time between 5 - 10 ms	Number of video packets that arrived between 5 and 10 milliseconds after the preceding packet was received.
Video Inter Packet Arrival Time between 10 - 25 ms	Number of video packets that arrived between 10 and 25 milliseconds after the preceding packet was received.
Video Inter Packet Arrival Time between 25 - 50 ms	Number of video packets that arrived between 25 and 50 milliseconds after the preceding packet was received.
Video Inter Packet Arrival Time between 50 - 100 ms	Number of video packets that arrived between 50 and 100 milliseconds after the preceding packet was received.
Video Inter Packet Arrival Time between 100 - 200 ms	Number of video packets that arrived between 100 and 200 milliseconds after the preceding packet was received.
Video Inter Packet Arrival Time between 200 - 500 ms	Number of video packets that arrived between 200 and 500 milliseconds after the preceding packet was received.
Video Inter Packet Arrival Time greater than 500 ms	Number of video packets that arrived more than 500 milliseconds after the preceding packet was received.

<b>Video Per-Stream Statistics</b>	
Video Active	Indicates whether the video stream is active or not: 0 = inactive 1 = active Note for Tcl API users: For this statistic, use the Aggregation Type <i>kString</i> .
Video Stream Name	Name of video stream. Note for Tcl API users: For this statistic, use the Aggregation Type <i>kString</i> .
Video Flow ID	Number identifying the flow used by the video stream. A flow consists of the packets flowing between a source IP:port and a destination IP:port. Note for Tcl API users: For this statistic, use the Aggregation Type <i>kString</i> .
Video Transport	Type of transport used on the video stream. Note for Tcl API users: For this statistic, use the Aggregation Type <i>kString</i> .
Video Codec	Video codec used on the video stream. Note for Tcl API users: For this statistic, use the Aggregation Type <i>kString</i> .
Video Stream Bit Rate	Bit rate used on video stream.
Video MDI-DF	Media Delay Index Delay Factor (MDI-DF) experienced on video stream.
Video MIN MDI-DF	Smallest MDI Delay Factor experienced on video stream.
Video MAX MDI-DF	Largest MDI Delay Factor experienced on video stream.
Video AVG-MDI-DF	Average MDI Delay Factor experienced on video stream.
Video MDI-MLR	Media Delay Index Media Loss Rate experienced on video stream.
Video Bytes	Number of bytes received on the video stream.
Video I Frames Rcvd	Number of I-frames received on the video stream. An I-frame is encoded with no reference to any previous or subsequent frames.

Video P Frames Rcvd	Number of P-frames received on the video stream. A P-frame is encoded relative to the previous reference frame.
Video B Frames Rcvd	Number of B-frames received on the video stream. A B-frame is encoded relative to the previous reference frame, the subsequent reference frame, or both.
Video Packets	Number of packets received on the video stream.
Video Loss	Number of packets lost on the video stream.
Video Jitter	Number of packets with jitter received on the video stream.
Video Inter Pkt Arrival Time	Amount of time between received video packets, in milliseconds.
Video Min Inter Pkt Arrival Time	Smallest amount of time between received video packets, in milliseconds.
Video Max Inter Pkt Arrival Time	Largest amount of time between received video packets, in milliseconds.
Video Packet Latency (ns)	Average packet latency on the video stream.
Video Min Packet Latency (ns)	Smallest packet latency on the video stream.
Video Max Packet Latency (ns)	Longest packet latency on the video stream.
Video Join Latency (ms)	Amount of time, in milliseconds, elapsed between the time the client sent an IGMP JOIN (broadcast channel) or RTSP PLAY (VoD channel) and the time it received the first byte of video data.
Video I Join Latency (ms)	Amount of time, in milliseconds, elapsed between the time the client sent an IGMP JOIN (broadcast channel) or RTSP PLAY (VoD channel) and the time it received the first I frame. This statistic is computed for MPEG2 transport streams carrying MPEG2 video data.
Video Leave Latency (ms)	Amount of time, in milliseconds, elapsed between the time the client sent an IGMP LEAVE (broadcast channel) or RTSP PAUSE (VoD channel) and the time it received the last byte of video data. Leave latency has a maximum timeout of 10 seconds; if the client continues to receive data 10 seconds after it has sent the Leave command, the latency is measured as 10 seconds.

Video Channel Switch Latency	Amount of time, in milliseconds, elapsed between the time the client sent an IGMP LEAVE (broadcast channel) or RTSP PAUSE (VoD channel) to stop receiving one video stream and the time it received the first byte of data of a new video stream.
Video Channel Gap Duration	Amount of time, in milliseconds, elapsed between the time the client sent an IGMP LEAVE (broadcast channel) and received the last byte of the old video stream and the time it received the first byte of data of a new video stream.
Video Channel Overlap Duration	Amount of time, in milliseconds, elapsed after sending an IGMP LEAVE (broadcast channel) that the client was simultaneously receiving both the old and new video streams.
Video Control Sent	Indicates the type of video control command that has most recently been sent: 0 = LEAVE or PAUSE/TEARDOWN sent 1 = JOIN or PLAY sent
Video Data Rcvd	Indicates whether or not video data is being received: 0 = no data received 1 = data received
Video RTP Packets Lost	Number of RTP video packets lost.
Video RTP Packets Out of Order	Number of RTP video packets received out of order.
Video RTP Packets Duplicated	Number of duplicate RTP video packets received.
<b>Video Quality Statistics</b>	
Video JB Packets Accepted	Number of video packets accepted into the jitter buffer.
Video JB Packets Early	Number of video packets that arrived earlier than expected in the jitter buffer.
Video JB Packets Discarded	Total number of video packets that were discarded. This statistic is the total of: JB Packets Discarded (Underrun) and JB Packets Discarded (Overrun).

Video JB Packets Discarded (Underrun)	Number of video packets discarded because they arrived after their expected time slot.
Video JB Packets Discarded (Overrun)	Number of video packets discarded because the jitter buffer was full.
Video MOS_V	Mean Opinion Score for Video. This score is computed from the Video Service Quality statistic to create a zero-to-five (0-5) assessment of the quality of the video stream.
Video Service Quality	A factor in the range from 0 to 120, which provides an assessment of the capability of the RTP channel to support video transmission.
Video Gap Video Service Quality	Video Service Quality during the Gap state. This statistic is cumulative, and is reset to zero (0) whenever you join or pause the channel/stream (Multicast/VOD mode) or change to the channel/stream (Broadcast mode).
Video Burst Video Service Quality	Video Service Quality during the Burst state. This statistic is cumulative, and is reset to zero (0) whenever you join or pause the channel/stream (Multicast/VOD mode) or change to the channel/stream (Broadcast mode).
Video Burst Count	Number of times the stream entered the Burst state. This statistic is cumulative, and is reset to zero (0) whenever you join or pause the channel/stream (Multicast/VOD mode) or change to the channel/stream (Broadcast mode).
Video Avg Gap Len (Pkts)	The average gap length, in packets. This statistic is cumulative, and is reset to zero (0) whenever you join or pause the channel/stream (Multicast/VOD mode) or change to the channel/stream (Broadcast mode).
Video Avg Burst Len (Pkts)	The average burst length, in packets. This statistic is cumulative, and is reset to zero (0) whenever you join or pause the channel/stream (Multicast/VOD mode) or change to the channel/stream (Broadcast mode).
Video Degradation (Loss)	The amount of the overall video quality degradation that can be attributed to packet loss. This statistic is cumulative, and is reset to zero (0) whenever you join or pause the channel/stream (Multicast/VOD mode) or change to the channel/stream (Broadcast mode).

Video Degradation (Discard)	<p>The amount of the overall video quality degradation that can be attributed to packets being discarded from the jitter buffer.</p> <p>This statistic is cumulative, and is reset to zero (0) whenever you join or pause the channel/stream (Multicast/VOD mode) or change to the channel/stream (Broadcast mode).</p>
Video Degradation (Video Codec)	<p>The amount of the overall quality degradation that can be attributed to video codec selection.</p> <p>This statistic is cumulative, and is reset to zero (0) whenever you join or pause the channel/stream (Multicast/VOD mode) or change to the channel/stream (Broadcast mode).</p>
Video Current JB Packets Accepted	Number of video packets accepted into the jitter butter during the current statistics Update Interval.
Video Current JB Packets Discarded	Number of video packets discarded from the jitter butter during the current statistics Update Interval.
Video Current JB Packets Lost	Number of video packets lost during the current statistics Update Interval.
Video Current Video Service Quality	Video Service Quality during the current statistics update interval.



# CIFS

This section describes the CIFS Tcl API objects.

## API Overview

The IxLoad CIFS API consists of the CIFS Client Agent, its commands, and a CIFS Server Agent.

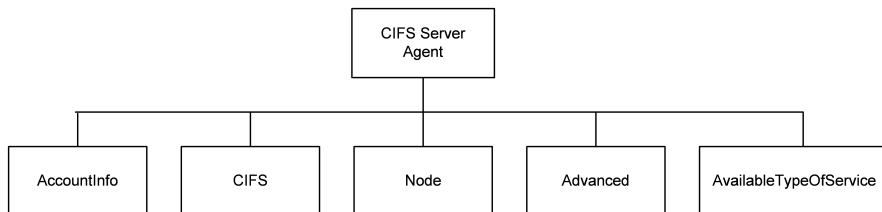

## Objectives

The objectives (userObjective) you can set for CIFS are listed below. Test objectives are set in the ixTimeline object.

- simulatedUsers
- connectionRate
- concurrentConnections
- throughputMbps
- throughputKbps
- throughputGbps
- transactionRate



---

## CIFS Client Agent

CIFS client agent - create a CIFS client agent

### SYNOPSIS

```
set Activity_CIFSClient1 [$Traffic1_Network1 activityList.appendItem \  
-protocolAndType          "cifs Client" ]
```

### DESCRIPTION

A CIFS client agent is added to the activityList object. The activityList object is added to the ixNetTraffic object using the appendItem subcommand from the ixConfigSequenceContainer command.

### SUBCOMMANDS

None.

### OPTIONS

The options for this command are configured and read using the standard config, cget, and getOptions subcommands defined in the ixConfig command.

### STATISTICS

### EXAMPLE

```
set Activity_CIFSClient1 [$Traffic1_Network1 activityList.appendItem \  
-protocolAndType          "cifs Client" ]
```

### SEE ALSO

[ixNetTraffic](#)

## **CIFS Client Commands**

This section lists the CIFS client agent's commands.

## CIFS Basic configuration

CIFS Basic config - configure the basic properties of a CIFS client agent

### SYNOPSIS

```
$Activity_CIFSClient1 agent.pm.basic.config
```

### DESCRIPTION

This object configures the basic properties of a CIFS client agent.

### SUBCOMMANDS

None.

### OPTIONS

```
enableUnicode
```

Enables Unicode support.

Default = 0

```
enableLock
```

Lock type.

Values	Description
0 (Default)	None
2	Exclusive
4	Batch
6	Both Batch and Exclusive

```
protocolVersion
```

CIFS protocol version. The only choice is NT LM 0.12.

Default = 1 (NT LM 0.12)

```
authentication
```

Authentication mechanism used.

Values	Description
1 (Default)	NTLM

2	NTLMv2
3	Plaintext

`primaryDomain`

Client's primary domain. Minimum length = 1, maximum length = 256.

Default = IXIACOM

`nativeOs`

String identifying the operating system. Minimum length = 1, maximum length = 255.

Default = "Windows 2002 Service Pack 2 2600"

`nativeLanMan`

String identifying the native LAN manager. Minimum length = 1, maximum length = 255

Default = "Windows 2002 5.1"

`commandTimeout`

Number of seconds to wait for a response to a command.

Min = 1, Max = 65535, Default = 10

`chunk_size`

The length of Data Chunk to write in each WriteAndX.

Min = 1, max = 15728640, Default = 65535

`chunk_size_unit`

Number of Data Chunks to write in each WriteAndX.

Min = 0, Max = 2, Default= 2

`enablerandomdummy`

If true, dummy data is randomized.

Default = 0

`block_size`

Block size of random data.

Default = 4096

`syntheticPatternGenOption`

If true, the synthetic pattern generator is used to generate data.

Default = 0

**EXAMPLE**

```
$Activity_CIFSClient1 agent.pm.basic.config \  
-nativeLanMan          "Windows 2002 5.1" \  
-commandTimeout       10 \  
-enableUnicode        false \  
-syntheticPatternGenOption 0 \  
-protocolVersion      1 \  
-authentication       2 \  
-chunk_size_unit      2 \  
-enableLock           0 \  
-enablerandomdummy    false \  
-chunk_size           65535 \  
-nativeOs             "Windows 2002 Service Pack 2 2600" \  
-block_size           4096 \  
-primaryDomain        "IXIACOM"
```

**SEE ALSO**

[ixNetTraffic](#)

## CIFS Advanced configuration

CIFS Advanced config - configure the advanced properties of a CIFS client agent

### SYNOPSIS

```
$Activity_CIFSClient1 agent.pm.advanced.config
```

### DESCRIPTION

This object configures the advanced properties of a CIFS client agent.

### SUBCOMMANDS

None.

### OPTIONS

`enableEsm`

Enables sending of MSS size.

Default = 0

`esm`

MSS size.

Min = 64, max = 1460, default = 1460

`enableTOS`

Enables setting of TOS bits.

Min = 64, max = 1460, default = 1460

`typeOfService`

TOS bit setting. Must be one of the choices configured in `availableTosList`.

Default = Best Effort (0x0)

### EXAMPLE

```
$Activity_CIFSClient1 agent.pm.advanced.config \  
-enableTOS                false \  
-esm                      1460 \  
-enableEsm                false \  
-typeOfService            "Best Effort (0x0)"
```



**SEE ALSO**

[ixNetTraffic](#)

## availableTosList

availableTosList - configure the list of ToS levels for a CIFS client.

### SYNOPSIS

```
$Activity_CIFSClient1 agent.pm.availableTosList.appendItem \  
-id "AvailableTypeOfService" \  
-tos_value "Best Effort (0x0)"
```

### DESCRIPTION

The `availableTosList` object configures the list of available ToS levels.

To add a ToS level to the list, you use the `appendItem` subcommand from the `ixConfigSequenceContainer` command. Other `ixConfigSequenceContainer` subcommands may be used to modify the `availableTosList`. It is customary to set all the options of the `availableTosList` during the `appendItem` call.

Each member of the list can be separately addressed and modified using the `ixConfig` subcommands.

Before you add items to the `availableTosList`, you should initialize the list by using the `clear` subcommand of the `ixConfigSequenceContainer` command.

### SUBCOMMANDS

#### OPTIONS

`id`

ToS list name. (Default = "AvailableTypeOfService").

`tos_value`

ToS level to be added to the list. Default = "" (null).

Choices:

"Best Effort (0x0)"

"Class 1 (0x20)"

"Class 2 (0x40)"

"Class 3 (0x60)"

"Class 4 (0x80)"

"Express Forwarding (0xA0)"

"Control (0xC0)"

## STATISTICS

### EXAMPLE

```
$Activity_CIFSClient1 agent.pm.availableTosList.appendItem \  
-id                "AvailableTypeOfService" \  
-tos_value         "Best Effort (0x0)"
```

### SEE ALSO

## CIFS Server Agent

CIFS server agent - create a CIFS server agent

### SYNOPSIS

```
set Activity_CIFSServer1 [$Traffic2_Network2 activityList.appendItem \  
-protocolAndType          "cifs Server" ]
```

### DESCRIPTION

A CIFS server agent is added to the activityList object. The activityList object is added to the ixNetTraffic object using the appendItem subcommand from the ixConfigSequenceContainer command.

### SUBCOMMANDS

None.

### OPTIONS

The options for this command are configured and read using the standard `config`, `cget`, and `getOption` subcommands defined in the `ixConfig` command.

### STATISTICS

### EXAMPLE

```
set Activity_CIFSServer1 [$Traffic2_Network2 activityList.appendItem \  
-protocolAndType          "cifs Server" ]
```

### SEE ALSO

[ixNetTraffic](#)

## CIFS configuration

CIFS config - configure the basic properties of a CIFS server agent

### SYNOPSIS

```
$Activity_CIFSClient1 agent.pm.basic.config
```

### DESCRIPTION

This object configures the basic properties of a CIFS client agent.

### SUBCOMMANDS

None.

### OPTIONS

```
authenticationLevel
```

Enable / disable authentication.

Value	Description
0 (default)	No authentication
1	User-level authentication

```
authenticationMechanism
```

Mode used for user-level authentication.

Value	Description
0	NTLM
1 (default)	NTLM v2
2	Both NTLM and NTLM v2
3	PlainText

```
enableGuestLogin
```

Enables guest access to server.

Default = 0

```
enableByteByteDataCheck
```

Enables byte-for-byte data integrity check.

Default = 0

`enableRandomDummy`

Enables support for random dummy data.

Default = 0

`block_size`

The size of the random block.

Default = 4096

### EXAMPLE

```
$Activity_CIFSServer1 agent.pm.cifs.config \  
-enablePlaintext          false \  
-enableGuestLogin         false \  
-enableByteByteDataCheck false \  
-enableChallengeResponse  true \  
-enableRandomDummy       false \  
-block_size               4096 \  
-authenticationMechanism  1 \  
-authenticationLevel      0
```

### SEE ALSO

[ixNetTraffic](#)

## User Info

CIFS user info - object list for storing users, with their password and domain

### SYNOPSIS

```
$Activity_CIFSClient1 agent.pm.basic.config
```

### DESCRIPTION

This object creates a list of users together with their passwords and domains.

Items are added to the list using the `appendItem` subcommand from the `ixConfigSequenceContainer` command. The options are configured and read using the standard `config`, `cget`, and `getOptions` subcommands defined in the `ixConfig` command.

### SUBCOMMANDS

None.

### OPTIONS

`id`

Name of the user info list.

Default = AccountInfo

`username`

User name. Maximum length = 255.

Default = "User <number>"

`password`

Password for user name. Maximum length = 255.

Default = "password"

`domain`

User domain. Maximum length = 255.

Default = "IXIACOM"

### EXAMPLE

```
$Activity_CIFSServer1 agent.pm.cifs.UserInfo.clear
```

```
$Activity_CIFSServer1 agent.pm.cifs.UserInfo.appendItem \  
-id AccountInfo \  
-password password \  
-domain IXIACOM \  
-username User1
```

```
-username      "User0" \  
-domain       "IXIACOM" \  
-password     "password"
```

**SEE ALSO**

[ixNetTraffic](#)



---

## Advanced configuration

CIFS server advanced configuration - configure the advanced properties of a CIFS server

### SYNOPSIS

```
$Activity_CIFSServer1 agent.pm.advanced.config \
```

### DESCRIPTION

This object configures the advanced properties of a CIFS server.

### SUBCOMMANDS

None.

### OPTIONS

`enableEsm`

Enables sending of MSS size.

Default = 0

`esm`

MSS size.

Min = 64, max = 1460, default = 1460

`enableTOS`

Enable setting of TOS bits.

Default = 0

`typeOfService`

TOS bit setting. Must be one of the settings configured in the `availableTosList`. See `availableTosList` (see "[availableTosList](#)") for a description of creating an `availableTosList`.

Default = "Best Effort (0x0)"

`listening_port`

Comma separated list of listening ports. (for example 143, 243, 343, 443)

Default = 445

### EXAMPLE

```
$Activity_CIFSServer1 agent.pm.advanced.config \
```

```
-enableTOS                false \
```

-esm 1460 \  
-enableEsm false \  
-typeOfService "Best Effort (0x0)" \  
-listening\_port "445"

**SEE ALSO**

[ixNetTraffic](#)

---

## Shared Pool

CIFS server shared pool - configure the shared folders on the server

### SYNOPSIS

```
$Activity_CIFSServer1 agent.pm.advanced.config \
```

### DESCRIPTION

This object configures the shared files and folder structure on the CIFS server.

To add a file or folder to the list, you use the `appendItem` subcommand from the `ixConfigSequenceContainer` command. Other `ixConfigSequenceContainer` subcommands may be used to modify the list. It is customary to set all the options of the list during the `appendItem` call.

Each member of the list can be separately addressed and modified using the `ixConfig` subcommands.

Before you add items to the list, you should initialize the list by using the `clear` subcommand of the `ixConfigSequenceContainer` command.

### SUBCOMMANDS

None.

### OPTIONS

`selfId`

ID for this item.

Default = 1

`parentId`

ID of the parent folder of this item.

Default = 1

`dateCreated`

Date the file or folder was created. The value for this option is a double data type, where the decimal part stores the number of days passed since 1st Jan, 1970 to now, and the fractional part specifies the number of milliseconds passed since last midnight.

Default = ""(none)

`dateAccessed`

Date the file or folder was last accessed. The value for this option is a double data type, where the decimal part stores the number of days passed since 1st Jan, 1970 to now, and the fractional part specifies the number of milliseconds passed since last midnight.

Default = ""(none)

`dateModified`

Date the file or folder was last modified. The value for this option is a double data type, where the decimal part stores the number of days passed since 1st Jan, 1970 to now, and the fractional part specifies the number of milliseconds passed since last midnight.

Default = ""(none)

`payloadType`

Payload type.

Values	Description
0	Dummy
1	Real
2	Synthetic Pattern Generator

`realFilePath`

Path for real file if the payload is a real file.

Default = "" (none)

`dataLength`

The length of data to write.

Min = 0, max = 2147483647, default = 0

`nodeType`

Type of object added to the shared pool.

Values	Description
0 (default)	File
1	Folder
2	Root

**EXAMPLE**

```
$Activity_CIFSServer1 agent.pm.sharedPool.appendItem \
```

```
-id                "Node" \  
-name              "root1" \  
-enableRandomDataLength  false \  
-selfId            1 \  
-dateCreated       14768.40324 \  
-payloadType       0 \  
-maxDataLength     0 \  
-dataLength        0 \  
-parentId          -1 \  
-dateAccessed      14768.40324 \  
-dateModified      14768.40324 \  
-realFilePath      ""
```

```
$Activity_CIFSServer1 agent.pm.sharedPool.appendItem \
```

```
-id                "Node" \  
-name              "folder2" \  
-enableRandomDataLength  false \  
-selfId            2 \  
-dateCreated       14768.40324 \  
-payloadType       0 \  
-maxDataLength     0 \  
-dataLength        0 \  
-parentId          1 \  
-dateAccessed      14768.40324 \  
-dateModified      14768.40324 \  
-realFilePath      ""
```

```
$Activity_CIFSServer1 agent.pm.sharedPool.appendItem \
```

```
-id                "Node" \  
-name              "file3" \  
-enableRandomDataLength  false \  
-selfId           3 \  
-dateCreated       14768.40324 \  
-payloadType       0 \  
-maxDataLength     0 \  
-dataLength        0 \  
-parentId          1 \  
-dateAccessed     14768.40324 \  
-dateModified     14768.40324 \  
-realFilePath      ""
```

**SEE ALSO**

[ixNetTraffic](#)

## Statistics

This section describes the CIFS statistics.

## CIFS Client Statistics

The following table describes the CIFS client statistics.

Statistic	Description
CIFS Active Connections	Number of CIFS sessions currently active.
CIFS Total Connections Requested	Number of sessions that the CIFS client attempted to establish.
CIFS Total Connections Succeeded	Number of sessions successfully established.
CIFS Total Connections Failed	Number of sessions that could not be established.
CIFS Integrity Check Succeeded	Number of integrity checks in which the data was verified to be free of errors.
CIFS Integrity Check Failed	Number of integrity checks in which the data failed verification.
CIFS Average Session Duration	Average duration of a CIFS session. This statistic computes the length of a CIFS session beginning when the TCP connection is established and ending when the TCP session is closed.
<b>CIFS Data Integrity Statistics</b>	
CIFS Client Total Data Integrity Check Failed	Total number of data integrity (DI) comparisons in which the data the client received was different from what it expected.
CIFS Client Total Data Integrity Check Succeeded	Total number of data integrity (DI) comparisons in which the data the client received matched the data that it expected. <b>Note:</b> Zero-byte reads do not contain any data for comparison, so they are always considered successful. Therefore, every time the client performs a read of zero bytes, this statistic is incremented.
<b>CIFS Negotiation Statistics</b>	



CIFS Protocol Negotiation Average Latency	Average time elapsed between the time the client sent an SMB_COM_NEGOTIATE request containing the list of dialects it supports and the time it received the server's response.
CIFS Total Protocol Negotiation Attempted	Number of attempts the client made to negotiate an SMB protocol with the server.
CIFS Total Protocol Negotiation Succeeded	Number of protocol negotiations that succeeded.
CIFS Total Protocol Negotiation Failed (Error)	Number of protocol negotiations that failed due to an error.
CIFS Total Protocol Negotiation Failed (Timed Out)	Number of protocol negotiations that failed because the client did not receive a response from the server within the timeout period.
<b>CIFS Sessions Statistics</b>	
CIFS SessionSetupAndX Average Latency	Average time elapsed between the time the client sent an SMB_COM_SESSION_SETUP_ANDX request and the time it received the server's response.
CIFS Total SessionSetupAndX Sent	Number of SMB_COM_SESSION_SETUP_ANDX requests sent by the client.
CIFS Total SessionSetupAndX Succeeded	Number of SMB_COM_SESSION_SETUP_ANDX requests that succeeded.
CIFS Total SessionSetupAndX failed (Error)	Number of SMB_COM_SESSION_SETUP_ANDX requests that failed due to an error.
CIFS Total SessionSetupAndX failed (Timed Out)	Number of SMB_COM_SESSION_SETUP_ANDX requests that failed because the client did not receive a response within the timeout period.
CIFS Total SessionSetupAndX failed (badpw)	Number of SMB_COM_SESSION_SETUP_ANDX requests that failed because the password was incorrect.

CIFS Total SessionSetupAndX failed (toomanyuids)	Number of SMB_COM_SESSION_SETUP_ANDX requests that failed because the maximum number of users per session was exceeded.
CIFS Total SessionSetupAndX failed (nosupport)	Number of SMB_COM_SESSION_SETUP_ANDX requests that failed because the function is not supported.
CIFS Total Sessions close successfully	Total number of CIFS sessions that were closed normally.
<b>CIFS Command Statistics</b>	
<b>TREE_CONNECT_AndX Statistics</b>	
CIFS TreeConnectAndX Average Latency	Average time elapsed between the time the client sent an SMB_COM_TREE_CONNECT_ANDX request and the time it received the server's response.
CIFS Total TreeConnectAndX Sent	Number of SMB_COM_TREE_CONNECT_ANDX requests sent by the client.
CIFS Total TreeConnectAndX Succeeded	Number of SMB_COM_TREE_CONNECT_ANDX requests that succeeded.
CIFS Total TreeConnectAndX Failed (Error)	Number of SMB_COM_SESSION_SETUP_ANDX requests that failed due to an error.
CIFS Total TreeConnectAndX Failed (Timed Out)	Number of SMB_COM_SESSION_SETUP_ANDX requests that failed because the client did not receive a response within the timeout period.
<b>NT_CREATE_AndX Statistics</b>	
CIFS NT_CreateAndX Average Latency	Average time elapsed between the time the client sent an SMB_COM_NT_CREATE_ANDX request and the time it received the server's response.
CIFS Total NT_CreateAndX Sent	Number of SMB_COM_NT_CREATE_ANDX requests sent by the client.
CIFS Total NT_CreateAndX Succeeded	Number of SMB_COM_NT_CREATE_ANDX requests that succeeded.

CIFS Total NT_CreateAndX Failed (Error)	Number of SMB_COM_NT_CREATE_ANDX requests that failed due to an error.
CIFS Total NT_CreateAndX Failed (Timed Out)	Number of SMB_COM_NT_CREATE_ANDX requests that failed because the client did not receive a response within the timeout period.
<b>Trans Statistics</b>	
CIFS Trans Average Latency	Average time elapsed between the time the client sent an SMB_COM_TRANSACTION request and the time it received the server's response.
CIFS Total Trans Sent	Number of SMB_COM_TRANSACTION requests sent by the client.
CIFS Total Trans Succeeded	Number of SMB_COM_TRANSACTION requests that succeeded.
CIFS Total Trans Failed (Error)	Number of SMB_COM_TRANSACTION requests that failed due to an error.
CIFS Total Trans Failed (Timed Out)	Number of SMB_COM_TRANSACTION requests that failed because the client did not receive a response within the timeout period.
<b>READ_ANDX Statistics</b>	
CIFS ReadAndX Average Latency	Average time elapsed between the time the client sent an SMB_COM_READ_ANDX request and the time it received the server's response.
CIFS Total ReadAndX Sent	Number of SMB_COM_READ_ANDX requests sent by the client.
CIFS Total ReadAndX Succeeded	Number of SMB_COM_READ_ANDX requests that succeeded.
CIFS Total ReadAndX Failed (Error)	Number of SMB_COM_READ_ANDX requests that failed due to an error.
CIFS Total ReadAndX Failed (Timed Out)	Number of SMB_COM_READ_ANDX requests that failed because the client did not receive a response within the timeout period.
<b>WRITE_ANDX Statistics</b>	

CIFS WriteAndX Average Latency	Average time elapsed between the time the client sent an SMB_COM_WRITE_ANDX request and the time it received the server's response.
CIFS Total WriteAndX Sent	Number of SMB_COM_WRITE_ANDX requests sent by the client.
CIFS Total WriteAndX Succeeded	Number of SMB_COM_WRITE_ANDX requests that succeeded.
CIFS Total WriteAndX Failed (Error)	Number of SMB_COM_WRITE_ANDX requests that failed due to an error.
CIFS Total WriteAndX Failed (Timed Out)	Number of SMB_COM_WRITE_ANDX requests that failed because the client did not receive a response within the timeout period.
<b>COPY Statistics</b>	
CIFS COPY Average Latency	Average time elapsed between the time the client sent an SMB_COM_COPY request and the time it received the server's response.
CIFS Total COPY Sent	Number of SMB_COM_COPY requests sent by the client.
CIFS Total COPY Succeeded	Number of SMB_COM_COPY requests that succeeded.
CIFS Total COPY Failed (Error)	Number of SMB_COM_COPY requests that failed due to an error.
CIFS Total COPY Failed (Timed Out)	Number of SMB_COM_COPY requests that failed because the client did not receive a response within the timeout period.
<b>MOVE Statistics</b>	
CIFS MOVE Average Latency	Average time elapsed between the time the client sent an SMB_COM_MOVE request and the time it received the server's response.
CIFS Total MOVE Sent	Number of SMB_COM_MOVE requests sent by the client.
CIFS Total MOVE Succeeded	Number of SMB_COM_MOVE requests that succeeded.

CIFS Total MOVE Failed (Error)	Number of SMB_COM_MOVE requests that failed due to an error.
CIFS Total MOVE Failed (Timed Out)	Number of SMB_COM_MOVE requests that failed because the client did not receive a response within the timeout period.
<b>DELETE Statistics</b>	
CIFS DELETE Average Latency	Average time elapsed between the time the client sent an SMB_COM_DELETE request and the time it received the server's response.
CIFS Total DELETE Sent	Number of SMB_COM_DELETE requests sent by the client.
CIFS Total DELETE Succeeded	Number of SMB_COM_DELETE requests that succeeded.
CIFS Total DELETE Failed (Error)	Number of SMB_COM_DELETE requests that failed due to an error.
CIFS Total DELETE Failed (Timed Out)	Number of SMB_COM_DELETE requests that failed because the client did not receive a response within the timeout period.
<b>RENAME Statistics</b>	
CIFS RENAME Average Latency	Average time elapsed between the time the client sent an SMB_COM_RENAME request and the time it received the server's response.
CIFS Total RENAME Sent	Number of SMB_COM_RENAME requests sent by the client.
CIFS Total RENAME Succeeded	Number of SMB_COM_RENAME requests that succeeded.
CIFS Total RENAME Failed (Error)	Number of SMB_COM_RENAME requests that failed due to an error.
CIFS Total RENAME Failed (Timed Out)	Number of SMB_COM_RENAME requests that failed because the client did not receive a response within the timeout period.
<b>CLOSE Statistics</b>	
CIFS CLOSE Average Latency	Average time elapsed between the time the client sent an SMB_COM_CLOSE request and the time it received the server's response.
CIFS Total CLOSE Sent	Number of SMB_COM_CLOSE requests sent by the client.

CIFS Total CLOSE Succeeded	Number of SMB_COM_CLOSE requests that succeeded.
CIFS Total CLOSE Failed (Error)	Number of SMB_COM_CLOSE requests that failed due to an error.
CIFS Total CLOSE Failed (Timed Out)	Number of SMB_COM_CLOSE requests that failed because the client did not receive a response within the timeout period.
<b>LOGOFF_ANDX Statistics</b>	
CIFS LogoffAndX Average Latency	Average time elapsed between the time the client sent an SMB_COM_LOGOFF_ANDX request and the time it received the server's response.
CIFS Total LogoffAndX Sent	Number of SMB_COM_LOGOFF_ANDX requests sent by the client.
CIFS Total LogoffAndX Succeeded	Number of SMB_COM_LOGOFF_ANDX requests that succeeded.
CIFS Total LogoffAndX Failed (Error)	Number of SMB_COM_LOGOFF_ANDX requests that failed due to an error.
CIFS Total LogoffAndX Failed (Timed Out)	Number of SMB_COM_LOGOFF_ANDX requests that failed because the client did not receive a response within the timeout period.
<b>TRANS2_FIND_FIRST2 Statistics</b>	
CIFS Trans2FindFirst2 Average Latency	Average time elapsed between the time the client sent an SMB_COM_TRANSACTION2 request with an TRANS2_FIND_FIRST2 subcommand and the time it received the server's response.
CIFS Total Trans2FindFirst2 Sent	Number of TRANS2_FIND_FIRST2 subcommands sent by the client.
CIFS Total Trans2FindFirst2 Succeeded	Number of TRANS2_FIND_FIRST2 subcommands that succeeded.
CIFS Total Trans2FindFirst2 Failed (Error)	Number of TRANS2_FIND_FIRST2 subcommands that failed due to an error.

CIFS Total Trans2FindFirst2 Failed (Timed Out)	Number of TRANS2_FIND_FIRST2 subcommands that failed because the client did not receive a response within the timeout period.
<b>TRANS2_SET_FILE_INFORMATION Statistics</b>	
CIFS Trans2SetFileInfo Average Latency	Average time elapsed between the time the client sent an SMB_COM_TRANSACTION2 request with an TRANS2_SET_FILE_INFORMATION subcommand and the time it received the server's response.
CIFS Total Trans2SetFileInfo Sent	Number of TRANS2_SET_FILE_INFORMATION subcommands sent by the client.
CIFS Total Trans2SetFileInfo Succeeded	Number of TRANS2_SET_FILE_INFORMATION subcommands that succeeded.
CIFS Total Trans2SetFileInfo Failed (Error)	Number of TRANS2_SET_FILE_INFORMATION subcommands that failed due to an error.
CIFS Total Trans2SetFileInfo Failed (Timed Out)	Number of TRANS2_SET_FILE_INFORMATION subcommands that failed because the client did not receive a response within the timeout period.
<b>TREE_DISCONNECT Statistics</b>	
CIFS TreeDis- connect Average Latency	Average time elapsed between the time the client sent an SMB_COM_TREE_DISCONNECT request and the time it received the server's response.
CIFS Total TreeDis- connect Sent	Number of SMB_COM_TREE_DISCONNECT requests sent by the client.
CIFS Total TreeDis- connect Succeeded	Number of SMB_COM_TREE_DISCONNECT requests that succeeded.
CIFS Total TreeDis- connect Failed (Error)	Number of SMB_COM_TREE_DISCONNECT requests that failed due to an error.
CIFS Total TreeDis- connect Failed (Timed Out)	Number of SMB_COM_TREE_DISCONNECT requests that failed because the client did not receive a response within the timeout period.

CIFS Dfs Path Not Covered Received	Number of error messages received from the server indicating that the requested file is stored on a different system (STATUS_DFS_PATH_NOT_COVERED messages).
<b>Requests Sent and Responses Received Statistics</b>	
CIFS Total Requests Sent	Total number of SMB requests sent by the client.
CIFS Total Responses Received	Total number of SMB responses received from the server.
<b>Bytes Statistics</b>	
CIFS Total Bytes Transmitted	Total number of bytes transmitted in CIFS packets.
CIFS Total Bytes Received	Total number of bytes received in CIFS packets.
CIFS Total Bytes Sent And Received	Combined total of bytes sent and received in CIFS packets.
CIFS Total Throughput	Rate at which the client sent and received CIFS packets.
<b>Transaction Statistics</b>	
CIFS Total Transactions	Total number of SMB transactions completed. For CIFS, a transaction consists of an SMB request and the server's response to it.
CIFS Total Commands Sent	Total number of SMB commands sent by the client.
CIFS Total Commands Succeeded	Total number of SMB commands that succeeded.
CIFS Total Commands Failed	Total number of SMB commands that failed for any reason.
CIFS Total Commands Failed (Timed Out)	Number of SMB commands that failed because the client did not receive a response from the server within the timeout period.



---

CIFS Total Com- mands Failed (Other)	Number of SMB commands that failed for reasons other than a timeout.
<b>Test Objective Statistics</b>	
CIFS Simulated Users	Number of CIFS clients simulated during the test.

## CIFS Server Statistics

The following table describes the CIFS server statistics.

Statistic	Description
<b>Session Statistics</b>	
CIFS Session Setup Succeeded	Number of CIFS sessions successfully setup.
CIFS Session Setup Failed	Number of CIFS sessions that could not be setup.
CIFS Session Close Succeeded	Number of CIFS sessions that ended normally.
<b>Bytes Statistics</b>	
CIFS Server Total Bytes Sent	Total number of bytes sent in CIFS packets by the server, including header and payload bytes.
CIFS Server Total Bytes Received	Total number of bytes received in CIFS packets by the server, including header and payload bytes.
CIFS Server Total Bytes Sent And Received	Combined total of bytes sent and received by the server in CIFS packets.
CIFS Active Connections	Number of CIFS connections established and in progress.
<b>Command Related Statistics</b>	
Negotiate Protocol Request Received	Number of NEGOTIATE messages received by the server.
Trans2 Set File Info Request Received	Number of SMB_COM_TRANSACTION2 requests received with the TRANS2_SET_FILE_INFORMATION subcommand code set.
Trans2 Find First2 Request Received	Number of SMB_COM_TRANSACTION2 requests received with the TRANS2_FIND_FIRST2 subcommand code set.
Trans2 Find Next2 Request Received	Number of SMB_COM_TRANSACTION2 requests received with the TRANS2_FIND_NEXT2 subcommand code set.
CIFS SessionSetupAndx Request Received	Number of SMB_COM_SESSION_SETUP_ANDX messages received by the server.
CIFS TreeConnectAndx Request Received	Number of SMB_COM_TREE_CONNECT_ANDX messages received by the server.

CIFS TreeDisconnect Request Received	Number of SMB_COM_TREE_DISCONNECT messages received by the server.
CIFS NT_CreateAndx Request Received	Number of SMB_COM_NT_CREATE_ANDX messages received by the server.
CIFS NetshareEnumall Request Received	Number of SMB_COM_NETSHARE_ENUM_ALL messages received by the server.
CIFS ReadAndx Request Received	Number of SMB_COM_READ_ANDX messages received by the server.
CIFS Rename Request Received	Number of SMB_COM_RENAME messages received by the server.
CIFS Delete Request Received	Number of SMB_COM_DELETE messages received by the server.
CIFS WriteAndx Request Received	Number of SMB_COM_WRITE_ANDX messages received by the server.
CIFS Close Request Received	Number of SMB_COM_CLOSE messages received by the server.
CIFS Logoff Request Received	Number of SMB_COM_LOGOFF_ANDX messages received by the server.
<b>Command Response Statistics</b>	
Negotiate Protocol Response Sent	Number of responses sent for SMB_COM_NEGOTIATE commands.
Trans2 Set File Info Response Sent	Number of responses sent for SMB_COM_TRANSACTION2 requests received with the TRANS2_SET_FILE_INFORMATION subcommand code set.
Trans2 Find First2 Response Sent	Number of responses sent for SMB_COM_TRANSACTION2 requests received with the TRANS2_FIND_FIRST2 subcommand code set.
Trans2 Find Next2 Response Sent	Number of responses sent for SMB_COM_TRANSACTION2 requests received with the TRANS2_FIND_NEXT2 subcommand code set.
CIFS SessionSetupAndx Response Sent	Number of responses sent for SMB_COM_SESSION_SETUP_ANDX commands.
CIFS TreeConnectAndx Response Sent	Number of responses sent for SMB_COM_TREE_CONNECT_ANDX commands.

CIFS TreeDisconnect Response Sent	Number of responses sent for SMB_COM_TREE_DISCONNECT commands.
CIFS NT_CreateAndx Response Sent	Number of responses sent for SMB_COM_NT_CREATE_ANDX commands.
CIFS Netsharenumall Response Sent	Number of responses sent for SMB_COM_NETSHARE_ENUM_ALL commands.
CIFS ReadAndx Response Sent	Number of responses sent for SMB_COM_READ_ANDX commands.
CIFS Rename Succeeded	Number of responses sent for SMB_COM_RENAME commands.
CIFS Delete Succeeded	Number of responses sent for SMB_COM_DELETE commands.
CIFS WriteAndx Response Sent	Number of responses sent for SMB_COM_WRITE_ANDX commands.
CIFS Close Response Sent	Number of responses sent for SMB_COM_CLOSE commands.
CIFS Logoff Response Sent	Number of responses sent for SMB_COM_LOGOFF_ANDX commands.
<b>Command Failed Statistics</b>	
The following statistics are updated when an error occurs or when an error response is generated for a invalid request.	
Negotiate Protocol Sent Failed	Number of SMB_COM_NEGOTIATE responses sent that did not result in a CIFS session being established.
Trans2 Set File Info Sent Failed	Number of responses sent for TRANS2_SET_FILE_INFORMATION commands that failed.
Trans2 Find First2 Sent Failed	Number of responses sent for TRANS2_FIND_FIRST2 commands that failed.
Trans2 Find Next2 Sent Failed	Number of responses sent for TRANS2_FIND_NEXT2 commands that failed.
CIFS SessionSetupAndx Sent Failed	Number of responses sent for SMB_COM_SESSION_SETUP_ANDX commands that failed.
CIFS TreeConnectAndx Sent Failed	Number of responses sent for SMB_COM_TREE_CONNECT_ANDX commands that failed.
CIFS TreeDisconnect Sent Failed	Number of responses sent for SMB_COM_TREE_DISCONNECT commands that failed.

CIFS NT_CreateAndx Sent Failed	Number of responses sent for SMB_COM_NT_CREATE_ANDX commands that failed.
CIFS Netsharenumall Sent Failed	Number of responses sent for SMB_COM_NETSHARE_ENUM_ALL commands that failed.
CIFS ReadAndx Sent Failed	Number of responses sent for SMB_COM_READ_ANDX commands that failed.
CIFS Rename Failed	Number of responses sent for SMB_COM_RENAME commands that failed.
CIFS Delete Failed	Number of responses sent for SMB_COM_DELETE commands that failed.
CIFS WriteAndx Sent Failed	Number of responses sent for SMB_COM_WRITE_ANDX commands that failed.
CIFS Close Sent Failed	Number of responses sent for SMB_COM_CLOSE commands that failed.
CIFS Logoff Sent Failed	Number of responses sent for SMB_COM_LOGOFF_ANDX commands that failed.
<b>SMB Error Statistics</b>	
CIFS Server Logon Failure	Number of failed attempts by clients to log on to the server.
CIFS Server Bad Password	Number of incorrect passwords provided by clients attempting to log on.
CIFS Server Bad User ID	Number of incorrect user names provided by clients attempting to log on.
CIFS Server Bad Filename	Number of attempts by clients to access files that do not exist on the server.
CIFS Server Bad Path	Number of attempts by clients to access paths that do not exist on the server.
CIFS Server Bad Access	Number of instances in which the client did not have the access rights to perform a function.
CIFS Server Bad Command	Number of SMB commands that the server did not recognize.
CIFS Server Invalid Parameter	Number of invalid parameters received in SMB commands.

! 13

# DHCP

This section describes the DHCP Tcl API objects.

## Overview

The IxLoad DHCP API consists of a client agent and its commands.

## Objectives

The objectives (userObjective) you can set for DHCP are listed below. Test objectives are set in the ixTimeline object.

- transactionRate
- simulatedUsers

## DHCP Client Agent

DHCP Client Agent

### SYNOPSIS

```
set Traffic1_Network1 [::IxLoad new ixNetTraffic]
set Activity_DHCPClient1 [$Traffic1_Network1 activityList.appendItem options...]
$Activity_DHCPClient1 agent.config
```

### DESCRIPTION

A DHCP client agent is added to the `activityList` object. The `activityList` object is added to the `ixNetTraffic` object using the `appendItem` subcommand from the `ixConfigSequenceContainer` command.

### SUBCOMMANDS

The options for this command are configured and read using the standard `config`, `cget`, and `getOption` subcommands defined in the `ixConfig` command.

### OPTIONS

`enable`

Enables the use of this client agent. (Default = true).

`name`

The name associated with this object, which must be set at object creation time.

`loopValue`

If this option is enabled (1), then the client progresses through the command list repeatedly until the test's sustain time. If the option is disabled (0), then the client will progress through the command list only once, and then go idle. (Default = 0).

### STATISTICS

### EXAMPLE

```
set Traffic1_Network1 [::IxLoad new
ixNetTraffic]##### Activity DHCPClient1
of NetTraffic Traffic1@Network1#####set
Activity_DHCPClient1 [$Traffic1_Network1 activityList.appendItem \-protocolAndType
"dhcp Client" ]$Activity_DHCPClient1 agent.config \-enable
true \-name "DHCPClient1"
```



**SEE ALSO**

[ixNetTraffic](#)

## DHCP Command List

DHCP Command List—Creates the list of DHCP commands that the client will send to a DHCP server.

### SYNOPSIS

```
set Traffic1_Network1 [::IxLoad new ixNetTraffic]
set Activity_DHCPClient1 [$Traffic1_Network1 activityList.appendItem options...]
$Activity_DHCPClient1 agent.pm.DHCPCommandList.appendItem
```

### DESCRIPTION

A command is added to the DHCP Command List object using the `appendItem` subcommand from the `ixConfigSequenceContainer` command.

### SUBCOMMANDS

The options for this command are configured and read using the standard `config`, `cget`, and `getOption` subcommands defined in the `ixConfig` command.

### OPTIONS

`id`

DHCP command to be executed. One of the following:

Command	Description
DHCPDiscover	Broadcasts a DHCPDISCOVER message—a broadcast to locate available servers. The client will then wait to receive one or more DHCPOFFER messages and select one of these offers.
DHCPRequest	<ul style="list-style-type: none"> <li>• Sends a DHCPREQUEST message. The DHCPREQUEST message can be used to perform several tasks:</li> <li>• It can request the offered parameters from one server and implicitly decline offers from all others.</li> <li>• It can confirm the correctness of a previously allocated address (for example, after a reboot).</li> <li>• It can extend the lease on a particular network address.</li> </ul>
DHCPDecline	Sends a DHCPDECLINE message. A DHCP client sends a DHCPDECLINE when it knows that an offered IP address is already in use.
DHCPRelease	Sends a DHCPRELEASE message. If a client no longer requires use of its assigned network address (for example, because it is shutting down), it sends a DHCPRELEASE message to the server.

DHCPInform	Sends a DHCPINFORM message. After sending the comthe client waits for a DHCPACK message from the server. The DHCPINFORM message allows hosts that are not using DHCP to acquire IP addresses to still utilize its other configuration capabilities to request that a server send it parameters for how the network is to be used.
Bind	An IxLoad command that is a composite of several DHCP commands that simulates a binding. The {Bind} command functions as follows: <ol style="list-style-type: none"> <li>1. Send a DHCPDISCOVER message.</li> <li>2. Wait to receive one or more DHCPOFFER messages from the servers.</li> <li>3. Send a DHCPREQUEST message to one of the servers.</li> <li>4. Wait to receive a DHCPACK message.</li> <li>5. Validate the IP address received. If it is invalid, then send a DHCPDECLINE message to the server.</li> </ol> Using the {Bind} command is equivalent to issuing a DHCPcommand followed by a DHCPREQUEST (SELECTING) command and an optional DHCPDECLINE command.
BindRelease	An IxLoad command that is a composite of several DHCP commands that simulates a client binding, pausing execution, and then releasing its IP address. It is included to help speed your testing. Using the {BindRelease} command is equivalent to using {Bind}, {Think}, and DHCPRELEASE.
BindRenew	An IxLoad command that is a composite of several DHCP commands that simulates a client binding, pausing execution, and then renewing its IP address. It is included to help speed your testing. Using the {BindRenew} command is equivalent to using {Bind}, {Think}, and DHCPREQUEST (RENEWING).
BOOTRequest	A BOOTP (Bootstrap Protocol) command that sends a BOOTREQUEST message and waits to receive a BOOTREmessage from a server.
Think	Causes the client to become idle. {Think} is an internal IxLoad command intended to assist your testing; it is not a command defined in the DHCP protocol. If you specify identical values for the minimum and maximum times, the client will be idle for a fixed length of time. If you specify different values for the minimum and maximum times, IxLoad will select a value within the range and cause the client to be idle for that length of time.

LoopBeginCommand	An IxLoad command that you can add to the Command List to cause the commands between it and the {LoopEndCommand} to be executed a specified number of times.
LoopEndCommand	Ends the list of commands that will be executed by the preceding Loop Begin} command.

### Arguments for id = DHCPDiscover

optionSet

Name of option set. A value for this argument must one of the name objects from the optionSet object. Minimum length = 1. (Default = "Default Option Set for DHCPDISCOVER").

serverAlgo

Determines how the client selects the DHCP server from among those offered. Minimum = 1, maximum = 3. The choices are:

Value	Description
1	(default) The client selects the server that replies first.
2	The client selects the server whose IP address is specified for the serverIPAddr argument.
3	The client selects a server at random from a pool of those that reply. Specify the number of servers in the upperLimit field.

serverIPAddr

If serverAlgo is set to 2, this is the IP address of the DHCP server. Minimum length = 7, maximum length = 19. (Default = "10.0.1.1").

upperLimit

If serverAlgo is set to 3, this is the number of servers in the pool. Minimum = 1, maximum length = 2147483647. (Default = "5").

### Arguments for id = DHCPRequest

sendState

State in which the client is to send the DHCPREQUEST message. See the state transition diagram in RFC 2131. Minimum = "1," maximum = "4." The choices are:

Value	Description
"1"	(default) Selecting
"2"	InitReboot
"3"	Renewing
"4"	Rebinding

### Arguments for id = DHCPDecline

optionSet

Name of option set. A value for this argument must one of the `name` objects from the `optionSet` object. Minimum length = 1. (Default = "Default Option Set for DHCPDECLINE").

### Arguments for id = DHCPRelease

optionSet

Name of option set. A value for this argument must one of the `name` objects from the `optionSet` object. Minimum length = 1. (Default = "Default Option Set for DHCPRELEASE").

### Arguments for id = DHCPInform

optionSet

Name of option set. A value for this argument must one of the `name` objects from the `optionSet` object. Minimum length = 1. (Default = "Default Option Set for DHCPINFORM").

clientIPAddr

IP address and subnet of client. The client will insert this address and subnet into the `CIAddr` field of the `DHCPINFORM` message. If the IP address has already been assigned, then this address will be ignored. Minimum length = "7," maxilength = "24." (Default = "10.0.0.1/8").

### Arguments for id = Bind

optionSet

Name of option set. A value for this argument must be one of the `name` objects from the `optionSet` object. Minimum length = 1. (Default = "Default Option Set for {Bind}").

serverAlgo

Determines how the client selects the DHCP server from among those offered. Minimum = 1, maximum = 3. The choices are:

Value	Description
1	(default) The client selects the server that replies first.
2	The client selects the server whose IP address is specified for the <code>serverIPAddr</code> argument.
3	The client selects a server at random from a pool of those that reply. Specify the number of servers in the <code>upperLimit</code> field.

`serverIPAddr`

If `serverAlgo` is set to 2, this is the IP address of the DHCP server. Minimum length = 7, maximum length = 19. (Default = "10.0.1.1/8").

`upperLimit`

If `serverAlgo` is set to 3, this is the number of servers in the pool. Minimum = 1, maximum length = 2,147,483,647. (Default = "5").

### Arguments for `id = BindRelease`

`timeToThinkMin`

Minimum length of time before the client releases the IP address. Minimum = "1," maximum = "2,147,483,647." (Default = "1").

`timeToThinkMax`

Maximum length of time before the client releases the IP address. Minimum = "1," maximum = "2,147,483,647." (Default = "1").

`optionSet`

Name of option set. A value for this argument must one of the `name` objects from the `optionSet` object. Minimum length = 1. (Default = "Default Option Set for {BindRelease}").

`serverAlgo`

Determines how the client selects the DHCP server from among those offered. Minimum = 1, maximum = 3. The choices are:

Value	Description
1	(default) The client selects the server that replies first.

2	The client selects the server whose IP address is specified for the <code>serverIPAddr</code> argument.
3	The client selects a server at random from a pool of those that reply. Specify the number of servers in the <code>upperLimit</code> field.

`serverIPAddr`

If `serverAlgo` is set to 2, this is the IP address of the DHCP server. Minimum length = 7, maximum length = 19. (Default = "10.0.1.1/8").

`upperLimit`

If `serverAlgo` is set to 3, this is the number of servers in the pool. Minimum = 1, maximum length = 2,147,483,647. (Default = "5").

### Arguments for `id = BindRenew`

`timeToThinkMin`

Minimum length of time before the client releases the IP address. If you set a value for `timeToThinkMin`, you must also set `timeToThinkMax` to the same value. Minimum = "1," maximum = "2,147,483,647." (Default = "1").

`timeToThinkMax`

Maximum length of time before the client releases the IP address. If you set a value for `timeToThinkMax`, you must also set `timeToThinkMin` to the same value. Minimum = "1," maximum = "2,147,483,647." (Default = "1").

`optionSet`

Name of option set. A value for this argument must one of the `name` objects from the `optionSet` object. Minimum length = 1. (Default = "Default Option Set for {BindRenew}").

`serverAlgo`

Determines how the client selects the DHCP server from among those offered. Minimum = 1, maximum = 3. The choices are:

Value	Description
1	(default) The client selects the server that replies first.
2	The client selects the server whose IP address is specified for the <code>serverIPAddr</code> argument.
3	The client selects a server at random from a pool of those that reply. Specify the number of servers in the <code>upperLimit</code> field.

serverIPAddr

If `serverAlgo` is set to 2, this is the IP address of the DHCP server. Minimum length = 7, maximum length = 19. (Default = "10.0.1.1/8").

upperLimit

If `serverAlgo` is set to 3, this is the number of servers in the pool. Minimum = 1, maximum length = 2,147,483,647. (Default = "5").

### Arguments for id = BOOTRequest

clientIPAddr

IP address and subnet of client. Minimum length = "7," maximum length = "24." (Default = "10.0.0.1/8").

serverName

Host name or IP address of the BOOTP server. In actual BOOTP implementations, this field (SName) is normally used by a client to specify a particular server that it wants to receive a a reply from.

If you enter a host name or IP address in this field, the client sends the BOOTREQUEST as a unicast message to the BOOTP server.

If you leave this field blank, the client sends the BOOTREQUEST as a broadcast message to the port number used by BOOTP to the broadcast address of the local network. Minimum length = "7," maximum length = "24." (Default = "10.0.0.1/8").

bootFileType

Indication to the BOOTP server as to the boot file that the client wants to receive. When the server receives the BOOTREQUEST, it determines which file contains the requested image, and uses Boot File Name field to send the name of the file to the client. Maximum length = 127. (Default="{ }").

optionSet

Name of option set. A value for this argument must be one of the `name` objects from the `optionSet` object. Minimum length = 1. (Default = "Default Option Set for {BOOTRequest}").

### Arguments for id = Think

timeToThinkMin

Minimum length of time that the client is idle. Minimum = "1," maximum = "2,147,483,647." (Default = "1").

timeToThinkMax

Maximum length of time that the client is idle. Minimum = "1," maximum = "2,147,483,647." (Default = "1").



---

## Arguments for id = LoopBeginCommand

loopCount

Number of times to repeat the enclosed commands. '0' treated as infinity. Mini= "0," maximum = "2,147,483,647." (Default = "5").

## Arguments for id = LoopEndCommand

None.

### EXAMPLE

```
$Activity_DHCPClient1 agent.pm.DHCPCommandList.appendItem \-id
"DHCPDiscover" \-upperLimit 5 \-optionSet
"Default Option Set for DHCPDISCOVER" \-serverAlgo 1 \-
serverIPAddr "10.0.1.1"
```

### SEE ALSO

[DHCP Client Agent](#)

## Advanced Options

Advanced Options—Sets the DHCP client agent’s global configuration options.

### SYNOPSIS

```
set Traffic1_Network1 [::IxLoad new ixNetTraffic]
set Activity_DHCPClient1 [$Traffic1_Network1 activityList.appendItem options...]
$Activity_DHCPClient1 agent.pm.advancedOptions.config
```

### DESCRIPTION

A DHCP client’s advanced configuration options are set by modifying the options of the `pm.advancedOptions` option of the DHCP Client Agent.

### SUBCOMMANDS

None.

### OPTIONS

`clientPort`

UDP port that the client listens on for DHCP and BOOTP responses. Minimum = 1, maximum = 65,535. (Default = 68).

`serverPort`

UDP port that the client addresses server requests to. Minimum = 1, maximum = 65535. (Default = 67).

`numRetransmit`

Number of times that the client will retransmit a request for which it has not received a response. Minimum = 0, maximum = 2,147,483. (Default = 3).

`initialTimeout`

Length of time that the client waits for a response to a request. If the Initial Timeout period expires, the client retransmits the request (unless `numRetransmit` is 0). Minimum = 1, maximum = 2,147,483. (Default = 4).

`timeoutIncrFactor`

If the client has retransmitted a timed-out request, this parameter increments the Initial Timeout value. Minimum = 1, maximum = 2,147,483. (Default = 2).

`maximumDHCPMsgSize`

Maximum size of a DHCP packet that the client will accept, including IP and UDP headers. According to RFC 2131, the minimum message size that a client should accept is 576 octets. Minimum = 576, maximum = 65,536. (Default = 576).

vendorClass

Text string identifying the vendor type and configuration of the DHCP client. Minimum length = 0, maximum length = 255. (Default = "IXIA IxLoad DHCP Client")

optionsOverload

If true, indicates to the server that the client will allow option overloading. (Default = 0).

broadcastBit

If true, sets the client's Broadcast bit to 1 in the 'flags' field in any DHCPDISCOVER or DHCPREQUEST messages that client sends. (Default = 0).

### EXAMPLE

```
$Activity_DHCPClient1 agent.pm.advancedOptions.config \-clientPort
68 \-firstLoad false \-maxDHCPMsgSize
576 \-broadcastBit false \-timeoutIncrFactor
2 \-numRetransmit 3 \-needValidation
false \-writeLeasesToFile false \-serverPort
67 \-optionsOverload false \-memRequiredForOptions
52 \-vendorClass "IXIA IxLoad DHCP Client" \-
initialTimeout 4 \-implicitLoopCheck
true
```

### SEE ALSO

[DHCP Client Agent](#)

## Relay Agent

Relay Agent—Enables the DHCP client agent to function as a DHCP relay agent and configuration the relay agent options.

### SYNOPSIS

```
set Traffic1_Network1 [::IxLoad new ixNetTraffic]
set Activity_DHCPClient1 [$Traffic1_Network1 activityList.appendItem options...]
$Activity_DHCPClient1 agent.pm.relayAgent.config
```

### DESCRIPTION

A DHCP client's relay agent is configured by modifying the options of the `pm.relayAgent` option of the DHCP Client Agent object.

### SUBCOMMANDS

None.

### OPTIONS

`enableRelay`

If `true`, the DHCP client will emulate DHCP relay agents. (Default = 0).

`enableCircuitId`

If `true`, the DHCP agent includes the Circuit ID sub-option in DHCP messages. Use the `circuitId` option to configure the ID value. (Default = 0).

`circuitId`

If `circuitId` is `true`, this option sets the circuit ID. You can include variables to cause the client to generate large numbers of unique values. Maximum length = 243. (Default = "123[000-999]").

`circuitIdGroupSize`

Number of DHCP clients sharing the same Circuit ID.

`enableRemoteId`

If `true`, the DHCP agent includes the Remote ID suboption in DHCP messages. Use the `remoteId` option to configure the ID value. (Default = 0).

`remoteId`

If `remoteId` is `true`, this option sets the remote ID. You can include variables to cause the client to generate large numbers of unique values. Maximum length = 243. (Default = "Ixia-host-[0000-]").

`remoteIdGroupSize`

Number of DHCP clients sharing the same Remote ID.

relayAgentIPAddr

IP address of the first emulated DHCP Relay Agent. If you specify more than Relay Agent (the numRelayAgent option), IxLoad increments this address to create additional addresses for the agents. Minimum length = 7, maximum length = 24, (Default = "11.0.0.1/8").

numRelayAgent

Number of DHCP Relay Agents to emulate. Minimum = 1, maximum = 1,000,000. (Default = 1).

### EXAMPLE

```
$Activity_DHCPCClient1 agent.pm.relayAgent.config \-remoteId
"Ixia-host-\[0000-\]" \-memRequired                0 \-circuitId
"123\[000-999\]" \-relayAgentIPAddr                "11.0.0.1/8" \-numVlans
1 \-enableRemoteId                                false \-remoteIdGroupSize
1 \-enableCircuitId                               false \-circuitIdGroupSize
1 \-enableRIdByteStream                           false \-vlanId
1 \-enableVlan                                     false \-incrVlanId
1 \-enableCIdByteStream                            false \-numRelayAgent
1 \-enableRelay                                    0
```

### SEE ALSO

[DHCP Client Agent](#)

## Option

Option—Configures a DHCP option.

### SYNOPSIS

```
set Traffic1_Network1 [::IxLoad new ixNetTraffic]
set Activity_DHCPClient1 [$Traffic1_Network1 activityList.appendItem options...]
$Activity_DHCPClient1 agent.pm.optionSetMgr.optionSetList.appendItem
$Activity_DHCPClient1 agent.pm.optionSetMgr.optionSetList(0).option
```

### DESCRIPTION

An `Option` object is an item in an `OptionsList`. An `Option` is added to an `Options List` using `appendItem`.

### SUBCOMMANDS

None.

### OPTIONS

`id`

DHCP option. One of the following:

Value	Description
RequestedIPAddress	This option is used in a client request (DHCPDISCOVER) to allow the client to request that a particular IP address be assigned.
IPAddressLeaseTime	This option is used in a client request (DHCPDISCOVER or DHCPREQUEST) to allow the client to request a lease time for the IP address. In a server reply (DHCPOFFER), a DHCP server uses this option to specify the lease time it is willing to offer.
ParameterRequestList	This option is used by a DHCP client to request values for specified configuration parameters.
DHCPErrorMessage	This option is used by a DHCP server to provide an error message to a DHCP client in a DHCPNAK message, in the event of a failure. A client may use this option in a DHCPDErrorMessage to indicate why the client declined the offered parameters.

DHCPRenewalTime	This option specifies the time interval from address assignment until the client transitions to the RENEWING state.
DHCPRebindingTime	This option specifies the time interval from address assignment until the client transitions to the REBINDING state.
VendorClassIdentifier	This option is used by DHCP clients to optionally identify the vendor type and configuration of a DHCP client.
ClientIdentifier	This option is used by DHCP clients to specify their unique identifier. DHCP servers use this value to index their database of address bindings. This value is expected to be unique for all clients in an administrative domain.
SubnetMaskValue	The subnet mask option specifies the client's subnet mask as per RFC 950.
TimeOffsetUTC	The time offset field specifies the offset of the client's subnet in seconds from Coordinated Universal Time (UTC). A positive offset indicates a location east of the zero meridian and a negative offset indicates a location west of the zero meridian.
RouterAddresses	The router option specifies a list of IP addresses for routers on the client's subnet. Enter the router addresses in order of preference.
DNSServerAddresses	The domain name server option specifies a list of Domain Name System name servers available to the client. List the servers in order of preference.
HostnameString	This option specifies the name of the client. The name may or may not be qualified with the local domain name.
DNSDomainNameClient	This option specifies the domain name that client should use when resolving hostnames via the Domain Name System.
InterfaceMTUSize	This option specifies the MTU to use on this interface. The MTU is specified as a 16-bit unsigned integer. The minimum value for MTU is 68.
SubnetsLocal	This option specifies whether or not the client may assume that all subnets of the IP network to which the client is connected use the same MTU as the subnet of that network to which the client is directly connected. If this option is enabled, that indicates that all subnets share the same MTU. If this option is disabled, that indicates that the client should assume that some subnets of the directly connected network may have smaller MTUs.
BroadcastAddress	This option specifies the broadcast address in use on the client's subnet.

PerformMaskDiscovery	This option specifies whether or not the client should perform subnet mask discovery using ICMP. If this option is disabled, then it indicates that the client should not perform mask discovery. If this option is enabled, then it indicates that the client should perform mask discovery.
PerformRouterDiscovery	This option specifies whether or not the client should solicit routers using the Router Discovery mechanism defined in RFC 1256. If this option is disabled, then it indicates that the client should not perform router discovery. If this option is enabled, then it indicates that the client should perform router discovery.
ARPCacheTimeOut	This option specifies the timeout in seconds for ARP cache entries.
VendorSpecificInfo	This option is used by clients and servers to exchange vendor information. The vendor is indicated in the vendor class identifier option.
UserClassInfo	This option is used by a DHCP client to optionally identify the type or category of user or applications it represents.

### Arguments for option = RequestedIPAddress

clientIPAddr

IP address requested by the client. Minimum length = 7, maximum length = 24. (Default = "10.0.0.1/8").

### Arguments for option = IPAddressLeaseTime

interval

Duration of lease, in seconds. Minimum = 0, maximum = 4,294,967,295. (Default = 3,600).

### Arguments for option = ParameterRequestList

options

List of options for requested parameters. This argument is a list of Option Choices objects. See `Option Choices` on page 19-35.

### Arguments for option = DHCPErrorMessage

message



---

Text of error message. Minimum length = 1, maximum length = 255. (Default = "IP Address Rejected by IxLoad").

### Arguments for option = DHCPRenewalTime

interval

Time, in seconds, from address assignment to transition to the RENEWING state. Minimum = 0, maximum = 4,294,967,295. (Default = 0).

### Arguments for option = DHCPRebindingTime

interval

Time, in seconds, from address assignment to transition to the REBINDING state. Minimum = 0, maximum = 4,294,967,295. (Default = 0).

### Arguments for option = VendorClassIdentifier

data

Text identifying vendor class. Minimum length = 1, maximum length = 255. (Default = "IXIA IxLoad DHCP Client").

### Arguments for option = ClientIdentifier

identifier

Value for client identifier. Minimum = 1, maximum = 2,147,467,647. (Default = 1).

### Arguments for option = SubnetMaskValue

mask

Subnet mask. Minimum length = 7, maximum length = 19. (Default = "255.0.0.0").

### Arguments for option = TimeOffsetUTC

offset

Offset value. Minimum = -2,147,483,648, maximum = 2,147,483,647. (Default = 0).

### Arguments for option = RouterAddresses

address

List of router IP addresses. This is a list of type `IPAddress`. `IP Address` on page 19-37. (Default = {}).

### Arguments for option = DNSServerAddresses

address

List of router IP addresses. This is a list of type `IPAddress`. `IP Address` on page 19-37. (Default = `{}`).

### Arguments for option = `HostnameString`

`hostName`

Name of the client. You can use the following characters a-z, A-Z, 0-9, dash (-). Minimum length = 1, maximum length = 53. (Default = `"IxLoad-DHCP-Cli"`).

### Arguments for option = `DNSDomainNameClient`

`domainName`

Domain name. Minimum length = 1, maximum length = 255. (Default = `"ixia"`).

### Arguments for option = `InterfaceMTUSize`

`size`

MTU value. Minimum = 68, maximum = 65,535. (Default = 68).

### Arguments for option = `SubnetsLocal`

`val`

Boolean value. 0 = false, 1 = true. (Default = 0).

### Arguments for option = `BroadcastAddress`

`address`

Broadcast IP address. Minimum length = 7, maximum length = 19. (Default = `"10.255.255.255"`).

### Arguments for option = `PerformMaskDiscovery`

`val`

Boolean value. 0 = false, 1 = true. (Default = 0).

### Arguments for option = `PerformRouterDiscovery`

`val`

Boolean value. 0 = false, 1 = true. (Default = 0).

### Arguments for option = `ARPCacheTimeOut`

`timeout`

Timeout value. Minimum = 0, maximum = 4,294,967,295. (Default = 0).

**Arguments for option = VendorSpecificInfo**

info

Text string describing vendor information. Minimum length = 1. (Default = "None").

**Arguments for option = UserClassInfo**

info

Text string describing user class information. Minimum length = "1," maximum length = "254."  
(Default = "IXIA IxLoad DHCP Client").

**EXAMPLE**

```
$Activity_DHCPCClient1 agent.pm.optionSetMgr.optionSetList.appendItem \-id
"OptionSet" \-predefined                                true \-decline
0 \-name                                                "Default Option Set for DHCPDISCOVER" \-
inUse                                                  1 \-bootRequest
0 \-bind                                                0 \-discover
true \-bindRelease                                    0 \-inform
0 \-bindRenew                                          0 \-release
0$Activity_DHCPCClient1 agent.pm.optionSetMgr.optionSetList
(0).optionsList.clear$Activity_DHCPCClient1 agent.pm.optionSetMgr.optionSetList(0).-
optionsList.appendItem \-id                            "Reques-
tedIPAddress" \-clientIPAddr                          "10.0.0.1/8"$Activity_
DHCPCClient1 agent.pm.optionSetMgr.optionSetList(0).optionsList.appendItem \-id
"IPAddressLeaseTime" \-interval                       3600
```

**SEE ALSO**

[DHCP Client Agent](#)

## Option Set

Options Set—Configures the list of commands that an option list applies to.

### SYNOPSIS

```
set Traffic1_Network1 [::IxLoad new ixNetTraffic]
set Activity_DHCPClient1 [$Traffic1_Network1 activityList.appendItem options...]
$Activity_DHCPClient1 agent.pm.optionSet.config
```

### DESCRIPTION

An `Options Set` is a list of `Options`, their arguments, and the commands for which those options are used. Configure the list using the same subcommands as for `ixConfig`.

### SUBCOMMANDS

The options for this command are configured and read using the standard `config`, `cget`, and `getOption` subcommands defined in the `ixConfig` command.

### OPTIONS

`name`

Name of option set list. Minimum length = 1. (Default = "No Name")

`optionsList`

List of options and their arguments. See `Option` on page 19-27. (Default = "{}").

`predefined`

If `true`, then the options in this option set are predefined for the DHCP server to expose as available options. (Default = "0").

`inUse`

Minimum = 0, maximum = 1. (Default = 0).

`discover`

If `true`, then this option set can be used for the DHCPDISCOVER command. (Default = 0).

`inform`

If `true`, then this option set can be used for the DHCPINFORM command. (Default = 0).

`decline`

If `true`, then this option set can be used for the DHCPDECLINE command. (Default = 0).

`release`

If `true`, then this option set can be used for the DHCPRELEASE command. (Default = 0).

bind

If true, then this option set can be used for the (Bind} command. (Default = 0).

bindRelease

If true, then this option set can be used for the BindRelease command. (Default = 0).

bindRenew

If true, then this option set can be used for the BindRenew command. (Default = 0).

bootRequest

If true, then this option set can be used for the BOOTREQUEST command. (Default = 0).

### EXAMPLE

```
$Activity_DHCPClient1 agent.pm.optionSet.config \-predefined
false \-decline                false \-name
"No Name" \-inUse              0 \-bootRequest
false \-bind                   false \-discover
false \-bindRelease            false \-inform
false \-bindRenew              false \-release
false
```

### SEE ALSO

[DHCP Client Agent](#)

## Option Set Manager

Options Set Manager—Configures the list of Option Sets.

### SYNOPSIS

```
set Traffic1_Network1 [::IxLoad new ixNetTraffic]
set Activity_DHCPClient1 [$Traffic1_Network1 activityList.appendItem options...]
$Activity_DHCPClient1 agent.pm.optionSetMgr.optionSetList.appendItem
$Activity_DHCPClient1 agent.pm.optionSetMgr.optionSetList(0).option
```

### DESCRIPTION

To configure an Option Set Manager, use the `appendItem` command on the `pm.optionSetManager` component of the DHCP Client Agent.

### SUBCOMMANDS

None.

### OPTIONS

`optionSetList`

List of Option Sets. See Option Set.

### EXAMPLE

See the example for Option.

### SEE ALSO

[DHCP Client Agent](#)

## Option Choices

Option Choices—Configures a list of DHCP options that the client agent requests values for.

### SYNOPSIS

```
set Traffic1_Network1 [::IxLoad new ixNetTraffic]
set Activity_DHCPClient1 [$Traffic1_Network1 activityList.appendItem options...]
$Activity_DHCPClient1 agent.pm.optionSetMgr.optionSetList.appendItem
$Activity_DHCPClient1 agent.pm.optionSetMgr.optionSetList(0).option
```

### DESCRIPTION

The `Option` command includes a `Parameter Request List option`. `Parameter Request List` allows the client to send a list of DHCP options to the server and request the server to return the values that it supports for each option.

To specify the list of DHCP options that the client sends, use the `optionCode` parameter of the `Options Choices` command.

### SUBCOMMANDS

The options for this command are configured and read using the standard `config`, `cget`, and `getOption` subcommands defined in the `ixConfig` command.

### OPTIONS

`optionCode`

DHCP option that the client requests values for. Minimum = 1, maximum = 59. The choices are:

Value	Description
51	(default) IP Address Lease Time
58	DHCP Renewal (T1) Time
59	DHCP Rebinding (T2) Time
1	Subnet Mask Value
2	Time Offset in Seconds from UTC
3	Router Addresses
6	DNS Server Addresses
12	Hostname String

15	DNS Domain Name of the Client
26	Interface MTU Size
27	All Subnets are Local
28	Broadcast Address
29	Perform Mask Discovery
31	Perform Router Discovery
35	ARP Cache Timeout
43	Vendor Specific Information

**SEE ALSO**

[Option](#)



## IP Address

IP Address—Configures a list of IP addresses.

### SYNOPSIS

```
set Traffic1_Network1 [::IxLoad new ixNetTraffic]
set Activity_DHCPClient1 [$Traffic1_Network1 activityList.appendItem options...]
$Activity_DHCPClient1 agent.pm.optionSetMgr.optionSetList(0).option
```

### DESCRIPTION

Several DHCP Option commands includes options (RouterAddresses, DNSServ) that specify lists of IP addresses for various functions. To create those lists, you use IP Address, which is a list of type ixConfigSequenceContainer. Each element in the list is an IP address.

### SUBCOMMANDS

None.

### OPTIONS

address

IP address. Minimum length = 7, maximum length = 19. (Default = "0.0.0.0").

### EXAMPLE

```
# Create a list of IP addresses
set ipAddrList [list \
    "198.18.0.1" \
    "10.205.17.71" \
    "10.205.17.176" \
    "198.18.0.101" \
]# Go through the following loop adding the addresses one by one.
foreach {option id}
[list RouterAddresses addresses DNSServerAddresses addresses] {

    $clnt_traffic agentList(0).pm.optionSetMgr.optionSetList(0) \
.optionsList.appendItem \
-id $option

set index [$clnt_traffic agentList(0).pm.optionSetMgr.optionSetList(0) \
.optionsList.indexCount]
incr index -1
foreach ip $ipAddrList {

$clnt_traffic agentList(0).pm.optionSetMgr.optionSetList(0) \
.optionsList($index).${id}.appendItem \
-address $ip
}
}
```

### SEE ALSO

[ixConfigSequenceContainer](#)

## Using Variables in DHCP Fields

You can insert variables into the Circuit ID and Remote ID fields on the DHCP client Relay Agent tab. You can use the variables to generate large numbers of unique circuit IDs and remote IDs.

You can use the following variables:

- Numbers 0-9
- Letters A-Z and a-z

The letter variables are case-sensitive; IxLoad considers the variable strings "AA" and "aa" to be different.

You can combine the variables with fixed text to create the circuit IDs and remote IDs. For example, you can enter `circuitID_[00-]` to create a range of unique IDs that begin with the characters "circuitID\_" (circuitID\_00, circuitID\_01, and so on).

To insert the variables into a field, enclose them in square brackets ( [ ] ). To specify a range, separate the minimum and maximum values with a hyphen (-). For example, `[00-10]` specifies a range of 00 through 10.

The number of variables you insert determines the width of the generated strings. For example, the variable "00" can generate the strings 00 - 99. The variable string "000" can generate the strings 000 - 999.

Similarly, "AA" can generate strings that consist of all the two-letter combinations from AA to ZZ. "AAA" can generate strings that consist of all the three-letter combinations from AAA to ZZZ.

You can use a single variable string and allow IxLoad to generate strings up to the maximum value of the string or, you can use two variable strings together to restrict the generated strings to a certain range.

See the following example:

`[0- ]` will generate all the values 0 - 9 (0, 1, 2, 3 . . . 9).

`[0-5]` will generate all the values 0 - 5.

`[00- ]` will generate all the values 00 - 99 (00, 01, 02, 03. . .97, 98, 99).

`[00-50]` will generate all the values 0 - 50.

`[A- ]` will generate all the values A - Z (A, B, C . . . Z).

`[A-K]` will generate all the values A - K.

`[AA- ]` will generate all the values AA - ZZ (AA, AB, AC. . ZX, ZY, ZZ).

`[AA-KK]` will generate all the values AA - KK.

When IxLoad has generated the final string, if the test configuration requires additional strings, IxLoad returns to the starting value of the variable and continues to generate strings until no more are required. In this case, the generated strings will not be unique.

For example, if a DHCP test requires 256 circuit IDs and the Circuit ID field is configured as:

```
circuitID_[00-]
```

IxLoad will generate the strings circuitID\_00 - circuitID\_99, then repeat and again generate strings circuitID\_00 - circuitID\_99, then generate the final group of strings circuitID\_00 - circuitID\_56.

## DHCP Statistics

The table below describes the DHCP client statistics.

For information on how the various DHCP options affect the size of a DHCP packet generated by IxLoad, see [Effect of Options on DHCP Packet Size](#) (see [Effect of Options on DHCP Packet Size](#)).

Statistic	Description
DHCP DHCPDISCOVER Response Time	Amount of time elapsed between the time the client sent a DHCPDISCOVER request and the time it received an acceptable response to it. This statistic is updated when the client selects a DHCPOFFER, which can be affected by the server selection algorithm.  Note for Tcl API users: This is a weighted statistic. If you are using this statistic in a Tcl script, use the <i>kWeightedAverage</i> aggregation type.
DHCP DHCPPREREQUEST Response Time	Amount of time elapsed between the time the client sent a DHCPPREREQUEST request and the time it received the first response to it.  Note for Tcl API users: This is a weighted statistic. If you are using this statistic in a Tcl script, use the <i>kWeightedAverage</i> aggregation type.
DHCP DHCPPREREQUEST (SELECTING) Response Time	Amount of time elapsed between the time the client sent a DHCPPREREQUEST request in the Selecting state and the time it received the first response to it.  Note for Tcl API users: This is a weighted statistic. If you are using this statistic in a Tcl script, use the <i>kWeightedAverage</i> aggregation type.
DHCP DHCPPREREQUEST (INIT-REBOOT) Response Time	Amount of time elapsed between the time the client sent a DHCPPREREQUEST request in the Init-Reboot state and the time it received the first response to it.  Note for Tcl API users: This is a weighted statistic. If you are using this statistic in a Tcl script, use the <i>kWeightedAverage</i> aggregation type.
DHCP DHCPPREREQUEST (RENEWING) Response Time	Amount of time elapsed between the time the client sent a DHCPPREREQUEST request in the Renewing state and the time it received the first response to it.  Note for Tcl API users: This is a weighted statistic. If you are using this statistic in a Tcl script, use the <i>kWeightedAverage</i> aggregation type.
DHCP DHCPPREREQUEST (REBINDING) Response Time	Amount of time elapsed between the time the client sent a DHCPPREREQUEST request in the Rebinding state and the time it received the first response to it.  Note for Tcl API users: This is a weighted statistic. If you are using this statistic in a Tcl script, use the <i>kWeightedAverage</i> aggregation type.

DHCP DHCPINFORM Response Time	Amount of time elapsed between the time the client sent a DHCPINFORM request and the time it received the first response to it. Note for Tcl API users: This is a weighted statistic. If you are using this statistic in a Tcl script, use the <i>kWeightedAverage</i> aggregation type.
DHCP BOOTREQUEST Response Time	Amount of time elapsed between the time the client sent a BOOTREQUEST request and the time it received the first response to it. Note for Tcl API users: This is a weighted statistic. If you are using this statistic in a Tcl script, use the <i>kWeightedAverage</i> aggregation type.
DHCP Total Com- mands Sent	Total number of commands sent by the client. Composite commands such as {Bind} are counted according to the number of actual DHCP commands they generate. For example, {Bind} normally generates two commands (DHCPDISCOVER and DHCPREQUEST) but it may generate three if it also sends a DHCPDECLINE.
DHCP Total Com- mands Succeeded	Total number of commands sent by the client that succeeded.
DHCP Total Com- mands Failed	Total number of commands sent by the client that failed for all reasons.
DHCP Total Com- mands Failed (NAK Received)	Total number of commands sent by the client that failed because it received a NAK response.
DHCP Total Com- mands Failed (Timeout)	Total number of commands sent by the client that failed because it did not receive a response within the timeout period.
DHCP Total Com- mands Failed (Error)	Total number of commands sent by the client that failed because an error other than a timeout or NAK occurred.
DHCP Total Com- mands Retrans- mitted	Total number of commands that the client retransmitted.
DHCP Total Responses Matched	Total number of responses received by the client in which the options in the response matched those it expected to receive. The expected options are provided on the Expected Options tab. If you provide a set of expected values or the server sends a set of values, a match between any of the expected values and received values is treated as success.

DHCP Total Responses Mismatched	Total number of responses received by the client in which the options in the response did not match those it expected to receive.
DHCP DHCPDISCOVER Commands Sent	Total number of DHCPDISCOVER commands sent by the client.
DHCP DHCPDISCOVER Commands Succeeded	Total number of DHCPDISCOVER commands that succeeded.
DHCP DHCPDISCOVER Commands Failed	Total number of DHCPDISCOVER commands that failed for all reasons.
DHCP DHCPDISCOVER Commands Failed (Timeout)	Total number of DHCPDISCOVER commands that failed because the client did not receive a response within the timeout period.
DHCP DHCPDISCOVER Commands Failed (Error)	Total number of DHCPDISCOVER commands that failed because an error other than a NAK or timeout occurred.
DHCP DHCPDISCOVER Commands Retransmitted	Total number of DHCPDISCOVER commands that the client retransmitted.
DHCP DHCPDISCOVER Responses Matched	Total number of DHCPDISCOVER responses received by the client in which the options matched those that it expected to receive.
DHCP DHCPDISCOVER Responses Mismatched	Total number of DHCPDISCOVER responses received by the client in which the options did not match those that it expected to receive.
DHCP DHCPREQUEST Commands Sent	Total number of DHCPREQUEST commands sent by the client.

DHCP DHCPREQUEST Commands Succeeded	Total number of DHCPREQUEST commands that succeeded.
DHCP DHCPREQUEST Commands Failed	Total number of DHCPREQUEST commands that failed for all reasons.
DHCP DHCPREQUEST Commands Failed (NAK Received)	Total number of commands sent by the client that failed because it received a NAK response.
DHCP DHCPREQUEST Commands Failed (Timeout)	Total number of DHCPREQUEST commands that failed because the client did not receive a response within the timeout period.
DHCP DHCPREQUEST Commands Failed (Error)	Total number of DHCPREQUEST commands that failed because an error other than a NAK or timeout occurred.
DHCP DHCPREQUEST Commands Retransmitted	Total number of DHCPREQUEST commands that the client retransmitted.
DHCP DHCPREQUEST Responses Matched	Total number of DHCPREQUEST responses received by the client in which the options matched those that it expected to receive.
DHCP DHCPREQUEST Responses Mismatched	Total number of DHCPREQUEST responses received by the client in which the options did not match those that it expected to receive.
DHCP DHCPREQUEST (SELECTING) Commands Sent	Total number of DHCPREQUEST commands sent by the client while it was in the Selecting state.

DHCP DHCPREQUEST (SELECTING) Com- mands Succeeded	Total number of DHCPREQUEST commands sent by the client while it was in the Selecting state that succeeded.
DHCP DHCPREQUEST (SELECTING) Com- mands Failed	Total number of DHCPREQUEST commands sent by the client while it was in the Selecting state that failed for all reasons.
DHCP DHCPREQUEST (SELECTING) Com- mands Failed (NAK Received)	Total number of DHCPREQUEST commands sent by the client while it was in the Selecting state that failed because the client received a NAK response.
DHCP DHCPREQUEST (SELECTING) Com- mands Failed (Timeout)	Total number of DHCPREQUEST commands sent by the client while it was in the Selecting state that failed because the client did not receive a response within the timeout period.
DHCP DHCPREQUEST (SELECTING) Com- mands Failed (Error)	Total number of DHCPREQUEST commands sent by the client while it was in the Selecting state that failed because an error other than a NAK or timeout occurred.
DHCP DHCPREQUEST (SELECTING) Com- mands Retrans- mitted	Total number of DHCPREQUEST commands sent by the client while it was in the Selecting state that the client retransmitted.
DHCP DHCPREQUEST (SELECTING) Responses Matched	Total number of DHCPREQUEST responses received by the client while it was in the Selecting state in which the options matched those that it expected to receive.
DHCP DHCPREQUEST (SELECTING) Responses Mis- matched	Total number of DHCPREQUEST responses received by the client while it was in the Selecting state in which the options did not match those that it expected to receive.



DHCP DHCPREQUEST (INIT-REBOOT) Commands Sent	Total number of DHCPREQUEST commands sent by the client while it was in the Init-Reboot state.
DHCP DHCPREQUEST (INIT-REBOOT) Commands Succeeded	Total number of DHCPREQUEST commands sent by the client while it was in the Init-Reboot state that succeeded.
DHCP DHCPREQUEST (INIT-REBOOT) Commands Failed	Total number of DHCPREQUEST commands sent by the client while it was in the Init-Reboot state that failed for all reasons.
DHCP DHCPREQUEST (INIT-REBOOT) Commands Failed (NAK Received)	Total number of DHCPREQUEST commands sent by the client while it was in the Init-Reboot state that failed because the client received a NAK response.
DHCP DHCPREQUEST (INIT-REBOOT) Commands Failed (Timeout)	Total number of DHCPREQUEST commands sent by the client while it was in the Init-Reboot state that failed because the client did not receive a response within the timeout period.
DHCP DHCPREQUEST (INIT-REBOOT) Commands Failed (Error)	Total number of DHCPREQUEST commands sent by the client while it was in the Init-Reboot state that failed because an error other than a NAK or timeout occurred.
DHCP DHCPREQUEST (INIT-REBOOT) Commands Retransmitted	Total number of DHCPREQUEST commands sent by the client while it was in the Init-Reboot state that the client retransmitted.
DHCP DHCPREQUEST (INIT-REBOOT) Responses Matched	Total number of DHCPREQUEST responses received by the client while it was in the Init-Reboot state in which the options matched those that it expected to receive.

DHCP DHCPREQUEST (INIT-REBOOT) Responses Mis- matched	Total number of DHCPREQUEST responses received by the client while it was in the Init-Reboot state in which the options did not match those that it expected to receive.
DHCP DHCPREQUEST (RENEWING) Com- mands Sent	Total number of DHCPREQUEST commands sent by the client while it was in the Renewing state.
DHCP DHCPREQUEST (RENEWING) Com- mands Succeeded	Total number of DHCPREQUEST commands sent by the client while it was in the Renewing state that succeeded.
DHCP DHCPREQUEST (RENEWING) Com- mands Failed	Total number of DHCPREQUEST commands sent by the client while it was in the Renewing state that failed for all reasons.
DHCP DHCPREQUEST (RENEWING) Com- mands Failed (NAK Received)	Total number of DHCPREQUEST commands sent by the client while it was in the Renewing state that failed because the client received a NAK response.
DHCP DHCPREQUEST (RENEWING) Com- mands Failed (Timeout)	Total number of DHCPREQUEST commands sent by the client while it was in the Renewing state that failed because the client did not receive a response within the timeout period.
DHCP DHCPREQUEST (RENEWING) Com- mands Failed (Error)	Total number of DHCPREQUEST commands sent by the client while it was in the Renewing state that failed because an error other than a NAK or timeout occurred.
DHCP DHCPREQUEST (RENEWING) Com- mands Retrans- mitted	Total number of DHCPREQUEST commands sent by the client while it was in the Renewing state that the client retransmitted.

DHCP DHCPREQUEST (RENEWING) Responses Matched	Total number of DHCPREQUEST responses received by the client while it was in the Renewing state in which the options matched those that it expected to receive.
DHCP DHCPREQUEST (RENEWING) Responses Mis- matched	Total number of DHCPREQUEST responses received by the client while it was in the Renewing state in which the options did not match those that it expected to receive.
DHCP DHCPREQUEST (REBINDING) Com- mands Sent	Total number of DHCPREQUEST commands sent by the client while it was in the Rebinding state.
DHCP DHCPREQUEST (REBINDING) Com- mands Succeeded	Total number of DHCPREQUEST commands sent by the client while it was in the Rebinding state that succeeded.
DHCP DHCPREQUEST (REBINDING) Com- mands Failed	Total number of DHCPREQUEST commands sent by the client while it was in the Rebinding state that failed for all reasons.
DHCP DHCPREQUEST (REBINDING) Com- mands Failed (NAK Received)	Total number of DHCPREQUEST commands sent by the client while it was in the Rebinding state that failed and for which the client received a NAK response.
DHCP DHCPREQUEST (REBINDING) Com- mands Failed (Timeout)	Total number of DHCPREQUEST commands sent by the client while it was in the Rebinding state that failed because the client did not receive a response within the timeout period.
DHCP DHCPREQUEST (REBINDING) Com- mands Failed (Error)	Total number of DHCPREQUEST commands sent by the client while it was in the Rebinding state that failed because an error other than a NAK or timeout occurred.

DHCP DHCPREQUEST (REBINDING) Com- mands Retrans- mitted	Total number of DHCPREQUEST commands sent by the client while it was in the Rebinding state that the client retransmitted.
DHCP DHCPREQUEST (REBINDING) Responses Matched	Total number of DHCPREQUEST responses received by the client while it was in the Rebinding state in which the options matched those that it expected to receive.
DHCP DHCPREQUEST (REBINDING) Responses Mis- matched	Total number of DHCPREQUEST responses received by the client while it was in the Rebinding state in which the options did not match those that it expected to receive.
DHCP DHCPDECLINE Com- mands Sent	Total number of DHCPDECLINE commands sent by the client.
DHCP DHCPDECLINE Com- mands Send Failed	Total number of DHCPDECLINE commands that failed for all reasons.
DHCP DHCPRELEASE Com- mands Sent	Total number of DHCPRELEASE commands sent by the client.
DHCP DHCPRELEASE Com- mands Send Failed	Total number of DHCPRELEASE commands that failed for all reasons.
DHCP DHCPINFORM Com- mands Sent	Total number of DHCPINFORM commands sent by the client.
DHCP DHCPINFORM Com- mands Succeeded	Total number of DHCPINFORM commands that succeeded.
DHCP DHCPINFORM Com- mands Failed	Total number of DHCPINFORM commands that failed for all reasons.

DHCP DHCPINFORM Com- mands Failed (Timeout)	Total number of DHCPINFORM commands that failed because the client did not receive a response within the timeout period.
DHCP DHCPINFORM Com- mands Failed (Error)	Total number of DHCPINFORM commands that failed because an error other than a NAK or timeout occurred.
DHCP DHCPINFORM Com- mands Retrans- mitted	Total number of DHCPINFORM commands that the client retransmitted.
DHCP DHCPINFORM Responses Matched	Total number of DHCPINFORM responses received by the client in which the options matched those that it expected to receive.
DHCP DHCPINFORM Responses Mis- matched	Total number of DHCPINFORM responses received by the client in which the options did not match those that it expected to receive.
DHCP BOOTREQUEST Commands Sent	Total number of BOOTREQUEST commands sent by the client.
DHCP BOOTREQUEST Commands Suc- ceeded	Total number of BOOTREQUEST commands that succeeded.
DHCP BOOTREQUEST Commands Failed	Total number of BOOTREQUEST commands that failed for all reasons.
DHCP BOOTREQUEST Commands Failed (Timeout)	Total number of BOOTREQUEST commands that failed because the client did not receive a response within the timeout period.
DHCP BOOTREQUEST Commands Failed (Error)	Total number of BOOTREQUEST commands that failed because an error other than a NAK or timeout occurred.

DHCP BOOTREQUEST Commands Retransmitted	Total number of BOOTREQUEST commands that the client retransmitted.
DHCP BOOTREQUEST Responses Matched	Total number of BOOTREQUEST responses received by the client in which the options matched those that it expected to receive.
DHCP BOOTREQUEST Responses Mismatched	Total number of BOOTREQUEST responses received by the client in which the options did not match those that it expected to receive.
DHCP Total Number of DHCPOFFER Messages	Total number of DHCPOFFER commands received by the client.
DHCP Number of DHCPOFFER Messages Ignored	Total number of DHCPOFFER messages that the client ignored.
DHCP Total Number of DHCPACK Messages	Total number of DHCPACK commands received by the client.
DHCP Number of DHCPACK Messages Ignored	Total number of DHCPACK messages that the client ignored.
DHCP Total Number of DHCPNAK Messages	Total number of DHCPNAK messages received by the client.
DHCP Number of DHCPNAK Messages Ignored	Total number of DHCPNAK messages that the client ignored.
DHCP ICMP Echo Messages Received	Total number of ICMP Echo (ping) messages received by the client.
DHCP ICMP Echo Reply Messages Sent	Total number of ICMP Echo (ping) reply messages sent by the client.

DHCP ARP Request Messages Received	Total number of ARP requests received by the client.
DHCP ARP Reply Messages Sent	Total number of ARP replies sent by the client.
DHCP Valid IP Addresses Received	Total number of valid IP addresses received by the client.
DHCP Duplicate IP Addresses Received	Total number of duplicate IP addresses received by the client.
DHCP User Count	Number of DHCP users simulated by the client.
DHCP Total Transaction	Total number of DHCP transactions completed by the client. <b>Note:</b> DHCPRELEASE and DHCPDECLINE do not contribute to this statistic.
DHCP Number of Active Leases	Total number of IP address leases received that have not expired, been released (by sending DHCPRELEASE), or been declined (by sending DHCPDECLINE).
DHCP Number of Leases Expired	Total number of IP address leases that have expired.
DHCP Number of Clients Awaiting IP Address from Server	Total number of DHCP clients waiting to receive IP addresses from a server.
DHCP Total Bytes Transmitted	Total number bytes transmitted by the client. <b>Note:</b> All of the "Total Bytes" statistics count all the bytes in the packet, including the UDP and IP headers.
DHCP Total Bytes Received	Total number of bytes received by the client.
DHCP Total Bytes Transmitted and Received	Combined total of bytes transmitted and received by the client.

## Effect of Options on DHCP Packet Size

The table below describes how the various DHCP options affect the size of a DHCP packet generated by IxLoad.

Description	Bytes
Size of headers and other fixed fields:	278
If "Allow Options Overload" is enabled, number of bytes added regardless of whether IxLoad actually overloads the options or not:	3
If the Maximum DHCP Message Size option is enabled, number of bytes added to a DHCP (not BOOTP) packet:	4
Number of bytes added for each option in the Option set used by a particular command:	Size of the option, including code, len, and data fields.
If the Host Name option is enabled, number of bytes added to the size of the (user-specified) data:	10
<b>Note:</b> If all options cannot fit into the packet and "Allow Options Overload" is enabled, IxLoad first tries to fit the extra options into "file" field of the DHCP packet header, and then into the "sname" field. Options that are placed in the "file" or the "sname" fields do not contribute to the packet size calculation.	



# DNS

This section describes the DNS Tcl API objects.

## Overview

DNS protocol commands are organized as a simple structure.

```
DNS Client Agent
DNS Client Query
DNS Client Advanced Options
- DNS Server Agent
- DNS Server Zone Management
- DNS Server Zone Configuration
- DNS Server Advanced Options
- DNS Server Resource Records
```

## Objectives

The objectives (userObjective) you can set for DNS are listed below. Test objecare set in the ixTimeline object.

- simulatedUsers
- transactionRate
- throughputKBps
- transactionAttemptRate (displays as "Queries/Second" in the GUI)

## DNS Client Agent

DNS Client Agent - configure a DNS client

### SYNOPSIS

```
set Traffic1_Network1 [::IxLoad new ixNetTraffic]
set Activity_DNSClient1 [$Traffic1_Network1 activityList.appendItem
$Activity_DNSClient1 agent.config
```

### DESCRIPTION

A DNS client agent is added to the `activityList` object. The `activityList` object is added to the `ixNetTraffic` object using the `appendItem` subcommand from the `ixConfigSequenceContainer` command.

### SUBCOMMANDS

None.

### OPTIONS

`enable`

Enables the use of this agent. (Default = true).

`name`

The name associated with this object, which must be set at object creation time.

### STATISTICS

#### EXAMPLE

```
set Traffic1_Network1 [::IxLoad new
ixNetTraffic]##### Activity DNSClient1
of NetTraffic Traffic1@Network1#####set
Activity_DNSClient1 [$Traffic1_Network1 activityList.appendItem \-protocolAndType
"DNS Client" ]##### Timeline1 for activ-
ities DNSClient1#####set Timeline1
[::IxLoad new ixTimeline]$Timeline1 config \-rampUpValue
1 \-rampUpType 0 \-offlineTime
0 \-rampDownTime 20 \-standbyTime
0 \-iterations 1 \-rampUpInterval
1 \-sustainTime 20 \-timelineType
0 \-name "Timeline1"$Activity_DNSClient1 config
\-enable true \-name
"DNSClient1" \-enableConstraint false \-userObjectiveValue
100 \-constraintValue 100 \-userObjectiveType
```

```

"simulatedUsers" \-timeline                                $Timeline1$Activity_
DNSClient1 agent.config \-enable                          true \-name
"DNSClient1"$Activity_DNSClient1 agent.pm.advancedOptions.config \-
lowerLayerTransport 1 \-noWaitForResp
false \-version 0 \-responseTimeout
20 \-implicitLoopCheck true \-numberOfRetries
3$Activity_DNSClient1 agent.pm.seqGenExample.config \-dummy
"$Activity_DNSClient1 agent.pm.dnsConfig.dnsQueries.clear$Activity_DNSClient1
agent.pm.dnsConfig.dnsQueries.appendItem \-id
"DnsQuery" \-expect "" \-hostName
"localhost" \-queryType "A" \-recursionDesired
0 \-dnsServer "Traffic2_DNSServer1:53"

```

**SEE ALSO**[DNS Client Query](#)[DNS Client Advanced Options](#)[ixNetTraffic](#)

## DNS Client Query

DNS Client Query - configure a DNS query that the client will send

### SYNOPSIS

```
set Traffic1_Network1 [::IxLoad new ixNetTraffic]
set Activity_DNSClient1 [$Traffic1_Network1 activityList.appendItem
$Activity_DNSClient1 agent.pm.dnsConfig.dnsQueries.appendItem
```

### DESCRIPTION

A DNS client query is added to the `pm.dnsConfig.dnsQueries` option of the `DNS Client Agent` object using its `appendItem`.

Each member of the list, however may be separately addressed and modified using the `ixConfig` sub-commands.

### SUBCOMMANDS

None.

### OPTIONS

`dnsServer`

The name of the DNS server to be queried. (Default = 'None').

`expect`

The expected answer for the query; optional. (Default = "").

`enableDNSSEC`

Enable DNSSEC. Default = 0 (false).

`hostName`

The host name to be queried for. (Default = 'localhost'). If the `queryType` option is `ENUM` then the `hostName` option accepts only integers. You can use both independent and interdependent sequence generators if the `queryType` option is `ENUM`. See the `Automatic Sequence Generators` appendix for more information.

`loopValue`

If this option is enabled (1), then the client progresses through the command list repeatedly until the test's sustain time. If the option is disabled (0), then the client will progress through the command list only once, and then go idle. (Default = 0).

`publicKeyPath`

Path to DNSSEC public encryption key file. (Default = "publickeys").

`queryType`

The type of query to be performed. One of:

option	Usage
"A"	(default) An Address query.
"AAAA"	An IPV6 address retrieval query
"NS"	A Name Server query.
"CNAME"	A CName query.
"SOA"	A Start Of Authority query.
"PTR"	A Pointer query.
"MX"	A Mail eXchanger query.
"ENUM"	A query that resolves fully qualified telephone numbers to fully qualified domain name addresses.

`recursionDesired`

Indicates whether DNS referrals are to be followed or not. (Default = false).

#### EXAMPLE

```
$Activity_DNSClient1 agent.pm.dnsConfig.dnsQueries.appendItem \-id
"DnsQuery" \-expect          "" \-hostName
"localhost" \-queryType      "A" \-recursionDesired
0 \-dnsServer                "Traffic2_DNSServer1:53"
```

#### SEE ALSO

[DNS Client Agent](#)

## DNS Client Advanced Options

DNS Client Advanced Options - configure the DNS client's advanced options

### SYNOPSIS

```
set Traffic1_Network1 [::IxLoad new ixNetTraffic]
set Activity_DNSClient1 [$Traffic1_Network1 activityList.appendItem
$Activity_DNSClient1 agent.pm.advancedOptions.config
```

### DESCRIPTION

DNS advanced options are set through the `pm.advancedOptions` option of the `DNS Client Agent` object.

### SUBCOMMANDS

None.

### OPTIONS

`lowerLayerTransport`

The type of IP transport to be used for the queries in this client. One of:

option	Usage
"TCP"	TCP.
"UDP"	(default) UDP. The number of retries is only configurable for this option.

`numberOfRetries`

If `lowerLayerTransport` is `true`, this is the number of retries for the query. (Default = 3).

`responseTimeout`

The time, expressed in seconds, to wait for a DNS server response. (Default = 20).

`noWaitForResp`

This option accepts boolean value, `true` or `false`. This parameter is only effective when you set the client's `userObjectiveType` to `queriesPerSecond`. If `true`, the client does not wait for a response before sending the next query. Besides, fewer simulated users are created, and a higher `objectiveValue` (more `queriesPerSecond`) are likely to be achieved.

If `false`, the client waits for a response before sending the next query. More simulated users are created, and a lower `objectiveValue` (fewer `queriesPerSecond`) are likely to be achieved.

### EXAMPLE

```
$Activity_DNSClient1 agent.pm.advancedOptions.config \-lowerLayerTransport
```

```
1 \-noWaitForResp  
0 \-responseTimeout  
true \-numberOfRetries
```

```
false \-version  
20 \-implicitLoopCheck  
3
```

**SEE ALSO**

[DNS Client Agent](#)

## DNS Server Agent

DNS Server Agent - configure a DNS server

### SYNOPSIS

```
set Traffic2_Network2 [::IxLoad new ixNetTraffic]
set Activity_DNSServer1 [$Traffic2_Network2 activityList.appendItem
$Activity_DNSServer1 agent.config
```

### DESCRIPTION

A DNS server agent is added to the `activityList` object. The `activityList` object is added to the `ixNetTraffic` object using the `appendItem` subcommand from the `ixConfigSequenceContainer` command.

### SUBCOMMANDS

The options for this command are configured and read using the standard `config`, `cget`, and `getOption` subcommands defined in the `ixConfig` command.

### OPTIONS

`enable`

Enables the use of this action. (Default = true).

`name`

The name associated with this object, which must be set at object creation time.

### STATISTICS

### EXAMPLE

```
set Traffic2_Network2 [::IxLoad new
ixNetTraffic]##### Activity_DNSServer1
of NetTraffic Traffic2@Network2#####set
Activity_DNSServer1 [$Traffic2_Network2 activityList.appendItem \-protocolAndType
"DNS Server" ]set _Match_Longest_ [::IxLoad new ixMatchLongestTimeline]$Activity_
DNSServer1 config \-enable true \-name
"DNSServer1" \-timeline $_Match_Longest_$Activity_
DNSServer1 agent.config \-enable true \-name
"DNSServer1"$Activity_DNSServer1 agent.pm.zoneConfig.zoneList.clear$Activity_
DNSServer1 agent.pm.zoneConfig.zoneList.appendItem \-id
"ZoneList" \-name "ixiacom.com"$Activity_
DNSServer1 agent.pm.advancedOptions.config \-listeningPort
53$Activity_DNSServer1 agent.pm.zoneMgr.zoneChoices.clear$Activity_DNSServer1
agent.pm.zoneMgr.zoneChoices.appendItem \-id
```



```

"Zone" \-predefine true \-serial
1234 \-expire 8888 \-name
"localhost" \-masterServer "ixia-dns-tester"$Activity_
DNSServer1 agent.pm.zoneMgr.zoneChoices(0).resourceRecordList.clear$Activity_
DNSServer1 agent.pm.zoneMgr.zoneChoices(0).resourceRecordList.appendItem \-id
"A" \-hostName "localhost" \-address
"127.0.0.1"$Activity_DNSServer1 agent.pm.zoneMgr.zoneChoices(0).re-
sourceRecordList.appendItem \-id "A" \-hostName
"host1" \-address "198.18.0.1"$Activity_DNSServer1
agent.pm.zoneMgr.zoneChoices(0).resourceRecordList.appendItem \-id
"NS" \-nameServer "198.18.0.2" \-zoneName
"localhost"$Activity_DNSServer1 agent.pm.zoneMgr.zoneChoices.appendItem \-id
"Zone" \-predefine true \-serial
1234 \-expire 8888 \-name
"ixiacom.com" \-masterServer "ixia-dns-tester"$Activity_
DNSServer1 agent.pm.zoneMgr.zoneChoices(1).resourceRecordList.clear$Activity_
DNSServer1 agent.pm.zoneMgr.zoneChoices(1).resourceRecordList.appendItem \-id
"A" \-hostName "puppy1" \-address
"198.18.1.100"$Activity_DNSServer1 agent.pm.zoneMgr.zoneChoices(1).re-
sourceRecordList.appendItem \-id "A" \-hostName
"drowzee" \-address "198.18.1.200"$Activity_
DNSServer1 agent.pm.zoneMgr.zoneChoices(1).resourceRecordList.appendItem \-id
"CNAME" \-name "testName" \-realName
"realName"$Activity_DNSServer1 agent.pm.zoneMgr.zoneChoices(1).re-
sourceRecordList.appendItem \-id "NS" \-
nameServer "198.18.0.2" \-zoneName
"ixiacom.com"

```

**SEE ALSO**[DNS Server Zone Management](#)[DNS Server Zone Configuration](#)[DNS Server Advanced Options](#)

## DNS Server Zone Management

DNS Server Zone Management - manage the DNS zones that the server is authoritative for

### SYNOPSIS

```
set Traffic2_Network2 [::IxLoad new ixNetTraffic]
set Activity_DNSServer1 [$Traffic2_Network2 activityList.appendItem
$Activity_DNSServer1 agent.pm.zoneMgr.zoneChoices.appendItem
```

### DESCRIPTION

Each DNS server zone management list item represents a DNS domain that may be enabled by inclusion in the `zoneConfig` list of the `- DNS Server Agent` command (see the example below).

### SUBCOMMANDS

None.

### OPTIONS

`expire`

The expiration of the Start of Authority (SOA). (Default = 8,888).

`masterServer`

The master server IP address. (Default = "ixia-dns-tester").

`name`

The name of the domain, for example, "ixiacom.com." (Default = "Zone0").

`resourceRecordList`

This is a list of type `ixConfigSequenceContainer` used to hold DNS Server Resource Record objects. The elements in this list describe a DNS resource record. (Default = {}).

`serial`

The serial number for the SOA. (Default = "1234").

### EXAMPLES

```
$Activity_DNSServer1 agent.pm.zoneMgr.zoneChoices.appendItem \-id
"Zone" \-predefine true \-serial
1234 \-expire 8888 \-name
"ixiacom.com" \-masterServer "ixia-dns-tester"$Activity_
DNSServer1 agent.pm.zoneMgr.zoneChoices(1).resourceRecordList.clear$Activity_
DNSServer1 agent.pm.zoneMgr.zoneChoices(1).resourceRecordList.appendItem \-id
"A" \-hostName "puppy1" \-address
"198.18.1.100"$Activity_DNSServer1 agent.pm.zoneMgr.zoneChoices(1).re-
sourceRecordList.appendItem \-id "A" \-hostName
```

---

```
"drowzee" \-address "198.18.1.200"$Activity_
DNSServer1 agent.pm.zoneMgr.zoneChoices(1).resourceRecordList.appendItem \-id
"CNAME" \-name "testName" \-realName
"realName"$Activity_DNSServer1 agent.pm.zoneMgr.zoneChoices(1).re-
sourceRecordList.appendItem \-id "NS" \-
nameServer "198.18.0.2" \-zoneName
"ixiacom.com"
```

**SEE ALSO**

[DNS Server Agent](#)

[DNS Server Resource Record](#)

## DNS Server Zone Configuration

DNS Server Zone Configuration - setup the zones that the DNS server is authoritative for

### SYNOPSIS

```
set Traffic2_Network2 [::IxLoad new ixNetTraffic]
set Activity_DNSServer1 [$Traffic2_Network2 activityList.appendItem
$Activity_DNSServer1 agent.pm.zoneConfig.zoneList.appendItem
```

### DESCRIPTION

Each DNS server zone configuration list item represents a DNS domain that the server will respond to.

### SUBCOMMANDS

None.

### OPTIONS

name

The name of the domain, for example, "ixiacom.com." (Default = "Zone0").

id

ID of the list of zones. (Default = "ZoneList")

signedzone

Enables DNSSEC signing (encryption) for the zone. (Default = false)

keylength

Length of the key used to sign the zone. (Min="512" max="4096" default="512")

algorithm

Encryption algorithm used to sign the zone. One of the following:

"RSASHA1" (Default) "RSASHA256" "RSASHA512" "RSAMD5" "DSA"

### EXAMPLES

```
$Activity_DNSServer1 agent.pm.zoneConfig.zoneList.clear
```

```
$Activity_DNSServer1 agent.pm.zoneConfig.zoneList.appendItem \
-id "ZoneList" \
```

```
-signedzone true \
```

```
-keylength 512 \
```

```
-name "ixiacom.com" \
```

-algorithm "RSASHA1"

**SEE ALSO**

[DNS Server Agent](#)

[DNS Server Resource Record](#)

## DNS Server Advanced Options

DNS Server Advanced Options

### SYNOPSIS

```
set Traffic2_Network2 [::IxLoad new ixNetTraffic]
set Activity_DNSServer1 [$Traffic2_Network2 activityList.appendItem
$Activity_DNSServer1 agent.pm.advancedOptions.config
```

### DESCRIPTION

DNS server advanced options are set through the `pm.advancedOptions` option of the `DNS Server Agent` object.

### SUBCOMMANDS

None.

### OPTIONS

`enableDNSSEC`

Enable DNSSEC. (Default = 0 (false))

`listenPort`

The port number that the server listens on for TCP and UDP requests. (Default = 53)

### EXAMPLE

```
set Traffic2_Network2 [::IxLoad new
ixNetTraffic]##### Activity_DNSServer1
of NetTraffic Traffic2@Network2#####set
Activity_DNSServer1 [$Traffic2_Network2 activityList.appendItem \-protocolAndType
"DNS Server" ]$Activity_DNSServer1 agent.config \-enable
true \-name "DNSServer1"$Activity_DNSServer1
agent.pm.advancedOptions.config \-listeningPort 53
```

### SEE ALSO

[DNS Server Agent](#)

## DNS Server Resource Record

DNS Server Resource Record - add a resource record to the DNS server

### SYNOPSIS

```
set Traffic2_Network2 [::IxLoad new ixNetTraffic]
set Activity_DNSServer1 [$Traffic2_Network2 activityList.appendItem
$Activity_DNSServer1 agent.pm.zoneMgr.zoneChoices(0).resourceRecord
```

### DESCRIPTION

Each DNS server resource record list item represents a DNS domain that the server is authoritative over.

### SUBCOMMANDS

None.

### OPTIONS

id

Specifies the type of resource record defined. The remaining options in this command are dependent on this setting. One of:

option	Usage
A	Address record.
AAAA	IPV6 Address record
MX	Mail eXchanger record.
CNAME	Canonical Name record.
PTR	Pointer, or reverse DNS record.
NS	Name Server record.

### Options for id = A

address

The IP address of a host. (Default = "").

hostName

The name of the host. (Default = "").

**Options for id = AAAA**

address

The IPV6 address of a host. (Default = "").

hostName

The name of the host. (Default = "").

**Options for id = MX**

mailServer

The name of the mail server. (Default = "").

name

The mail domain name. (Default = "").

priority

The priority associated with the mail server. (Default = "").

**Options for id = CNAME**

name

An alias of a host. (Default = "").

realName

The real name of the host, as it appears in an A record. (Default = "").

**Options for id = PTR**

hostName

The host name for the ipAddress. (Default = "").

ipAddress

The IP address for the reverse lookup. (Default = "").

**Options for id = NS**

nameServer

The IP address for the name server. (Default = "").

zoneName

The zone name being served. (Default = "").

**EXAMPLES**

```
$Activity_DNSServer1 agent.pm.zoneMgr.zoneChoices.appendItem \-id
```



```

"Zone" \-predefine                true \-serial
1234 \-expire                      8888 \-name
"localhost" \-masterServer        "ixia-dns-tester"$Activity_
DNSServer1 agent.pm.zoneMgr.zoneChoices(0).resourceRecordList.clear$Activity_
DNSServer1 agent.pm.zoneMgr.zoneChoices(0).resourceRecordList.appendItem \-id
"A" \-hostName                    "localhost" \-address
"127.0.0.1"$Activity_DNSServer1 agent.pm.zoneMgr.zoneChoices(0).re-
sourceRecordList.appendItem \-id          "A" \-hostName
"host1" \-address                  "198.18.0.1"$Activity_DNSServer1
agent.pm.zoneMgr.zoneChoices(0).resourceRecordList.appendItem \-id
"NS" \-nameServer                  "198.18.0.2" \-zoneName
"localhost"$Activity_DNSServer1 agent.pm.zoneMgr.zoneChoices.appendItem \-id
"Zone" \-predefine                true \-serial
1234 \-expire                      8888 \-name
"ixiacom.com" \-masterServer      "ixia-dns-tester"

```

**SEE ALSO**[DNS Server Agent](#)[DNS Server Zone Management](#)

## DNS Statistics

For DNS client statistics, see [DNS Client Statistics](#)

For DNS server statistics, see [DNS Server Statistics](#)

## DNS Client Statistics

The table below describes the DNS client statistics.

Statistic	Description
General Statistics	
DNS Total Queries Attempted	Total number of DNS queries attempted. This statistic is only incremented if the DNS test objective is Query Attempts / Second.
DNS Total Queries Attempted/s	Rate, per second, at which the client attempted DNS queries. This statistic is only incremented if the DNS test objective is Query Attempts / Second.
DNS Total Queries Sent	Total number of DNS queries sent by the client.
DNS Total Queries Sent/s	Rate, per second, at which the client sent DNS queries.
DNS Total Queries Successful	Total number of DNS queries for which a valid response was received.
DNS Total Queries Successful/s	Rate, per second, at which DNS queries succeeded.
DNS Total Queries Retried	Total number of DNS queries that had to be re-sent at least once.
DNS Total Queries Retried/s	Rate, per second, at which DNS queries were retried.
DNS Total Queries Failed	Total number of DNS queries that failed for all reasons.
DNS Total Queries Failed/s	Rate, per second, at which DNS queries failed.
DNS Total Queries Failed (Format Error)	Number of DNS queries that failed because the DNS server could not interpret the format of the query. <b>Note:</b> According to RFC 1034, the maximum host name length is 63 bytes. IxLoad does not enforce this limit, and allows you to create queries for host names larger than 63 bytes. If you configure the DNS client to send a query to a host name that is larger than 63 bytes, the DNS server responds with a Format Error.

DNS Total Queries Failed (Format Error)/s	Rate, per second, at which DNS queries failed due to format errors.
DNS Total Queries Failed (Server Failure)	<p>Number of DNS queries that failed due to an error on the DNS server.</p> <p><b>Note:</b> According to RFC 1034, the maximum host name length is 63 bytes. IxLoad does not enforce this limit, and allows you to create Resource Records that include host names larger than 63 bytes.</p> <p>If you configure the DNS client to send a query to server zone for a Resource Record that contains a host name that is larger than 63 bytes, the DNS server responds with a Server Failure.</p>
DNS Total Queries Failed (Server Failure)/s	Rate, per second, at which DNS queries failed due to server failures.
DNS Total Queries Failed (Name Error)	Number of DNS queries that failed because the DNS name does not exist.
DNS Total Queries Failed (Name Error)/s	Rate, per second, at which DNS queries failed due to name errors.
DNS Total Queries Failed (Not Implemented)	Number of DNS queries that failed because the name server does not support the DNS request.
DNS Total Queries Failed (Not Implemented)/s	Rate, per second, at which DNS queries failed because the server does not support the request
DNS Total Queries Failed (Refused)	Number of DNS queries that failed because the DNS server refused the request.
DNS Total Queries Failed (Refused)/s	Rate, per second, at which DNS queries failed because the server refused the request.
DNS Total Queries Failed (Other)	Number of DNS queries that failed for unknown reasons.
DNS Total Queries Failed (Other)/s	Rate, per second, at which DNS queries failed due to unknown reasons.
DNS Total Queries Failed (Timeout)	Number of DNS queries that failed because no response was received within the timeout period.

DNS Total Queries Failed (Timeout)/s	Rate, per second, at which DNS queries failed due to timeouts.
DNS Total Queries Failed (Aborted)	Number of aborted DNS queries.
DNS Total Queries Failed (Aborted)/s	Rate, per second, at which DNS queries were aborted.
DNS Average Response Latency	Average time elapsed between the time the client sent a DNS query and the time it received a response.
DNS Minimum Response Latency	Shortest time elapsed between the time the client sent a DNS query and the time it received a response.
DNS Maximum Response Latency	Longest time elapsed between the time the client sent a DNS query and the time it received a response.
DNS Response Latency in 0 to 1 ms	Number of responses received within 0 to 1 milliseconds after the query was sent, including those at 1 millisecond.
DNS Response Latency in 1 to 50 ms	Number of DNS query responses received within 1 to 50 milliseconds after the query was sent, including those at 50 milliseconds.
DNS Response Latency in 50 to 100 ms	Number of DNS query responses received within 50 to 100 milliseconds after the query was sent, including those at 100 milliseconds.
DNS Response Latency in 100 to 500 ms	Number of DNS query responses received within 100 to 500 milliseconds after the query was sent, including those at 500 milliseconds.
DNS Response Latency in 500 ms to 1 second	Number of DNS query responses received within 500 milliseconds to 1 second after the query was sent, including those at 1 second.
DNS Response Latency in 1 second to 3 seconds	Number of DNS query responses received within 1 to 3 seconds after the query was sent, including those at 3 seconds.
DNS Response Latency more than 3 seconds	Number of DNS query responses received more than 3 seconds after the query was sent.
A Record Statistics	

DNS (Type A) Queries Sent	Number of A record queries sent.
DNS (Type A) Queries Sent/s	Rate, per second, at which Type A queries were sent.
DNS (Type A) Queries Successful With Match	Number of A record queries for which the DNS client received the expected IP address.
DNS (Type A) Queries Successful With Match/s	Rate, per second, at which Type A queries matched successfully.
DNS (Type A) Queries Successful Without Match	Number of A record queries which were processed without error but whose responses did not contain the expected IP address.
DNS (Type AAAA) Queries Successful Without Match/s	Rate, per second, at which Type A queries succeeded but did not contain the expected IP address.
DNS (Type A) Queries Failed	Number of A record queries for which an invalid response was received, or no response was received.
DNS (Type A) Queries Failed/s	Rate, per second, at which Type A queries failed.
AAAA Record Statistics	
DNS (Type AAAA) Queries Sent	Number of AAAA record queries sent.
DNS (Type AAAA) Queries Sent/s	Rate, per second, at which AAAA record queries were sent.
DNS (Type AAAA) Queries Successful With Match	Number of AAAA record queries for which the DNS client received the expected IP address.
DNS (Type AAAA) Queries Successful With Match/s	Rate, per second, at which AAAA record queries matched.
DNS (Type AAAA) Queries Successful Without Match	Number of AAAA record queries which were processed without error but whose responses did not contain the expected IP address.

DNS (Type AAAA) Queries Successful Without Match/s	Rate, per second, at which AAAA record queries succeeded but did not contain the expected IP address.
DNS (Type AAAA) Queries Failed	Number of AAAA record queries for which an invalid response was received, or no response was received.
DNS (Type AAAA) Queries Failed/s	Rate, per second, at which AAAA record queries failed.
CNAME Record Statistics	
DNS (Type CNAME) Queries Sent	Number of canonical name record queries sent.
DNS (Type CNAME) Queries Sent/s	Rate, per second, at which CNAME record queries were sent.
DNS (Type CNAME) Queries Successful With Match	Number of canonical name record queries for which the DNS server returned the expected host name.
DNS (Type CNAME) Queries Successful With Match/s	Rate, per second, at which the CNAME record responses contained the expected IP address.
DNS (Type CNAME) Queries Successful Without Match	Number of canonical name record queries which were processed without error but whose responses did not contain the expected host name.
DNS (Type CNAME) Queries Successful Without Match/s	Rate, per second, at which the CNAME record responses succeeded but did not contain the expected IP address.
DNS (Type CNAME) Queries Failed	Number of canonical name record queries for which an invalid response was received, or no response was received.
DNS (Type CNAME) Queries Failed/s	Rate, per second, at which CNAME record queries failed.
MX Record Statistics	
DNS (Type MX) Queries Sent	Number of mail exchange record queries sent.
DNS (Type MX) Queries Sent/s	Rate, per second, at which MX record queries were sent.

DNS (Type MX) Queries Successful With Match	Number of mail exchange record queries for which the response contained the expected mail server host name.
DNS (Type MX) Queries Successful With Match/s	Rate, per second, at which the MX record responses contained the expected IP address.
DNS (Type MX) Queries Successful Without Match	Number of mail exchange record queries that were processed without error but for which the response did not contain the expected mail server host name.
DNS (Type MX) Queries Successful Without Match/s	Rate, per second, at which the MX record responses succeeded but did not contain the expected IP address.
DNS (Type MX) Queries Failed	Number of mail exchange record queries for which an invalid response was received, or no response was received.
DNS (Type MX) Queries Failed/s	Rate, per second, at which MX record queries failed.
PTR Record Statistics	
DNS (Type PTR) Queries Sent	Number of pointer record queries sent.
DNS (Type PTR) Queries Sent/s	Rate, per second, at which PTR record queries were sent.
DNS (Type PTR) Queries Successful With Match	Number of pointer record queries for which the DNS client received the expected canonical host name for the supplied IP address.
DNS (Type PTR) Queries Successful With Match/s	Rate, per second, at which the PTR record responses contained the expected IP address.
DNS (Type PTR) Queries Successful Without Match	Number of pointer record queries that were processed correctly but whose responses did not contain the expected canonical host name.
DNS (Type PTR) Queries Successful Without Match/s	Rate, per second, at which the PTR record responses succeeded but did not contain the expected IP address.



DNS (Type PTR) Queries Failed	Number of pointer record queries for which an invalid response was received, or no response was received.
DNS (Type PTR) Queries Failed/s	Rate, per second, at which PTR record queries failed.
NS Record Statistics	
DNS (Type NS) Queries Sent	Number of name server record queries sent.
DNS (Type NS) Queries Sent/s	Rate, per second, at which NS record queries were sent.
DNS (Type NS) Queries Successful With Match	Number of name server record queries for which the DNS server returned the name server expected for the supplied domain.
DNS (Type NS) Queries Successful With Match/s	Rate, per second, at which the NS record responses contained the expected IP address.
DNS (Type NS) Queries Successful Without Match	Number of name server record queries which the DNS server processed without error but whose responses did not contain the expected name server.
DNS (Type NS) Queries Successful Without Match/s	Rate, per second, at which the NS record responses succeeded but did not contain the expected IP address.
DNS (Type NS) Queries Failed	Number of name server record queries for which an invalid response was received, or no response was received.
DNS (Type NS) Queries Failed/s	Rate, per second, at which NS record queries failed.
SOA Record Statistics	
DNS (Type SOA) Queries Sent	Number of Start of Authority record queries sent.
DNS (Type SOA) Queries Sent/s	Rate, per second, at which SOA record queries were sent.
DNS (Type SOA) Queries Successful With Match	Number of Start of Authority record queries for which the DNS client received the expected DNS server for the supplied domain.

DNS (Type SOA) Queries Successful With Match/s	Rate, per second, at which the SOA record responses contained the expected IP address.
DNS (Type SOA) Queries Successful Without Match	Number of Start of Authority record queries which were processed without error but whose responses did not contain the name of the expected DNS server.
DNS (Type SOA) Queries Successful Without Match/s	Rate, per second, at which the SOA record responses succeeded but did not contain the expected IP address.
DNS (Type SOA) Queries Failed	Number of Start of Authority record queries for which an invalid response was received, or no response was received.
DNS (Type SOA) Queries Failed/s	Rate, per second, at which SOA record queries failed.
NAPTR (ENUM) Query Statistics	
DNS (Type NAPTR) Queries Sent	Number of Naming Authority Pointer (ENUM) record queries sent.
DNS (Type NAPTR) Queries Sent/s	Rate, per second, at which NAPTR record queries were sent.
DNS (Type NAPTR) Queries Successful With Match	Number of Naming Authority Pointer (ENUM) queries for which the response contained a string that matched the Expect field.
DNS (Type NAPTR) Queries Successful With Match/s	Rate, per second, at which the NAPTR record responses contained the expected IP address
DNS (Type NAPTR) Queries Successful Without Match	Number of Naming Authority Pointer (ENUM) queries which were processed without error but for which the response did not contain a string that matched the Expect field.
DNS (Type NAPTR) Queries Successful Without Match/s	Rate, per second, at which the NAPTR record responses succeeded but did not contain the expected IP address.
DNS (Type NAPTR) Queries Failed	Number of Naming Authority Pointer (ENUM) queries for which an invalid response was received, or no response was received.
DNS (Type NAPTR) Queries Failed/s	Rate, per second, at which NAPTR record queries failed.

Bytes Transmitted and Received Statistics	
DNS Total Bytes Transmitted	Total bytes transmitted for all DNS queries, including re-tried queries.
DNS Total Bytes Received	Total bytes received for all DNS responses.
Test Objective Statistics	
DNS Bytes	Combined total number of DNS bytes transmitted and received.
DNS Throughput	Combined rate that the client received and transmitted DNS bytes.
DNS Transactions	Total number of DNS transactions completed. A DNS transaction consists of one query and one response to it.
DNS Transaction Rate	Rate at which the client completed DNS transactions completed.
DNS Simulated Users	Number of simulated users generating DNS queries.
DNS Queries Attempt/Second	Rate at which the client attempted DNS queries.

## DNS Server Statistics

The table below describes the DNS server statistics.

Statistic	Description
General Statistics	
DNS Total Queries Received	Total number of DNS queries received by the server.
DNS Total Queries Responded Successfully	Total number of DNS queries for which the server returned a valid response.
DNS Total Queries Failed	Total number of DNS queries which the server could not process for any reason.
DNS Total Queries Failed (Format Error)	<p>Number of DNS queries which the server could not process because it could not parse the query format.</p> <p><b>Note:</b> According to RFC 1034, the maximum label length is 63 bytes. IxLoad does not enforce this limit, and allows you to create queries for labels larger than 63 bytes.</p> <p>If you configure the DNS client to send a query to a label that is larger than 63 bytes, the DNS server responds with a Format Error.</p>
DNS Total Queries Failed (Server Failure)	<p>Number of DNS queries that failed due to an error on the server.</p> <p><b>Note:</b> According to RFC 1034, the maximum label length is 63 bytes. IxLoad does not enforce this limit, and allows you to create Resource Records that include labels larger than 63 bytes.</p> <p>If you configure the DNS client to send a query to server zone for a Resource Record that contains a label that is larger than 63 bytes, the DNS server responds with a Server Failure.</p>
DNS Total Queries Failed (Name Error)	Number of DNS queries that failed because the DNS name does not exist.
DNS Total Queries Failed (Not Implemented)	Number of DNS queries that failed because the name server does not support the DNS request.
DNS Total Queries Failed (Refused)	Number of DNS queries that failed because the server refused to serve the query.
DNS Total Queries Failed (Other)	Number of DNS queries that failed for unknown reasons.

A Record Statistics	
DNS (Type A) Queries Received	Number of A record queries received.
DNS (Type A) Queries Responded Successfully	Number of A record queries for which the DNS server returned a valid response.
DNS (Type A) Queries Failed	Number of A record queries that failed for any reason.
AAAA Record Statistics	
DNS (Type AAAA) Queries Received	Number of AAAA record queries received.
DNS (Type AAAA) Queries Responded Successfully	Number of AAAA record queries for which the DNS server returned a valid response.
DNS (Type AAAA) Queries Failed	Number of AAAA record queries that failed for any reason.
CNAME Record Statistics	
DNS (Type CNAME) Queries Received	Number of canonical name record queries received.
DNS (Type CNAME) Queries Responded Successfully	Number of canonical name record queries for which the DNS server returned a valid response.
DNS (Type CNAME) Queries Failed	Number of canonical name record queries that failed for any reason.
MX Record Statistics	
DNS (Type MX) Queries Received	Number of mail exchange record queries received.
DNS (Type MX) Queries Responded Successfully	Number of mail exchange record queries for which the DNS server returned a valid response.
DNS (Type MX) Queries Failed	Number of mail exchange record queries that failed for any reason.

PTR Record Statistics	
DNS (Type PTR) Queries Received	Number of pointer record queries received.
DNS (Type PTR) Queries Responded Successfully	Number of pointer record queries for which the DNS server returned a valid response.
DNS (Type PTR) Queries Failed	Number of pointer record queries that failed for any reason.
NS Record Statistics	
DNS (Type NS) Queries Received	Number of name server record queries received.
DNS (Type NS) Queries Responded Successfully	Number of name server record queries for which the DNS server returned a valid response.
DNS (Type NS) Queries Failed	Number of name server record queries that failed for any reason.
SOA Record Statistics	
DNS (Type SOA) Queries Received	Number of Start of Authority record queries received.
DNS (Type SOA) Queries Responded Successfully	Number of Start of Authority record queries for which the DNS server returned a valid response.
DNS (Type SOA) Queries Failed	Number of Start of Authority record queries that failed for any reason.
Bytes Transmitted and Received Statistics	
DNS Total Bytes Transmitted	Total bytes transmitted for all DNS queries, including re-tried queries.
DNS Total Bytes Received	Total bytes received for all DNS responses.
DNS Total Bytes Transmitted and Received	Combined total of bytes received in DNS queries and transmitted in DNS responses.

! 15

This page intentionally left blank.



# FTP

This section describes the FTP Tcl API objects.

## Overview

FTP protocol commands are organized as follows.

```
FTP Client Agent
FTP Client Action
FTP Server Agent
```

## Objectives

The objectives (userObjective) you can set for FTP are listed below. Test objecare set in the ixTimeline object.

- connectionRate
- transactionRate
- simulatedUsers
- concurrentConnections
- throughputMbps
- throughputKbps
- throughputGbps

## FTP Client Agent

The FTP Client Agent defines a simulated user performing FTP requests against one or more FTP servers. Refer to FTP Client Agent for a full description of this command. The important options of this command are listed in the table below:

Option	Usage
enable	Enables the use of the FTP client agent.
name	The name associated with the client agent.
actionList	The list of actions associated with the agent.
realFileList	Add real files in client and server plugins.
mode	The active/passive mode of the FTP interaction.
userName	The default user name for actions.
password	The default password for actions.

## FTP Client Action

Each client action is a single step in the interaction. Refer to `FTP Client Action` for a full description of this command. The important subcommands and options of this command are listed below.

Subcommand	Usage
checkConfig	Checks the configuration of the action.

Option	Usage
command arguments	The FTP command, with optional arguments, to be executed.
destination	The name/address of the FTP server.
userName	The user name to use for login commands.
password	The password to use for login commands.

## FTP Server Agent

The FTP Server Agent defines the operation of the FTP server. Refer to `FTP Server Agent` for a full description of this command. The important options of this command are listed in the table below:

Option	Usage
enable	Enables the use of the FTP server agent.
name	The name associated with the server agent.
ftpPort	The port number that the server will respond on.
realFileList	Add real files in client and server plugins.

## realFileList

To add real files, use the `realFileList` is exposed in both client and server plugins. It is a sequence container of **RealFileObjects**. RealFileObjects have two configurables exposed, `page` and `payload`.

Option	Usage
<code>page</code>	Any linux file name ( <code>client_file1</code> )
<code>payload</code>	The actual path of the file. ("C:\\Program Files\\Ixi-a\\IxLoad\\buildversion.ini")

For a sample script refer to the example section of FTP Client Agent .

## FTP Client Agent

FTP Client Agent - create an FTP client

### SYNOPSIS

```
set Traffic1_Network1 [::IxLoad new ixNetTraffic]
set Activity_FTPClient1 [$Traffic1_Network1 activityList.appendItem options...]
Activity_FTPClient1 agent.config options...
```

### DESCRIPTION

An FTP client agent is added to the `activityList` object. The `activityList` object is added to the `ixNetTraffic` object using the `appendItem` subcommand from the `ixConfigSequenceContainer` command.

Each member of the list, however may be separately addressed and modified using the `ixConfig` subcommands.

### SUBCOMMANDS

None.

### OPTIONS

`actionList`

A list of actions that the agent should perform, of type `FTP Client Action`.

`enable`

Enables the use of this agent. (Default = true).

`enableEsm`

If `true`, the use of the `esm` option is enabled. (Default = false).

`enableTos`

Enables the setting of the TOS (Type of Service) bits in the header of the FTP packets. Use the `tos` option to specify the TOS bit setting.

0	(default) TOS bits not enabled.
1	TOS bits enabled.

`esm`

If `enableEsm` is `true`, this option specifies the TCP Maximum Segment Size in the `MSS (RX)` field. Otherwise, the TCP Maximum Segment Size as 1,460 bytes. (Default = 1,460).

`enableVlanPriority`

VLAN Priority can be set on a per-activity basis or on a per-network (NetTraffic) basis. This parameter sets the VLAN priority for the activity. An activity's VLAN Priority bit setting takes precedence over a network's Priority bit setting. If `true`, IxLoad sets the VLAN Priority bit in traffic from this activity. Configure the VLAN priority value in `vlanPriority`. (Default = `false`).

`fileList`

Represents a list of filenames which is of the form `#<a number>`. These can be referred in the `arguments` option in any of the `ixFtpAction` Objects.

`vlanPriority`

When `enableVlanPriority` is `true`, this option accepts the vlan priority value.

`ipPreference`

If a mixture of IPv4 and IPv6 addresses are available on the client network, this parameter configures which address types the agent uses.

0	IPv4
1	IPv6
2	(default) Both, IPv4 first
3	Both, IPv6 first

`loopValue`

If this option is enabled (1), then the client progresses through the command list repeatedly until the test's sustain time. If the option is disabled (0), then the client will progress through the command list only once, and then go idle. (Default = 0).

`mode`

The mode that the client will use to access the server: To establish an FTP connection, the client connects from a random unprivileged port (port `n`, where `n` is greater than 1,024) to the FTP server's command port, normally port 21. What happens next depends on whether the client is in active or passive mode. The choices are listed below:

Option	Usage
"ACTIVE"	(Default) . The client sends the PORT command and waits for an OK response from the server.
"PASSIVE"	In Passive mode, the client initiates both connections to the server.

`name`

The name associated with this object, which must be set at object creation.

`password`

Enter the password for the default user name in `userName`. When you use a LOGIN action in the action list, this password will be used by default. (Default = "noreply@ixiacom.com").

You can insert sequence generators into this field to create unique entries automatically. For information on how to use sequence generators, see <X-ref>"Using Automatic Sequence Generators" on page -1.

`tos`

If `enableTos` is `true`, this option specifies the IP Precedence / TOS (Type of Service bit setting and Assured Forwarding classes). (Default="Best Effort 0x0"). If you want to specify the standard choices that are in the GUI, you can use a string representation. To specify any of the other 255 TOS values, specify the decimal value. The choices are:

"Best Effort (0x0)"	(Default) routine priority
"Class 1 (0x20)"	Priority service, Assured Forwarding class 1
"Class 2 (0x40)"	Immediate service, Assured Forwarding class 2
"Class 3 (0x60)"	Flash, Assured Forwarding class 3
"Class 4 (0x80)"	Flash-override, Assured Forwarding class 4
"Express Forwarding (0xA0)"	Critical-ecp
"Control (0xC0)"	Internet-control

`userName`

Enter the default user name that the client will use to login to the FTP server. When you use a LOGIN action in the action list, this user name will be used by default. Ixia servers currently only accept a user name of 'root.' (Default = "root").

## STATISTICS

### EXAMPLE

```
set Traffic1_Network1 [::IxLoad new ixNetTraffic]

#-----# Activity FTPClient1
of NetTraffic Traffic1@Network1#-----
-----set Activity_FTPClient1 [$Traffic1_Network1 activityList.appendItem \-
protocolAndType                "FTP Client" ]

#----- # Timeline1 for activ-
ities FTPClient1#-----set
Timeline1 [::IxLoad new ixTimeline]$Timeline1 config \-rampUpValue
```



```

1 \-rampUpType          0 \-offlineTime
0 \-rampDownTime       20 \-standbyTime
0 \-iterations         1 \-rampUpInterval
1 \-sustainTime        20 \-timelineType
0 \-name               "Timeline1"

$Activity_FTPClient1 config \-enable true \-name
"FTPClient1" \-enableConstraint false \-userObjectiveValue
100 \-constraintValue 100 \-userObjectiveType
"simulatedUsers" \-timeline $Timeline1

$Activity_FTPClient1 agent.config \-userName "root"
\-enableTos false \-loopValue
true \-enable true \-ipPreference
2 \-name "FTPClient1" \-vlanPriority
0 \-tos 0 \-fileList
"'/#1', '/#4', '/#16', '/#64', '/#256', '/#1024', '/#4096', '/#16384', '/#65536',
'/#262144', '/#1048576'" \-enableEsm false \-mode
"ACTIVE" \-esm 1460 \-password
"noreply@ixiacom.com" \-enableVlanPriority false $Activity_
FTPClient1 agent.actionList.clearset my_ixFtpAction [::IxLoad new ixFtpAction]$my_
ixFtpAction config \-userName "root" \-destination
"Traffic2_FTPServer1:21" \-sessionId "1" \-command
"{Get}" \-arguments "/#4096" \-password
"noreply@ixiacom.com"$Activity_FTPClient1 agent.actionList.appendItem -object $my_
ixFtpAction

```

**SEE ALSO**[FTP Client Action](#)[ixNetTraffic](#)

## FTP Client Action

FTP Client Action - define the commands that the FTP client will execute

### SYNOPSIS

```
set clientTraffic [::IxLoad new ixClientTraffic options]
$clientTraffic agentList.appendItem options...
$clientTraffic agentList(0).actionList.appendItem options...

set Traffic1_Network1 [::IxLoad new ixNetTraffic]
set Activity_FTPClient1 [$Traffic1_Network1 activityList.appendItem
$Activity_FTPClient1 agent.actionList.appendItem -object $my_ixFtpAction
```

### DESCRIPTION

An FTP client action is added to the `actionList` option of the FTP Client Agent `activityList` object using its `appendItem`. See the following example:

Each member of the list, however may be separately addressed and modified using the `ixConfig` subcommands.

### SUBCOMMANDS

The options for this command are configured and read using the standard `config`, `cget`, and `getOption` subcommands defined in the `ixConfig` command. In addition the following commands are available. Unless otherwise described, no values are returned and an exception is raised for any error found.

#### checkConfig

This subcommand checks the configuration of an individual action.

### OPTIONS

arguments

This option contains an argument that is used by the various commands defined in the `command` option. The type of the value depends on the command:

Command option	Usage
"CD"	The path to switch to.
"{Get}"	The path to where the file is stored.
"LOGIN"	N/A.

"{Put}"	The path/size of the file to be sent to the server.
"QUIT"	N/A.
"RETRIEVE"	The path to where the file is stored.
"STORE"	The path/size of the file to be sent to the server.
"{Think}"	The number of milliseconds to pause before executing the next command in the action list.

command

Selects the FTP command to be used. One of:

Option	Usage
"CD"	Changes the current working directory to the value in the <code>arguments</code> option.
"{Get}"	(Default). Retrieves the file specified in the <code>argument</code> option. {Get} is not a standard FTP command; it allows you to retrieve a file from an Ixia server without having to log in.
"LOGIN"	Logs in to the FTP server using the name and password in the <code>us</code> and <code>password</code> options.
"{Put}"	Copies the file specified in the <code>arguments</code> option from the client to the server. {Put} is not a standard FTP command; it allows you to store a file on an Ixia server without having to log in.
"QUIT"	Logs out of the FTP server.
"RETRIEVE"	Retrieves the file specified in the <code>arguments</code> option.
"STORE"	Copies the file specified in the <code>arguments</code> option from the client to the server.
"{Think}"	Adds a pause (think time) before the next command is executed. Specify the duration of the pause in the <code>arguments</code> option.
"{LoopBegin}"	An IxLoad command that you can add to the Command List to cause the commands between it and the {Loop End} to be executed a specified number of times.
"{LoopEnd}"	Ends the list of commands that will be executed by the preceding {Loop Begin} command.

destination

Either the IP address of a real FTP server or the value of the `-name` option of an FTP Server Agent. If the FTP server listens on a port other than the standard (21), enter a colon after the IP address and then

enter the port number. When using an FTP Server Agent, the port number must agree with that defined by the Server Agent. See the following example:

```
192.168.0.1:21
```

The `destination` option also accepts IPv6 addresses. IxLoad supports all forms of IPv6 addressing except `::dotted-quad` notation (for example, `:::1.2.3.4`).

```
password
```

The password for the user name. Ixia servers accept any password.

```
userName
```

The user name that the client will use to log in to the FTP server. Ixia servers only accept a user name of `root`.

### EXAMPLE

```
set my_ixFtpAction [::IxLoad new ixFtpAction]$my_ixFtpAction config \-userName
"root" \-destination "Traffic2_FTPServer1:21" \-
sessionId "1" \-command
"{Get}" \-arguments "/#4096" \-password
"noreply@ixiacom.com"$Activity_FTIClient1 agent.actionList.appendItem -object $my_
ixFtpAction
```

### SEE ALSO

[FTP Client Agent](#)

## FTP Server Agent

FTP Server Agent - configure an FTP server

### SYNOPSIS

```
set Traffic2_Network2 [::IxLoad new ixNetTraffic]
set Activity_FTPServer1 [$Traffic2_Network2 activityList.appendItem
$Activity_FTPServer1 agent.config options...
```

### DESCRIPTION

An FTP server agent is added to the `activityList` object. The `activityList` object is added to the `ixNetTraffic` object using the `appendItem` subcommand from the `ixConfigSequenceContainer` command.

Each member of the list, however may be separately addressed and modified using the `ixConfig` subcommands.

### SUBCOMMANDS

The options for this command are configured and read using the standard `config`, `cget`, and `getOptions` subcommands defined in the `ixConfig` command.

### OPTIONS

`enable`

Enables the use of this server agent. (Default = true).

`enableEsm`

If true, the use of the `esm` option is enabled. (Default = false).

`enableTos`

Enables the setting of the TOS (Type of Service) bits in the header of the FTP packets. Use the `tos` option to specify the TOS bit setting.

0	(default) TOS bits not enabled.
1	TOS bits enabled.

`esm`

If `enableEsm` is true, this option specifies the TCP Maximum Segment Size in the MSS (RX) field. Otherwise, the TCP Maximum Segment Size is 1,460 bytes. (Default = 1,460).

`enableVlanPriority`

VLAN Priority can be set on a per-activity basis or on a per-network (NetTraffic) basis. This parameter sets the VLAN priority for the activity. An activity's VLAN Priority bit setting takes precedence over a network's Priority bit setting. If `true`, IxLoad sets the VLAN Priority bit in traffic from this activity. Configure the VLAN priority value in `vlanPriority`. (Default = `false`).

`vlanPriority`

When `enableVlanPriority` is `true`, this option accepts the `vlan` priority value.

`ftpPort`

The port number that the FTP server listens on. To specify multiple listening ports, enter the port numbers, separated by commas (,). You can specify up to 50 listening ports. (Default = 21).

`name`

The name associated with this object, which must be set at object creation.

`tos`

If `enableTos` is `true`, this option specifies the IP Precedence / TOS (Type of Service bit setting and Assured Forwarding classes. (Default="Best Effort 0x0"). If you want to specify the standard choices that are in the GUI, you can use a string representation. To specify any of the other 255 TOS values, specify the decimal value. The default choices are:

"Best Effort (0x0)"	(Default) routine priority
"Class 1 (0x20)"	Priority service, Assured Forwarding class 1
"Class 2 (0x40)"	Immediate service, Assured Forwarding class 2
"Class 3 (0x60)"	Flash, Assured Forwarding class 3
"Class 4 (0x80)"	Flash-override, Assured Forwarding class 4
"Express Forwarding (0xA0)"	Critical-ecp
"Control (0xC0)"	Internet-control

## STATISTICS

### EXAMPLE

```
set Traffic2_Network2 [::IxLoad new ixNetTraffic]
```

```
#-----# Activity FTPServer1
```

```

of NetTraffic Traffic2@Network2#-----
-----set Activity_FTPServer1 [$Traffic2_Network2 activityList.appendItem \-
protocolAndType "FTP Server" ]set _Match_Longest_ [::IxLoad
new ixMatchLongestTimeline]$Activity_FTPServer1 config \-enable
1 \-name "FTPServer1" \-timeline
$_Match_Longest_$Activity_FTPServer1 agent.config \-enableTos
0 \-enable 1 \-name
"FTPServer1" \-vlanPriority 0 \-tos
0 \-ftpPort 21 \-enableEsm
0 \-esm 1460 \-enableVlanPriority
0$Activity_FTPServer1 agent.realFileList.clearset my_RealFileObject11 [::IxLoad new
RealFileObject]$my_RealFileObject11 config \-payloadFile
"<Dummy File>" \-page "/#1"$Activity_FTPServer1
agent.realFileList.appendItem -object $my_RealFileObject11

```

**SEE ALSO**

ixServerTraffic

## **FTP Statistics**

For the FTP statistics, see the following:

[FTP Client Statistics](#)

[FTP Server Statistics](#)



## FTP Client Statistics

The table below lists the statistics that IxLoad reports for FTP clients. Statistics in the results files and reports are averaged over all ports. If a statistic for an interval is missing, IxLoad interpolates it from the statistic immediately prior to it and the statistic after it.

The test results are available from the location defined on the User Directories window. See User Directories.

The QoE Detective column indicates the QoE Detective views in which a statistic is available:

**IP:** per-IP view

**User:** per-User view

**VLAN:** per-VLAN view

**All:** all views

For TCP statistics, see TCP, Run State, and Curve Segment Statistics.

Statistic	QoE Detective	Description
FTP Bytes	- -	Total number of FTP bytes sent.
FTP Control Bytes Received	All	Number of bytes received on the control connections by the FTP client.
FTP Control Bytes Sent	All	Number of bytes transmitted on the control connections by the FTP client.
FTP Control Conn Requested	All	Number of requests to establish control connections sent by the clients.
FTP Control Conn Established	All	Number of control connections established by the clients.
FTP Control Conn Failed	All	Number of control connections that could not be established.
FTP Control Conn Failed (Rejected)	All	Number of control connections that could not be established because the server rejected the connection request.
FTP Control Conn Failed (Other)	All	Number of control connections that could not be established for reasons other than rejection by the server.
FTP Control Conn Active	All	Number of control connections actively transferring FTP commands.

FTP Data Conn Established	All	Number of data connections established.
FTP Data Conn Established (Active Mode)	All	Number of data connections established in Active mode.
FTP Data Conn Requested (Passive Mode)	All	Number of data connections requested in Passive mode.
FTP Data Conn Established (Passive Mode)	All	Number of data connections established in passive mode.
FTP Data Conn Failed (Passive Mode)	All	Number of data connections that failed.
FTP Data Conn Active	All	Number of data connections active.
FTP File Uploads Requested	All	Number of requests to upload files sent by the clients.
FTP File Uploads Successful	All	Number of uploads that completed successfully.
FTP File Uploads Failed	All	Number of upload attempts that failed.
FTP File Downloads Requested	All	Number of requests to download files sent by the clients.
FTP File Downloads Successful	All	Number of downloads that completed successfully.
FTP File Downloads Failed	All	Number of download attempts that failed.
FTP Data Bytes Sent	All	Number of bytes transmitted on the data connections by the FTP client
FTP Data Bytes Received	All	Number of bytes received on the data connections by the FTP client.
FTP Control Bytes Sent	All	Number of bytes received on the control connections by the FTP client.
FTP Control Bytes Received	All	Number of bytes received on the control connections by the FTP client.
FTP Simulated Users	- -	Number of users to be simulated during the test.

FTP Connections	--	Number of FTP connections between clients and servers, including both control and data connections.
FTP Transactions	--	Number of transactions completed by the clients.
FTP Bytes	All	Total number of FTP bytes sent.
FTP Throughput	--	Rate, in bytes per second, at which the client sent and received FTP data.
FTP Throughput (Kbps)	All	Rate, in kilobits per second, at which the client sent and received FTP data. This statistic is only available in Conditional View.
FTP Connection Rate	All	Rate at which the client established FTP connections.
FTP Transaction Rate	All	Average rate at which the clients completed FTP transactions.
FTP Concurrent Sessions	All	Number of simultaneous FTP sessions active.
FTP Control Connection Latency (ms)	All	Average amount of latency on control connections, in milliseconds. Note for Tcl API users: This is a weighted statistic. If you are using this statistic in a Tcl script, use the <i>kWeightedAverage</i> aggregation type.
FTP Data Connection Latency (Passive Mode) (ms)	All	Average amount of latency (in milliseconds) on data connections that were established in Passive mode. Note for Tcl API users: This is a weighted statistic. If you are using this statistic in a Tcl script, use the <i>kWeightedAverage</i> aggregation type.

## FTP Server Statistics

The table below lists the statistics that IxLoad reports for FTP servers. Statistics in the results files and reports are averaged over all ports. If a statistic for an interval is missing, IxLoad interpolates it from the statistic immediately prior to it and the statistic after it.

The QoE Detective column indicates which views a statistic is available in:

**IP:** per-IP view

**User:** per-User view

**VLAN:** per-VLAN view

**All:** all views

The test results are available from the location defined on the User Directories window. See User Directories.

For TCP statistics, see TCP, Run State, and Curve Segment Statistics.

Statistic	Conditional Views	Description
FTP Control Conn Received	IP, VLAN	Number of requests to establish control connections received by the servers.
FTP Control Conn Established	IP, VLAN	Number of control connections established by the servers.
FTP Control Conn Rejected	IP, VLAN	Number of requests to establish control connections rejected by the servers.
FTP Control Conn Active	IP, VLAN	Number of control connections actively transferring FTP commands.
FTP Data Conn Established	IP, VLAN	Number of data connections established by the server (active and passive mode).
FTP Data Conn Requested (Active Mode)	IP, VLAN	Number of requests to establish data connections in active mode received by the servers.
FTP Data Conn Established (Active Mode)	IP, VLAN	Number of data connections established in active mode.
FTP Data Conn Failed (Active Mode)	IP, VLAN	Number of data connections opened in active mode that failed.
FTP Data Conn Established (Passive Mode)	IP, VLAN	Number of data connections established in passive mode.

FTP Data Conn Active	IP, VLAN	Number of data connections actively uploading or downloading data.
FTP File Uploads Requested	IP, VLAN	Number of requests to upload data received by the servers.
FTP File Uploads Successful	IP, VLAN	Number of uploads that completed successfully.
FTP File Uploads Failed	IP, VLAN	Number of uploads that failed.
FTP File Downloads Requested	IP, VLAN	Number of requests to download files received by the servers.
FTP File Downloads Successful	IP, VLAN	Number of downloads that completed successfully.
FTP File Downloads Failed	IP, VLAN	Number of downloads that failed.
FTP Data Bytes Sent	- -	Number of bytes sent by the servers on data connections.
FTP Data Bytes Received	- -	Number of bytes received by the servers on data connections.
FTP Control Bytes Sent	- -	Number of bytes sent by the servers on control connections.
FTP Control Bytes Received	- -	Number of bytes received by the servers on control connections.
FTP Data Connection Latency (Active Mode) (ms)	IP, VLAN	Average amount of latency (in milliseconds) on data connections opened in active mode. Note for Tcl API users: This is a weighted statistic. If you are using this statistic in a Tcl script, use the <i>kWeightedAverage</i> aggregation type.

This page intentionally left blank.

# HTTP

This section describes the HTTP Tcl API objects.

## Overview

HTTP protocol commands are organized as:

- HTTP Client Agent
- HTTP Client Action
- HTTP Server Agent
- ixCookieContents
- ixResponseHeader
- ixWebPageObject
- CustomPayloadObject

Additional topics included are:

- Supported Ciphers— describes the set of supported encryption ciphers.
- Using Your Own Web Pages In IxLoad describes how to use your own Web pages in the server's emulation.
- Using Sequence Generators in HTTP Client Commands and Server Header Name=Value Fields— describes how to use variables to generate large numbers of difobjects.

## Objectives

The objectives (userObjective) you can set for HTTP are listed below. Test objectives are set in the ixTimeline object.

- connectionRate
- connectionAttemptRate
- transactionRate
- simulatedUsers
- concurrentConnections
- throughputMbps
- throughputKbps

- throughputGbps



## HTTP Client Agent

HTTP Client Agent

### SYNOPSIS

```
set HTTP_client_client_network [::IxLoad new ixNetTraffic]
set Activity_newAgent1 [$HTTP_client_client_network activityList.appendItem
option...]
$Activity_newAgent1 agent.config \
```

### DESCRIPTION

An HTTP client agent is added to the `activityList` object. The `activityList` object is added to the `ixNetTraffic` object using the `appendItem` subcommand from the `ixConfigSequenceContainer` command.

Two subcommands are available to load certificates and private keys: `importCertificate` and `importPrivateKey`.

### SUBCOMMANDS

The options for this command are configured and read using the standard `config`, `cget`, and `getOptions` subcommands defined in the `ixConfig` command. In addition, the following commands are available. Unless otherwise described, no values are returned and an exception is raised for any error found.

```
importCertificate file
```

Imports a certificate from a disk `file`, setting the `certificate` option with the result. `True` is returned if the import succeeded and `false` otherwise. `IxLoad` can import ASCII PEM (Privacy Enhanced Mail) or binary (PKCS#12) certificates and keys; it converts binary certificates and keys into ASCII PEM format.

- PEM uses Base64 encoding, and is optimized for sending binary data in 7-bit transport environments like the Internet.
- PKCS #12 (Public Key Cryptography Standard #12) is an industry standard format used to transfer certificates and their corresponding private keys from one computer to another, or from a computer to removable media. If this format is imported, the `privateKeyPassword` must be set.



**Note:** Even though the certificate and key are stored in the same file, you must import each one separately.

**Example**  

```
$Activity_newClientActivity1 agent.importCertificate "C:/ProgramFiles/Ixia/IxLoad/3.40.49.32-EB/Client/Plugins/agent/HTTP_Common/SSL_Certificates/Unsecured_RSA_cert_512.pem"
```

```
importPrivateKey file
```

This subcommand performs the same function, but for the private key. The decoded and decrypted values are set into the `password` option and `true` or `false` are returned to indicate success and failure, respectively.

```
$Activity_newClientActivity1 agent.importPrivateKey "C:/ProgramFiles/Ixi-
a/IxLoad/3.40.49.32-EB/Client/Plugins/agent/HTTP_Common/SSL_Certificates/Unsecured_
RSA_key_512.pem"
```

**OPTIONS**

`actionList`

A list of actions that the agent should perform, of type `HTTP Client Action`. Actions are normally added using the `appendItem` subcommand.

`browserEmulation`

The type of browser that the client will emulate. One of:

Option	Usage
::HTTP_Client(kBrowser-TypeNone) or "<Custom>"	No browser is emulated by the client. The headers may be entered in the <code>headerList</code> option.
::HTTP_Client(kBrowser-TypeIE5) "Microsoft IE 5.x"	Microsoft Internet Explorer 5.x browser is emulated by the client.
::HTTP_Client(kBrowser-TypeMozilla) "Mozilla"	Netscape, Mozilla, and Firefox browsers are emulated by the client.
::HTTP_Client(kBrowser-TypeIE6) "Microsoft IE 6.x"	(Default) Microsoft Internet Explorer 6.x browser is emulated by the client.
::HTTP_Client(kBrowser-TypeFirefox) "Firefox"	The Firefox browser is emulated by the client.
::HTTP_Client(kBrowser-TypeSafari) "Safari"	The Safari browser is emulated by the client.

`certificate`

---

If `enableSsl` is `true`, this is a certificate to be used by the client if requested by the server. The certificate must be an X.509 certificate in binary format, fully decoded. The `importCertificate` sub-command can read and decode a certificate held in a disk file. (Default = "").

`clientCiphers`

If `enableSsl` is `true`, this is a ':' separated list of encryption ciphers that will be supported by the client. See Supported Ciphers for a list of supported ciphers. (Default = "DEFAULT").

`cookieJarSize`

If `enableCookieSupport` is `true`, this option indicates the number of cookies that will be saved for each client. The maximum value of this is 300. (Default = 10).

`cookieRejectProbability`

If `enableCookieSupport` is `true`, then this option indicates the probability, from 0 to 1, that a client will reject a request for a cookie's contents from the server. (Default = 0.0).

`enable`

Enables the use of this action. (Default = true).

`enableCookieSupport`

If `true`, then the client will support cookie retention, as indicated in the `cookieJarSize` and `cookieRejectProbability`. (Default = false).

`piggybackAck`

If `true`, the client includes the ACK for the previous packet in the same packet as the next packet.. (Default = true).

`enableDecompressSupport`

If `true`, the client decodes pages that have been encoded using a supported encoding method such as `gzip` or `deflate`. (Default = false).

`enableEsm`

If `true`, the use of the `esm` option is enabled. (Default = false).

`enableHttpProxy`

If `true`, the client will retrieve pages from an HTTP proxy device defined in `httpProxy` instead of the target specified in the URL. (Default = false).

`enableHttpsProxy`

If `true`, the client will retrieve secure (SSL) pages from an HTTPS proxy device defined in `httpsProxy` instead of the target specified in the URL. (Default = false).

`enableHttpsTunnel`

If `true`, the client will retrieve secure (SSL) pages from over an HTTPS tunnel defined in `httpsTunnelIp` instead of the target specified in the URL. (Default = `false`).

`enableIntegrityCheckSupport`

If `true`, the client calculates a checksum for a received page and compares it with the checksum received from the server. (Default = `false`).

`enableLargeHeader`

If enabled, this specifies whether IxLoad will support large headers. It accepts boolean value of `True` or `False`. (Default = `false`).

`enablePerConnCookieSupport`

If enabled, cookies are maintained on a per-connection basis instead of on a per-user basis. (Default = `false`).

`enableSsl`

If `true`, then the client will support SSL interactions. The operation of SSL mode is controlled by the `certificate`, `clientCiphers`, `privateKey`, `privateKeyPassword`, `sequentialSessionReuse (sic)`, and `sslVersion` options. (Default = `0`).

`enableTos`

Enables the setting of the TOS (Type of Service) bits in the header of the HTTP packets. Use the `tos` option to specify the TOS bit setting.

0	(default) TOS bits not enabled.
1	TOS bits enabled.

`esm`

If `enableEsm` is `true`, this option specifies the TCP Maximum Segment Size in the MSS (RX) field. Otherwise, the TCP Maximum Segment Size is 1,460 bytes. (Default = `1,460`).

`enableVlanPriority`

VLAN Priority can be set on a per-activity basis or on a per-network (NetTraffic) basis. This parameter sets the VLAN priority for the activity. An activity's VLAN Priority bit setting takes precedence over a network's Priority bit setting. If `true`, IxLoad sets the VLAN Priority bit in traffic from this activity. Configure the VLAN priority value in `vlanPriority`. (Default = `false`).

`vlanPriority`

When `enableVlanPriority` is `true`, this option accepts the `vlan` priority value.

`followHttpRedirects`

If `true`, the client follows HTTP Redirect commands from the server. An HTTP Redirect is a response status code from the server in the range 300-399 that defines the reason for redirection (for example,

“301 Moved Permanently”) and supplies an alternative location (specified in the Location HTTP header) from which the client can retrieve the page. (Default = false).

headerList

If `browserEmulation` is set to “None,” then this list of headers will be transmitted as part of a client request. This list is of type `ixResponseHeader`; items are added to the list via the `appendItem` sub-command. Each element of the list must be of the form “key: value” without any spaces in the key. (Default = None).

httpProxy

If `enableHttpProxy` is true, this option is the name of a HTTP proxy device (typically, a caching device) that will be used instead of the target specified in the URL. It should be of the form: <IP address>:<port>; for example, 192.168.3.1:8080. (Default = “”).

httpsProxy

If `enableHttpsProxy` is true, this option is the name of a HTTPS proxy device (typically, a caching device) that will be used instead of the target specified in the URL for secure (SSL) pages. It should be of the form: <IP address>:<port>; for example, 192.168.3.1:8080. (Default = “”).

httpsTunnelIp

If `enableHttpsTunnel` is true, this is the IP address of the HTTPS tunnel that will be used instead of the target specified in the URL for secure (SSL) pages. It should be of the form: <IP address>:<port>; for example, 192.168.3.1:8080. (Default = “”).

httpVersion

Select the version of the HTTP protocol that you want to use in the test. One of:

Option	Usage
“1.0”	(Default) Under HTTP 1.0 without Keep-Alive, when a user clicks on a link for a Web page, a TCP connection request is sent by the client to the server. When the server accepts the connection, the client sends an HTTP GET request to download the Web page from the server. The client acknowledges receipt of the page by sending an ACK to the server. After making a single HTTP request, the client closes the TCP connection. After the server has sent the entire page, it will also close the connection from its side. See the description of <code>keepAlive</code> for a description of its effect on HTTP 1.0
“1.1”	Most browsers use HTTP 1.1. If a client and server use HTTP 1.1, multiple HTTP requests can be sent by the client on a single TCP connection. This saves processing power, since fewer TCP connections need to be established. HTTP 1.1 also allows for persistent connections, enabling connections to stay up for (relatively) long periods of time. In HTTP 1.1, the server initiates the closing of the TCP connection by sending a FIN message.

ipPreference

If a mixture of IPv4 and IPv6 addresses are available on the client network, this parameter configures which address types the agent uses.

0	IPv4
1	IPv6
2	(default) Both, IPv4 first
3	Both, IPv6 first

`keepAlive`

This option is only applicable if `httpVersion` is set to "1.0."

If this option is set to true, the client adds the Connection: Keep-Alive header to its request. Each request from a client creates a new socket connection to the server. The client reads from that socket connection to get the response. If `keepAlive` is not set, the server closes the connection. If the client needs to make a new request, it will establish a new connection.

If the client sends the Keep-Alive header, the server keeps the connection open. When the client sends another request, it uses the same connection. This will continue until either the client or the server decides that the session is over, and one of them closes the connection. (Default = false).

`loopValue`

If this option is enabled (1), then the client progresses through the command list repeatedly until the test's sustain time. If the option is disabled (0) then the client will progress through the command list only once, and then go idle. (Default = 0).

`maxHeaderLen`

Specifies the length of header data. It accepts integer values. Minimum = 1,024, maximum =1,0240. (Default = 1,024).

`maxPersistentRequests`

This option is only applicable if `httpVersion` is set to "1.1" or `httpVersion` is set to "1.0" with `keepAlive` set to true. This option enables you to control the number of transactions that can occur during a single connection.

A value of 0 indicates the maximum possible, in which case IxLoad will create as many transactions as possible for each connection.

If you enter a value to limit the number of transactions, IxLoad limits the number of transactions that can occur during a single TCP connection. If a user reaches the maximum number of transactions and needs to continue communicating with the server, it will close the connection and open a new one. (Default = 1).

`maxPipeline`

This option enables you to control the maximum number of requests that the client will send before waiting for a response. Minimum = 1, maximum = 1,000. (Default = 1).

HTTP pipelining allows a client to send multiple HTTP requests before it has received a response to the first request. A client that does not use HTTP pipelining waits for a response to a request before it sends the next request.

This option is only applicable if `httpVersion` is set to "1.1" or `httpVersion` is set to "1.0" with `keepAlive` set to true.

Setting `maxPipeline` to 1 (the default) effectively disables pipelining; the client will send only one request before stopping to wait for a response.

Setting `maxPipeline` to a value greater than 1 reduces the maximum number of concurrent connections that a test can attain.

If pipelining is enabled, IxLoad pipelines all requests: GET, PUT, POST, HEAD, and DELETE.

Note: If you enable pipelining, you should also consider the value you will enter in the `maxPersistentRequests` field, because it may override the value for `maxPipeline`. For example, if you set the value of `maxPersistentRequests` to '5' instead of "Maximum possible" and set the `maxPipeline` value to 100, pipelining will effectively be nullified because the client will allow only 5 requests to be sent by over an HTTP connection.

`maxSessions`

This value determines the maximum number of connections that a single user can have open at any given time. For example, clients may open multiple connections when their command list contains URLs for multiple servers.

The value for this parameter has an effect on the total number of users that can be configured; increasing the number of concurrent connections decreases the number of users that can be configured. Setting this parameter to 1 allows the maximum numbers of users to be created.

IxLoad enforces these limits for clients. For servers, the limits are the same but not enforced. (Default = 3).

`name`

The name associated with this object, which must be set at object creation.

`privateKey`

If `enableSsl` is true, this is a user's private key. The password must be in binary format, fully decoded. The `importPrivateKey` subcommand can read and decode a certificate held in a disk file. (Default = "").

`privateKeyPassword`

The password used to decode a certificate and private key, when using the `importCertificate` or `importPrivateKey` subcommands. (Default = 0).

`sequentialSession`

Reuse

## HTTP

---

If `enableSsl` is `true`, this option indicates the number of times that a set of keys will be reused after its initial usage. For example, if this value is set to 3, then the keys will be used for four total sessions. (Default = 0).

`sslVersion`

If `enableSsl` is `true`, this is the SSL version be supported by the client. One of

Option	Usage
<code>\$.:HTTP_Client(kSslVersion2)</code>	SSL version 2.0.
<code>\$.:HTTP_Client(kSslVersion3)</code>	SSL version 3.0.
<code>\$.:HTTP_Client(kTlsVersion1)</code>	(Default) TLS version 1.0.

`tcpCloseOption`

This option selects the method used to close connections.

0	(Default) Connections are closed using three way handshake.
1	Connections are closed by sending Reset (RST) segments instead of Finish (FIN) segments
2	Connections are closed using a four-way handshake

`tos`

If `enableTos` is `true`, this option specifies the IP Precedence / TOS (Type of Service) bit setting and Assured Forwarding classes. (Default = "Best Effort 0x0"). If you want to specify the standard choices that are in the GUI, you can use a string representation. To specify any of the other 255 TOS values, specify the decimal value. The default choices are:

"Best Effort (0x0)"	(Default) routine priority
"Class 1 (0x20)"	Priority service, Assured Forwarding class 1
"Class 2 (0x40)"	Immediate service, Assured Forwarding class 2
"Class 3 (0x60)"	Flash, Assured Forwarding class 3
"Class 4 (0x80)"	Flash-override, Assured Forwarding class 4
"Express Forwarding (0xA0)"	Critical-ecp
"Control (0xC0)"	Internet-control

`urlStatsCount`



Number of URL statistics to display in Statistics (StatViewer) window. During a test, IxLoad displays statistics for one or more URLs in the Statistics window at the bottom of the main IxLoad window. You can use this field to restrict the number of per-URL statistics that are displayed, so that the window displays statistics only for the URLs that are most important to you. If you select a large number of URLs, the Statistics window can become difficult to read. Maximum = 1,000, (default=10).

## Value Extraction Settings

`varExtract_enable`

If enabled, IxLoad searches for a match for the string configured in the fields and, if found, applies the value to the variable. It accepts `true` or `false` value.

`varExtract_varName`

This represents the name of the variable.

`varExtract_prefix`

This indicates the characters preceding the value string in the response.

You can specify up to 512 characters, which can be any valid printable ASCII characters.

`varExtract_suffix`

This indicates the characters following the value string in the response.

You can specify up to 512 characters, which can be any valid printable ASCII characters.

`varExtract_location`

This indicates where to search for the value string. It can take three different values: `Header`, `Body`, or `Both`.

## STATISTICS

### EXAMPLE

```
$Activity_HTTPClient1 agent.config \  
-vlanPriority          0 \  
-enableDecompressSupport    0 \  
-enableHttpsProxy        0 \  
-enableSsl              0 \  
-enableUnidirectionalClose  0 \  
-ipPreference           2 \  
-loopValue              1 \  

```

```
-enableLargeHeader      0 \  
-maxPersistentRequests  1 \  
-enableEsm              0 \  
-certificate            "" \  
-sequentialSessionReuse 0 \  
-tos                    0 \  
-maxPipeline            1 \  
-maxHeaderLen           1024 \  
-maxSessions            3 \  
-enableHttpProxy        0 \  
-enableTos              0 \  
-cookieRejectProbability 0.0 \  
-browserEmulation       3 \  
-cookieJarSize          10 \  
-privateKey             "" \  
-commandTimeout         600 \  
-enableIntegrityCheckSupport 0 \  
-commandTimeout_ms      0 \  
-privateKeyPassword     "" \  
-urlStatsCount          10 \  
-followHttpRedirects    0 \  
-tcpCloseOption         0 \  
-enableVlanPriority      0 \  
-esm                    1460 \  
-httpVersion            0 \  
-sslVersion             3 \  
-enableCookieSupport     0 \  
-piggybackAck           true \  
-clientCiphers           "DEFAULT" \  
-httpProxy              "0.0.0.0" \
```

```
-keepAlive          0 \  
-enableCRCCheckSupport 0 \  
-httpsProxy        "0.0.0.0"
```

**SEE ALSO**

[HTTP Client Action](#)

[ixNetTraffic](#)

## HTTP Client Profile

HTTP Client Profile - configure the an HTTP client's functionality.

### SYNOPSIS

```
set HTTP_client_client_network [::IxLoad new ixNetTraffic]
set Activity_newAgent1 [$HTTP_client_client_network activityList.append
set CustomCommandProfile1 [::IxLoad new ixHttpCommandProfile]
$Activity_newAgent1 agent.profileList.appendItem -object $CustomCommandProfile1
```

### DESCRIPTION

An HTTP client profile is added to the `profileList` option of the HTTP Client Agent object using the `appendItem` subcommand from the HTTP Client Agent.

#### Request Headers

The request header is a list of type `ixConfigSequenceContainer` used to hold objects of type `ixResponseHeader`. The elements in this list describe the responses of the Web server to HTTP requests as per the profile specified in the client. You can map multiple header responses to one common profile ID.

```
# Request Headersset my_ixHttpHeaderString [::IxLoad new ixHttpHeaderString]$my_ixHttpHeaderString config \-data "Accept: /*/*"$Activity_newAgent1 agent.headerList.appendItem -object $my_ixHttpHeaderString
```

#### Substring Matching

The HTTP client filter strings received in responses from the server.

```
# Substring Matchset CustomCommandProfile1 [::IxLoad new ixHttpCommandProfile]$CustomCommandProfile1 config \-name "Cus-
tomCommandProfile1" \-substringMatchEnabled true \-userID
"test" \-id 0 \-substring
"a" \-basicAuthenticationEnabled true \-password
"test" \-caseInsensitiveMatch true$CustomCommandProfile1
requestHeaders.clear
```

### SUBCOMMANDS

None.

### OPTIONS

#### Substring options

name

This is the name of the profile that needs to be matched.

---

`caseInsensitivematch`

If this is enabled, then IxLoad ignores the case of the characters in a substring match. The value is 0 for enabled and 1 if disabled. (Default = 0).

`substring`

This is the server response text string to be matched, when enabled. Minimum = 0, maximum =1,024. (Default=0).

`substringMatchEnabled`

If enabled, the response to any command that uses this profile is searched for the text string in the `substring` field. The value is `true` if enabled and `false` if disabled. (Default = `false`).

`basicAuthentication`

If this is enabled the client sends an authorization header to the server requesting for a page. The `userID` and `password` is sent to the server against `Authorization` header like `userID: password` after `base64` encoding. (Default = 0).

`userID`

Identification of the client sending the `basicAuthentication` request. (Default = `userid`).

`password`

Password of the client sending the `basicAuthentication` request. (Default = `pass`).

`randomPageGenEnabled`

If enabled, the GET requests that contain sequence generators in the `pageObject` field send requests for pages in a random order.

If disabled, GET requests that use sequence generators generate requests in alphabetic or numerical order. The value is `true` if enabled and `false` if disabled. (Default = `false`).

## Request Header options

`data`

This contains the name and the value of the header. The request header maps to the profile list through the profile ID declared in the client action. The request header is specified for `GET`, `HEAD`, `PUT`, `POST`, `DELETE` and their SSL counter

## HTTP Client Action

HTTP Client Action - configure the actions that an HTTP client will perform.

### SYNOPSIS

```
set HTTP_client_client_network [::IxLoad new ixNetTraffic]
set Activity_newAgent1 [$HTTP_client_client_network activityList.appendItem
set my_ixHttpAction [::IxLoad new ixHttpAction]
$Activity_newAgent1 agent.actionList.appendItem -object $my_ixHttpAction
```

### DESCRIPTION

An HTTP client action is added to the `actionList` option of the HTTP Client Agent object using the `appendItem` subcommand from the HTTP Client Agent. See the following example:

```
set Traffic1_Network1 [::IxLoad new ixNetTraffic]set Activity_HTTPClient1 [$Traf-
fic1_Network1 activityList.appendItem \set my_ixHttpAction [::IxLoad new ixHt-
tpAction]$my_ixHttpAction config \-profile 0 \-
namevalueargs "" \-destination
"Traffic2_HTTPServer1:80" \-abort "None" \-command
"GET" \-arguments "" \-pageObject
"/1b.html"$Activity_HTTPClient1 agent.actionList.appendItem -object $my_ixHttpAction
```

Each member of the list may be separately addressed and modified using the `ixConfig` subcommands.

### SUBCOMMANDS

The options for this command are configured and read using the standard `config`, `cget`, and `getOption` subcommands defined in the `ixConfig` command. In addition, the following commands are available. Unless otherwise described, no values are returned and an exception is raised for any error found.

`checkConfig`

This subcommand checks the configuration of an individual action.

### OPTIONS

`abort`

This option allows you to abort an operation at one of two places during the interThe following commands support the `abort` option: `GET`, `PUT`, `POST`, `HEAD`, `DELETE`, `GET(SSL)`, `PUT(SSL)`, `POST(SSL)`, `HEAD(SSL)`, and `DELETE(SSL)`.

The types of aborts available are:

Option	Usage

<code>::HttpAction</code> ( <code>kAbortNone</code> ) or <code>"None"</code>	Do not abort transaction. (Default)
<code>::HttpAction</code> ( <code>kAbortBefore</code> ) or <code>"AbortBeforeRequest"</code>	Abort the operation immediately after the TCP connection.
<code>::HttpAction</code> ( <code>kAbortAfter</code> ) or <code>"AbortAfterRequest"</code>	Abort the operation after the operation has been sent to the HTTP server. This option is not valid for SSL connections.

## arguments

This option contains an argument that is used by the various commands defined in `command`. The type of the value depends on the command:

Option	Usage
<code>"GET"</code> , <code>"GET(SSL)"</code>	N/A.
<code>"DELETE"</code>	N/A.
<code>"HEAD"</code> , <code>"HEAD(SSL)"</code>	N/A.
<code>"PUT"</code> , <code>"PUT(SSL)"</code>	The name and path of the file to be posted on the server.
<code>"POST"</code> , <code>"POST(SSL)"</code>	The name and path of the file to be posted on the server.
<code>"{Think}"</code>	The number of milliseconds to pause before executing the next command in the action list.

## command

Selects the HTTP command to be used. One of:

Option	Usage
<code>"GET"</code>	(Default) Retrieves the page specified in the <code>pageObject</code> option.
<code>"GET(SSL)"</code>	Retrieves the page specified in the <code>pageObject</code> option, using SSL. This command must be used if <code>enableSsl</code> is set in the HTTP Client Action.

"DELETE"	Requests that the server delete the page specified in the <code>pageObject</code> option.
"HEAD"	Retrieves only the HTTP headers for the page specified in <code>pageObject</code> option.
"HEAD(SSL)"	Retrieves only the HTTP headers for the page specified in <code>pageObject</code> option. This command must be used if <code>enableSsl</code> is set in the HTTP Client Action.
"PUT"	Stores the page specified in the <code>pageObject</code> option on the server at the path specified in the <code>arguments</code> option.
"PUT(SSL)"	Stores the page specified in the <code>pageObject</code> option on the server at the path specified in the <code>arguments</code> option. This command must be used if <code>enableSsl</code> is set in the HTTP Client Action.
"POST"	Creates a new object linked to the item specified in the <code>pageObject</code> option. The <code>arguments</code> option can be used to set the object's message-ID field.
"POST(SSL)"	Creates a new object linked to the item specified in the <code>pageObject</code> option. The <code>arguments</code> option can be used to set the object's message-ID field. This command must be used if <code>enableSsl</code> is set in the HTTP Client Action.
"{Think}"	Adds a pause (think time) before the next command is executed. Specify the duration of the pause in the <code>arguments</code> option.
"{LoopBegin}"	An IxLoad command that you can add to the Command List to cause the commands between it and the <code>{Loop End}</code> to be executed a specified number of times.
"{LoopEnd}"	Ends the list of commands that will be executed by the preceding <code>{Loop Begin}</code> command.

`destination`

Either the IP address of a real HTTP server or the value of the `-name` option of an HTTP Server Agent. If the HTTP server listens on a port other than the standard (80), enter a colon after the IP address and then enter the port number. If an HTTP Server Agent is used, the port number should agree with the port number associated with the Server Agent. If you are testing an SLB with a virtual IP address (VIP), enter its address here. See the following example:

```
192.168.0.1:80
```

The `destination` option also accepts IPv6 addresses. IxLoad supports all forms of IPv6 addressing except `::dotted-quad` notation (for example, `:::1.2.3.4`).

`namevalueargs`

Name=value arguments for GET, HEAD, POST and PUT commands. Name=value arguments are optional and specify parameter names and values; they can occur in any order. To enter multiple name=value arguments, separate the arguments with ampersands (&). For example:

```
name1=value1&name2=value2& . . .
```



You can include sequence generators and system variables in the name=value arguments. (Default= "")

pageObject

This option contains a page stored on the HTTP server specified in the Destination field. Three formats are available:

- /#n identifies a target that contains n bytes of HTTP data. For example, /#1 is 1 byte of HTTP data. In addition to the default sizes listed, you can cause the HTTP Server agent to generate a custom-size target by specifying the size using the same convention used for the default sizes. For example, to specify a target of 16 bytes, use /#16.
- /nk.htm identifies a target that is an HTML page that is n kilobytes in size. For example, /4k.htm is an 4096-byte HTML page.
- If you have added customized pages, type its path and name into the Page/Object field. See [Using Your Own Web Pages In IxLoad](#) for a description of how to use your own custom pages.

You can also include variables in this parameter.

sendingChunkSize

Chunk size (PUT and POST commands). Enables chunked-transfer encoding if set to a numeric value. Default = "None".

sendMD5ChkSumHeader

If true, an MD5 check sum header is included with the requests sent to the server. Default = 0.

profile

When a HTTP Client Profile is created there is an associated ID, created for each profile. This is incremented by one for each profile. This profile ID maps the Substring match and Request Header together. (Default= -1).

exactTransactions

If enabled, the transaction count is maintained throughout the test. Default = 0.

## EXAMPLE

```
#-----# Add actions to this
client agent#-----set my_
ixHttpAction [::IxLoad new ixHttpAction]$my_ixHttpAction config \-profile
0 \-namevalueargs          "" \-destination
"Traffic2_HTTPServer1:80" \-abort          "None" \-command
"GET" \-arguments          "" \-pageObject
"/1b.html"
```

```
$Activity_HTTPClient1 agent.actionList.appendItem -object $my_ixHttpAction
```

## SEE ALSO

[HTTP Client Agent](#)



## HTTP Server Agent

HTTP Server Agent - configure an HTTP server.

### SYNOPSIS

```
set HTTP_server_server_network [::IxLoad new ixNetTraffic]
set Activity_newServerActivity1 [$HTTP_server_server_network activityList.
appendItem
$Activity_newServerActivity1 agent.config
```

### DESCRIPTION

An HTTP server agent is added to the `activityList` object. The `activityList` object is added to the `ixNetTraffic` object using the `appendItem` subcommand from the `ixConfigSequenceContainer` command.

Each member of the list, however may be separately addressed and modified using the `ixConfig` subcommands.

The set of Web pages available through the server is described in the `webPageList` option, which references response headers held in the `responseHeaderList` option and cookies held in the `cookieList`.

### SUBCOMMANDS

The options for this command are configured and read using the standard `config`, `cget`, and `getOption` subcommands defined in the `ixConfig` command.

In addition, two subcommands are available to load certificates and private keys: `importCertificate` and `importPrivateKey`.

```
importCertificate file
```

Imports a certificate from a disk file, setting the certificate option with the result. For more information, see the description under [HTTP Client Agent](#).

```
importPrivateKey file
```

This subcommand performs the same function, but for the private key. For more information, see the description under [HTTP Client Agent](#).

### OPTIONS

```
acceptSslConnections
```

If `true`, the server will accept incoming SSL connections. (Default = `false`).

```
piggybackAck
```

If `true`, the server includes the ACK for the previous packet in the same packet as the next packet. (Default = `true`).

```
minResponseDelay
```

Minimum length of time, in milliseconds, that the HTTP server delays sending a response.

`maxResponseDelay`

Maximum length of time, in milliseconds, that the HTTP server delays sending a response.

`privateKey`

If the `acceptSslConnections` parameter is true, this parameter specifies a private key in ASCII PEM (Privacy Enhanced Mail) or binary (PKCS#12) format that is used to create a server private key.

`privateKeyPassword`

If the `privateKey` is password-protected (PKCS#12 format), this parameter defines a password for retrieving the key.

`certificate`

If the `acceptSslConnections` parameter is true, this parameter specifies a certifi in ASCII PEM (Privacy Enhanced Mail) format that is used to create a server certificate.

`enableDHsupport`

Enables Diffie-Hellman support for DH keys and ADH or EDH ciphers. (Default = false).

`dhParams`

If the EnableDH support option is selected, this parameter specifies the file that contains a DSA key and certificate. The DSA key is converted to a DH key that can be used in a DH key exchange with an SSL client when the selected cipher is ADH or EDH.

`ServerCiphers`

Defines the server cipher which is one of these listed under Supported Ciphers.

`cookieList`

This is a list of type `ixConfigSequenceContainer` used to hold objects of type `ixCookieObject`. The elements in this list describe the cookies that the server sends to clients. (Default = {}).

`docrootfile`

Selects the file (zip or tar) that defines default directory path for actual files stored on the HTTP server. HTTP clients can retrieve these files. To retrieve the files specify in the `pageObject` option in the client's command list.

`docrootChunkSize`

If `enableChunkEncoding` is true, this option defines the chunk size used for pages in the Docroot file. Specify this value as a min-max range. (Default = 521-1024)

`enable`

Enables the use of this server agent. (Default = true).

`enableEsm`

If true, the use of the `esm` option is enabled. (Default = false).

`enableTos`

Enables the setting of the TOS (Type of Service) bits in the header of the HTTP packets. Use the `tos` option to specify the TOS bit setting.

0	(default) TOS bits not enabled.
1	TOS bits enabled.

`esm`

If `enableEsm` is `true`, this option specifies the TCP Maximum Segment Size in the MSS (RX) field. Otherwise, the TCP Maximum Segment Size is 1,460 bytes. (Default = 1,460).

`enableMD5Checksum`

If `true`, the server calculates checksums for the pages it sends to the client. See `integrityCheckOption` in HTTP Server Agent and `MD5option` in `ixWebPageOb` (Default = `false`).

`enablePerServerPerURLstat`

If `true`, the statistics from a returned page, records the server IP address from where the page is sent. (Default = `false`).

`enableVlanPriority`

VLAN Priority can be set on a per-activity basis or on a per-network (NetTraffic) basis. This parameter sets the VLAN priority for the activity. An activity's VLAN Priority bit setting takes precedence over a network's Priority bit setting. If `true`, `IxLoad` sets the VLAN Priority bit in traffic from this activity. Configure the VLAN priority value in `vlanPriority`. (Default = `false`).

`vlanPriority`

When `enableVlanPriority` is `true`, this option accepts the `vlan` priority value.

`httpPort`

The port number to which the HTTP server will respond to non-SSL requests. To specify multiple listening ports, enter the port numbers, separated by commas (,). You can specify up to 50 listening ports. (Default = 80).

`httpsPort`

The port number to which the HTTP server will respond to SSL requests. To specify multiple listening ports, enter the port numbers, separated by commas (,). You can specify up to 50 listening ports. (Default = 443).

`integrityCheckOption`

Type of checksum calculated for pages requested from the `docroot` file. In order to send checksums, `enableMD5Checksum` must be `true`. Valid values for this option are the following strings:

Option	Usage
--------	-------

Custom MD5	(Default) MD5 checksum in IxLoad-specific header.
Standard MD5	MD5 checksum in RFC 2616-compliant header.
Standard & Custom MD5	MD5 checksum in both IxLoad-specific and RFC-compliant headers
Disable MD5	No checksum is sent.

`enableChunkEncoding`

If true, Chunk Transfer-Encoding is enabled. (Default = false).

`name`

The name associated with this object, which must be set at object creation.

`requestTimeout`

The amount of time that the server will wait for input on an open connection before closing the session with a '408' error. The legal values are from 1 to 64,000 seconds. (Default = 300).

`responseHeaderList`

This is a list of type `ixConfigSequenceContainer` used to hold objects of type `ixResponseHeader`. The elements in this list describe the responses of the Web server to requests—both returned page contents and other messages. (Default = {}).

`tcpCloseOption`

This option helps the server to close connections. It accepts integer value. (Default = 0).

0	(Default) Connections are closed using three way handshake
1	Connections are closed by sending Reset (RST) segments instead of Finish (FIN) segments
2	Connections are closed using a four-way handshake

`tos`

If `enableTos` is true, this option specifies the IP Precedence / TOS (Type of Serbit setting and Assured Forwarding classes. (Default = "0"). The choices are:

0	(Default) (0x000) routine
32	(0x0020) priority service, Assured Forwarding class 1
64	(0x0040) immediate service, Assured Forwarding class 2
96	(0x0060) flash, Assured Forwarding class 3

128	(0x0080) flash-override, Assured Forwarding class 4
160	(0x00A0) critical-ecp
192	(0x00C0) internet-control

urlStatsCount

Number of URL statistics to display in Statistics (StatViewer) window. During a test, IxLoad displays statistics for one or more URLs in the Statistics window at the bottom of the main IxLoad window. You can use this field to restrict the number of per-URL statistics that are displayed, so that the window displays statistics only for the URLs that are most important to you. If you select a large number of URLs, the Statistics window can become difficult to read. Maximum = 1,000, (Default = 10).

webPageList

This is a list of type `ixConfigSequenceContainer` used to hold objects of type `ixWebPageObject`. The elements in this list describe the headers of the Web pages returned by the server. (Default = {}).

customPayloadList

This is a list of type `ixConfigSequenceContainer` used to hold objects of type `CustomPayloadObject`. The elements in this list describe the payload of the Web pages returned by the server. (Default = {}). Two predefined `CustomPayloadObjects` exist, `AsciiCustomPayload` and `HexCustomPayload`.

## STATISTICS

### EXAMPLE

```
$Activity_HTTPServer1 agent.config \
-vlanPriority          0 \
-maxResponseDelay     0 \
-docrootChunkSize     "512-1024" \
-enablePerServerPerURLstat 0 \
-enableEsm            0 \
-certificate          "" \
-tos                  0 \
-enableMD5Checksum    false \
-httpPort             "80" \
-httpsPort            "443" \
```

-esm	1460 \
-enableTos	0 \
-integrityCheckOption	"Custom MD5" \
-enableChunkEncoding	false \
-privateKey	"" \
-privateKeyPassword	"" \
-urlStatsCount	10 \
-tcpCloseOption	0 \
-enableVlanPriority	0 \
-docrootfile	"" \
-dhParams	"" \
-requestTimeout	300 \
-ServerCiphers	"DEFAULT" \
-acceptSslConnections	0 \
-piggybackAck	true \
-enableDHsupport	0 \
-minResponseDelay	0

### **SEE ALSO**

[ixCookieContent](#)

[ixResponseHeader](#)

[PageObject](#)



## ixCookieContent

ixCookieContent—Defines a cookie response for a Web page.

### SYNOPSIS

```
$UserCookie cookieContentList.appendItem -object $lastName
$Activity_newServerActivity1 agent.cookieList.appendItem -object $User
```

### DESCRIPTION

The `ixCookieContent` command is used to construct a cookie response associated with a cookie, described in a `ixCookieObject`. The list of cookie contents are normally added to a `ixCookieObject` at the time of its creation.

```
set firstName [::IxLoad new ixCookieContent]$firstName config \-domain
"" \-name                "firstName" \-maxAge
"" \-value                "Joe" \-other
"" \-path                 "$UserCookie cook-
ieContentList.appendItem -object $firstName
```

### SUBCOMMANDS

The options for this command are configured and read using the standard `config`, `cget`, and `getOption` subcommands defined in the `ixConfig` command.

### OPTIONS

domain

The domain for which the cookie is valid. If omitted, it applies to the entire domain for the HTTP server. (Default = "").

maxAge

The lifetime of the cookie, in seconds. After the time elapses, the client should discard the cookie. A value of zero means the cookie should be discarded immediately. If blank, the cookie is discarded at the end of the browser session. (Default = "").

name

The name part of the `name = value` pair being defined. (Default = "name").

other

A comment associated with the cookie. (Default = "").

path

The subset of URLs to which this cookie applies. If omitted, it applies to all URLs for the server. (Default = "")

value

The value part of the name = value pair being defined. (Default = "value").

**EXAMPLE**

```
set firstName [::IxLoad new ixCookieContent]$firstName config \-domain
"" \-name "firstName" \-maxAge
"" \-value "Joe" \-other
"" \-path ""$UserCookie cook-
ieContentList.appendItem -object $firstNameset lastName [::IxLoad new ixCook-
ieContent]$lastName config \-domain "" \-name
"lastName" \-maxAge "" \-value
"Smith" \-other "" \-path
""$UserCookie cookieContentList.appendItem -object $lastName$Activity_newServer-
Activity1 agent.cookieList.appendItem -object $UserCookie
```

**SEE ALSO**

[HTTP Server Agent](#)

## ixCookieObject

ixCookieObject—Defines a cookie.

### SYNOPSIS

```
set HTTP_server_server_network [::IxLoad new ixNetTraffic]
set Activity_newServerActivity1 [$HTTP_server_server_network activityList.appendItem
$Activity_newServerActivity1 agent.cookieList.appendItem -object $UserCookie
```

### DESCRIPTION

The ixCookieObject command is used to construct a cookie for the server. The list of cookie contents are normally added to a HTTP Server Agent at the time of its creation.

```
set UserCookie [::IxLoad new CookieObject]$UserCookie config \-mode
3 \-type                2 \-name
"UserCookie" \-description                "Name of User"
```

The cookies are referenced by the actual Web page in an ixWebPageObject included in the webPageList option of the HTTP Server Agent.

### SUBCOMMANDS

The options for this command are configured and read using the standard config, cget, and getOptions subcommands defined in the ixConfig command.

### OPTIONS

cookieContentList

This is a list of type ixConfigSequenceContainer used to hold objects of type ixCookieContent. The elements in this list describe the cookie contents associated with this cookie. (Default = {}).

description

A description for the cookie. (Default = "").

mode

Determines how the cookies in the cookie group should be handled by the HTTP server that receives them. One of:

Option	Usage
<code>::CookieObject (kModeIgnore)</code>	Causes the server to discard these cookies when it receives them from the client. The IxLoad HTTP server does not add cookies received with this mode to its statistics. Therefore, the statistics for the number of cookies sent by the client will be greater than the number of cookies received by the IxLoad HTTP server.

<code>::CookieObject (kModeReflectSetCookie1)</code>	Causes the server to return the cookies to the client in a Set-Cookie format header.
<code>::CookieObject (kModeReflectSetCookie2)</code>	Causes the server to return the received cookie data to the client in a Set-Cookie2 format header.
<code>::CookieObject (kModeNormal)</code>	(default) Causes the server to perform the functions described by the cookies.

name

The name part of the cookie object being defined. (Default = "name").

readOnly

Indicates that the cookie may not be deleted without resetting this flag. (Default = false)

type

The type of the cookie. One of:

Option	Usage
<code>::CookieObject(kTypeSetCookie1)</code> "1"	Use the original cookie specification, as per RFC 2109.
<code>::CookieObject(kTypeSetCookie2)</code> "2"	(default) Use the cookie 2 specification, as per RFC 2965.

**EXAMPLE**

```
set UserCookie [::IxLoad new CookieObject]$UserCookie config \-mode
3 \-type                2 \-name
"UserCookie" \-description "Name of User"$UserCookie
cookieContentList.clear
```

**SEE ALSO**

[HTTP Server Agent](#)

## ixResponseHeader

ixResponseHeader—Defines a response for a Web page.

### SYNOPSIS

```
set HTTP_server_server_network [::IxLoad new ixNetTraffic]
set Activity_newServerActivity1 [$HTTP_server_server_network activityL options...
$Activity_newServerActivity1 agent.responseHeaderList.appendItem options...
```

### DESCRIPTION

The `ixResponseHeader` command is used to describe the responses of the Web server to request both returned page contents and other messages. See the following example:

```
set 200_OK [::IxLoad new ResponseHeader]$200_OK config \-mimeType
"text/plain" \-expirationMode 0 \-code
"200" \-name "200_OK" \-lastModifiedMode
1 \-lastModifiedIncrementEnable false \-lastModifiedDateTimeValue
"2005/02/02 21:55:04" \-lastModifiedIncrementFor 1 \-
expirationDateTimeValue "2005/03/04 21:55:04" \-
expirationAfterRequestValue 3600 \-expirationAfterLastModifiedValue
3600 \-lastModifiedIncrementBy 5 \-description
"OK"$200_OK responseList.clear
```

The response header referenced by the actual Web page in an `ixWebPageObject` included in the `responseHeaderList` option of the HTTP Server Agent.

### SUBCOMMANDS

The options for this command are configured and read using the standard `config`, `cget`, and `getOption` subcommands defined in the `ixConfig` command.

### OPTIONS

`code`

The number returned by response. HTTP response codes are defined in Section 10 of RFC 2616. (Default = "200").

`description`

A commentary description for the response. (Default = "OK").

`expirationAfterLastModifiedValue`

If `expirationMode` is set to "AfterLastModified," this is the number of seconds after the page's last modified value, at which time the page will expire. The last modified value is set in `lastModifiedDateTimeValue`, `lastModifiedIncrementEnable`, `lastModifiedIncrementBy`, and `lastModifiedIncrementFor` options. . (Default = 3,600).

`expirationAfterRequestValue`

If `expirationMode` is set to "AfterRequest," this is the number of seconds after which the page will expire. (Default = 3,600).

`expirationDateTimeValue`

If `expirationMode` is set to "DateTime," this is the date and time at which the page will expire. The format of this field is "YYYY/MM/DD HH:MM:SS." For example, "2004/12/31 23:59:59." (Default = "2004/12/31 23:59:59").

`expirationMode`

The means by which the page's expiration is published. One of:

Option	Usage
<code>\$.:ResponseHeader (kExpirationModeNever)</code>	(Default) The page never expires.
<code>\$.:ResponseHeader (kExpirationModeDateTime)</code>	The page expires after a certain date and time, specified in <code>e</code> .
<code>\$.:ResponseHeader (kExpirationModeAfterRequest)</code>	The page expires after a certain amount of time, specified in <code>e</code> .
<code>\$.:ResponseHeader (kExpirationModeAfterLastModified)</code>	The page expires after a certain amount of time following the last modified date and time, specified in <code>e</code> .

`lastModifiedDateTimeValue`

If `lastModifiedMode` is set to "DateTime," then this is the value to be returned for the last modified date/time. This value may be incremented for subsequent responses through use of the `lastModifiedIncrementEnable`, `lastModified` and `lastModifiedIncrementFor` options. (Default = "2004/12/31 23:59:59").

`lastModifiedIncrementBy`

If `lastModifiedMode` is set to "DateTime" and `lastModifiedIncrementEnable` is set to `true`, then this is the number of seconds to increment the `lastModifiedDateTimeValue` (Default = 5).

`lastModifiedIncrementEnable`

If `lastModifiedMode` is set to "DateTime," this option enables the incrementing of `lastModifiedDateTimeValue` by `lastModifiedIncrementBy` as modified by `l`. (Default = `false`).

`lastModifiedIncrementFor`

If `lastModifiedMode` is set to "DateTime" and `lastModifiedIncrementEnable` is set to `true`, then this is the number of times that the page is referenced before the last modified date/time is incremented as specified in `lastModifiedIncrementBy`. (Default = 1).

`lastModifiedMode`

This option determines if and how the last modified field will be published for the page. One of:

Option	Usage
<code>\$.:ResponseHeader</code> ( <code>kLastModifiedModeNever</code> )	(Default) No last modification time is pub
<code>\$.:ResponseHeader</code> ( <code>kLastModifiedModeDateTime</code> )	A last modification date/time is published as specified in <code>lastModifiedDateTimeValue</code> , <code>lastModifiedIncrementEnable</code> , <code>lastModifiedIncrementBy</code> , and <code>lastModifiedIncrementFor</code> .

`contentType`

The MIME type for the page. The types: "text/plain," "text/html," and "text/xml" are predefined, but any legal type may be set. (Default = "text/plain").

`name`

The name of the response. (Default = "200\_OK").

`responseList`

A list of additional headers, to be sent with the response. This list is of type `ixConfigSequenceContainer`; items are added to the list via the `appendItem` sub-command. Each element of the list must be of the form "key: value" where `key` is a value HTTP header key. (Default = {}).

Items are added to this list using the `-data` option. See the following example:

```
$responseHeader responseList.appendItem -data "key1:value1"
```

You can also include variables in this parameter. See [Using Sequence Generators in HTTP Client Commands and Server Header Name=Value Fields on page 6-57](#).

### EXAMPLE

```
set 200_OK [::IxLoad new ResponseHeader]$200_OK config \-contentType
"text/plain" \-expirationMode 0 \-code
"200" \-name "200_OK" \-lastModifiedMode
1 \-lastModifiedIncrementEnable false \-lastModifiedDateTimeValue
"2005/02/02 21:55:04" \-lastModifiedIncrementFor 1 \-
expirationDateTimeValue "2005/03/04 21:55:04" \-
expirationAfterRequestValue 3600 \-expirationAfterLastModifiedValue
3600 \-lastModifiedIncrementBy 5 \-description
"OK"$200_OK responseList.clear
```

### SEE ALSO

[HTTP Server Agent](#)

[PageObject](#)

## PageObject

`ixWebPageObject` —Defines a Web page supported by an HTTP Server Agent.

### SYNOPSIS

```
set HTTP_server_server_network [::IxLoad new ixNetTraffic]
set Activity_newServerActivity1 [$HTTP_server_server_network activityOptions...
$Activity_newServerActivity1 agent.webPageList.appendItem options...
```

### DESCRIPTION

The `PageObject` command is used to describe the Web pages that are available from the Web server, along with the response header described in `ixResponseHeader` and cookie described in `ixCookieContent`. See the following example:

```
set my_PageObject [::IxLoad new PageObject]$my_PageObject config \
-Md5Option "0" \
-payloadType"range" \
-payloadFile"<specify file>" \
-page"/1b.html" \
-payloadSize "1-1" \
-customPayloadId -1 \
-response$200_OK
$Activity_newServerActivity1 agent.webPageList.appendItem -object $my_PageObject
```

### SUBCOMMANDS

The options for this command are configured and read using the standard `config`, `cget`, and `getOption` subcommands defined in the `ixConfig` command.

### OPTIONS

`cookie`

This option links to an element in the `cookieList` of the enclosing HTTP Server Agent. It should match the contents of the `name` field of one of the `ixCookieContent` members of that list. (Default = "").

`response`

This option links to an element in the `responseHeaderList` of the enclosing HTTP Server Agent. It should match an `ixResponseHeader` object. (Default = "").

`chunkSize`



If `enableChunkEncoding` is `true` (in [HTTP Server Agent](#)), this option defines the chunk size used for the page, in bytes. (Default = "1").

#### Md5Option

Type of checksum generated for page object and sent along with page data to the client. In order to send checksums, `enableMD5Checksum` in the HTTP Server Agent must be `true`. The valid values for this option are:

Option	Usage
0	(Default) Custom MD5. MD5 checksum in IxLoad-specific header.
1	Standard MD5. MD5 checksum in RFC 2616-compliant header.
2	Standard & Custom MD5. MD5 checksum in both IxLoad-specific and RFC-compliant headers
3	Disable MD5. No checksum is sent.

#### page

The URL of the HTML page that clients can retrieve from the HTTP Server Agent. The path is relative to the root directory of the Ixia server port. You can enter an asterisk (\*) at any point on the path, and the server will treat it as a match for any number of directories.

For example, if you configure the page's URL as `/home/liesl/*/pup.html`, a server would serve the page if it received any of the following GET requests:

```
/home/liesl/pics/pup.html
/home/liesl/0/temp/pup.html
/home/liesl/pup.html
(Default = "/newPage.html").
```

#### payloadFile

If `payloadType` is set to "file," this field specifies the file that will be returned. Make sure to specify the entire path to the file in this specification. Also note that the directory separator `\` must be represented as `\\` within the string. (Default = "<specify file>").

If `payloadType` is set to "customPayload", this field specifies an existing custom payload type or a new one.

#### payloadSize

If `payloadType` is set to "range," this field specifies the amount of data returned. Specify the size of the data as a minimum size and a maximum size. For example, to specify a minimum size of 1,024 bytes and a maximum of 2,048, specify `1,024-2,048`. To specify a single fixed amount of data, specify the a single value. (Default = 4,096).

#### payloadType

Indicates the type of payload that will be returned for this page reference. One of:

Option	Usage
<code>::PageObject</code> <code>(kPayloadTypeRange)</code> or "range"	(Default) Causes the Server Agent to generate data automatically. The value in <code>payloadSize</code> indicates the amount of data to return.
<code>::PageObject</code> <code>(kPayloadTypeFile)</code> or "file"	Causes the Server Agent to return the actual file indicated in the <code>payloadFile</code> option. See Using Your Own Web Pages In IxLoad for instructions on making your own pages available on the Server Agent.
"customPayload"	Causes the server to return a response that contains syn(generated) data that includes a payload that you create. Specify the payload in the <code>payloadFile</code> option.

**EXAMPLE**

```

set my_PageObject [::IxLoad new PageObject]$my_PageObject config \-payloadType
"range" \-payloadFile                "<specify file>" \-page
"/1b.html" \-payloadSize              "1-1" \-response
$200_OK$Activity_newServerActivity1 agent.webPageList.appendItem -object $my_PageOb-
ject
    
```

**SEE ALSO**

[HTTP Server Agent](#)

[ixResponseHeader](#)

[ixCookieContent](#)

## CustomPayloadObject

**CustomPayloadObject** —Defines a custom payload object. A custom payload can contain up to 4096 bytes of ASCII or hexadecimal data.

### SYNOPSIS

```
set HTTP_server_server_network [::IxLoad new ixNetTraffic]
set Activity_newServerActivity1 [$HTTP_server_server_network activityList.appendItem
options...
$Activity_HTTPServer1 agent.customPayloadList.appendItem -object $As-
ciiCustomPayload...
```

### DESCRIPTION

The `CustomPayloadObject` is used to configure a custom payload object. This object is declared in the `payloadFile` option of `ixWebPageObject`.

### SUBCOMMANDS

The options for this command are configured and read using the standard `config`, `cget`, and `getOption` subcommands defined in the `ixConfig` command.

### OPTIONS

`repeat`

This field determines how often the custom payload appears in the payload space.

If set to true, `IxLoad` divides the total payload space into 4096-byte blocks, and inserts the custom payload into the first block and into all subsequent 4096-byte blocks. If the custom payload is shorter than 4096 bytes, `IxLoad` pads the remaining space with zeroes (0).

If set to false, `IxLoad` inserts the custom payload once, either at the beginning of the payload space or at offset value. If the custom payload is shorter than the total payload space, `IxLoad` pads the remaining space with generated data (the same type of data that would be generated if you set `payloadType` to `Range`).

`name`

This indicates the name of the `customPayloadObject`.

`asciiPayloadValue`

According to the option specified in `payloadMode`, this option accepts the custom payload value in ASCII.

`payloadMode`

Specifies 0 (ASCII) or 1 (hexadecimal) value.

`offset`

Defines the number of bytes from the beginning of the payload field where the payload is inserted.

hexPayloadValue

According to the option specified in `payloadMode`, this option accepts the custom payload value in hexadecimal.

payloadPosition

This can be one of:

`startWith`: inserts a payload at the beginning of the payload field of the response.

`endWith`: inserts a payload at the end of the payload field.

`insertAtMiddle`: inserts a payload at a location within the payload field.

### EXAMPLE

```
set my_PageObject1 [::IxLoad new PageObject]$my_PageObject1 config \-payloadType
"customPayload" \-payloadFile "AsciiCustomPayload" \-
page "/4k.html" \-payloadSize
"4096-4096" \-customPayloadId 0 \-response
$200_OK1$Activity_HTTPServer1 agent.webPageList.appendItem -object $my_
PageObject1set AsciiCustomPayload [::IxLoad new CustomPayloadObject]$As-
ciiCustomPayload config \-repeat false \-name
"AsciiCustomPayload" \-asciiPayloadValue "Ixia-Ixload-Http-
Server-Custom-Payload" \-payloadmode 0 \-offset
1 \-hexPayloadValue "" \-payloadPosition
"Start With" \-id 0$Activity_HTTPServer1 agent.-
customPayloadList.appendItem -object $AsciiCustomPayload
```

### SEE ALSO

[HTTP Server Agent](#)

[PageObject](#)

## Supported Ciphers

The following ciphers are supported by IxLoad HTTPS clients and servers.

### SSL 2.0 Cipher Suites

Cipher Suite	Description
RC4-MD5	RC4 data encryption using 128-bit keys and MD5 message digest.
EXP-RC4-MD5	Export version of RC4-MD4 using 40-bit keys.
IDEA-CBC-MD5	IDEA data encryption using 128-bit keys with Cipher Block Chaining and MD5 message digest.
DES-CBC-MD5	DES data encryption using 64-bit keys with Cipher Block Chaining and MD5 message digest.
DES-CBC3-MD5	Triple-DES data encryption using 192-bit keys with Cipher Block Chaining and MD5 message digest.

### SSL 3.0 Cipher Suites

Cipher Suite	Description
NULL-MD5	No data encryption, MD5 message digest.
NULL-SHA	No data encryption, SHA-1 message digest.
EXP-RC4-MD5	Export version of RC4-MD5 using 40-bit keys.
RC4-MD5	RC4 data encryption using 128-bit keys and MD5 message digest.
RC4-SHA	RC4 data encryption using 128-bit keys and SHA-1 message digest.
EXP-RC2-CBC-MD5	Exportable cipher using RC2 data encryption with 40-bit keys, Cipher Block Chaining, and MD5 message digest.
IDEA-CBC-SHA	IDEA encryption with Cipher Block Chaining, RSA authentication, and SHA-1 message digest.
EXP-DES-CBC-SHA	Export version of DES-CBC-SHA using 40-bit keys.
DES-CBC-SHA	DES encryption using 168-bit keys, Cipher Block Chaining, RSA authentication, and SHA-1 message digest.

DES-CBC3-SHA	Triple-DES encryption using 168-bit keys, Cipher Block Chaining, and SHA-1 message digest.
EXP-EDH-DSS-DES-CBC-SHA	Export version of EDH-DSS-DES-CBC-SHA using 40-bit keys.
EDH-DSS-DES-CBC3-SHA	Ephemeral Diffie-Hellman key exchange with DSS authentication, Triple-DES encryption with Cipher Block Chaining, and SHA-1 message digest.
EXP-EDH-RSA-DES-CBC-SHA	Export version of EDH-RSA-DES-CBC-SHA using 40-bit keys.
EDH-RSA-DES-CBC-SHA	DES encryption with Cipher Block Chaining, RSA authentication, Ephemeral Diffie-Hellman key exchange, and SHA-1 message digest.
EDH-RSA-DES-CBC3-SHA	Triple-DES encryption with Cipher Block Chaining, RSA authentication, Ephemeral Diffie-Hellman key exchange, and SHA-1 message digest.
EXP-ADH-RC4-MD5	Exportable cipher using RC4 encryption with 40-bit keys, Anonymous Diffie-Hellman key exchange, and MD5 message digest.
EXP-ADH-DES-CBC-SHA	Export version of ADH-DES-CBC-SHA using 40-bit keys.
ADH-DES-CBC-SHA	DES encryption with Cipher Block Chaining, Anonymous Diffie-Hellman key exchange, and SHA-1 message digest.
ADH-DES-CBC3-SHA	Triple-DES encryption with Cipher Block Chaining, Anonymous Diffie-Hellman key exchange, and SHA-1 message digest.
EXP1024-DES-CBC-SHA	Exportable cipher with DES encryption and Cipher Block Chaining, RSA authentication, and SHA-1 message digest.
EXP1024-RC4-SHA	Exportable cipher with RC4 encryption, RSA authentication, and SHA-1 message digest.
EXP1024-DHE-DSS-DES-CBC-SHA	Exportable cipher with DES encryption and Cipher Block Chaining, Ephemeral Diffie-Hellman key exchange, DSS authentication, and SHA-1 message digest.
EXP1024-DHE-DSS-RC4-SHA	Exportable cipher with RC4 encryption, DSS authentication, Ephemeral Diffie-Hellman key exchange, and SHA-1 message digest.
DHE-DSS-RC4-SHA	RC4 encryption using 128-bit keys, DSS authentication, Diffie-Hellman key exchange, and SHA-1 message digest.

**TLS 1.0 Cipher Suites**

Cipher Suite	Description
NULL-MD5	No encryption, RSA authentication and MD5 message digest.
NULL-SHA	No encryption, RSA authentication and SHA-1 message digest.
EXP-RC4-MD5	Export version of RC4-MD5.
RC4-MD5	RC4 encryption using 128-bit keys, RSA authentication, and MD5 message digest.
RC4-SHA	RC4 encryption using 128-bit keys, RSA authentication, and SHA-1 message digest.
EXP-RC2-CBC-MD5	Exportable cipher with RC2 encryption using 40-bit keys and Cipher Block Chaining, RSA authentication, and MD5 message digest.
IDEA-CBC-SHA	IDEA encryption with Cipher Block Chaining, RSA authentication, and MD5 message digest.
EXP-DES-CBC-SHA	Export version of DES-CBC-SHA using 40-bit keys.
DES-CBC-SHA	DES encryption with Cipher Block Chaining, RSA authentication, and SHA-1 message digest.
DES-CBC3-SHA	Triple-DES encryption with Cipher Block Chaining, RSA authentication, and SHA-1 message digest.
EXP-EDH-DSS-DES-CBC-SHA	Exportable cipher with DES encryption using 40-bit keys and Cipher Block Chaining, DSS authentication, and SHA-1 message digest.
EDH-DSS-DES-CBC3-SHA	Triple-DES encryption with Cipher Block Chaining, DSS authentication, Ephemeral Diffie-Hellman key exchange, and SHA-1 message digest.
EXP-EDH-RSA-DES-CBC-SHA	Exportable cipher with DES encryption using 40-bit keys and Cipher Block Chaining, RSA authentication, and SHA-1 message digest.
EDH-RSA-DES-CBC-SHA	DES encryption with Cipher Block Chaining, RSA authentication, Ephemeral Diffie-Hellman key exchange, and SHA-1 message digest.
EDH-RSA-DES-CBC3-SHA	Triple-DES encryption with Cipher Block Chaining, RSA authentication, Ephemeral Diffie-Hellman key exchange, and SHA-1 message digest.
EXP-ADH-RC4-MD5	Export version of ADH-RC4-MD5.

ADH-RC4-MD5	RC4 encryption with 128-bit keys, Anonymous Diffie-Hellman key exchange, and MD5 message digest.
EXP-ADH-DES-CBC-SHA	Export version of ADH-DES-CBC-SHA using 40-bit keys.
ADH-DES-CBC-SHA	DES encryption with Cipher Block Chaining, Anonymous Diffie-Hellman key exchange, and SHA-1 message digest.
ADH-DES-CBC3-SHA	Triple-DES encryption with Cipher Block Chaining, Anonymous Diffie-Hellman key exchange, and SHA-1 message digest.
EXP1024-DES-CBC-SHA	Exportable cipher with DES encryption and Cipher Block Chaining, RSA authentication, and SHA-1 message digest.
EXP1024-RC4-SHA	Exportable cipher using RC4 encryption with 56-bit keys, RSA authentication, and SHA-1 message digest.
EXP1024-DHE-DSS-DES-CBC-SHA	Exportable cipher using DES encryption and Cipher Block Chaining, Diffie-Hellman key exchange, and SHA-1 message digest.
EXP1024-DHE-DSS-RC4-SHA	Export version of DHE-DSS-RC4-SHA using 56-bit keys.
DHE-DSS-RC4-SHA	RC4 encryption with 128-bit keys, DSS authentication, Diffie-Hellman key exchange, and SHA-1 message digest.

**Ciphers Selected from the Generic Ciphers List**

Cipher Attribute	Selected Cipher Suite
DEFAULT	Default list of cipher suites. Includes all cipher suites with the following attributes, listed in order of decreasing preference: <ol style="list-style-type: none"> <li>1. ALL cipher suites (see below).</li> <li>2. Cipher suites without ADH key exchange (you cannot add ADH ciphers to the list separately).</li> <li>3. Cipher suites with RC4 encryption and RSA authentication.</li> </ol> SSL v2 cipher suites.
ALL	Includes all cipher suites except those in the eNULL suite.
HIGH	Cipher suites with keys larger than 128 bits.
MEDIUM	Cipher suites with 128-bit keys.



LOW	Cipher suites with 40- or 56-bit keys, but not including exportable cipher suites.
EXP,EXPORT	Exportable cipher suites.
EXPORT40	Exportable cipher suites with 40-bit keys.
EXPORT56	Exportable cipher suites with 56-bit keys.
eNULL,NULL	Cipher suites with no encryption.
aNULL	Cipher suites with anonymous key exchange (Anonymous Diffie-Hellman).
kRSA,RSA	Cipher suites with RSA key exchange.
kEDH	Cipher suites with Ephemeral Diffie-Hellman key exchange.
aRSA	Cipher suites with RSA authentication.
aDSS,DSS	Cipher suites with DSS authentication.
TLSv1	TLS v.1 cipher suites.
SSLv3	SSL v.3 cipher suites.
SSLv2	SSL v.2 cipher suites.
DH	Cipher suites with Diffie-Hellman key exchange (including Anonymous Diffie-Hellman).
ADH	Cipher suites with Anonymous Diffie-Hellman key exchange.
3DES	Cipher suites with Triple-DES encryption.
DES	Cipher suites with DES encryption (not including those with Triple-DES).
RC4	Cipher suites with RC4 encryption.
RC2	Cipher suites with RC2 encryption.
IDEA	Cipher suites with IDEA encryption.
MD5	Cipher suites with MD5 message digest.
SHA1,SHA	Cipher suites with SHA-1 message digest.

## Using Sequence Generators in HTTP Client Commands and Server Header Name=Value Fields

Several HTTP fields allow you to include variables in order to generate large numbers of different objects such as page names or HTTP header values.

If the destination of an HTTP client command is an IxLoad HTTP server, you can insert variables into the Page/Object fields to cause the HTTP server to return dynamically-generated pages with unique names.

- You can use the following variables:
- Numbers 0-9
- Letters A-Z and a-z

The letter variables are case-sensitive; IxLoad considers the variable strings "AA" and "aa" to be different.

You can combine the variables with fixed text to create the page names. For example, you can enter page[00-] to create a range of unique user names that begin with the characters "page" (page00, page01, and so on).

To insert the variables into a field, enclose them in square brackets ( [ ] ). To specify a range, separate the minimum and maximum values with a hyphen (-). For example, [00-10] specifies a range of 00 through 10.

The number of variables you insert determines the width of the generated strings. For example, the variable "00" can generate the strings 00 - 99. The variable string "000" can generate the strings 000 - 999.

Similarly, "AA" can generate strings that consist of all the two-letter combinations from AA to zz. "AAA" can generate strings that consist of all the three-letter combinations from AAA to zzz.

You can use a single variable string and allow IxLoad to generate strings up to the maximum value of the string or, you can use two variable strings together to restrict the generated strings to a certain range.

See the following example:

[0- ] will generate all the values 0 - 9 (0, 1, 2, 3 . . . 9).

[0-5] will generate all the values 0 - 5.

[00- ] will generate all the values 00 - 99 (00, 01, 02, 03. . .97, 98, 99).

[00-50] will generate all the values 0 - 50.

[A- ] will generate all the values A - z (A, B, C . . . z).

[A-K] will generate all the values A - K.

[AA- ] will generate all the values AA - zz (AA, AB, AC. . .zx, zy, zz).

[AA-KK] will generate all the values AA - KK.

When IxLoad has generated the final string, if the test configuration requires additional strings, IxLoad returns to the starting value of the variable and continues to generate strings until no more are required. In this case, the generated strings will not be unique.

If you include more than one variable, the number of unique pages IxLoad generates is equivalent to the multiple of the maximum values of all the variables. For example, if you specify the page name as:

Page[01-10]\_of\_[01-99].

the IxLoad server can potentially generate 990 (10\*99) unique pages with names "Page01\_of\_01" through "Page10\_of\_99." The server will only generate all the pages if it receives requests for all of them from clients.



**Note:** If you include multiple variables, the start and end fields must be the same width.

You can also configure the HTTP server to include wildcards in page names. For example, you can configure the server for a Web page named "Page\*\_of\_\*" where '\*' is considered to be the wildcard. A client that used the variables in the previous example would receive all the pages requested.

## Using System Variables

In addition to the letter and number variables, there are several system variables you can use. If you include the system variables in a page name, IxLoad replaces the system variable with the appropriate value from the current test configuration. You can use the letter, number, and system variables with HTTP name = value arguments.

You specify the system variables by enclosing them in parentheses (). Like the letter number variables, you must use the system variables in the page name in the URL, not in the path. Table 6-15 describes the system variables.

### System Variables for Use in Page Names

System Variable	Description
(\$port-id)	ID of the Ixia port that the client is running on. When the IxLoad HTTP server returns the page, it expands (\$port-id) into <Chassis-Card-Port>.
(\$user-id)	Integer value representing the user that the client is simulating.
(\$sourceip-int)	Integer representation of the source IP address of the simulated user. For 128-bit IPv6 addresses, this is in the format of four integers of the form int-int-int-int.

(\$sourceip)	Source IP address, in dotted-decimal format, of the simulated user.
(\$sourceport)	TCP session Source port. Note: You must use (\$sourceport) only in the page name portion of the URL, not in the path. See the following example: Correct: /dir/filename(\$sourceport).html Incorrect: /dir(\$sourceport)/filename.html

### Example 1

```
http://ixiacom.com/page($sourceip)-($sourceport).html
```

If this page was retrieved by client 1 from source IP 192.168.1.1 and source port 3589, the page that would be returned would be:

```
http://ixiacom.com/page192.168.1.1-3589.html
```

If the same command was used by a different client from source IP 192.168.2.10 and source port 46990, the page that would be returned would be:

```
http://ixiacom.com/page192.168.2.10-46990.html
```

### Example 2

Suppose that a command uses the POST/GET method with a name=value argument of:  
`?user=customer($user-id) &password=pwd&clientport=($sourceport)`

Then the command list:

```
POST/GET, servername, myfile.html, argument
```

could expand to:

```
POST/GET, servername, myfile.html, ?user=customer1&pass
```

for the first simulated user, and to:

```
POST/GET, servername, myfile.html, ?user=customer99&pass
```

for the 99th simulated user.

### Example 3

Suppose that you needed to use a GET command to generate unique user names and passwords for a use on a login page. You could create a page URL of:

```
http://server/login.html?user=user($port-id)_($user-id) &password=pwd
```

IxLoad expands (`$port-id`) to chassis-card-port and (`$user-id`) to the ID of the simulated user on the port. The pages retrieved might be:

```
http://server/login.html?user=user0-1-1_11&password=pwdhttp://server-
/login.html?user=user0-1-2_47&password=pwd
```

A command that uses (`$port-id`) and (`$user-id`) in this way ensures that the user names generated are unique throughout all the ports used in the test.

## Statistics

The HTTP statistics are listed in this section.

### HTTP Server Statistics

The table below describes the statistics that IxLoad records for the HTTP servers. Statistics in the results files and reports are averaged over all ports. If a statistic for an interval is missing, IxLoad interpolates it from the statistic immediately prior to it and the statistic after it.

For TCP statistics, see TCP, Run State, and Curve Segment Statistics.

The test results are available from the location defined on the User Directories window. See User Directories.

Statistic	Description
HTTP Requests Received	Number of HTTP requests received by the servers. The statistics show the number of requests for each URL (page).
HTTP Requests Successful	Number of complete and positive HTTP responses (2xx- and 3xx-range responses) sent to the clients. The statistics show the number of requests for each URL (page).
HTTP Requests Failed	Number of HTTP requests from the clients that failed for any reason. The statistics show the number of requests for each URL (page).
HTTP Requests Failed (404)	Number of HTTP requests that failed due to missing files (error 404). The statistics show the number of requests for each URL (page)
HTTP Requests Failed (50x)	Number of HTTP requests that failed due to lack of resources (500-series errors). The statistics show the number of requests for each URL (page).

HTTP Requests Failed (Write Error)	Number of HTTP requests that failed due to a socket write error. The statistics show the number of requests for each URL (page).
HTTP Requests Failed (Aborted)	Number of HTTP requests that failed because the HTTP transaction was aborted. The statistics show the number of requests for each URL (page).
HTTP Sessions Rejected (503)	Service Unavailable. Number of HTTP sessions that could not be established due to lack of resources on the server.
HTTP Sessions Timeouts (408)	<p>Number of HTTP 408 responses sent. This statistic includes all 408 responses sent regardless of whether they were received for a pending HTTP request or not.</p> <p>IxLoad counts 408 responses differently depending on whether or not a client has a pending HTTP request:</p> <p>If a client has an HTTP request pending and it receives a 408 response, IxLoad increments the HTTP Received 408, HTTP Requests Failed (4xx), and HTTP Requests Failed statistics.</p> <p>If a client does not have an HTTP request pending and it receives a 408 response, IxLoad only increments the HTTP Received 408 statistic.</p>
HTTP Transactions Active	Number of HTTP transactions transferring HTTP commands or data.
HTTP Responses Sent (1xx)	<p>Number of 100-series responses sent.</p> <p>100-series responses indicate a provisional response, consisting only of the Status-Line and optional headers, and is terminated by an empty line.</p> <p>Refer to RFC 2616, Section 10, for a full description.</p>
HTTP Responses Sent (2xx)	<p>Number of 200-series responses sent.</p> <p>200-series responses indicate that the client's request was successfully received, understood, and accepted.</p> <p>Refer to RFC 2616, Section 10, for a full description.</p>
HTTP Responses Sent (3xx)	<p>Number of 300-series (Redirection) responses sent.</p> <p>300-series responses indicate that further action needs to be taken by the user agent in order to fulfill the request.</p> <p>Refer to RFC 2616, Section 10, for a full description.</p>

HTTP Responses Sent (4xx)	<p>Number of 400-series (Bad Request) responses received.</p> <p>400-series responses indicate that the request could not be understood by the server due to malformed syntax.</p> <p>Refer to RFC 2616, Section 10, for a full description.</p>
HTTP Responses Sent (5xx)	<p>Number of 500-series (Server Error) responses sent.</p> <p>500-series responses indicate that the server is aware that it has erred or is incapable of performing the request.</p> <p>Refer to RFC 2616, Section 10, for a full description.</p>
HTTP Responses Sent (Other)	<p>Number of responses sent that were not 100-, 200-, 300-, 400-, or 500-series responses.</p>
<b>Throughput Statistics</b>	
HTTP Bytes Received	<p>Number of HTTP bytes received by the servers.</p> <p>If you probe the network link with a sniffer, this statistic is not the same as the total amount of TCP payload that appears on the link. The total amount of TCP payload can be greater than this statistic due to increases caused by retransmits.</p> <p>SSL-encrypted payload data is included in this statistic but SSL handshake overhead is not.</p>
HTTP Bytes Sent	<p>Number of HTTP bytes sent by the servers.</p> <p>If you probe the network link with a sniffer, this statistic is not the same as the total amount of TCP payload that appears on the link. The total amount of TCP payload can be greater than this statistic (increased by retransmits) or less than this statistic (decreased by broken or reset connections).</p> <p>SSL-encrypted payload data is included in this statistic but SSL handshake overhead is not.</p>
HTTP Content Bytes Received	<p>Number of bytes received that were HTTP content.</p>
HTTP Content Bytes Sent	<p>Number of bytes sent that were HTTP content.</p>
<b>Cookie Statistics</b>	
HTTP Cookies Received	<p>Number of cookies received by the server.</p>
HTTP Cookies Sent	<p>Number of cookies sent by the server.</p>

HTTP Cookies Received With Matching ServerID	Number of cookies received in which the server ID matched the server name. Server IDs are unique per Ixia port, and can be sent in a cookie as a VALUE for a server NAME in a NAME=VALUE pair. The servers track these IDs, and when a server NAME received from a client matches one tracked by the server, the server tries to match the server ID that was sent as the VALUE.
HTTP Cookies Received With Non-matching ServerID	Number of cookies received in which the server ID did not match the server name.
<b>Transfer Encoding Statistics</b>	
HTTP Chunked Encoded Responses Sent	Number of HTTP responses sent that used chunked-transfer encoding.
HTTP Total Chunks Sent	Total number of chunked-transfer chunks sent.
<b>Content-MD5 Statistics</b>	
HTTP Content-MD5 Requests Received	Number of requests received that included Content-MD5 headers.
HTTP Content-MD5 Check Successful	Number of requests for which the MD5 checksum calculated by the server matched the checksum in the requests' Content-MD5 header.
HTTP Content-MD5 Check Failed	Number of requests for which the MD5 checksum calculated by the server did not match the checksum in the requests' Content-MD5 header.



## HTTP Server Conditional View Statistics

The table below describes the conditional view statistics that IxLoad records for the HTTP servers. Statistics in the results files and reports are averaged over all ports. If a statistic for an interval is missing, IxLoad interpolates it from the statistic immediately prior to it and the statistic after it.

For TCP statistics, see TCP, Run State, and Curve Segment Statistics.

The test results are available from the location defined on the User Directories window. See User Directories.

The QoE Detective column in the table indicates the views in which a statistic is available:

**IP:** per-IP view

**User:** per-User view

**VLAN:** per-VLAN view

**All:** all views

Statistic	QoE Detective	Description
HTTP TCP Connections Accepted	IP, VLAN	Number of requests to establish TCP connections accepted by the server. This statistic is only available in QoE Detective view.
HTTP TCP Connections Closed	IP, VLAN	Number of TCP connections that ended normally. This statistic is only available in QoE Detective view.
HTTP TCP Connections Failed	IP, VLAN	Number of TCP connections that did ended abnormally, for any reason. This statistic is only available in QoE Detective view.
HTTP TCP Connections Failed Due to Socket Error	IP, VLAN	Number of TCP connections that did ended abnormally due to a socket error. This statistic is only available in QoE Detective view.

HTTP Server Sessions Timeouts (408)	IP, VLAN	<p>Number of HTTP 408 responses sent. This statistic includes all 408 responses sent regardless of whether they were received for a pending HTTP request or not.</p> <p>IxLoad counts 408 responses differently depending on whether or not a client has a pending HTTP request:</p> <p>If a client has an HTTP request pending and it receives a 408 response, IxLoad increments the HTTP Received 408, HTTP Requests Failed (4xx), and HTTP Requests Failed statistics.</p> <p>If a client does not have an HTTP request pending and it receives a 408 response, IxLoad only increments the HTTP Received 408 statistic.</p>
HTTP Server Sessions Rejected (503)	IP, VLAN	Service Unavailable. Number of HTTP sessions that could not be established due to lack of resources on the server.
HTTP Server Requests Received	IP, VLAN	Number of HTTP requests received by the servers. The statistics show the number of requests for each URL (page).
HTTP Server Requests Successful	IP, VLAN	Number of complete and positive HTTP responses (2xx- and 3xx-range responses) sent to the clients. The statistics show the number of requests for each URL (page).
HTTP Server Responses Sent (1xx)	IP, VLAN	<p>Number of 100-series responses sent.</p> <p>100-series responses indicate a provisional response, consisting only of the Status-Line and optional headers, and is terminated by an empty line.</p> <p>Refer to RFC 2616, Section 10, for a full description.</p>
HTTP Server Responses Sent (2xx)	IP, VLAN	<p>Number of 200-series responses sent.</p> <p>200-series responses indicate that the client's request was successfully received, understood, and accepted.</p> <p>Refer to RFC 2616, Section 10, for a full description.</p>
HTTP Server Responses Sent (3xx)	IP, VLAN	<p>Number of 300-series (Redirection) responses sent.</p> <p>300-series responses indicate that further action needs to be taken by the user agent in order to fulfill the request.</p> <p>Refer to RFC 2616, Section 10, for a full description.</p>
HTTP Server Responses Sent (4xx)	IP, VLAN	<p>Number of 400-series (Bad Request) responses received.</p> <p>400-series responses indicate that the request could not be understood by the server due to malformed syntax.</p> <p>Refer to RFC 2616, Section 10, for a full description.</p>

HTTP Server Responses Sent (5xx)	IP, VLAN	Number of 500-series (Server Error) responses sent. 500-series responses indicate that the server is aware that it has erred or is incapable of performing the request. Refer to RFC 2616, Section 10, for a full description.
HTTP Server Responses Sent (Other)	IP, VLAN	Number of responses sent that were not 100-, 200-, 300-, 400-, or 500-series responses.
HTTP Server Requests Failed	IP, VLAN	Number of HTTP requests from the clients that failed for any reason. The statistics show the number of requests for each URL (page).
HTTP Server Requests Failed (404)	IP, VLAN	Number of HTTP requests that failed due to missing files (error 404). The statistics show the number of requests for each URL (page)
HTTP Server Requests Failed (50x)	IP, VLAN	Number of HTTP requests that failed due to lack of resources (500-series errors). The statistics show the number of requests for each URL (page).
HTTP Server Requests Failed (Write Error)	IP, VLAN	Number of HTTP requests that failed due to a socket write error. The statistics show the number of requests for each URL (page).
HTTP Server Bytes Received	IP, VLAN	Number of HTTP bytes received by the servers. If you probe the network link with a sniffer, this statistic is not the same as the total amount of TCP payload that appears on the link. The total amount of TCP payload can be greater than this statistic due to increases caused by retransmits. SSL-encrypted payload data is included in this statistic but SSL handshake overhead is not.
HTTP Server Bytes Sent	IP, VLAN	Number of HTTP bytes sent by the servers. If you probe the network link with a sniffer, this statistic is not the same as the total amount of TCP payload that appears on the link. The total amount of TCP payload can be greater than this statistic (increased by retransmits) or less than this statistic (decreased by broken or reset connections). SSL-encrypted payload data is included in this statistic but SSL handshake overhead is not.

HTTP Server Transactions Active	IP, VLAN	Number of HTTP transactions transferring HTTP commands or data.
HTTP Server Cookies Sent	IP, VLAN	Number of cookies sent by the server.
HTTP Server Cookies Received	IP, VLAN	Number of cookies received by the server.
HTTP Server Cookies Received With Matching ServerID	IP, VLAN	Number of cookies received in which the server ID matched the server name. Server IDs are unique per Ixia port, and can be sent in a cookie as a VALUE for a server NAME in a NAME=VALUE pair. The servers track these IDs, and when a server NAME received from a client matches one tracked by the server, the server tries to match the server ID that was sent as the VALUE.
HTTP Server Cookies Received With Non-matching ServerID	IP, VLAN	Number of cookies received in which the server ID did not match the server name.
HTTP Server Content Bytes Received	IP, VLAN	Number of bytes received that were HTTP content.
HTTP Server Content Bytes Sent	IP, VLAN	Number of bytes sent that were HTTP content.

### HTTP Server per-URL Statistics

The table below describes the statistics that IxLoad records for the HTTP servers. Statistics in the results files and reports are averaged over all ports. If a statistic for an interval is missing, IxLoad interpolates it from the statistic immediately prior to it and the statistic after it.

For TCP statistics, see TCP, Run State, and Curve Segment Statistics.

The test results are available from the location defined on the User Directories window. See User Directories.

Statistic	Description
<i>The following statistics are available only for the first 'N' distinct URLs configured in the list of HTTP Server Web Pages, where 'N' is the value for 'Max Number of URLs' in the 'Per URL Stat Settings' on the HTTP Server's Advanced Options tab.</i>	
HTTP Requests Received	Number of HTTP requests received by the servers. The statistics show the number of requests for each URL (page).
HTTP Requests Successful	Number of complete and positive HTTP responses (2xx- and 3xx-range responses) sent to the clients. The statistics show the number of requests for each URL (page).
HTTP Requests Failed	Number of HTTP requests from the clients that failed for any reason. The statistics show the number of requests for each URL (page).
HTTP Requests Failed (404)	Number of HTTP requests that failed due to missing files (error 404). The statistics show the number of requests for each URL (page)
HTTP Requests Failed (50x)	Number of HTTP requests that failed due to lack of resources (500-series errors). The statistics show the number of requests for each URL (page).
HTTP Requests Failed (Write Error)	Number of HTTP requests that failed due to a socket write error. The statistics show the number of requests for each URL (page).
HTTP Responses Sent	Total number of HTTP responses of all types sent.
HTTP Responses Sent (1xx)	Number of 100-series responses sent. 100-series responses indicate a provisional response, consisting only of the Status-Line and optional headers, and is terminated by an empty line. Refer to RFC 2616, Section 10, for a full description.
HTTP Responses Sent (2xx)	Number of 200-series responses sent. 200-series responses indicate that the client's request was successfully received, understood, and accepted. Refer to RFC 2616, Section 10, for a full description.

HTTP Responses Sent (3xx)	Number of 300-series (Redirection) responses sent. 300-series responses indicate that further action needs to be taken by the user agent in order to fulfill the request. Refer to RFC 2616, Section 10, for a full description.
HTTP Responses Sent (4xx)	Number of 400-series (Bad Request) responses received. 400-series responses indicate that the request could not be understood by the server due to malformed syntax. Refer to RFC 2616, Section 10, for a full description.
HTTP Responses Sent (5xx)	Number of 500-series (Server Error) responses sent. 500-series responses indicate that the server is aware that it has erred or is incapable of performing the request. Refer to RFC 2616, Section 10, for a full description.
HTTP Responses Sent (Other)	Number of responses sent that were not 100-, 200-, 300-, 400-, or 500-series responses.
HTTP Chunked Encoded Responses Sent	Number of HTTP responses sent that used chunked-transfer encoding.
HTTP Total Chunks Sent	Total number of chunked-transfer chunks sent.
HTTP Average Chunk Size	Average size of the chunks sent.
HTTP Average Chunks per Response	Average number of chunks sent for each HTTP response.
Content-MD5 Statistics	
HTTP Content-MD5 Requests Received	Number of requests received that included Content-MD5 headers.
HTTP Content-MD5 Check Successful	Number of requests for which the MD5 checksum calculated by the server matched the checksum in the requests' Content-MD5 header.
HTTP Content-MD5 Check Failed	Number of requests for which the MD5 checksum calculated by the server did not match the checksum in the requests' Content-MD5 header.

## HTTP Client Statistics

The table below lists the statistics IxLoad reports for HTTP clients. Statistics in the results files and reports are averaged over all ports. If a statistic for an interval is missing, IxLoad interpolates it from the statistic immediately prior to it and the statistic after it.



**Note:** The HTTP client statistics do not include the bytes transmitted and received for the SSL handshake.

The test results are available from the location defined on the User Directories window. See User Directories.

For TCP statistics, see TCP, Run State, and Curve Segment Statistics.

Statistic	Description
<b>Transaction Statistics</b>	
HTTP Requests Sent	Number of HTTP requests sent by the clients. The statistics show the number of requests for each URL.
HTTP Requests Successful	Number of positive HTTP responses (2xx- and 3xx-range responses) received by the clients. The statistics show the number of requests for each URL.
HTTP Intermediate Responses Received (1xx)	Number of 100-series (Informational) responses received. 100-series responses indicate a provisional response, consisting only of the Status-Line and optional headers, and terminated by an empty line. Refer to RFC 2616, Section 10, for a full description.
HTTP Requests Successful (2xx)	Number of 200-series (Successful) responses received. 200-series responses indicate that the client's request was successfully received, understood, and accepted.
HTTP Requests Successful (3xx)	Number of 300-series (Redirection) responses received. 300-series responses indicate that further action needs to be taken by the user agent in order to fulfill the request.
HTTP Requests Successful (301)	Number of 301 (Moved Permanently) responses received. 301 responses indicate that the requested resource has been assigned a new permanent URI and any future references to this resource should use one of the returned URIs.

HTTP Requests Successful (302)	Number of 302 (Found) responses received. 302 responses indicate that the requested resource resides temporarily under a different URI.
HTTP Requests Successful (303)	Number of 303 (See Other) responses received. 303 responses indicate that the response to the request can be found under a different URI and should be retrieved using a GET method on that resource.
HTTP Requests Successful (307)	Number of 307 (Temporary Redirect) responses received. 307 responses indicate that the requested resource resides temporarily under a different URI.
HTTP Requests Failed	Number of HTTP requests that failed for any reason. The statistics show the number of requests for each URL (page).
HTTP Requests Failed (Write)	Number of HTTP requests that failed due to a socket write error. The statistics show the number of requests for each URL (page).
HTTP Requests Failed (Read)	Number of HTTP requests that failed due to a socket read error. The statistics show the number of requests for each URL (page).
HTTP Requests Failed (Bad Header)	Number of HTTP requests that failed due to a defective HTTP header. The statistics show the number of requests for each URL (page).
HTTP Requests Failed (4xx)	Number of 4xx-range responses received by the clients in response to an HTTP request. The statistics show the number of requests for each URL (page). 408 responses are counted separately by the HTTP Session Timeout (408) statistic and may or may not also be included in the HTTP Requests Failed (4xx) count. See the description of HTTP Session Timeout (408) for more information.
HTTP Requests Failed (400)	Bad Request. Number of requests that failed due to a syntax error in the URL. The statistics show the number of requests for each URL (page).
HTTP Requests Failed (401)	Unauthorized. Number of requests that failed due to because the server did not receive the correct user name or password from the browser. The statistics show the number of requests for each URL (page).
HTTP Requests Failed (403)	Forbidden. Number of requests that failed due to because the name or password supplied by the browser are incorrect. The statistics show the number of requests for each URL (page).



HTTP Requests Failed (404)	Not Found. Number of requests that failed because requested object is not stored on the server on the path supplied. The statistics show the number of requests for each URL (page).
HTTP Requests Failed (407)	Proxy Authentication Required. Number of requests that failed because access to the URL requires authentication with a proxy server.
HTTP Requests Failed (408)	Timeout. Number of requests that failed due to communications between the client and server taking too long. The statistics show the number of requests for each URL (page).
HTTP Requests Failed (4xx other)	Number of HTTP requests that failed for reasons other than a Bad Request (400), Unauthorized (401), Forbidden (403), Not Found (404), Proxy Authentication Required (407), or Timeout (408) error. The statistics show the number of requests for each URL (page).
HTTP Requests Failed (5xx)	Number of HTTP requests that failed due to lack of resources on the server (HTTP 500-series errors). This statistic is only incremented if the client had issued a request to the server before receiving the 5xx response. The statistics show the number of requests for each URL (page).
HTTP Requests Failed (505)	HTTP Version not Supported. Number of requests that failed because the server does not support the HTTP version used by the client. The statistics show the number of requests for each URL (page).
HTTP Requests Failed (5xx other)	Number of requests that failed for reasons other than an HTTP version mis-match (505). The statistics show the number of requests for each URL (page).
HTTP Requests Failed (other)	Number of requests that failed that could not be classified.
HTTP Requests Failed (Timeout)	Number of HTTP requests that failed because the clients did not receive a response within 600 seconds. The statistics show the number of requests for each URL (page).
HTTP Requests Failed (Aborted)	Number of HTTP requests that ended prematurely due to events outside HTTP or TCP. For example, if any HTTP requests are pending when the Ramp-Down period ends, those requests are aborted by IxLoad. The statistics show the number of requests for each URL (page).

HTTP Session Timeouts (408)	<p>Number of HTTP 408 responses received. This statistic includes all 408 responses received regardless of whether they were received for a pending HTTP request or not.</p> <p>IxLoad counts 408 responses differently depending on whether or not a client has a pending HTTP request:</p> <ul style="list-style-type: none"> <li>If a client has an HTTP request pending and it receives a 408 response, IxLoad increments the HTTP Received 408, HTTP Requests Failed (4xx), and HTTP Requests Failed statistics.</li> </ul> <p>If a client does not have an HTTP request pending and it receives a 408 response, IxLoad only increments the HTTP Received 408 statistic.</p>
HTTP Sessions Rejected (503)	Service Unavailable. Number of HTTP sessions that could not be established due to lack of resources on the server.
HTTP Aborted Before Request	Number of HTTP requests aborted just before sending the request on an open TCP connection.
HTTP Aborted After Request	Number of HTTP requests aborted just after sending the request on an open TCP connection.
HTTP Users Active	Number of HTTP users simulated.
<b>Throughput Statistics</b>	
HTTP Bytes Sent	<p>Number of HTTP bytes transmitted by the clients.</p> <p>If you probe the network link with a sniffer, this statistic is not the same as the total amount of TCP payload that appears on the link. The total amount of TCP payload can be greater than this statistic (increased by retransmits) or less than this statistic (decreased by broken or reset connections).</p> <p>SSL-encrypted payload data is included in this statistic but SSL handshake overhead is not (HTTP only).</p>
HTTP Bytes Received	<p>Number of HTTP bytes received by the clients.</p> <p>If you probe the network link with a sniffer, this statistic is not the same as the total amount of TCP payload that appears on the link. The total amount of TCP payload can be greater than this statistic due to increases caused by retransmits.</p> <p>SSL-encrypted payload data is included in this statistic but SSL handshake overhead is not (HTTP only).</p>
HTTP Content Bytes Sent	Number of bytes of HTTP data sent.

HTTP Content Bytes Received	Number of bytes of HTTP data received.
HTTP Decompressed Content Bytes Received	Number of bytes of HTTP data decompressed.
<b>Latency Statistics</b>	
HTTP Connect Time (us)	<p>Average time elapsed between the time the client sends a SYN packet and the time it receives the SYN/ACK.</p> <p>The units for this statistic are microseconds.</p> <p>Note for Tcl API users: This is a weighted statistic. If you are using this statistic in a Tcl script, use the <i>kWeightedAverage</i> aggregation type.</p>
HTTP Time To First Byte (us)	<p>Average time elapsed before clients received the first byte of an HTTP response.</p> <p>The units for this statistic are microseconds.</p> <p>Note for Tcl API users: This is a weighted statistic. If you are using this statistic in a Tcl script, use the <i>kWeightedAverage</i> aggregation type.</p>
HTTP Time To Last Byte (us)	<p>Average time elapsed before clients received the last byte of an HTTP response.</p> <p>The units for this statistic are microseconds.</p> <p>Note for Tcl API users: This is a weighted statistic. If you are using this statistic in a Tcl script, use the <i>kWeightedAverage</i> aggregation type.</p>
<b>Cookie Statistics</b>	
HTTP Cookies Received	Number of cookies received by the clients.
HTTP Cookies Sent	Number of cookies sent by the clients.
HTTP Cookies Rejected	<p>Number of cookies rejected by the clients. Clients may reject cookies for the following reasons:</p> <ul style="list-style-type: none"> <li>• Cookie jar is full</li> <li>• Path specified in the cookie is not a subset of the URI requested</li> <li>• Domain of the requesting host does not match the cookie domain</li> </ul> <p>Cookie Reject Probability was greater than 0 and cookie was randomly selected for rejection</p>

HTTP Cookies Rejected - (Path Match Failed)	Number of cookies rejected by the clients because the path specified in the cookie was not available on the server.
HTTP Cookies Rejected - (Domain Match Failed)	Number of cookies rejected by the clients because the cookie was sent by a server outside the domain specified in the cookie.
HTTP Cookies Rejected - (Cookiejar Overflow)	Number of cookies rejected by the clients because their cookie jars were full.
HTTP Cookies Rejected - (Probabalistic Reject)	Number of cookies rejected because the clients were configured to reject a percentage of all cookies at random.
HTTP Cookie headers Rejected - (Memory Overflow)	<p>Number of "Set-Cookie" or "Set-Cookie2" headers which were not processed fully due to insufficient memory.</p> <p>If Large Header Support is enabled, IxLoad monitors the available memory while it processes a "Set-Cookie" or "Set-Cookie2" header.</p> <p>If the amount of free memory declines to the point that IxLoad cannot continue processing the header, IxLoad drops the remainder of the header. If this occurs, IxLoad cannot determine the number of cookies that were in the un-processed portion of the header, so the Cookies Rejected total may be inaccurate; the Memory Overflow statistic is an indication of this.</p>
<b>Test Objective Statistics</b>	
HTTP Simulated Users	Number of users to be simulated during the test.
HTTP Concurrent Connections	Number of concurrent connections maintained during the test.
HTTP Connections	Total number of connections established by the clients.
HTTP Connection Attempts	Total number of connections attempted.

HTTP Transactions	Total number of transactions completed by the clients.
HTTP Bytes	Amount of HTTP data sent and received by the clients, in bytes.
<b>Test Objective Rate Statistics</b>	
HTTP Connection Rate	Rate at which the client established HTTP connections.
HTTP Connection Attempt Rate	Rate at which the client attempted to establish HTTP connections.
HTTP Transaction Rate	Rate at which the client completed HTTP transactions.
HTTP Throughput	Rate at which the client sent and received HTTP traffic.
<b>Content Encoding Statistics</b>	
<b>Note:</b> HTTP 1.0 does not support compression (content encoding). If you run a test using HTTP 1.0, the content encoding statistics are zero.	
Content-Encoded Responses Received	Total number of encoded (compressed) pages received.
Gzip Content-Encoding Received	Number of gzip-encoded pages received.
Deflate Content-Encoding Received	Number of deflate-encoded pages received.
Unrecognized Content-Encoding Received	Number of pages received encoded with an unknown encoding method.
Content-Encoded Responses Decode Successful	Total number of pages successfully decoded.

Gzip Content-Encoding Decode Successful	Number of gzip-encoded pages successfully decoded.
Deflate Content-Encoding Decode Successful	Number of deflate-encoded pages successfully decoded.
Content-Encoded Responses Decode Failed	Total number of pages that could not be decoded.
Gzip Content-Encoding Decode Failed	Number of gzip-encoded pages that could not be decoded for all reasons.
Deflate Content-Encoding Decode Failed	Number of deflate-encoded pages that could not be decoded for all reasons.
Gzip Content-Encoding Decode Failed - Data Error	Number of gzip-encoded pages that could not be decoded because the files were corrupted.
Gzip Content-Encoding Decode Failed - Decoding Error	Number of gzip-encoded pages that could not be decoded due to an internal error in IxLoad.
Deflate Content-Encoding Decode Failed - Data Error	Number of deflate-encoded pages that could not be decoded because the files were corrupted.
Deflate Content-Encoding Decode Failed - Decoding Error	Number of deflate-encoded pages that could not be decoded due to an internal error in IxLoad.
<b>Transfer Encoding Statistics</b>	

Chunked Transfer-Encoded Responses Received	Number of pages received with chunked transfer encoding.
Chunked Transfer-Encoding Decode Successful	Number of chunked transfer-encoded pages successfully decoded.
Chunked Transfer-Encoding Decode Failed	Number of chunked transfer-encoded pages that could not be decoded.
<b>Integrity Check Statistics</b>	
Content-MD5 Responses Received	Number of page checksums received in Content-MD5 headers.
Content-MD5 Check Successful	Number of checksums calculated by the client that matched the Content-MD5 checksums in the response headers. <b>Note:</b> Zero-byte reads do not contain any data for comparison, so they are always considered successful. Therefore, every time the client performs a read of zero bytes, this statistic is incremented.
Content-MD5 Check Failed	Number of checksums calculated by the client that did not match the Content-MD5 checksums in the response headers.
Custom-MD5 Responses Received	Number of page checksums received in Custom-MD5 (IxLoad-specific) headers.
Custom-MD5 Check Successful	Number of checksums calculated by the client that matched the Custom-MD5 checksums in the response headers. <b>Note:</b> Zero-byte reads do not contain any data for comparison, so they are always considered successful. Therefore, every time the client performs a read of zero bytes, this statistic is incremented.
Custom-MD5 Check Failed	Number of checksums calculated by the client that did not match the Content-MD5 checksums in the response headers.

## HTTP Client QoE Detective Statistics

The table below lists the QoE Detective statistics IxLoad reports for HTTP clients. Statistics in the results files and reports are averaged over all ports. If a statistic for an interval is missing, IxLoad interpolates it from the statistic immediately prior to it and the statistic after it.



**Note:** The HTTP client statistics do not include the bytes transmitted and received for the SSL handshake.

The test results are available from the location defined on the User Directories window. See User Directories.

The QoE Detective column in the table indicates the views in which a statistic is available:

**IP:** per-IP view

**User:** per-User view

**VLAN:** per-VLAN view

**All:** all views

For TCP statistics, see TCP, Run State, and Curve Segment Statistics.

Statistic	QoE Detective	Description
<b>Test Objective Statistics</b>		
HTTP Client Concurrent Connections	All	Number of concurrent connections maintained during the test.
HTTP Client Connections	All	Total number of connections established by the clients.
HTTP Client Connection Attempts	All	Total number of connections attempted.
HTTP Client Transactions	All	Total number of transactions completed by the clients.
HTTP Client Bytes Received and Transmitted	All	Amount of HTTP data sent and received by the clients, in bytes.



<b>Transaction Statistics</b>		
HTTP Client Requests Sent	All	Number of HTTP requests sent by the clients. The statistics show the number of requests for each URL.
HTTP Client Requests Successful	All	Number of positive HTTP responses (2xx- and 3xx-range responses) received by the clients. The statistics show the number of requests for each URL.
HTTP Client Intermediate Responses Received (1xx)	All	Number of 100-series (Informational) responses received. 100-series responses indicate a provisional response, consisting only of the Status-Line and optional headers, and terminated by an empty line. Refer to RFC 2616, Section 10, for a full description.
HTTP Client Requests Successful (2xx)	All	Number of 200-series (Successful) responses received. 200-series responses indicate that the client's request was successfully received, understood, and accepted.
HTTP Client Requests Successful (3xx)	All	Number of 300-series (Redirection) responses received. 300-series responses indicate that further action needs to be taken by the user agent in order to fulfill the request.
HTTP Client Requests Successful (301)	All	Number of 301 (Moved Permanently) responses received. 301 responses indicate that the requested resource has been assigned a new permanent URI and any future references to this resource should use one of the returned URIs.
HTTP Client Requests Successful (302)	All	Number of 302 (Found) responses received. 302 responses indicate that the requested resource resides temporarily under a different URI.
HTTP Client Requests Successful (303)	All	Number of 303 (See Other) responses received. 303 responses indicate that the response to the request can be found under a different URI and should be retrieved using a GET method on that resource.
HTTP Client Requests Successful (307)	All	Number of 307 (Temporary Redirect) responses received. 307 responses indicate that the requested resource resides temporarily under a different URI.
HTTP Client Requests Failed	All	Number of HTTP requests that failed for any reason. The statistics show the number of requests for each URL (page).

HTTP Client Requests Failed (Write)	All	Number of HTTP requests that failed due to a socket write error. The statistics show the number of requests for each URL (page).
HTTP Client Requests Failed (Read)	All	Number of HTTP requests that failed due to a socket read error. The statistics show the number of requests for each URL (page).
HTTP Client Requests Failed (Bad Header)	All	Number of HTTP requests that failed due to a defective HTTP header. The statistics show the number of requests for each URL (page).
HTTP Client Requests Failed (4xx)	All	Number of 4xx-range responses received by the clients in response to an HTTP request. The statistics show the number of requests for each URL (page). 408 responses are counted separately by the HTTP Session Timeout (408) statistic and may or may not also be included in the HTTP Requests Failed (4xx) count. See the description of HTTP Session Timeout (408) for more information.
HTTP Client Requests Failed (400)	All	Bad Request. Number of requests that failed due to a syntax error in the URL. The statistics show the number of requests for each URL (page).
HTTP Client Requests Failed (401)	All	Unauthorized. Number of requests that failed due to because the server did not receive the correct user name or password from the browser. The statistics show the number of requests for each URL (page).
HTTP Client Requests Failed (403)	All	Forbidden. Number of requests that failed due to because the name or password supplied by the browser are incorrect. The statistics show the number of requests for each URL (page).
HTTP Client Requests Failed (404)	All	Not Found. Number of requests that failed because requested object is not stored on the server on the path supplied. The statistics show the number of requests for each URL (page).
HTTP Client Requests Failed (407)	All	Proxy Authentication Required. Number of requests that failed because access to the URL requires authentication with a proxy server.
HTTP Client Requests Failed (408)	All	Timeout. Number of requests that failed due to communications between the client and server taking too long. The statistics show the number of requests for each URL (page).

HTTP Client Requests Failed (4xx other)	All	Number of HTTP requests that failed for reasons other than a Bad Request (400), Unauthorized (401), Forbidden (403), Not Found (404), Proxy Authentication Required (407), or Timeout (408) error. The statistics show the number of requests for each URL (page).
HTTP Client Requests Failed (5xx)	All	Number of HTTP requests that failed due to lack of resources on the server (HTTP 500-series errors). This statistic is only incremented if the client had issued a request to the server before receiving the 5xx response. The statistics show the number of requests for each URL (page).
HTTP Client Requests Failed (505)	All	HTTP Version not Supported. Number of requests that failed because the server does not support the HTTP version used by the client. The statistics show the number of requests for each URL (page).
HTTP Client Requests Failed (5xx other)	All	Number of requests that failed for reasons other than an HTTP version mis-match (505). The statistics show the number of requests for each URL (page).
HTTP Requests Failed (other)	All	Number of requests that failed that could not be classified.
HTTP Client Requests Failed (Timeout)	All	Number of HTTP requests that failed because the clients did not receive a response within 600 seconds. The statistics show the number of requests for each URL (page).
HTTP Client Requests Failed (Aborted)	All	Number of HTTP requests that ended prematurely due to events outside HTTP or TCP. For example, if any HTTP requests are pending when the Ramp-Down period ends, those requests are aborted by IxLoad. The statistics show the number of requests for each URL (page).
HTTP Client Session Timeouts (408)	All	Timeout. Number of requests that failed due to communications between the client and server taking too long. The statistics show the number of requests for each URL (page).
HTTP Client Sessions Rejected (503)	All	Service Unavailable. Number of HTTP sessions that could not be established due to lack of resources on the server.
HTTP Client Aborted Before Request	All	Number of HTTP requests aborted just before sending the request on an open TCP connection.

HTTP Client Aborted After Request	All	Number of HTTP requests aborted just after sending the request on an open TCP connection.
<b>Throughput Statistics</b>		
HTTP Client Bytes Sent	All	Number of HTTP bytes transmitted by the clients. If you probe the network link with a sniffer, this statistic is not the same as the total amount of TCP payload that appears on the link. The total amount of TCP payload can be greater than this statistic (increased by retransmits) or less than this statistic (decreased by broken or reset connections). SSL-encrypted payload data is included in this statistic but SSL handshake overhead is not (HTTP only).
HTTP Client Bytes Received	All	Number of HTTP bytes received by the clients. If you probe the network link with a sniffer, this statistic is not the same as the total amount of TCP payload that appears on the link. The total amount of TCP payload can be greater than this statistic due to increases caused by retransmits. SSL-encrypted payload data is included in this statistic but SSL handshake overhead is not (HTTP only).
HTTP Client Content Bytes Sent	All	Number of bytes of HTTP data sent.
HTTP Client Content Bytes Received	All	Number of bytes of HTTP data received.
<b>Cookie Statistics</b>		
HTTP Client Cookies Received	All	Number of cookies received by the clients.
HTTP Client Cookies Sent	All	Number of cookies sent by the clients.

HTTP Client Cookies Rejected	All	Number of cookies rejected by the clients. Clients may reject cookies for the following reasons: <ul style="list-style-type: none"> <li>• Cookie jar is full</li> <li>• Path specified in the cookie is not a subset of the URI requested</li> <li>• Domain of the requesting host does not match the cookie domain</li> </ul> Cookie Reject Probability was greater than 0 and cookie was randomly selected for rejection
HTTP Client Cookies Rejected - (Path Match Failed)	All	Number of cookies rejected by the clients because the path specified in the cookie was not available on the server.
HTTP Client Cookies Rejected - (Domain Match Failed)	All	Number of cookies rejected by the clients because the cookie was sent by a server outside the domain specified in the cookie.
HTTP Client Cookies Rejected - (Cookiejar Overflow)	All	Number of cookies rejected by the clients because their cookie jars were full.
HTTP Client Cookies Rejected - (Probabalistic Reject)	All	Number of cookies rejected because the clients were configured to reject a percentage of all cookies at random.
<b>Content Encoding Statistics</b>		
HTTP Client Transfer-Encoding Received	All	Number of pages received with chunked transfer encoding.
HTTP Client Transfer-Encoding Decode Successful	All	Number of chunked transfer-encoded pages successfully decoded.
HTTP Client Transfer-Encoding Decode Failed	All	Number of chunked transfer-encoded pages that could not be decoded.

<b>Latency Statistics</b>		
HTTP Client Connect Time (us)	All	Average time elapsed between the time the client sends a SYN packet and the time it receives the SYN/ACK. Note for Tcl API users: This is a weighted statistic. If you are using this statistic in a Tcl script, use the <i>kWeightedAverage</i> aggregation type.
HTTP Client Time To First Byte (us)	All	Average time elapsed before clients received the first byte of an HTTP response. Note for Tcl API users: This is a weighted statistic. If you are using this statistic in a Tcl script, use the <i>kWeightedAverage</i> aggregation type.
HTTP Client Time To Last Byte (us)	All	Average time elapsed before clients received the last byte of an HTTP response. Note for Tcl API users: This is a weighted statistic. If you are using this statistic in a Tcl script, use the <i>kWeightedAverage</i> aggregation type.
<b>Test Objective Statistics</b>		
HTTP Client Connection Rate	All	Rate at which the client established HTTP connections.
HTTP Client Connection Attempt Rate	All	Rate at which the client attempted to establish HTTP connections.
HTTP Client Transaction Rate	All	Rate at which the client completed HTTP transactions.
HTTP Client Throughput (Kbps)	All	Rate at which the client sent and received HTTP traffic.
<b>Chunk-Transfer Encoding Statistics</b>		
<b>Note:</b> HTTP 1.0 does not support chunked-transfer encoding. If you run a test using HTTP 1.0, the chunked-transfer encoding statistics are zero.		
HTTP Client Chunk Transfer-Encoding Headers Received	All	Number of pages received with chunked transfer encoding.

HTTP Client Chunk Trans- fer-Encoding Decode Suc- cessful	All	Number of chunked transfer-encoded pages successfully decoded.
HTTP Client Chunk Trans- fer-Encoding Decode Failed	All	Total number of pages that could not be decoded.
HTTP Client Total Chunks	All	Total number of chunks recieved by the client.
Received HTTP Client Average Chunk Size	All	Average size of the chunks received.
HTTP Client Average Chunks per Response	All	Average number of chunks received for each HTTP response.
<b>Content Encoding Statistics</b> <b>Note:</b> HTTP 1.0 does not support compression (content encoding). If you run a test using HTTP 1.0, the content encoding statistics are zero.		
HTTP Client Decoded Con- tent bytes	All	Number of bytes decoded.
HTTP Client Compression Ratio	All	Average ratio of uncompressed content bytes to compressed content bytes (uncomp/comp) in compressed pages.
HTTP Client Content- Encoded Responses Received	All	Total number of encoded (compressed) pages received.
HTTP Client Gzip Content- Encoding Received	All	Number of gzip-encoded pages received.

---

HTTP Client Deflate Content-Encoding Received	All	Number of deflate-encoded pages received.
HTTP Client Unrecognized Content-Encoding Received	All	Number of pages received encoded with an unknown encoding method.
Content-Encoded Responses Decode Successful	All	Total number of pages successfully decoded.
HTTP Client Gzip Content-Encoding Decode Successful	All	Number of gzip-encoded pages successfully decoded.
HTTP Client Deflate Content-Encoding Decode Successful	All	Number of deflate-encoded pages successfully decoded.
Content-Encoded Responses Decode Failed	All	Number of deflate-encoded pages that could not be decoded for all reasons.
HTTP Client Gzip Content-Encoding Decode Failed	All	Number of gzip-encoded pages that could not be decoded for all reasons.
HTTP Client Deflate Content-Encoding Decode Failed	All	Number of deflate-encoded pages that could not be decoded for all reasons.



HTTP Client Gzip Content-Encoding Decode Failed Data Error	All	Number of gzip-encoded pages that could not be decoded because the files were corrupted.
HTTP Client Gzip Content-Encoding Decode Failed Decoding Error	All	Number of gzip-encoded pages that could not be decoded due to an internal error in IxLoad.
HTTP Client Deflate Content-Encoding Decode Failed Data Error	All	Number of deflate-encoded pages that could not be decoded because the files were corrupted.
HTTP Client Deflate Content-Encoding Decode Failed Decoding Error	All	Number of deflate-encoded pages that could not be decoded due to an internal error in IxLoad.
<b>Integrity Check Statistics</b>		
HTTP Client Content-MD5 Responses Received	All	Number of page checksums received in Content-MD5 headers.
HTTP Client Content-MD5 Check Successful	All	Number of checksums calculated by the client that matched the Content-MD5 checksums in the response headers. <b>Note:</b> Zero-byte reads do not contain any data for comparison, so they are always considered successful. Therefore, every time the client performs a read of zero bytes, this statistic is incremented.
HTTP Client Content-MD5 Check Failed	All	Number of checksums calculated by the client that did not match the Content-MD5 checksums in the response headers.
HTTP Client Custom-MD5 Responses Received	All	Number of page checksums received in Custom-MD5 (IxLoad-specific) headers.

HTTP Client Custom-MD5 Check Successful	All	Number of checksums calculated by the client that matched the Custom-MD5 checksums in the response headers. <b>Note:</b> Zero-byte reads do not contain any data for comparison, so they are always considered successful. Therefore, every time the client performs a read of zero bytes, this statistic is incremented.
HTTP Client Custom-MD5 Check Failed	All	Number of checksums calculated by the client that did not match the Content-MD5 checksums in the response headers.

### HTTP Client per-URL Statistics

The table below lists the per-URL statistics IxLoad reports for HTTP clients. Statistics in the results files and reports are averaged over all ports. If a statistic for an interval is missing, IxLoad interpolates it from the statistic immediately prior to it and the statistic after it.



**Note:** The HTTP client statistics do not include the bytes transmitted and received for the SSL handshake.

The test results are available from the location defined on the User Directories window. See User Directories.

For TCP statistics, see TCP, Run State, and Curve Segment Statistics.

Statistic	Description
<b>Transaction Statistics</b>	
HTTP Requests Sent	Number of HTTP requests sent by the clients. The statistics show the number of requests for each URL.
HTTP Requests Successful	Number of positive HTTP responses (2xx- and 3xx-range responses) received by the clients. The statistics show the number of requests for each URL.
HTTP Requests Failed	Number of HTTP requests that failed for any reason. The statistics show the number of requests for each URL (page).
HTTP Requests Failed (Write)	Number of HTTP requests that failed due to a socket write error. The statistics show the number of requests for each URL (page).

HTTP Requests Failed (Read)	Number of HTTP requests that failed due to a socket read error. The statistics show the number of requests for each URL (page).
HTTP Requests Failed (Bad Header)	Number of HTTP requests that failed due to a defective HTTP header. The statistics show the number of requests for each URL (page).
HTTP Requests Failed (4xx)	Number of 4xx-range responses received by the clients in response to an HTTP request. The statistics show the number of requests for each URL (page). 408 responses are counted separately by the HTTP Session Timeout (408) statistic and may or may not also be included in the HTTP Requests Failed (4xx) count. See the description of HTTP Session Timeout (408) for more information.
HTTP Requests Failed (400)	Bad Request. Number of requests that failed due to a syntax error in the URL. The statistics show the number of requests for each URL (page).
HTTP Requests Failed (401)	Unauthorized. Number of requests that failed due to because the server did not receive the correct user name or password from the browser. The statistics show the number of requests for each URL (page).
HTTP Requests Failed (403)	Forbidden. Number of requests that failed due to because the name or password supplied by the browser are incorrect. The statistics show the number of requests for each URL (page).
HTTP Requests Failed (404)	Not Found. Number of requests that failed because requested object is not stored on the server on the path supplied. The statistics show the number of requests for each URL (page).
HTTP Requests Failed (407)	Proxy Authentication Required. Number of requests that failed because access to the URL requires authentication with a proxy server.
HTTP Requests Failed (408)	Timeout. Number of requests that failed due to communications between the client and server taking too long. The statistics show the number of requests for each URL (page).
HTTP Requests Failed (4xx other)	Number of HTTP requests that failed for reasons other than a Bad Request (400), Unauthorized (401), Forbidden (403), Not Found (404), Proxy Authentication Required (407), or Timeout (408) error. The statistics show the number of requests for each URL (page).
HTTP Requests Failed (5xx)	Number of HTTP requests that failed due to lack of resources on the server (HTTP 500-series errors). This statistic is only incremented if the client had issued a request to the server before receiving the 5xx response. The statistics show the number of requests for each URL (page).

HTTP Requests Failed (505)	HTTP Version not Supported. Number of requests that failed because the server does not support the HTTP version used by the client. The statistics show the number of requests for each URL (page).
HTTP Requests Failed (5xx other)	Number of requests that failed for reasons other than an HTTP version mismatch (505). The statistics show the number of requests for each URL (page).
HTTP Requests Failed (Timeout)	Number of HTTP requests that failed because the clients did not receive a response within 600 seconds. The statistics show the number of requests for each URL (page).
HTTP Requests Failed (Aborted)	Number of HTTP requests that ended prematurely due to events outside HTTP or TCP. For example, if any HTTP requests are pending when the Ramp-Down period ends, those requests are aborted by IxLoad. The statistics show the number of requests for each URL (page).
HTTP Aborted Before Request	Number of HTTP requests aborted just before sending the request on an open TCP connection.
HTTP Aborted After Request	Number of HTTP requests aborted just after sending the request on an open TCP connection.
HTTP Responses Received With Match	Number of responses received that matched the Profile search string.
HTTP Responses Received Without Match	Number of responses received that did not match the Profile search string.
HTTP Intermediate Responses Received (1xx)	Number of 100-series (Informational) responses received. 100-series responses indicate a provisional response, consisting only of the Status-Line and optional headers, and terminated by an empty line. Refer to RFC 2616, Section 10, for a full description.
HTTP Requests Successful (2xx)	Number of 200-series (Successful) responses received. 200-series responses indicate that the client's request was successfully received, understood, and accepted.
HTTP Requests Successful (3xx)	Number of 300-series (Redirection) responses received. 300-series responses indicate that further action needs to be taken by the user agent in order to fulfill the request.

HTTP Requests Successful (301)	Number of 301 (Moved Permanently) responses received. 301 responses indicate that the requested resource has been assigned a new permanent URI and any future references to this resource should use one of the returned URIs.
HTTP Requests Successful (302)	Number of 302 (Found) responses received. 302 responses indicate that the requested resource resides temporarily under a different URI.
HTTP Requests Successful (303)	Number of 303 (See Other) responses received. 303 responses indicate that the response to the request can be found under a different URI and should be retrieved using a GET method on that resource.
HTTP Requests Successful (307)	Number of 307 (Temporary Redirect) responses received. 307 responses indicate that the requested resource resides temporarily under a different URI.
HTTP Content-MD5 Requests Sent	Number of requests that included Content-MD5 headers.
HTTP Requests Failed (other)	Number of requests that failed that could not be classified.
<b>Chunked-Transfer Encoding Statistics</b>	
HTTP Chunk Encoded Responses Received	Number of pages received with chunked transfer encoding.
HTTP Chunk Encoded Responses Successful	Number of chunked transfer-encoded pages successfully decoded.
HTTP Chunk Encoded Responses Failed	Number of chunked transfer-encoded pages that could not be decoded.
HTTP Total Chunks Received	Total number of chunks received by the client.
HTTP Average Chunk Size	Average size of the chunks received.

HTTP Average Chunks per Response	Average number of chunks received for each HTTP response.
<b>Decompression and Integrity Statistics</b> <b>Note:</b> HTTP 1.0 does not support compression (content encoding). If you run a test using HTTP 1.0, the content encoding statistics are zero.	
HTTP Gzip-Encoded Responses Received	Number of gzip-encoded pages received.
HTTP Gzip-Encoded Responses Successful	Number of gzip-encoded pages successfully decoded.
HTTP Gzip-Encoded Responses Failed	Number of gzip-encoded pages that could not be decoded for all reasons.
HTTP Deflate-Encoded Responses Received	Number of deflate-encoded pages received.
HTTP Deflate-Encoded Responses Successful	Number of deflate-encoded pages successfully decoded.
HTTP Deflate-Encoded Responses Failed	Number of deflate-encoded pages that could not be decoded for all reasons.
HTTP Content-MD5 Responses Received	Number of page checksums received in Content-MD5 headers.
HTTP Content-MD5 Responses Successful	Number of checksums calculated by the client that matched the Content-MD5 checksums in the response headers. <b>Note:</b> Zero-byte reads do not contain any data for comparison, so they are always considered successful. Therefore, every time the client performs a read of zero bytes, this statistic is incremented.

HTTP Content-MD5 Responses Failed	Number of checksums calculated by the client that did not match the Content-MD5 checksums in the response headers.
HTTP Custom MD5 Responses Received	Number of page checksums received in Custom-MD5 (IxLoad-specific) headers.
HTTP Custom MD5 Responses Successful	Number of checksums calculated by the client that matched the Custom-MD5 checksums in the response headers. <b>Note:</b> Zero-byte reads do not contain any data for comparison, so they are always considered successful. Therefore, every time the client performs a read of zero bytes, this statistic is incremented.
HTTP Custom MD5 Responses Failed	Number of checksums calculated by the client that did not match the Content-MD5 checksums in the response headers.
Average Compression Ratio	Average ratio of uncompressed content bytes to compressed content bytes (uncomp/comp) in compressed pages.

## TCP Reset Statistics

Under some scenarios, the number of RSTs may not match between the client and server.

For example, an Abort following a request generates two RSTs. On the client side, when the first RST is sent, the socket context is destroyed and hence only one RST is included in the client's TCP stats. However, on the server, receiving the first RST doesn't destroy the socket context immediately and so the second RST received is the one that is updated.

## IxLoad Statistics Interpolation

IxLoad statistics are interpolated. Because statistics collection points may not fall on run state-change boundaries, when the last statistics collected from the previous state and the first statistics collected from the current state are interpolated, they may not show the true condition of the current state (RU = Ramp Up, SU = Sustain, RD = Ramp Down).

For example, when the statistics from the last connection point in the SU state and the first collection point in the RD state are interpolated, they may show transactions continuing to increase, when in fact they have stopped.

The interpolated statistics for the first and second collection points within a state will show the true condition of that state. For example, when the first and second sets of statistics collected from the RD state were interpolated, they would show that transactions had stopped. See the figure below.

Figure 1: Statistics Collection and Interpolation in IxLoad

! 17



# IMAP

This section describes the IMAP Tcl API objects.

## API Overview

IMAP protocol commands are organized as shown in the figure below

An additional section, Using Auto-Generated Strings, pertains to several commands.

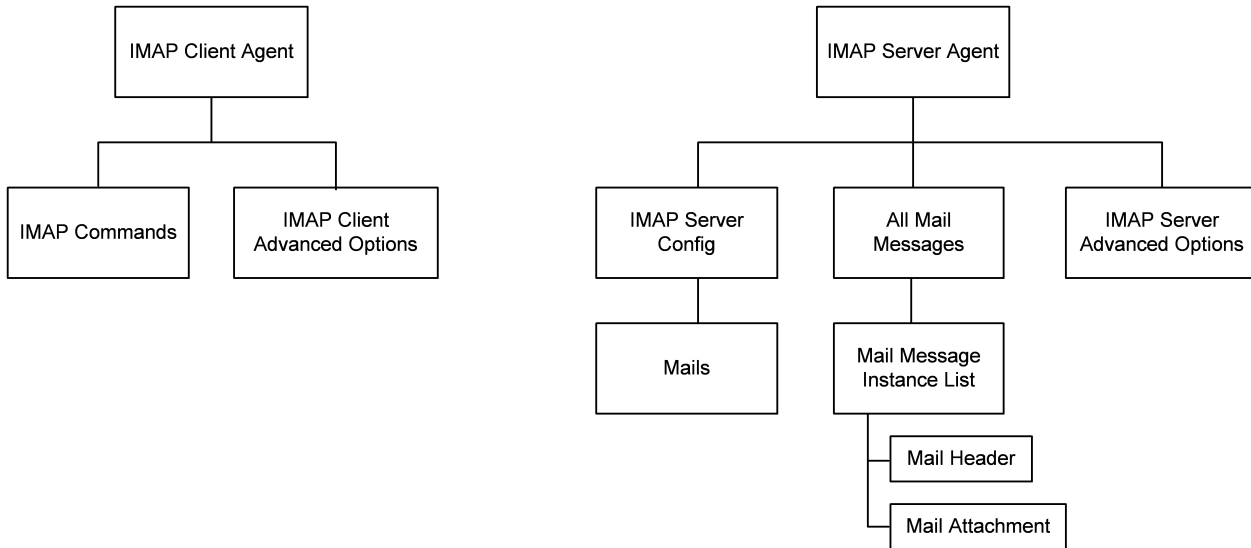

## Objectives

The objectives (userObjective) you can set for IMAP are listed below. Test objectives are set in the ixTimeline object.

- connectionRate
- transactionRate
- simulatedUsers
- concurrentConnections
- throughputMbps

- throughputKbps
- throughputGbps

## IMAP Client Agent

IMAP Client Agent - create an IMAP client

### SYNOPSIS

```
set Traffic1_Network1 [::IxLoad new ixNetTraffic]
set Activity_IMAPClient1 [$Traffic1_Network1 activityList.appendItem options...]
$Activity_IMAPClient1 agent.config
```

### DESCRIPTION

An HTTP client agent is added to the `activityList` object. The `activityList` object is added to the `ixNetTraffic` object using the `appendItem` subcommand from the `ixConfigSequenceContainer` command.

Each member of the list, however may be separately addressed and modified using the `ixConfig` subcommands.

### SUBCOMMANDS

The options for this command are configured and read using the standard `config`, `cget`, and `getOptions` subcommands defined in the `ixConfig` command.

### OPTIONS

`enable`

Enables the use of this client agent. (Default = true).

`name`

The name associated with this object, which must be set at object creation time.

### STATISTICS

### EXAMPLE

```
set Traffic1_Network1 [::IxLoad new
ixNetTraffic]##### Activity IMAPClient1
of NetTraffic Traffic1@Network1#####set
Activity_IMAPClient1 [$Traffic1_Network1 activityList.appendItem \-protocolAndType
"IMAP Client" ]##### Timeline1 for
activities IMAPClient1#####set Timeline1
[::IxLoad new ixTimeline]$Timeline1 config \-rampUpValue
1 \-rampUpType 0 \-offlineTime
0 \-rampDownTime 20 \-standbyTime
0 \-iterations 1 \-rampUpInterval
1 \-sustainTime 20 \-timelineType
0 \-name "Timeline1"$Activity_IMAPClient1 config
```

```

\enable true \-name
"IMAPClient1" \-enableConstraint false \-userObjectiveValue
100 \-constraintValue 100 \-userObjectiveType
"simulatedUsers" \-timeline $Timeline1$Activity_
IMAPClient1 agent.config \-enable true \-name
"IMAPClient1"$Activity_IMAPClient1 agent.pm.advOptions.config \-commandTimeout
120 \-vlan_priority 0 \-ipPreference
2 \-implicitLoopCheck true \-enableEsm
false \-esm 1460 \-enableVlanPriority
false$Activity_IMAPClient1 agent.pm.ipHistory.clear$Activity_IMAPClient1 agent.p-
m.imapCommands.clear$Activity_IMAPClient1 agent.pm.imapCommands.appendItem \-id
"GETMAILS" \-Username "user\[00-\]" \-Message_data_
items "(BODY.PEEK\[\\])" \-Password
"password\[00-\]" \-Mailbox_name "INBOX" \-imapServerIp
"Traffic2_IMAPServer1:143"

```

**SEE ALSO**

[ixNetTraffic](#)

## IMAP Commands

IMAP Commands—Adds an IMAP client command.

### SYNOPSIS

```
set Traffic1_Network1 [::IxLoad new ixNetTraffic]
set Activity_IMAPClient1 [$Traffic1_Network1 activityList.appendItem options...]
$Activity_IMAPClient1 agent.pm.imapCommands.appendItem
```

### DESCRIPTION

An `imapCommands` object is added to the `commandList` option of the `IMAP Client Agent` object using the `appendItem` subcommand from the `ixConfigSequenceContainer` command.

Each member of the list, however may be separately addressed and modified using the `ixConfig` subcommands.

### SUBCOMMANDS

The options for this command are configured and read using the standard `config`, `cget`, and `getOption` subcommands defined in the `ixConfig` command.

### OPTIONS

`id`

IMAP command to be executed. One of the following:

Command	Description
CAPABILITY	Requests a list of capabilities that the IMAP server supports. This command is sent to the server that the client has logged in to using a preceding OPEN command.
NOOP	Does not perform any function other than to contact the server. NOOP can be used as a periodic poll for new messages or message status updates during a period of inactivity or to reset an inactivity timer on the server.
LOGOUT	Informs the server that the client is finished using the connection. The server will send a BYE untagged response before the (tagged) OK response, and then close the network connection.
CLOSE	Permanently removes all messages that have the Deleted flag set from the currently selected mailbox, and returns to the authenticated state from the selected state. No untagged EXPUNGE responses are sent.

EXPUNGE	Permanently removes all messages that have the Deleted flag set from the currently selected mailbox. The server for each message that it removes, the server sends an untagged EXPUNGE response to the client. After it has removed all the Deleted-flagged messages, it returns an OK response.
GETMAILS	Retrieves mail messages from a server. {GetMails} is an IxLoad command that combines the functionality of multiple IMAP commands into a single command. {GetMails} performs the following IMAP commands: LOGIN SELECT UID FETCH LOGOUT
DELMAILS	Deletes all mail messages from a selected mailbox. {Delete} is an IxLoad command that combines the functionality of multiple IMAP commands into a single command. {DeleteMails} performs the following IMAP commands: UID STORE EXPUNGE
OPEN	Establishes a TCP connection to an IMAP server. OPEN is not an IMAP command.
LOGIN	Identifies the client to the server and carries the plaintext password authenticating the user.
SELECT	Selects a mailbox so that messages in it can be accessed. The IxLoad IMAP server returns a simple OK response if the mailbox name is valid.
FETCH	Retrieves data associated with a message in the mailbox. The data items to be fetched can be either a single atom or a parenthesized list.
LIST	Returns a subset of names from the complete set of all names available to the client.
STORE	Alters data associated with a message in the mailbox.
CREATE	Creates a mailbox with the given name.
THINK	The {Think} command causes the client to become inactive. {Think} is an internal IxLoad command intended to assist your testing; it is not a command defined in the IMAP protocol. If you specify identical values for the minimum and maximum times, the client will be inactive for a fixed length of time. If you specify different values for the minimum and maximum times, IxLoad will select a value within the range and cause the client to be inactive for that length of time.

DELETE	Permanently removes a mailbox with the given name. The server returns a simple OK response mail box name is RFC-compliant and the command syntax is correct. Attempting to delete the INBOX or a mailbox name that does not exist is an error.
LoopBeginCommand	An IxLoad command that you can add to the Command List to cause the commands between it and the {Loop End} to be executed a specified number of times.
LoopEndCommand	Ends the list of commands that will be executed by the preceding {Loop Begin} command.

### Arguments for id = CAPABILITY

None.

### Arguments for id = NOOP

None.

### Arguments for id = LOGOUT

None.

### Arguments for id = CLOSE

None.

### Arguments for id = EXPUNGE

None.

### Arguments for id = GETMAILS

imapServerIp

The IP address of the IMAP server, or the name of the Ixia IMAP server activity. (Default = "None").

Username

User name used to log in to the IMAP server. You can include variables (as the default value does) to generate multiple unique usernames. See [Using Auto-Generated Strings](#) on page 16-39. (Default = "user[00-]").

Password

Password used to log in to the IMAP server. You can include variables (as the default value does) to generate multiple unique passwords. See [Using Auto-Generated Strings on page 16-39](#). (Default = `"password[00-]"`).

Mailbox\_name

Mailbox to retrieve mail from. (Default = `"INBOX"`).

Message\_data\_items

Message data item names to be retrieved such as `["FLAGS","ENVELOPE"]`. (Default = `"BODY.PEEK []"`).

### Arguments for id = DELMAILS

Mailbox\_name

Mailbox to delete mail from. (Default = `"INBOX"`).

### Arguments for id = OPEN

IMAP\_Server\_IP

The IP address of the IMAP server, or the name of the Ixia IMAP server activity. (Default = `"0.0.0.0"`).

### Arguments for id = LOGIN

Username

User name used to log in to the IMAP server. You can include variables (as the default value does) to generate multiple unique user names. See [Using Auto-Generated Strings on page 16-39](#). (Default = `"user[00-]"`).

Password

Password used to log in to the IMAP server. You can include variables (as the default value does) to generate multiple unique passwords. See [Using Auto-Generated Strings on page 16-39](#). (Default = `"password[00-]"`).

### Arguments for id = SELECT

Mailbox\_name

Mailbox selected by command. (Default = `"INBOX"`).

### Arguments for id = FETCH

Message\_sequence\_set

Sequence number set specifying the messages to be retrieved. (Default = `"1-1"`).

Message\_data\_items



Message data item names to be retrieved. (Default = "FULL").

### Arguments for id = LIST

Reference\_name

Name of a mailbox or a level of mailbox hierarchy. (Default = "~").

Mail\_box\_name\_with\_wildcards

Name of the mailbox to be accessed, and wildcard characters.

The wildcard character "\*" matches zero or more characters at this position.

The wildcard character "%" is similar to "\*", but it does not match a hierarchy delimiter. If the "%" wildcard is the last character of a mailbox name argument, matching levels of hierarchy are also returned. (Default = "\*").

### Arguments for id = STORE

Message\_sequence\_set

Sequence number set specifying the messages to be retrieved. (Default = "1-1").

Data\_items

Action to be performed on message flags for the affected messages. (Default = "+FLAGS").

- **FLAGS:** Replace the flags for the message (other than \Recent) with the flag selected in the Flags parameter. The new value of the flags is returned as if a FETCH of those flags was done.
- **FLAGS.SILENT:** Equivalent to FLAGS, but without returning a new value.
- **+FLAGS:** Adds the flag selected in the Flags parameter to the message. The new value of the flags is returned as if a FETCH of those flags was done.
- **+FLAGS.SILENT:** Equivalent to +FLAGS, but without returning a new value.
- **-FLAGS:** Removes the flag selected in the Flags parameter from the message. The new value of the flags is returned as if a FETCH of those flags was done.
- **-FLAGS.SILENT:** Equivalent to -FLAGS, but without returning a new value.

Flags

Flag to be added or removed (action depends on setting of Data Items parameter) on the messages specified by Message Sequence Set parameter. (Default = "Answered").

- **Answered:** Message has been answered.
- **Flagged:** Message is marked for urgent or special attention.
- **Deleted:** Message is marked for deletion, to be removed by an EXPUNGE command at a later time.
- **Draft:** Message has not been completely composed (marked as a draft).
- **Seen:** Message has been read.

### Arguments for id = CREATE

Mailbox\_name

Creates a mailbox with the given name. Name of the mailbox to be created. You can include the server's file system hierarchy separator in the name to cause the server to create the mailbox on a directory path other than the current level. For example, if the server's hierarchy separator character is "/" and you specify "foo/bar/zap", the server should create "foo/" and "foo/bar/" if they do not already exist. (Default = "custom").

### Arguments for id = THINK

minimumInterval

Minimum length of time to sleep. Minimum = "1,000," Maximum = "2,147,483,647," (Default = "1,000").

maximumInterval

Maximum length of time to sleep. Minimum = "1,000," Maximum = "2,147,483,647," (Default = "1,000").

### Arguments for id = DELETE

Mailbox\_name

Deletes the mailbox with the given name. (Default = "custom").

### Arguments for id = LoopBeginCommand

LoopCount

Number of times to iterate. Value 0 = infinity. Minimum = "0," Maximum = "2147483647," (Default = "5").

### Arguments for id = LoopEndCommand

None.

### EXAMPLE

```
$Activity_IMAPClient1 agent.pm.imapCommands.appendItem \-id
"GETMAILS" \-Username "user\[00-\]" \-Message_data_
items "(BODY.PEEK\[ \])" \-Password
"password\[00-\]" \-Mailbox_name "INBOX" \-imapServerIp
"Traffic2_IMAPServer1:143"
```

### SEE ALSO

[IMAP Client Agent](#)

[Using Auto-Generated Strings](#)



## IMAP Client Advanced Options

IMAP Client Advanced Options - configure an IMAP client's advanced options

### SYNOPSIS

```
set Traffic1_Network1 [::IxLoad new ixNetTraffic]
set Activity_IMAPClient1 [$Traffic1_Network1 activityList.appendItem options...]
$Activity_IMAPClient1 agent.pm.advOptions.config
```

### DESCRIPTION

IMAP client advanced options are set through the `pm.advOptions` option of the `IMAP Client Agent` object (see the fexample below).

### SUBCOMMANDS

None.

### OPTIONS

`commandTimeout`

Time, in seconds, to wait for a response to an IMAP command. Minimum = 1, Maximum = 2,147,483. (Default = 12).

`enableEsm`

If `true`, the use of the `esm` option is enabled. (Default = `false`).

`esm`

If `enableEsm` is `true`, this option specifies the TCP Maximum Segment Size in the MSS (RX) field. Otherwise, the TCP Maximum Segment Size as 1,460 bytes. (Default = 1,460).

`enableVlanPriority`

VLAN Priority can be set on a per-activity basis or on a per-network (NetTraffic) basis. This parameter sets the VLAN priority for the activity. An activity's VLAN Priority bit setting takes precedence over a network's Priority bit setting. If `true`, IxLoad sets the VLAN Priority bit in traffic from this activity. Configure the VLAN priority value in `vlanPriority`. (Default = `false`).

`vlanPriority`

When `enableVlanPriority` is `true`, this option accepts the `vlan` priority value.

`ipPreference`

This option indicates the order by which the IMAP client will use the subnets, if there is a mixture of IPv4 and IPv6 subnets in the network. The values are: `IpPreferenceV4`, `IpPreferenceV6`, `IpPreferenceV4Any`, `IpPreferenceV6Any`.

`loopValue`

If this option is enabled (1), then the client progresses through the command list repeatedly until the test's sustain time. If the option is disabled (0), then the client will progress through the command list only once, and then go idle. (Default = 0).

### EXAMPLE

```
set Traffic1_Network1 [::IxLoad new
ixNetTraffic]##### Activity IMAPClient1
of NetTraffic Traffic1@Network1#####set
Activity_IMAPClient1 [$Traffic1_Network1 activityList.appendItem \-protocolAndType
"IMAP Client" ]$Activity_IMAPClient1 agent.pm.advOptions.config \-commandTimeout
120 \-vlan_priority 0 \-ipPreference
2 \-implicitLoopCheck true \-enableEsm
false \-esm 1460 \-enableVlanPriority
false
```

### SEE ALSO

[IMAP Client Agent](#)

## IMAP Server Agent

IMAP Server Agent - configure an IMAP server

### SYNOPSIS

```
set Traffic2_Network2 [::IxLoad new ixNetTraffic]
set Activity_IMAPServer1 [${Traffic2_Network2 activityList.appendItem options...}
${Activity_IMAPServer1 agent.config
```

### DESCRIPTION

An IMAP server agent is added to the `activityList` object. The `activityList` object is added to the `ixNetTraffic` object using the `appendItem` subcommand from the `ixConfigSequenceContainer` command.

Each member of the list, however may be separately addressed and modified using the `ixConfig` subcommands.

### SUBCOMMANDS

The options for this command are configured and read using the standard `config`, `cget`, and `getOption` subcommands defined in the `ixConfig` command.

### OPTIONS

`enable`

Enables the use of this action. (Default = true).

`mailConfig`

This is a list of type `IMAP Server Config`. The elements in this list are the messages that a IMAP user will receive when he queries the mailbox. (Default = {}).

`name`

The name of this server agent, which must be set at agent creation time .

### STATISTICS

### EXAMPLE

```
set Traffic2_Network2 [::IxLoad new
ixNetTraffic]##### Activity IMAPServer1
of NetTraffic Traffic2@Network2#####set
Activity_IMAPServer1 [${Traffic2_Network2 activityList.appendItem \-protocolAndType
"IMAP Server" ]set _Match_Longest_ [::IxLoad new ixMatchLongestTimeline]${Activity_
IMAPServer1 config \-enable true \-name
"IMAPServer1" \-timeline $_Match_Longest_${Activity_
```

```

IMAPServer1 agent.config \-enable true \-name
"IMAPServer1"$Activity_IMAPServer1 agent.pm.advOptions.config \-vlan_priority
0 \-esm 1460 \-enableEsm
true \-enableVlanPriority true \-listening_port
"143"$Activity_IMAPServer1 agent.pm.imapServerConfig.mails.clear$Activity_
IMAPServer1 agent.pm.imapServerConfig.mails.appendItem \-id
"mailMessageList" \-mail_name "Simple" \-mail_mesg_
count 10$Activity_IMAPServer1 agent.p-
m.allMailMessages.mailMessageInstList.clear$Activity_IMAPServer1 agent.p-
m.allMailMessages.mailMessageInstList.appendItem \-id
"mailMessage" \-mail_message_name "Simple" \-mail_format
1 \-description "100 bytes plain text body" \-custom_
mail_body_use_real_file 0 \-Answered 1 \-
Deleted 1 \-custom_mail_body_filename
"" \-mail_size 1 \-custom_mail_body_content
"" \-Flagged 1 \-cpyfrom
"Simple" \-custom_mail_body_encode 0 \-mail_size_fixed_len
100 \-Draft 1 \-Seen
1 \-mail_size_random_min_len 1 \-mail_size_random_max_len
4096 \-mail_body_type 0 \-Recent
1$Activity_IMAPServer1 agent.pm.allMailMessages.mailMessageInstList(0).-
headerList.clear$Activity_IMAPServer1 agent.pm.allMailMessages.mailMessageInstList
(0).headerList.appendItem \-id "mailHeader" \-
field_body "fromName@company.com" \-field_name
"From"$Activity_IMAPServer1 agent.pm.allMailMessages.mailMessageInstList(0).-
headerList.appendItem \-id "mailHeader" \-
field_body "fromName@company.com" \-field_name
"To"$Activity_IMAPServer1 agent.pm.allMailMessages.mailMessageInstList(0).at-
tachmentList.clear$Activity_IMAPServer1 agent.p-
m.allMailMessages.mailMessageInstList.appendItem \-id
"mailMessage" \-mail_message_name "SimpleLarge" \-mail_format
1 \-description "4k bytes plain text body" \-custom_
mail_body_use_real_file 0 \-Answered 1 \-
Deleted 1 \-custom_mail_body_filename
"" \-mail_size 1 \-custom_mail_body_content
"" \-Flagged 1 \-copyfrom
"Simple" \-custom_mail_body_encode 0 \-mail_size_fixed_len
4096 \-Draft 1 \-Seen
1 \-mail_size_random_min_len 1 \-mail_size_random_max_len
4096 \-mail_body_type 0 \-Recent
1$Activity_IMAPServer1 agent.pm.allMailMessages.mailMessageInstList(1).-
headerList.clear$Activity_IMAPServer1 agent.pm.allMailMessages.mailMessageInstList
(1).headerList.appendItem \-id "mailHeader" \-
field_body "fromName@company.com" \-field_name
"From"$Activity_IMAPServer1 agent.pm.allMailMessages.mailMessageInstList(1).-
headerList.appendItem \-id "mailHeader" \-
field_body "fromName@company.com" \-field_name

```

```
"To"$Activity_IMAPServer1 agent.pm.allMailMessages.mailMessageInstList(1).at-
attachmentList.clear$Activity_IMAPServer1 agent.pm.allMailMessages.mailMessageInstList
(4).attachmentList.appendItem \-id "mailAt-
attachment" \-attachment_data_type 1 \-number_of_attachment
"1-1" \-attach_filename "" \-attachStr
"" \-attachment_size_range "100-100" \-attachment_type
"Generated data"
```

### **SEE ALSO**

[ixNetTraffic](#)

[IMAP Server Config](#)



## IMAP Server Advanced Options

IMAP Server Advanced Options - configure an IMAP server's advanced options

### SYNOPSIS

```
set Traffic2_Network2 [::IxLoad new ixNetTraffic]
set Activity_IMAPServer1 [$Traffic2_Network2 activityList.appendItem options...]
$Activity_IMAPServer1 agent.pm.advOptions.config
```

### DESCRIPTION

IMAP client advanced options are set through the `pm.advOptions` option of the IMAP Client Agent object.

### SUBCOMMANDS

The options for this command are configured and read using the standard `config`, `cget`, and `getOption` subcommands defined in the `ixConfig` command.

### OPTIONS

`enableEsm`

If set to 1 (`true`), the use of the `esm` option is enabled. (Default = 0).

`esm`

If `enableEsm` is `true`, this option specifies the TCP Maximum Segment Size in the MSS (RX) field. Otherwise, the TCP Maximum Segment Size as 1,460 bytes. Minimum = 64, Maximum = 1,460. (Default = 1,460).

`enableVlanPriority`

VLAN Priority can be set on a per-activity basis or on a per-network (NetTraffic) basis. This parameter sets the VLAN priority for the activity. An activity's VLAN Priority bit setting takes precedence over a network's Priority bit setting. If `true`, IxLoad sets the VLAN Priority bit in traffic from this activity. Configure the VLAN priority value in `vlanPriority`. (Default = false).

`vlanPriority`

When `enableVlanPriority` is `true`, this option accepts the `vlan` priority value.

`listening_port`

Port that the IMAP server listens on. To specify multiple ports, separate the port numbers with commas (,). You can specify up to 50 listening ports. (Default = 143).

### EXAMPLE

```
$Activity_IMAPServer1 agent.pm.advOptions.config \-vlan_priority
0 \-esm 1460 \-enableEsm
true \-enableVlanPriority true \-listening_port
```

"143"

**SEE ALSO**

[IMAP Server Agent](#)

---

## IMAP Server Config

IMAP Server Config—Specifies the list of mail messages available on an IMAP server.

### SYNOPSIS

```
set Traffic2_Network2 [::IxLoad new ixNetTraffic]
set Activity_IMAPServer1 [$Traffic2_Network2 activityList.appendItem options...]
$Activity_IMAPServer1 agent.pm.imapServerConfig.mails.appendItem
```

### DESCRIPTION

IMAP Server Config defines the list of mail messages available on an IMAP server.

### SUBCOMMANDS

None.

### OPTIONS

mails

List of mail messages available on the server. This is a list of objects of type Mails. (Default = "").

### EXAMPLE

```
$Activity_IMAPServer1 agent.pm.imapServerConfig.mails.appendItem \-id
"mailMessageList" \-mail_name "Simple" \-mail_mesg_
count 10
```

### SEE ALSO

[IMAP Server Agent](#)

[Mails](#)

## Mails

Mails—Number and type of mail messages available on an IMAP server.

### SYNOPSIS

```
set Traffic2_Network2 [::IxLoad new ixNetTraffic]
set Activity_IMAPServer1 [$Traffic2_Network2 activityList.appendItem options...]
$Activity_IMAPServer1 agent.pm.imapServerConfig.mails.appendItem
```

### DESCRIPTION

Mail Message List defines a list of mail messages.

### SUBCOMMANDS

None.

### OPTIONS

mail\_name

Name of mail message type in list. See the table below for a list of the preconfigured mail messages supplied with IxLoad. (Default = "").

Message Name	Description
Simple	Plain text message, 100 bytes in size.
SimpleLarge	Plain text message, 4,096 bytes in size.
HTMLSmall	HTML-format message, 1,024 bytes in size.
HTMLRandom	HTML-format message, size varies randomly between 1,024 and 32,768 bytes.
AttachmentSmall	Plain text message 100 bytes in size, with one plain text attachof 1,024 bytes.
AttachmentLarge	HTML-format message 1,024 bytes in size, with one HTML-format attachment of 65,536 bytes.
RandomSmall	Message body that varies randomly between plain text and HTML format, varying in size between 100 and 1,024 bytes, and with from one to four plain text or HTML-format attachments. The plain text attachments range from 100 to 1,024 bytes in size, and the HTML attachments range from 512 to 4,096 bytes in size.

RandomLarge	Message body that varies randomly between plain text and HTML format, varying in size between 1,024 and 16,384 bytes, and with from one to eight plain texts or HTML-format attachments. The plain text attachments range from 1,024 to 16,384 bytes in size, and the HTML attachments range from 4,096 to 262,144 bytes in size.
-------------	---

mail\_mesg\_count

Number of mail messages of the type specified by the mail\_name option. (Default = "10").

### EXAMPLE

```
$Activity_IMAPServer1 agent.pm.imapServerConfig.mails.appendItem \-id
"mailMessageList" \-mail_name "Simple" \-mail_mesg_
count 10
```

### SEE ALSO

[IMAP Server Agent](#)

[AllMailMessages](#)

## Mail Message Instance List

Mail Message Instance List—Configures one or more mail messages.

### SYNOPSIS

```
set Traffic2_Network2 [::IxLoad new ixNetTraffic]
set Activity_IMAPServer1 [$Traffic2_Network2 activityList.appendItem options...]
$Activity_IMAPServer1 agent.pm.allMailMessages.mailMessageInstList(0).-
headerList.appendItem
```

### DESCRIPTION

Mail Message Instance List defines a list of Mail Message Instance Lists.

### SUBCOMMANDS

None.

### OPTIONS

mail\_message\_name

Name of mail message. (Default = "Simple").

description

Description of mail message. (Default = "100 byte plain text body").

cpyfrom

Existing message to be copied to create the new message. (Default = "Simple").

mail\_format

Format of the mail message. (Default = "1").

The formats available are:

Format	Description
1	Plain: The message body contains only ASCII characters and no formatting or dis-information. RFC 2822 describes this format.
2	HTML: The message body contains HTML tags for formatting and display. An HTML message is identified by the MIME type <code>text/html</code> .
3	Random: Message bodies are a random mixture of plain and HTML formats.

mail\_size

Size of the mail message in bytes. (Default = "1").

Specify the size as follows:

Size	Description
1	Fixed: The size of the message body is fixed at a single size. Use the <code>mail_size_fixed_len</code> option to specify the size.
2	Random: The size of the message body varies randomly between a minimum and a maximum size. Use the <code>mail_size_random_min_len</code> and <code>mail_size_random_max_len</code> .

`mail_size_fixed_len`

If the `mail_size` option is set to Fixed (1), this option specifies the length of the mail message, in bytes. Minimum = "1" Maximum = "2,147,483" (Default = "100").

`mail_size_random_min_len`

If the `mail_size` option is set to Random (2), this option specifies the lower bound of the range of the mail message length, in bytes. Minimum = "1" Maximum = "2,147,483" (Default = "1").

`mail_size_random_max_len`

If the `mail_size` option is set to Random (2), this option specifies the upper bound of the range of the mail message length, in bytes. Minimum = "1" Maximum = "2,147,483" (Default = "4,096").

`mail_body_type`

The mail body type can be default, imported data, or custom. You cannot import files through Tcl so you can work only with default or custom data. The value for default is 1 and custom is 2. Custom data are composed of data that you provide. If 2 is specified, then you need to specify the applicable `custom mail body options`. (Default = 1).

Recent

Flag indicating that message is new. The choices for setting this flag are:

Flag	Description
1	Always Set: Flag is always set.
2	Not Set: Flag is never set.
3	Random: Flag is randomly set.
4	Toggle: Reverses flag setting; if flag is not set, sets it; if flag is set, un-sets it.

Seen

Flag indicating that message has been read. See the description of the Recent flag for a description of the choices for setting this flag.

Answered

Flag indicating that message has been answered. See the description of the Recent flag for a description of the choices for setting this flag.

Deleted

Flag indicating that message has been deleted. See the description of the Recent flag for a description of the choices for setting this flag.

Draft

Flag indicating that message has not been completed. See the description of the Recent flag for a description of the choices for setting this flag.

custom\_mail\_body\_use\_real\_file

This option accepts boolean value of 0 or 1. If zero is given, there is no need to specify a file name. You have to enter the mail message text in custom\_mail\_body\_content. If 1 is given, a file name is specified in the custom\_mail\_body\_filename.

custom\_mail\_body\_encode

This option specifies the encoding option for the real file. For boolean value 0, IxLoad encodes the file using the default encoding. For already encoded files, you choose boolean value 1.

custom\_mail\_body\_filename

This option specifies the absolute path for the real file. See the following example: "c:\temp.txt" \

custom\_mail\_body\_content

This option accepts the mail message text. Example: "abcd123."

headerList

List of Header List objects included with message.

attachmentList

List of Attachment List objects included with message.

**EXAMPLE**

```
$Activity_IMAPServer1 agent.pm.allMailMessages.mailMessageInstList.appendItem \-id
"mailMessage" \-mail_message_name "Simple" \-mail_format
1 \-description "100 bytes plain text body" \-custom_
mail_body_use_real_file 0 \-Answered 1 \-
Deleted 1 \-custom_mail_body_filename
"" \-mail_size 1 \-custom_mail_body_content
"" \-Flagged 1 \-cpyfrom
"Simple" \-custom_mail_body_encode 0 \-mail_size_fixed_len
```



```
100 \-Draft
1 \-mail_size_random_min_len
4096 \-mail_body_type
1
```

```
1 \-Seen
1 \-mail_size_random_max_len
0 \-Recent
```

**SEE ALSO**

[IMAP Server Agent](#)

## All Mail Messages

All Mail Messages—A list of Mail Message Instance Lists.

### SYNOPSIS

```
set Traffic2_Network2 [::IxLoad new ixNetTraffic]
set Activity_IMAPServer1 [$Traffic2_Network2 activityList.appendItem options...]
$Activity_IMAPServer1 agent.pm.allMailMessages.mailMessageInstList(0).-
headerList.appendItem
```

### DESCRIPTION

All Mail Messages defines a list of Mail Message Instance Lists.

### SUBCOMMANDS

None.

### OPTIONS

mailMessageInstList

Mail Message Instance List. (Default = "").

### EXAMPLE

```
$Activity_IMAPServer1 agent.pm.allMailMessages.mailMessageInstList.appendItem \-id
"mailMessage" \-mail_message_name "Simple" \-mail_format
1 \-description "100 bytes plain text body" \-custom_
mail_body_use_real_file 0 \-Answered 1 \-
Deleted 1 \-custom_mail_body_filename
"" \-mail_size 1 \-custom_mail_body_content
"" \-Flagged 1 \-cpyfrom
"Simple" \-custom_mail_body_encode 0 \-mail_size_fixed_len
100 \-Draft 1 \-Seen
1 \-mail_size_random_min_len 1 \-mail_size_random_max_len
4096 \-mail_body_type 0 \-Recent
1
```

### SEE ALSO

[IMAP Server Agent](#)

[Mail Message Instance List](#)

## Using Auto-Generated Strings

In some of the fields in the IMAP client and server Activities, you can include variables that will cause IxLoad to automatically generate multiple values for the field. For example, the IMAP Username and Password fields both support the inclusion of variables.

See Using Automatic Sequence Generators.

## IMAP Statistics

The test results are available from the location defined on the User Directories window. See User Directories.

For IMAP client statistics, see [IMAP Client statistics](#) .

For IMAP server statistics, see [IMAP Server Statistics](#).

For TCP statistics, see TCP, Run State, and Curve Segment Statistics.

## IMAP Client Statistics

The table below lists the statistics that IxLoad reports for IMAP clients.

Statistic	Description
IMAP Sessions Requested	Number IMAP sessions requested by the client. This statistic is the total of: IMAP Sessions Established + IMAP Sessions Failed. An IxLoad IMAP "session" is the sequence of client/server interactions that take place from the time that a TCP connection is established until it is terminated.
IMAP Sessions Established	Number of IMAP sessions successfully established by the client (the client received an 'OK' response from the server).
IMAP Sessions Failed	Number of IMAP sessions that the client was unable to establish (the client did not receive an 'OK' response from the server).
IMAP Total Bytes Sent	Total number of bytes sent by the client in IMAP commands, responses, and messages. This statistic counts all the bytes in the IMAP packet including the terminating CRLF.
IMAP Total Bytes Received	Total number of bytes received by the client in IMAP commands, responses, and messages. This statistic counts all the bytes in the IMAP packet including the terminating CRLF.
IMAP Mail Bytes Received	Total number of bytes contained in the mail messages retrieved by the client.
IMAP Total Mails Received	Total number of mail messages retrieved by the client.
IMAP Commands Timeout	Total number of IMAP commands for which the client did not receive a response within the timeout period.
IMAP capability Command Sent	Total number of CAPABILITY commands sent by the client.
IMAP noop Command Sent	Total number of NOOP commands sent by the client.
IMAP login Command Sent	Total number of LOGIN commands sent by the client.
IMAP logout Command Sent	Total number of LOGOUT commands sent by the client.

---

IMAP list Command Sent	Total number of LIST commands sent by the client.
IMAP select Command Sent	Total number of SELECT commands sent by the client.
IMAP fetch Command Sent	Total number of FETCH commands sent by the client.
IMAP store Command Sent	Total number of STORE commands sent by the client.
MAP create Command Sent	Total number of CREATE commands sent by the client.
IMAP delete Command Sent	Total number of DELETE commands sent by the client.
IMAP close Command Sent	Total number of CLOSE commands sent by the client.
IMAP expunge Command Sent	Total number of EXPUNGE commands sent by the client.
MAP uid fetch Command Sent	Total number of UID FETCH commands sent by the client.
IMAP uid store Command Sent	Total number of UID STORE commands sent by the client.
IMAP capability Command Failed	Total number of CAPABILITY commands sent by the client that failed for any reason.
IMAP noop Command Failed	Total number of NOOP commands sent by the client that failed for any reason.
IMAP login Command Failed	Total number of LOGIN commands sent by the client that failed for any reason.
IMAP logout Command Failed	Total number of LOGOUT commands sent by the client that failed for any reason.
IMAP list Command Failed	Total number of LIST commands sent by the client that failed for any reason.

IMAP select Command Failed	Total number of SELECT commands sent by the client that failed for any reason.
IMAP fetch Command Failed	Total number of FETCH commands sent by the client that failed for any reason.
IMAP store Command Failed	Total number of STORE commands sent by the client that failed for any reason.
IMAP create Command Failed	Total number of CREATE commands sent by the client that failed for any reason.
IMAP delete Command Failed	Total number of DELETE commands sent by the client that failed for any reason.
IMAP close Command Failed	Total number of CLOSE commands sent by the client that failed for any reason.
IMAP expunge Command Failed	Total number of EXPUNGE commands sent by the client that failed for any reason.
IMAP uid fetch Command Failed	Total number of UID FETCH commands sent by the client that failed for any reason.
IMAP uid store Command Failed	Total number of UID STORE commands sent by the client that failed for any reason.
IMAP capability Command OK	Total number of CAPABILITY commands for which the client received an OK response.
IMAP noop Command OK	Total number of NOOP commands for which the client received an OK response.
IMAP login Command OK	Total number of LOGIN commands for which the client received an OK response.
IMAP logout Command OK	Total number of LOGOUT commands for which the client received an OK response.
IMAP list Command OK	Total number of LIST commands for which the client received an OK response.

IMAP select Command OK	Total number of SELECT commands for which the client received an OK response.
IMAP fetch Command OK	Total number of FETCH commands for which the client received an OK response.
IMAP store Command OK	Total number of STORE commands for which the client received an OK response.
IMAP create Command OK	Total number of CREATE commands for which the client received an OK response.
IMAP delete Command OK	Total number of DELETE commands for which the client received an OK response.
IMAP close Command OK	Total number of CLOSE commands for which the client received an OK response.
IMAP expunge Command OK	Total number of EXPUNGE commands for which the client received an OK response.
IMAP uid fetch Command OK	Total number of UID FETCH commands for which the client received an OK response.
IMAP uid store Command OK	Total number of UID STORE commands for which the client received an OK response.
IMAP Total Bytes Sent and Received	Combined total of all bytes transmitted and received by the client in IMAP commands, responses, mail messages, and attachments
IMAP Transaction Rate	Rate at which the client completed IMAP transactions.
IMAP Transactions	Total number of IMAP transactions of all types.
IMAP Connection Rate	Rate at which the client established IMAP connections.
IMAP Connections	Total number of IMAP connections established.
IMAP Total Connections	Total number of IMAP connections of established. "Connection" refers to the entire sequence of client/server interactions from the initial establishment of the connection to the server until its termination.



---

IMAP Concurrent Connection	Number of concurrent IMAP connections active.
IMAP Simulated Users	Number of IMAP users simulated by the client.

## IMAP Server Statistics

The table below lists the statistics that IxLoad reports for IMAP servers.

Statistic	Description
IMAP Session Requests Received	Number of requests to establish IMAP sessions received by the server. "Session" refers to the sequence of client/server interactions from the time that a TCP connection is established until the time that TCP connection terminates.
IMAP Session Requests Completed	Number of requested IMAP sessions successfully established by the server.
IMAP Session Requests Failed	Number of requested IMAP sessions that the server failed to establish.
IMAP Total Mail Bytes Sent	Total number of bytes sent by the server in IMAP responses and messages. This statistic counts all the bytes in the IMAP packet including the terminating CRLF.
IMAP Total Mails Sent	Total number of mail messages sent over IMAP connections.
IMAP Total Attachments Sent	Total number of attachments sent over IMAP connections.
IMAP Total Mails with Attachments Sent	Total number of mail messages sent that included one or more attachments.
IMAP Total Bytes Sent	Total number of bytes sent by the server in IMAP commands, responses, and messages.
IMAP Total Bytes Received	Total number of bytes received by the server in IMAP commands, responses, and messages.
IMAP Total Bytes Sent and Received	Combined total of all bytes transmitted and received by the server in IMAP commands, responses, and mail messages.
IMAP capability Command Received	Total number of CAPABILITY commands received by the server.
IMAP noop Command Received	Total number of NOOP commands received by the server.

IMAP login Command Received	Total number of LOGIN commands received by the server.
IMAP logout Command Received	Total number of LOGOUT commands received by the server.
IMAP list Command Received	Total number of LIST commands received by the server.
IMAP select Command Received	Total number of SELECT commands received by the server.
IMAP fetch Command Received	Total number of FETCH commands received by the server.
IMAP store Command Received	Total number of STORE commands received by the server.
IMAP create Command Received	Total number of CREATE commands received by the server.
IMAP delete Command Received	Total number of DELETE commands received by the server.
IMAP close Command Received	Total number of CLOSE commands received by the server.
IMAP expunge Command Received	Total number of EXPUNGE commands received by the server.
IMAP uid_fetch Command Received	Total number of UID FETCH commands received by the server.
IMAP uid_store Command Received	Total number of UID STORE commands received by the server.
IMAP capability Response Sent	Total number of CAPABILITY responses sent by the server.
IMAP noop Response Sent	Total number of NOOP responses sent by the server.
IMAP login Response Sent	Total number of LOGIN responses sent by the server.

IMAP logout Response Sent	Total number of LOGOUT responses sent by the server.
IMAP list Response Sent	Total number of LIST responses sent by the server.
IMAP select Response Sent	Total number of SELECT responses sent by the server.
IMAP fetch Response Sent	Total number of FETCH responses sent by the server.
IMAP store Response Sent	Total number of STORE responses sent by the server.
IMAP create Response Sent	Total number of CREATE responses sent by the server.
IMAP delete Response Sent	Total number of DELETE responses sent by the server.
IMAP close Response Sent	Total number of CLOSE responses sent by the server.
IMAP expunge Response Sent	Total number of EXPUNGE responses sent by the server.
IMAP uid_fetch Response Sent	Total number of UID FETCH responses sent by the server.
IMAP uid_store Response Sent	Total number of UID STORE responses sent by the server.
IMAP capability Sent Failed	Total number of CAPABILITY responses that the server failed to send.
IMAP noop Sent Failed	Total number of NOOP responses that the server failed to send.
IMAP login Sent Failed	Total number of LOGIN responses that the server failed to send.
IMAP logout Sent Failed	Total number of LOGOUT responses that the server failed to send.
IMAP list Sent Failed	Total number of LIST responses that the server failed to send.

---

IMAP select Sent Failed	Total number of SELECT responses that the server failed to send.
IMAP fetch Sent Failed	Total number of FETCH responses that the server failed to send.
IMAP store Sent Failed	Total number of STORE responses that the server failed to send.
IMAP create Sent Failed	Total number of CREATE responses that the server failed to send.
IMAP delete Sent Failed	Total number of DELETE responses that the server failed to send.
IMAP close Sent Failed	Total number of CLOSE responses that the server failed to send.
IMAP expunge Sent Failed	Total number of EXPUNGE responses that the server failed to send.
IMAP uid_fetch Sent Failed	Total number of UID FETCH responses that the server failed to send.
IMAP uid_store Sent Failed	Total number of UID STORE responses that the server failed to send.

! 18

This page intentionally left blank.

## IPTV/ Video

This section describes the IPTV/Video Tcl API objects.

### Overview

This section describes the IPTV / Video commands.

### Video

The IxLoad video API consists of a client agent, a server agent, and their com



**Note:** Do not run video tests from the `../3rdParty/Tcl8.4.7/bin` directory. During Download-on-Demand (DOD), a `.tgz` file is created which uses a python tarfile which in turn uses `zlib.dll`. The `../3rdParty/Tcl8.4.7/bin` directory contains a local `zlib.dll` inside which confuses the DOD process.

## IPTV

The IPTV client and server API structure is similar to the video API structure with some additions.

### IPTV Mode Server and Client

The IxLoad Video client and server can operate in either of two modes:

Video to emulate a standard multicast/unicast video client and server. The option for Video is 0.

IPTV to emulate an IPTV client and server. The option for IPTV is 1. For exam

```
$Activity_IPTV_VideoServer1 agent.pm.videoConfig.config \-serverMode
```

```
1
```

## Video Server

In the IPTV mode, the IxLoad video server can be configured to emulate two types of IPTV servers: a combination A/D Server or a V server.

- In an actual IPTV implementation an **A** (Acquisition) server packages RTP streams into multicast UDP packets and streams them onto the distribution network.
- A **D** (Distribution) server caches a certain amount of the multicast video data being streamed over the network. When a user changes a channel, the D server sends a short unicast burst of the new channel's video traffic for the user to view while the system switches the user from the previous channel's multicast group to the new channel's group.
- A **V** server provides Video-on-Demand service to an IPTV client.

This is explained in the `type` option in `Video Properties and Stream`.

## Video Client

In IPTV mode, the IxLoad video client emulates an IPTV client. In IPTV mode, all the same commands are available as in Video mode, except that the `Join` command is replaced with the `ICCCCommand` for testing multicast performance. This is explained in the `Commands` section.

## IPTV Options

The IPTV Options configure the options specific to the video client in IPTV mode. Refer `IPTV Options` for detailed information.

## Objectives

The objectives (userObjective) you can set for Video are listed below. Test objectives are set in the `ixTimeline` object.

- `simulatedUsers`
- `streams`
- `connectionRate`
- `transactionRate`

## Video Client API Structure

The figure below shows the structure of the video client API.



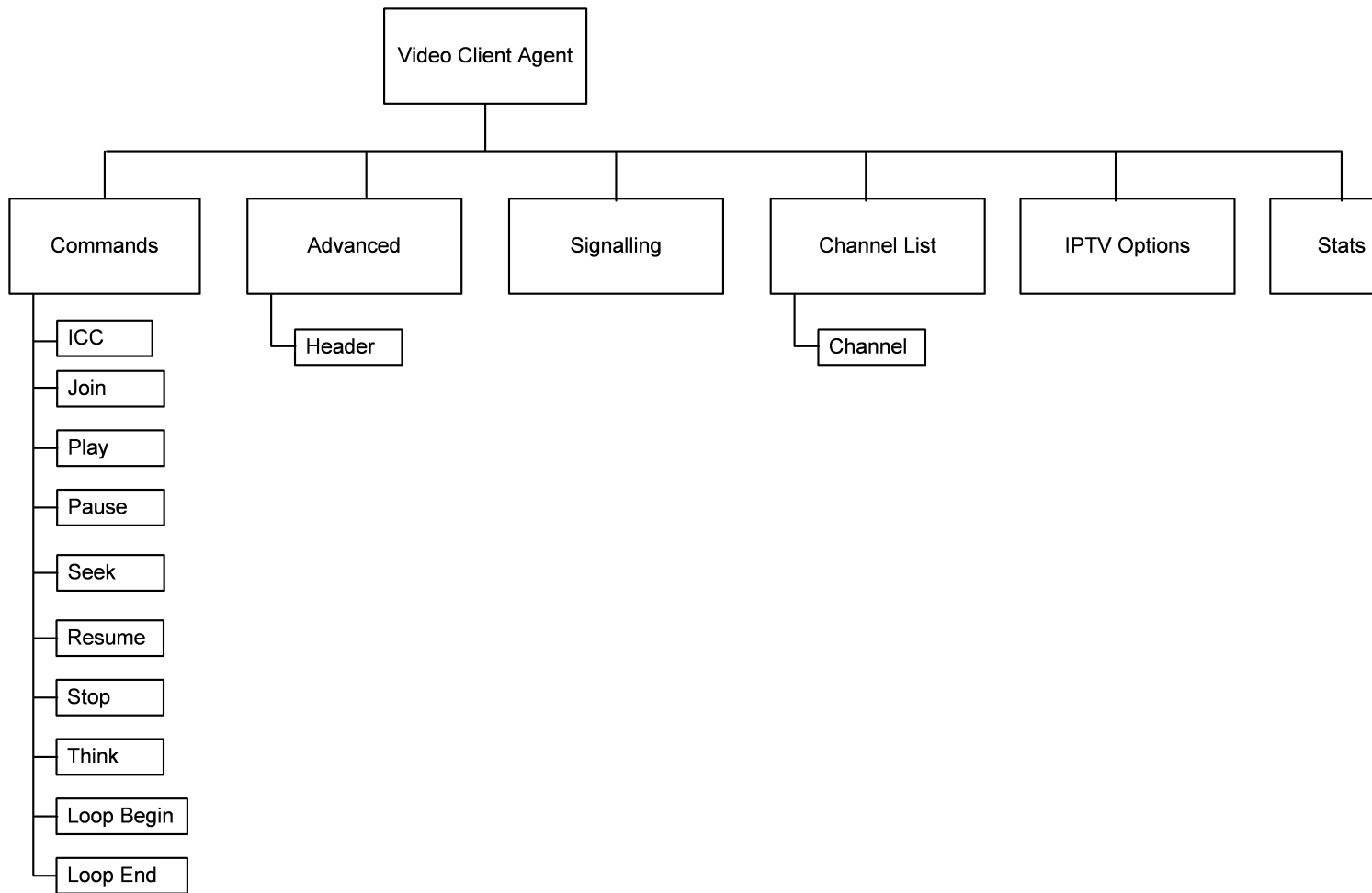

## Video Client Agent

Video Client Agent - configure an IPTV or video client

### SYNOPSIS

```
set Traffic1_Network1 [::IxLoad new ixNetTraffic]
set Activity_IPTV_VideoClient1 [$Traffic1_Network1 activityList.appendItem
option...]
$Activity_IPTV_VideoClient1 agent.config
```

### DESCRIPTION

The Video Client Agent command defines a simulated user viewing video clips from a video-on-demand (VOD) server or real-time streaming video from a broadcast-type video source. A video client agent is added to the `activityList` object. The `activityList` object is added to the `ixNetTraffic` object using the `appen` subcommand from the `ixConfigSequenceContainer` command.

Each member of the list, however may be separately addressed and modified using the `ixConfig` subcommands.

### SUBCOMMANDS

The options for this command are configured and read using the standard `config`, `cget`, and `getOptions` subcommands defined in the `ixConfig` command.

### OPTIONS

`enable`

Enables the use of this client agent. (Default = true).

`loopValue`

If this option is enabled (1), then the client progresses through the command list repeatedly until the test's sustain time. If the option is disabled (0), then the client will progress through the command list only once, and then go idle. (Default = 0).

`name`

The name associated with this object, which must be set at object creation time.

## STATISTICS



**Note:** For some of the per-stream and Video Quality monitoring statistics in the GUI, various scaling factors are applied to make the values easier to read. When you retrieve these statistics from the Tcl API, the values returned may be different from those shown in the GUI. The following statistics are affected:

- MDI-DF, MDI-DF-AVG, MDI-DF-MIN, and MDI-DF-MAX are in nanosec(ns) when retrieved from the Tcl API. In the GUI, they are displayed in milliseconds (ms).
- Stream Bit Rate is returned in bits per second (bps) when retrieved from the Tcl API. In the GUI, it is displayed in kilobits per second (kbps).
- When retrieved from the Tcl API, MOS\_V, Degradation (Loss), Degradation (Discard), and Degradation (Video Codec) are scaled up by 256 compared to GUI. For example, the MOS score is displayed on a 0 - 5 scale in the GUI but is returned as a value in the range 0 - 1280 when retrieved from the Tcl API. The Degradation statistics are displayed in the GUI as a percentage. When retrieving them from the Tcl API, divide the returned value by 256 to get the percentage.
- When retrieved from the Tcl API, VSTQ is scaled by 2 compared to the value in the GUI. Divide the returned value by 2 to get the actual value.

## EXAMPLE

```
set Traffic1_Network1 [::IxLoad new
ixNetTraffic]##### Activity IPTV_
VideoClient1 of NetTraffic
Traffic1@Network1#####set Activity_IPTV_
VideoClient1 [$Traffic1_Network1 activityList.appendItem \-protocolAndType
"Video Client" ]##### Timeline1 for
activities IPTV_VideoClient1#####set
Timeline1 [::IxLoad new ixTimeline]$Timeline1 config \-rampUpValue
1 \-rampUpType 0 \-offlineTime
0 \-rampDownTime 20 \-standbyTime
0 \-iterations 1 \-rampUpInterval
1 \-sustainTime 20 \-timelineType
0 \-name "Timeline1"$Activity_IPTV_VideoClient1
config \-enable true \-name
"IPTV_VideoClient1" \-enableConstraint false \-
userObjectiveValue 100 \-constraintValue
100 \-userObjectiveType "simulatedUsers" \-timeline
$Timeline1$Activity_IPTV_VideoClient1 agent.config \-enable
true \-name "IPTV_VideoClient1"$Activity_IPTV_
VideoClient1 agent.pm.signalling.config \-general_query_response_mode
true \-unsolicited_response_mode false \-report_frequency
60 \-igmp_version "IGMP v3" \-mld_version
"MLD v2" \-router_alert true \-group_specific_query_
response_mode true \-enable_custom false \-suppress_
```

```

reports                                true \-ip_version                                "IPv4"
\-\-immediate_response                  false \-\-client_mode
0$Activity_IPTV_VideoClient1 agent.pm.signalling.profile_table.clear$Activity_IPTV_
VideoClient1 agent.pm.signalling.profile_table.appendItem \-id
"ProfileTable" \-\-name                                "Fast Switching" \-\-num_
profiles                                1 \-\-channel_switch_delay_max                0 \-\-
duration_max                            30 \-\-duration_min
10 \-\-percentage                                50.0 \-\-channel_switch_delay_min
0$Activity_IPTV_VideoClient1 agent.pm.signalling.profile_table.appendItem \-id
"ProfileTable" \-\-name                                "Slow Switching" \-\-num_
profiles                                1 \-\-channel_switch_delay_max                0 \-\-
duration_max                            300 \-\-duration_min
100 \-\-percentage                                50.0 \-\-channel_switch_delay_min
0$Activity_IPTV_VideoClient1 agent.pm.stats.config \-\-MinDelay
20 \-\-MaxDelay                                80 \-\-enableFrameStats
false \-\-qualityLimit                            0 \-\-IgnoreLoss
false \-\-frameLimit                            0 \-\-JBEMode
0 \-\-enableVQmonStats                            false \-\-totalLimit
0 \-\-updateInterval                            2000 \-\-NomDelay
20 \-\-bitrateLimit                                0$Activity_IPTV_VideoClient1 agent.p-
m.iptv_options.config \-\-iptv_switch_delay                1 \-\-iptv_switch_mode
0$Activity_IPTV_VideoClient1 agent.pm.advanced.config \-\-vlan_priority
0 \-\-type_of_service_for_rtsp                    "Best Effort (0x0)" \-\-rtsp_header
"Real Player" \-\-enableTosRTSP                            false \-\-implicitLoopCheck
true \-\-enableEsm                                    false \-\-users_allowed
1 \-\-esm                                            1460 \-\-enableVlanPriority
false \-\-transport                                1$Activity_IPTV_VideoClient1 agent.p-
m.advanced.header_values.clear$Activity_IPTV_VideoClient1 agent.pm.advanced.header_
values.appendItem \-id                                "Header" \-\-name
"User-Agent" \-\-value                                "RealMedia Player
(HelixDNAclient)"$Activity_IPTV_VideoClient1 agent.pm.ipHistory.clear$Activity_IPTV_
VideoClient1 agent.pm.channelSrcHistory.clear$Activity_IPTV_VideoClient1 agent.p-
m.channelSrcHistory.appendItem \-id                                "chan-
nelSrc" \-\-name                                "ANY"$Activity_IPTV_VideoClient1
agent.pm.UrlHistory.clear$Activity_IPTV_VideoClient1 agent.pm.predefined_
tos.clear$Activity_IPTV_VideoClient1 agent.pm.predefined_tos.appendItem \-id
"TypeOfService" \-\-tos_val                            "Best Effort (0x0)"$Activ-
ity_IPTV_VideoClient1 agent.pm.predefined_tos.appendItem \-id
"TypeOfService" \-\-tos_val                            "Class 1 (0x20)"$Activity_
IPTV_VideoClient1 agent.pm.predefined_tos.appendItem \-id
"TypeOfService" \-\-tos_val                            "Class 2 (0x40)"$Activity_
IPTV_VideoClient1 agent.pm.predefined_tos.appendItem \-id
"TypeOfService" \-\-tos_val                            "Class 3 (0x60)"$Activity_
IPTV_VideoClient1 agent.pm.predefined_tos.appendItem \-id
"TypeOfService" \-\-tos_val                            "Class 4 (0x80)"$Activity_
IPTV_VideoClient1 agent.pm.predefined_tos.appendItem \-id
"TypeOfService" \-\-tos_val                            "Express Forwarding

```

```

(0xA0)"$Activity_IPTV_VideoClient1 agent.pm.predefined_tos.appendItem \-id
"TypeOfService" \-tos_val "Control (0xC0)"$Activity_
IPTV_VideoClient1 agent.pm.commands.clear$Activity_IPTV_VideoClient1 agent.p-
m.commands.appendItem \-id "JoinCommand" \-des-
tination_server_activity "Traffic2_IPTV_VideoServer1:0" \-group_address_
step "0.0.0.1" \-channel_switch_mode "Con-
current" \-start_group_address_sym "" \-sigma
1 \-start_group_address "" \-channel_switch_delay_max
0 \-mu 1 \-varLambda
1 \-duration_max 10 \-duration_min
10 \-watch_count 1 \-group_address_count
1 \-source_address "ANY" \-concurrent_channels
1 \-channel_switch_delay_min 0

```

**SEE ALSO**[ixNetTraffic](#)

## Commands

Commands—Creates the list of Video commands that the client will send to a Video server.

### SYNOPSIS

```
set Traffic1_Network1 [::IxLoad new ixNetTraffic]
set Activity_IPTV_VideoClient1 [$Traffic1_Network1 activityList.appendItem
option...]
$Activity_IPTV_VideoClient1 agent.pm.commands.appendItem
```

### DESCRIPTION

A command is added to the `Commands` object using the `appendItem` subcommand from the `ixConfigSequenceContainer` command.

### SUBCOMMANDS

The options for this command are configured and read using the standard `config`, `cget`, and `getOption` subcommands defined in the `ixConfig` command.

### OPTIONS

`id`

Video command to be executed. One of the following:

Command	Description
ICCCommand	The Instant Channel Change (ICCCommand) plays IPTV streams for a fixed duration and then switches to new streams.
JoinCommand	The JOIN command sends an IGMP JOIN message to one or more IGMP servers in order to play their broadcast channels. The client can join multiple multicast groups in sequence or at random intervals. After joining a multicast group, the client plays each channel for a specific duration. After the duration has expired, the client sends the IGMP LEAVE command for that channel. The client plays all the channels specified in the JOIN command, then it moves on to the next command in the command list. Once the test enters the rampdown phase, the client does not join any new channels.
PlayCommand	The PLAY command plays the VoD video stream from a video server. The PLAY command performs the following RTSP commands in order: DESCRIBE SETUP PLAY

PlayMediaCommand	<p>The PLAYMEDIA command supports symbolic destination for Video Server in Video Client. The <code>Media / URL</code> in PLAY command and <code>start_group_address</code> for JOIN command are resources that get populated when the server activity is selected.</p> <p>The server activity can be <code>None</code>, when IxLoad video client is run against an external video server. The PLAYMEDIA command performs the following RTSP commands, in order:</p> <pre>DESCRIBE SETUP PLAY</pre>
PlayStaticCommand	<p>PlayStatic command plays a video stream whose description is sourced from the PlayStatic command itself. PlayStatic is intended for use with RTSP servers that do not implement the RTSP Describe command, which is normally the source of a video stream's description.</p>
KeepAliveCommand	<p>KeepAliveCommand periodically sends an empty RTSP GET_PARAMETER command to the server so that the server does not assume that the client is inactive and then tears down the connection.</p> <p>Although you can add a KeepAliveCommand to any position in a command list, IxLoad will only send a KeepAliveCommand if a stream has been setup and is active. Typically, KeepAliveCommnds should only be added after PLAY, PAUSE and similar commands. KeepAliveCommand can only be used for VoD (unicast) streams.</p>
PauseCommand	<p>The PAUSE command sends an RTSP PAUSE command to pause playback of the current VoD video stream. To resume playback, use the RESUME command.</p>
SeekCommand	<p>The SEEK command jumps to a location in the media stream and plays from that location. The SEEK command must be preceded by a PAUSE command.</p> <p>The IxLoad video server only supports the SEEK command for transport streams (MPEG-2 TS files). It does not support the SEEK command for MPEG-4, H.264, or VC1 streams.</p>
ResumeCommand	<p>The RESUME command sends an RTSP PLAY command to resume playback of a paused VoD video stream.</p>
StopCommand	<p>The STOP command sends an RTSP STOP command to stop playback of the current VoD video stream.</p>
ThinkCommand	<p>The {THINK} command causes the client to become inactive.</p>

PassiveCommand	<p>The PassiveCommand passively monitors unicast or multicast audio and video streams and records statistics for them.</p> <p>When used in conjunction with an AFM module, this command enables you to use the AFM module as a tap, and gather statistics such as MDI or video quality metrics at various points within a network. Statistics are recorded both globally and on a per-stream basis. Quality metrics are recorded for both video and audio streams.</p>
LoopBeginCommand	<p>The {Loop Begin} command is an IxLoad command that you can add to the Command List to cause the commands between it and the {Loop End} to be executed a specified number of times.</p>
LoopEndCommand	<p>{Loop End} ends the list of commands that will be executed by the preceding {Loop Begin} command.</p>
RTSP Commands	<p>In addition to the high-level commands that simplify testing video, the IxLoad IPTV/Video client also allows you to configure and send individual RTSP commands. This enables you to test video using low-level RTSP commands, and take advantage of the quality metrics other statistics that are available in the IxLoad IPTV/Video client.</p>
DescribeCommand	<p>Retrieves the description of a presentation or media object identified by the URL in the <code>media</code> option. The server responds with a description of the requested resource.</p>
RTSPSetupCommand	<p>Specifies the transport mechanism to be used for the streamed media. A client can issue a SETUP request for a stream that is already playing to change transport parameters, if the server allows it. Specify the transport mechanism in the <code>arguments</code> option.</p>
RTSPPlayCommand	<p>Tells the server to start playback using the mechanism specified by a previous SETUP command. Specify the stream in the <code>media</code> option, and the playback duration in the <code>arguments</code> option.</p>
RTSPPauseCommand	<p>Causes the stream playback to be temporarily halted. If you specify a stream in the <code>media</code> option, only playback of that stream is halted. If you do not specify a stream, all streams are paused.</p>
RTSPSetParamCommand	<p>This method requests to set the value of a parameter for a stream specified by the URL. Specify the name of this parameter in the <code>arg</code> option. IxLoad Video Server does not support RTSP SET_PARAMETER command.</p>



RTSPGetParamCommand	Retrieves the current value of a parameter from the server. If you issue the GET_PARAMETER with no arguments, it functions as a keep-alive to prevent the server from closing the connection when long presentations are playing. IxLoad Video Server does not support RTSP GET_PARAMETER command.
RTSPTeardownCommand	Stops the stream delivery for the URL listed in the media option, freeing the resources associated with it. After issuing the TEARDOWN command, the RTSP session identifier associated with the session is no longer valid.

### Arguments for id = ICCCommand (IPTV mode only)

The Instant Channel Change (ICC) command plays IPTV streams for a fixed duration and then switches to new streams. You can only use the ICC command in Activities running over IPv4 networks.

`destination_server_activity`

Video server hosting the media that the client will play.

- IxLoad server: If you are using an IxLoad video server, specify the server address.
- External server: If you are using an external video server, specify None.

Default = None.

`group_address_step`

Specifies the amount of increase in the channel number (A server address). See the description of the `group_address_count` for more information.

`channel_switch_mode`

Specifies the order in which the client joins the multicast groups in the Channel List to view the channels.

`sequential`: The client plays the channels in the Channel List one after the other, in order based on their address, starting with the `start_group_address`. After the Channel Watch Duration expires, the client sends an IGMP LEAVE for the channel being viewed. The client waits for the duration specified by Channel Switch Delay duration before joining the next group to view the next channel.

`poisson`: The client plays the channel in an order that follows a Poisson distribution. Configure the `watch_count`, then set the `varLambda` value for the Poisson distribution.

`normal`: The client plays the channel in an order that follows a Normal distribution. Configure the `watch_count`, then set the `mu` and `sigma` values for the Normal distribution.

`unique`: Each user starts from a different channel, and plays each channel in numerical order. There are no configuration options for a Unique sequence. The number of channels played is automatically set to the same value as the Count parameter.

`custom`: The client plays the channels following an existing profile, but in a sequence that you specify.

Default = "sequential".

`start_group_address_sym`

The address of the video server hosting the media that the client will play.

`sigma`

In a Normal distribution,  $m$  ( $\mu$ ) is the location parameter and  $s$  ( $\sigma$ ) is the scale parameter. In `IxLoad`,  $\mu$  is the mean average channel number that the distribution will be clustered around. As channel numbers increase or decrease away from the  $\mu$  value, they are less likely to be watched.  $\sigma$  determines the width of the distribution, the number of channels that may be watched.

`start_group_address`

Specifies the first group address.

`channel_switch_delay_max`

If you want the client to pause before switching to the next channel, specify the maximum length of the delay here.

`da_switchover_delay`

If you want the client to pause before switching to the next channel, specify the length of the delay here. You can specify a fixed-length delay (same delay before playing every channel) or a random-length delay (different delay before playing every channel).

`serverIP`

IP address of the D server.

`mu`

In a Normal distribution,  $m$  ( $\mu$ ) is the location parameter and  $s$  ( $\sigma$ ) is the scale parameter. In `IxLoad`,  $\mu$  is the mean average channel number that the distribution will be clustered around. As channel numbers increase or decrease away from the  $\mu$  value, they are less likely to be watched.  $\sigma$  determines the width of the distribution, the number of channels that may be watched.

`varLambda`

A Poisson distribution models the number of events that occur within a given time interval. In a Poisson distribution,  $\lambda$  ( $\lambda$ ) is the shape parameter, which indicates the average number of events in the given time interval. When used for `IxLoad`, the  $\lambda$  value is the mean average channel number that the distribution will be clustered around. The bell-curved shape of the distribution ensures that the most-watched channels will be those closest to the mean (the  $\lambda$ ), with channels less likely to be watched as channel numbers move away from the  $\lambda$  value.

`urls`

IPTV (multicast) streams to play from the D server.

You can enter sequence generators in this field to generate URLs for more than one stream.

The number of D server URLs must match the A server Channel Count.

`duration_max`

Maximum length of time, in seconds, that users of this profile will view a channel. Minimum = "1," Maximum = "2,147,483." (Default = "10").

duration\_min

Minimum length of time, in seconds, that users of this profile will view a channel. Minimum = "1," Maximum = "2,147,483." (Default = "10").

watch\_count

Number of channels that will be viewed as a part of this Join command.

If you set the channel\_switch\_mode to Normal or Poisson, you can configure the value here. For the other distribution options, this option is read-only and automatically set to the same value as the Channel Count parameter.

group\_address\_count

Specifies the number of additional channels, if you want the client to play more than one channel (stream).

source\_address

Configures the source address (the IP address of the A server), if the client uses IGMP v3 and you want to send a source-specific JOIN to a multicast group.

If you specify ANY, the client does not specify a particular source address.

Default = "ANY".

concurrent\_channels

Specifies the number of channels that each client plays at one time. You can specify up to four channels to play at one time.

Default = 1.

channel\_switch\_delay\_min

If you want the client to pause before switching to the next channel, specify the minimum length of the delay here.

### Arguments for id = JoinCommand

start\_group\_address

IP address of the first multicast group that the client will join.

group\_address\_count

Number of multicast groups that the client will join. Minimum = "1," Maximum = "1,000." (Default = "1").

group\_address\_step

If the client will join more than one multicast group, enter the amount of increase in the multicast group address. Minimum = "1." (Default = "1").

source\_address

If the client uses IGMP v3 and you want the JOIN request to specify a source for the video stream, configure the source address in this field. If you specify ANY, the client does not specify a particular source address. (Default = "ANY")

duration\_max

Maximum length of time, in seconds, that users of this profile will view a channel. Minimum = "1," Maximum = "2,147,483." (Default = "10").

duration\_min

Minimum length of time, in seconds, that users of this profile will view a channel. Minimum = "1," Maximum = "2,147,483." (Default = "10").

concurrent\_channels

If channel\_switch\_mode is set to Concurrent, this parameter specifies the number of channels that the client plays at one time. Minimum = "1," Maximum = "5." (Default = "1").

channel\_switch\_mode

Order in which the client joins the multicast groups in the Channel List to play the channels. The choices are:

Mode	Description
sequential	The client plays the channels in the Channel List one after the other, in order based on their address, starting with the Starting Group Address. After the Channel Watch Duration expires, the client sends an IGMP LEAVE for the channel being watched. The client waits for the duration specified by Channel Switch Delay duration before joining the next group to play the next channel.
random	The client plays the channels in the Channel List randomly.
concurrent	(default) The client plays the channels in the Channel List in order, based on their address. Specify the number of channels that it can play at any one time in the Concurrent Channels field.
poisson	The client plays the channel in an order that follows a Poisson distribution. For Poisson distribution, the channel_switch_mode is set to "Poisson". New attributes used are: watch_count and varLambda.
normal	The client plays the channel in an order that follows a Normal distribution. For Normal distribution, the channel_switch_mode is set to "Normal" New attributes used are: mu, sigma and watch_count.

unique	Each user starts from a different channel, and plays each channel in numerical order. There are no configuration options for a Unique sequence. The number of channels played is automatically set to the same value as the Count parameter.
custom	The client plays the channels following an existing profile, but in a sequence that you specify.

`channel_switch_delay_min`

Minimum length of the time, in milliseconds, that the client will pause before playing the next channel on the server. Minimum = "0," Maximum = "2,147,483,647." (Default = "0").

`channel_switch_delay_max`

Maximum length of the time, in milliseconds, that the client will pause before playing the next channel on the server. Minimum = "0," Maximum = "2,147,483,647." (Default = "0").

### Arguments for id = PlayCommand

`serverIP`

Video server that hosts the video stream to be played.

`media`

Video stream to be played. You can include sequence generators in this field to automatically generate unique requests from simulated users. For information on how to use sequence generators, see the section on Using Automatic Sequence Generators. For example:

```
-media "Stream\[1-\]"
```

`duration_max`

Maximum length of time, in seconds, that users of this profile will view a channel. Minimum = "1," Maximum = "2,147,483." (Default = "10").

`duration_min`

Minimum length of time, in seconds, that users of this profile will view a channel. Minimum = "1," Maximum = "2,147,483." (Default = "10").

### Arguments for id = PlayMediaCommand

`symServerIP`

Video server that hosts the video stream to be played.

`media`

Video stream to be played. You can include sequence generators in this field to automatically generate unique requests from simulated users. For information on how to use sequence generators, see the section on Using Automatic Sequence Generators. For example:

```
-media "Stream\[1-\]"
```

duration

Length of time (in seconds) to play the video stream. Minimum = "1," Maximum = "2,147,483."  
(Default = "1").

### Arguments for id = PlayStaticCommand

symServerIP

Video server that hosts the video stream to be played.

media

Video stream to be played. You can include sequence generators in this field to automatically generate unique requests from simulated users. For information on how to use sequence generators, see the section on Using Automatic Sequence Generators.

duration

Length of time (in seconds) to play the video stream. Minimum = "1," Maximum = "2,147,483."  
(Default = "1").

destination\_server\_activity

Represents the symbolic destination of the server.

serverIP

Video server that hosts the video stream to be played.

### Arguments for id = PlayMediaStaticCommand

cmdName

Name of the command added to the command list. Default = "PlayMediaStaticCommand *n*" where *n* is the command's position in the command list.

commandType

Command type. Default = "PlayMediaStaticCommand"

symServerIP

Video server that hosts the video stream to be played. Default = "None".

media

Video stream to be played. You can include sequence generators in this field to automatically generate unique requests from simulated users. For information on how to use sequence generators, see the section on Using Automatic Sequence Generators.

duration\_max

Maximum length of time (in seconds) to play the video stream. Minimum = "1," Maximum = "2,147,483." (Default = "1").

duration\_min

Minimum length of time (in seconds) to play the video stream. Minimum = "1," Maximum = "2,147,483."  
(Default = "1").

seekTo

Reserved. Default = -1

serverIP

Video server that hosts the video stream to be played. This can be an IP address or a symbolic destination (IxLoad server). Default = ""(none)

### Arguments for id = KeepAliveCommand

count

Number of {KeepAlive} messages to be sent.

min\_freq

The minimum time, in milliseconds, that can elapse before the client sends the next {KeepAlive} message.

max\_freq

The maximum time, in milliseconds, that can elapse before the client sends the next {KeepAlive} message.

### Arguments for id = PauseCommand

None.

### Arguments for id = SeekCommand

duration\_max

Maximum length of time, in seconds, that users of this profile will view a channel. Minimum = "1," Maximum = "2,147,483." (Default = "10").

duration\_min

Minimum length of time, in seconds, that users of this profile will view a channel. Minimum = "1," Maximum = "2,147,483." (Default = "10").

### Arguments for id = ResumeCommand

seekTo

Number of seconds, measured from the start of the stream, to jump to and start playing from. Minimum = "1," Maximum = "2,147,483." (Default = "1").

duration\_max

Maximum length of time, in seconds, that users of this profile will view a channel. Minimum = "1," Maximum = "2,147,483." (Default = "10").

duration\_min

Minimum length of time, in seconds, that users of this profile will view a channel. Minimum = "1," Maximum = "2,147,483." (Default = "10").

### Arguments for id = StopCommand

None.

### Arguments for id = ThinkCommand

minimumInterval

Minimum length of the time, in milliseconds, that the client will pause before playing the next channel on the server. Minimum = "1,000," Maximum = "2,147,483,647." (Default = "1,000").

maximumInterval

Maximum length of the time, in milliseconds, that the client will pause before playing the next channel on the server. Minimum = "1000," Maximum = "2,147,483,647." (Default = "1,000").

### Arguments for id = PassiveCommand

enableUnicast

Enables an Unicast or Multicast stream that can be monitored. (Default = "0"). If you enter 1 that is Unicast, then a new rule needs to be configured. The rule is explained below.

#### Configuring Rule for Stream

```
$Activity_IPTV_VideoClient1 agent.pm.commands(0).rule.appendItem\  
-id "Rule" \  
-clock_rate 90000 \  
-codec "H264" \  
-value "10000-65535" \  
-rtpt 96
```

id

The name of the rule.

clock\_rate

Specifies the stream's bit rate. (Default = "90000").

codec

Indicates the codec used on the stream. (Default = "H264").



value

Indicates the port range used by the stream. (Default = "10000-65535").

rtp\_pt

Sets the RTP Payload type to a default value based on the `codec` value. The values are:

Codec	Default RTP Payload Type value
MPEG-TS	33
H264	96 (Default)
MPEG4 Part 2	97
VC1	98

### Arguments for id = LoopBeginCommand

LoopCount

Number of times to iterate. Value '0' treated as infinity. Minimum = "0," Maxi= "2,147,483,647."  
(Default = "5").

### Arguments for id = LoopEndCommand

None.

### Arguments for id = DescribeCommand

destination\_server\_activity

The Video server that the client will send the media URL described in `media`. The media URL identifies the set of stream to be controlled. Specify the destination as follows:

- If the destination is a real RTSP server, enter the server's host name or IP address. By default, the request will be sent to port 554. If the server is listening on a different port, specify the port number after the host name or IP address as follows: `server:port`.
- If the destination is an IxLoad RTSP server Activity, select the Activity.

(Default = "None").

serverIP

The IP address of the server.

media

The presentation URL sent to the server. The presentation URL identifies the stream to be controlled. Media names may only contain letters, numbers, and the special symbols `\:', '\;', '\_', '\/'` and `\-`.

(Default = "None").

### Arguments for id = RTSPPlayCommand

duration\_max

Maximum length of time, in seconds, that users of this profile will view a channel.

duration\_min

Minimum length of time, in seconds, that users of this profile will view a channel.

### Arguments for id = RTSPSetParamCommand

content

Specifies the value of the content.

contentType

Specifies the parameter of the content.

### Arguments for id = RTSPGetParamCommand

content

Specifies the value of the content.

contentType

Specifies the parameter of the content.

### EXAMPLE

```
$Activity_IPTV_VideoClient1 agent.pm.commands.appendItem \-id
"JoinCommand" \-destination_server_activity "Traffic2_IPTV_VideoServer-
1:0" \-group_address_step "0.0.0.1" \-channel_switch_mode
"Concurrent" \-start_group_address_sym "" \-sigma
1 \-start_group_address "" \-channel_switch_delay_max
0 \-mu 1 \-varLambda
1 \-duration_max 10 \-duration_min
10 \-watch_count 1 \-group_address_count
1 \-source_address "ANY" \-concurrent_channels
1 \-channel_switch_delay_min 0$Activity_IPTV_VideoClient1 agent.p-
m.commands.appendItem \-id "PassiveCommand" \-
enableUnicast 0$Activity_IPTV_VideoClient1 agent.p-
m.commands.appendItem \-id "DescribeCommand" \-
destination_server_activity "Traffic2_IPTV_VideoServer1:554" \-serverIP
"198.18.0.101" \-media "Stream0"$Activity_IPTV_
VideoClient1 agent.pm.commands.appendItem \-id
"RTSPSetupCommand"$Activity_IPTV_VideoClient1 agent.pm.commands.appendItem \-id
"RTSPPlayCommand" \-duration 20 \-seekTo
-1$Activity_IPTV_VideoClient1 agent.pm.commands.appendItem \-id
"RTSPTeardownCommand"
```

**SEE ALSO**

[Video Client Agent](#)

## Advanced

Advanced—Sets the Video client agent's global configuration options for unicast traffic.

### SYNOPSIS

```
set Traffic1_Network1 [::IxLoad new ixNetTraffic]
set Activity_IPTV_VideoClient1 [$Traffic1_Network1 activityList.appendItem
option...]
$Activity_IPTV_VideoClient1 agent.pm.advanced.config
```

### DESCRIPTION

A Video client's advanced configuration options are set by modifying the options of the `pm.advanced` option of the `Video Client Agent` object using its `appendItem`.

### SUBCOMMANDS

None.

### OPTIONS

`enableEsm`

If `true`, the use of the `esm` option is enabled. (Default = `false`).

`esm`

If `enableEsm` is `true`, this option specifies the TCP Maximum Segment Size in the MSS (TX) field. Otherwise, the TCP Maximum Segment Size is 1,460 bytes. (Default = 1,460).

`transport`

Transport protocol used to send the video stream. It applies only to VoD.

Value	Description
0	RTP over UDP
1	(default) UDP

`enableTosRTSP`

Enables the setting of the TOS (Type of Service) bits in the IP header of the RTSP packets.

Value	Description
0	(default) TOS bits not enabled.
1	TOS bits enabled.

`type_of_service_for_rtsp`

If `enableTosRTSP` is `true`, this option specifies the IP Precedence / TOS (Type of Service) bit setting and Assured Forwarding classes. (Default = "Best Effort 0x0"). If you want to specify the standard choices that are in the GUI, you can use a string representation. To specify any of the other 255 TOS values, specify the decimal value. The default choices are:

Value	Description
"Best Effort (0x0)"	(Default) routine priority
"Class 1 (0x20)"	Priority service, Assured Forwarding class 1
"Class 2 (0x40)"	Immediate service, Assured Forwarding class 2
"Class 3 (0x60)"	Flash, Assured Forwarding class 3
"Class 4 (0x80)"	Flash-override, Assured Forwarding class 4
"Express Forwarding (0xA0)"	Critical-ecp
"Control (0xC0)"	Internet-control

`rtsp_header`

Type of header used to identify the video player simulated by the Video client agent. The choices are:

Value	Description
Windows Media Player	Windows Media Player 9.0
Real Player	(default) Real Networks RealPlayer
Quick Time	Apple Quick Time 6.5
Custom	Custom player. Use the options to configure the headers that will identify this client.

`header_values`

List of headers included with RTSP requests that the client sends to the server. sent to the `If rtsp_header` is set to `Custom`, use this option to define the capabilities of the custom video client. This list is of type `Header`; items are added to the list via the `appendItem` subcommand. Each element of the list must be of the form "name: value" without any spaces in the key. (Default = None).

`disableStreamStats`

Disables collection of stream-related statistics to reduce memory usage. Values = 1 (True), 0 = False (Default).

`max_tracks_per_stream`

Maximum number of tracks (RTP streams) that the client should expect in each RTSP stream. Values = Min="1", Max="500", Default="2".

`enableVlanPriority`

VLAN Priority can be set on a per-activity basis or on a per-network (NetTraffic) basis. This parameter sets the VLAN priority for the activity. An activity's VLAN Priority bit setting takes precedence over a network's Priority bit setting. If `true`, IxLoad sets the VLAN Priority bit in traffic from this activity. Configure the VLAN priority value in `vlanPriority`. (Default = `false`).

`vlanPriority`

When `enableVlanPriority` is `true`, this option accepts the `vlan` priority value.

`enableCustomSetup`

This enables or disables the entry of parameters specified in the `Transport:` line of the RTSP SETUP message. You can use these parameters to set or enable additional RTSP transport options on the server. Default = `false`.

`customSetup`

If `enableCustomSETUPtransportParam` is `false`, then the `Transport:` line contains the following data, which is mandatory for RTSP:

Transport protocol, connection type (unicast or multicast), and client IP port range used for the transport protocol. For example:

```
RTP/AVP;unicast;client_port=35246-35247
```

If `enableCustomSETUPtransportParam` is `true`, then IxLoad appends a semi-colon (;) to the mandatory data on `Transport:` line, and then appends the custom data in the field.

For example, if you specify the string `mode=PLAY`, the `Transport:` line will contain the following string:

```
RTP/AVP;unicast;client_port=35246-35247;mode=PLAYenable_custom_protocol
```

If `true`, a user-defined name is used to identify a protocol instead of the default. Specify the name using the `custom_protocol_name` option. Default = `false`.

`custom_protocol_name`

If `enable_custom_protocol` is `true`, this option is the name used to identify a protocol instead of the standard name. Default = "MP2T".

`enable_custom_profile`

If `true`, a user-defined name is used to identify a profile instead of the default. Specify the name using the `custom_profile_name` option. Default = `false`.

`custom_profile_name`

If `enable_custom_profile` is `true`, this option is the name used to identify an A/V sync profile instead of the standard name. Default = "H2221".

`rtspProxyEnable`

Enables use of an RTSP proxy.

rtspProxyIp

If `enableRtspProxy` is true, specify the RTSP proxy IP address.

rtspProxyPort

If `enableRtspProxy` is true, specify the RTSP proxy port number.

followRtspRedirects

If enabled, the client follows RTSP redirect responses from the server. Default = false.

rtcp\_enable

If True, the RTCP port number is included in the SDP description. Values = 1 (True), 0 (False (default)).

enable\_async\_tearardown

If True, playback is stopped when the client receives a request header that contains a specific text sub-string. Values = 1 (True), 0 (False (default)).

async\_tearardown\_hdr\_val

If `enable_async_tearardown` is True, this option specifies the header sub-string that will stop playback. Default = "".

enable\_graceful\_rampdown

If True, the test is stopped by moving to the Ramp-down phase and sessions are torn down gracefully. If False, traffic is stopped as soon as possible, which may leave sessions up on the DUT. Default = "false".

enable\_hwacc

If True, hardware acceleration is used. Default = "false".

## EXAMPLE

```
$Activity_IPTV_VideoClient1 agent.pm.advanced.config \-followRtspRedirect
true \-vlan_priority 0 \-type_of_service_for_rtsp
"Best Effort (0x0)" \-rtsp_header "Real Player" \-
enableTosRTSP false \-implicitLoopCheck
true \-rtspProxyEnable true \-CustomSetup
"mode=PLAY" \-enableCustomSetup true \-enableEsm
false \-users_allowed 1 \-rtspProxyIp
"0.0.0.0" \-rtspProxyPort "554" \-esm
1460 \-enableVlanPriority false \-transport
1
```

**SEE ALSO**

[Video Client Agent](#)

[Header](#)



## Header

Header—Creates a list of RTSP headers to define a Video client as a custom video player.

### SYNOPSIS

```
set Traffic1_Network1 [::IxLoad new ixNetTraffic]
set Activity_IPTV_VideoClient1 [$Traffic1_Network1 activityList.appendItem
option...]
$Activity_IPTV_VideoClient1 agent.pm.advanced.header_values.appendItem
```

### DESCRIPTION

If the Advanced option `rtsp_header` is set to `Custom`, use `Header` to create the name = value pairs that will form the header that the Video client agent sends to the server.

### SUBCOMMANDS

The options for this command are configured and read using the standard `config`, `cget`, and `getOption` subcommands defined in the `ixConfig` command.

### OPTIONS

name

Name of the header. RFC 2326 defines the RTSP headers. (Default = "").

value

Value for header. (Default = "").

### EXAMPLE

```
$Activity_IPTV_VideoClient1 agent.pm.advanced.header_values.appendItem
-name "Cache-Control" \
-value "no-cache"
```

### SEE ALSO

[Advanced](#)

## Signaling

Signaling—Configures the multicast signaling options.

### SYNOPSIS

```
set Traffic1_Network1 [::IxLoad new ixNetTraffic]
set Activity_IPTV_VideoClient1 [$Traffic1_Network1 activityList.appendItem
option...]
$Activity_IPTV_VideoClient1 agent.pm.signalling.config
```

### DESCRIPTION

A Video client's Signaling options are set by modifying the options of the `pm.Signalling.config` option of the `Video Client Agent` object.

### SUBCOMMANDS

None.

### OPTIONS

`enable_custom`

If enabled, the custom client profiles that have been configured will be used in a test. The `duration` and `channel_switch_mode` configured for individual JOIN commands (Arguments for `id = JoinCommand` on page 18-35) will not apply. (Default = "0").

`igmp_version`

Sets the version of IGMP used by the client. The choices are:

Value	Description
"IGMPv1"	IGMP version 1. <b>Note:</b> IGMP v1 requires IPv4 (see the <code>ip_version</code> option)
"IGMPv2"	IGMP version 2.
"IGMPv3"	(default) IGMP version 3.

`ip_version`

Sets the IP version used for multicast addresses. If multicast addresses are in IPv4 format, and you can select the `igmp_version`. If multicast addresses are in IPv6 format, and you can select the `mld_version`.

`general_query_response_mode`

If `true`, the video client responds to General Query messages.

Value	Description
0	Client does not respond to General Query messages.
1	(default) Client responds to General Query messages.

`unsolicited_response_mode`

If `true`, the video client automatically sends full IGMP membership messages at regular intervals without waiting for a query message. In the Report Interval Field, specify the frequency, in seconds, at which unsolicited messages are generated.

Value	Description
0	(default) Client does not send unsolicited IGMP membership messages.
1	Client sends unsolicited IGMP membership messages.

`immediate_response`

If `true`, the video client will ignore the value specified in the Maximum Response Delay in the Membership Query message, assume that the Delay is always zero (0) seconds, and immediately respond to the Query by sending a Report.

Value	Description
0	(default) Client does not immediately respond to a query with a report.
1	Client immediately responds to a query with a report.

`group_specific_query_response_mode`

If enabled, the client responds to group-specific Query messages. A group-speQuery message is sent by a multicast router so it can learn about the multireception state of one multicast address, for each of the neighboring interfaces, for example, when a member leaves a group.

Value	Description
0	(default) Client does not respond to group-specific queries.
1	Client responds to group-specific queries.

`mld_version`

Version of the Multicast Listener Discovery (MLD) protocol used to listen for IPv6 multicast addresses. You can select MLDv1 or MLDv2.

The `ip_version` has to be "IPv6" for MLD.

`suppress_reports`

(IGMPv3 only) If `true`, the client allows its IGMPv3 Membership Record to be "suppressed" by a membership report for version 2. The suppression will only be for group reports received from another port.

Value	Description
0	Client does not allow its membership record to be suppressed.
1	(default) Client allows its membership record to be suppressed.

`report_frequency`

If `unsolicited_response_mode` is `true`, this option specifies the frequency (in seconds) at which unsolicited messages are generated. (Default = "30").

`parallel_multicast_vod`

If `true`, simulated users can watch a VoD stream and one or more multicast streams simultaneously. Values = 1 (True), 0 (False, default)

`client_mode`

Specifies whether the client is a video client (0) or IPTV client (1). Default = 0.

**EXAMPLE**

```
$Activity_IPTV_VideoClient1 agent.pm.signalling.config \-general_query_response_mode
true \-unsolicited_response_mode                false \-report_frequency
60 \-igmp_version                                "IGMP v3" \-mld_version
"MLD v2" \-router_alert                          true \-group_specific_query_
response_mode      true \-enable_custom          false \-suppress_
reports            true \-ip_version              "IPv4"
\-immediate_response      false \-client_mode
0
```

**SEE ALSO**

[Video Client Agent](#)

## Profiles

Profiles—Determines the channel switching behavior of the video client.

### SYNOPSIS

```
set Traffic1_Network1 [::IxLoad new ixNetTraffic]
set Activity_IPTV_VideoClient1 [$Traffic1_Network1 activityList.appendItem
option...]
$Activity_IPTV_VideoClient1 agent.pm.signalling.profile_table.appendItem
```

### DESCRIPTION

If custom profiles is enabled, the channel watch `duration` (the length of time a channel is viewed) and the `channel_switch_mode` (how quickly the simulated user switches from to a different channel) for all the users' JOIN commands are controlled by the profiles.

A Video client's Profile table is set by modifying the options of the `pm.Signaling` option of the `Video Client Agent` object using the `appendItem` command.

### OPTIONS

`name`

This is the name of the profile table.

If enabled, the custom client profiles that have been configured will be used in a test. The `duration` and `channel_switch_mode` configured for individual JOIN commands (`Arguments for id = JoinCommand` on page 18-35) will not apply. (Default = "0").

`num_profiles`

This indicates the number of profiles to be added with the same parameters.

`percentage`

Percentage of video clients that the profile will be applied to. The percentages of all profiles must add up to 100.

The profile table is populated by default with a couple of profiles. If you want to declare a custom profile, you need to clear the table with the following command:

```
$clnt_traffic agentList(0).pm.signalling.profile_table.clear
```

If you do not clear the table before you start adding profiles, you will get an exception saying you have too many profiles which add up to over 100%.

`duration_min`

Minimum length of time, in seconds, that users of this profile will view a channel (play a file). Minimum = "1," Maximum = "2,147,483." (Default = "1").

`duration_max`

Maximum length of time, in seconds, that users of this profile will view a chan(play a file). Minimum = "1," Maximum = "2,147,483." (Default = "1").

channel\_switch\_delay\_min

Minimum length of time, in milliseconds, that users of this profile will pause before viewing a new channel (requesting a new file). Minimum = "0," Maximum = "2,147,483,647." (Default = "0").

channel\_switch\_delay\_max

Maximum length of time, in milliseconds, that users of this profile will pause before viewing a new channel (requesting a new file). Minimum = "0," Maximum = "2,147,483,647." (Default = "0").

### EXAMPLE

```
$Activity_IPTV_VideoClient1 agent.pm.signalling.profile_table.appendItem \-id
"ProfileTable" \-name "Fast Switching" \-num_
profiles 1 \-channel_switch_delay_max 0 \-
duration_max 30 \-duration_min
10 \-percentage 50.0 \-channel_switch_delay_min
0$Activity_IPTV_VideoClient1 agent.pm.signalling.profile_table.appendItem \-id
"ProfileTable" \-name "Slow Switching" \-num_
profiles 1 \-channel_switch_delay_max 0 \-
duration_max 300 \-duration_min
100 \-percentage 50.0 \-channel_switch_delay_min
0
```

### SEE ALSO

[Video Client Agent](#)

[Signaling](#)

## Channel View

Channel View Table—Describes the channel view configuration options.

### DESCRIPTION

Describes the options that are specific to the channel view table in custom option for channel\_switch\_ mode for IPTV and multicast.

### SYNOPSIS

```
set Activity_IPTV_VideoClient1 [$Traffic1_Network1 activityList.appendItem]
$Activity_IPTV_VideoClient1 agent.pm.commands(0).channelviewTable.appendItem
```

### Options

view\_sequence

Mentions the sequence in which the channel is viewed.

view\_sequence

Indicates the name of the channel view table.

### EXAMPLE

```
$Activity_IPTV_VideoClient1 agent.pm.commands(0).channelviewTable.appendItem \-id
"ChannelViewTable" \-view_sequence "0-8,9" \-name
"Fast Switching"$Activity_IPTV_VideoClient1 agent.pm.commands(0).chan-
nelviewTable.appendItem \-id "ChannelViewTable"
\ -view_sequence "0-8,9" \-name
"Slow Switching"
```

## IPTV Options

IPTV Options—Describes the options that are specific to the video client in IPTV mode.

### SYNOPSIS

```
set Activity_IPTV_VideoClient1 [$Traffic1_Network1 activityList.appendItem
$Activity_IPTV_VideoClient1 agent.pm.iptv_options.config
```

### DESCRIPTION

Describes the options that are specific to the video client in IPTV mode. IPTV Options are configured with the `agent.pm.iptv_options.config` option of activity list of the Video Client Agent.

### Options

`iptv_switch_delay`

If `iptv_switch_mode` is "2" then specify the fixed length of time here. minimum = "1", maximum = "60", default = "1".

`iptv_switch_mode`

Selects how the IPTV client switches from the D server stream to the A server stream. The choices are:

Value	Description
"0" (Default)	Stop receiving D server stream when first A server packet is received
"1"	Receive D server stream for its entire duration
"2"	Stop receiving D server streams after receiving A server stream for certain duration

### EXAMPLE

```
set Activity_IPTV_VideoClient1 [$Traffic1_Network1 activityList.appendItem$Activity_
IPTV_VideoClient1 agent.pm.iptv_options.config \-iptv_switch_delay
1 \-iptv_switch_mode                2
```



## Stats

Stats—Configures the statistics that IxLoad gathers for the client's video streams.

### DESCRIPTION

Stats are configured with the `agent.pm.stats.config` option of activity list of the Video Client Agent.

### SYNOPSIS

```
set Traffic1_Network1 [::IxLoad new ixNetTraffic]
set Activity_IPTV_VideoClient1 [$Traffic1_Network1 activityList.appendItem
options...]
$Activity_IPTV_VideoClient1 agent.pm.stats.config
```

### Options

`PerStreamEntriesPerUser`

Number of streams displayed for each user in the per-Stream view of the statistics. Default = "4", Min = "1", Max = "4".

`updateInterval`

Frequency, in milliseconds, at which IxLoad gathers the Quality Metrics statistics. Default="2000", Min = "2000", Max = "100000".

`nominalDelay`

Length of time that packets are held in playout buffer before being played. Default="2", Min = "1", Max = "100000".

`bufferSize`

Maximum number of packets that can be stored in the playout buffer at any instance in time. Default="65535", Min = "1", Max = "65535".

`enableVuserMonitor`

Enables monitoring of a virtual user. Default = false.

`vuserId`

ID of the virtual user that you want to monitor. Min="1" Max="2147483647" Default="1".

`enableVQmonStats`

If enabled, IxLoad applies the values in the Quality Metrics fields to the video streams received by the client and computes the Quality Metrics statistics.

`updateInterval`

Frequency, in milliseconds, at which IxLoad gathers the statistics related to the quality metrics.  
Default="2000", Min = "2000", Max = "100000".

MinDelay

This parameter is no longer used in IxLoad 4.20 and subsequent releases.

MaxDelay

This parameter is no longer used in IxLoad 4.20 and subsequent releases.

enableFrameStats

This parameter is no longer used in IxLoad 4.20 and subsequent releases.

NomDelay

This parameter is no longer used in IxLoad 4.20 and subsequent releases.

IgnoreLoss

This parameter is no longer used in IxLoad 4.20 and subsequent releases.

JBEMode

This parameter is no longer used in IxLoad 4.20 and subsequent releases.

NomDelay

This parameter is no longer used in IxLoad 4.20 and subsequent releases.

totalLimit

This parameter is no longer used in IxLoad 4.20 and subsequent releases.

frameLimit

This parameter is no longer used in IxLoad 4.20 and subsequent releases.

## EXAMPLE

```
$Activity_IPTV_VideoClient1 agent.pm.stats.config \
```

```
-MinDelay          5 \  
-PerStreamEntriesPerUser 4 \  
-MaxDelay          80 \  
-enableFrameStats  false \  
-NomDelay          20 \  
-qualityLimit      0 \  
-IgnoreLoss        false \  
-frameLimit        0 \
```

---

```
-JBEMode          0 \  
-enableVQmonStats      false \  
-vuserId          1 \  
-enableVuserMonitor   false \  
-totalLimit         0 \  
-updateInterval      2000 \  
-bufferSize         65535 \  
-bitrateLimit        0 \  
-nominalDelay        2
```

## Video Server Agent

Video Server Agent - create a video server

### SYNOPSIS

```
set Traffic2_Network2 [::IxLoad new ixNetTraffic]
set Activity_IPTV_VideoServer1 [$Traffic2_Network2 activityList.appendItem
options...]
$Activity_IPTV_VideoServer1 agent.config
```

### DESCRIPTION

A video server agent is added to the `activityList` object. The `activityList` object is added to the `ixNetTraffic` object using the `appendItem` subcommand from the `ixConfigSequenceContainer` command.

### SUBCOMMANDS

The options for this command are configured and read using the standard `config`, `cget`, and `getOptions` subcommands defined in the `ixConfig` command.

### OPTIONS

`enable`

Enables the use of this agent. (Default = true).

`name`

The name associated with this object, which must be set at object creation time.

### STATISTICS

### EXAMPLE

```
set Traffic2_Network2 [::IxLoad new
ixNetTraffic]##### Activity IPTV_
VideoServer1 of NetTraffic
Traffic2@Network2#####set Activity_IPTV_
VideoServer1 [$Traffic2_Network2 activityList.appendItem \-protocolAndType
"Video Server" ]set _Match_Longest_ [::IxLoad new ixMatchLongestTimeline]$Activity_
IPTV_VideoServer1 config \-enable true \-name
"IPTV_VideoServer1" \-timeline $_Match_Longest_$Activ-
ity_IPTV_VideoServer1 agent.config \-enable true \-
name "IPTV_VideoServer1"$Activity_IPTV_
VideoServer1 agent.pm.videoConfig.config \-serverMode
0$Activity_IPTV_VideoServer1 agent.pm.videoConfig.videoList.clear$Activity_IPTV_
VideoServer1 agent.pm.videoConfig.videoList.appendItem \-id
```

```

"Video" \-dest_port_incr                                0 \-addr_incr
"0.0.0.1" \-name                                        "Stream0" \-stream_count
10 \-          "" \-duration                            10 \-IP_type
"" \-type                                              "VoD" \-starting_dest_port
1234$Activity_IPTV_VideoServer1 agent.pm.advancedOptions.config \-enableEsm
false \-type_of_service_for_rtsp                      "Best Effort (0x0)" \-enableVlanPri-
ority_for_rtsp          true \-listen_port            554 \-
enableTosRTSP          false \-enableTosData
false \-link_speed          1000 \-type_of_service_for_data
"Best Effort (0x0)" \-esm          1460 \-vlan_priority_
rtsp          2$Activity_IPTV_VideoServer1 agent.p-
m.videoProp.stream.clear$Activity_IPTV_VideoServer1 agent.p-
m.videoProp.stream.appendItem \-id                    "Stream" \-
mpeg4_contains_hint_track          "" \-mpeg4_profile
"" \-num_frames          0 \-fileButton
false \-struct_c          "" \-mpeg4_trackID
0 \-ip_bit_rate          3.75 \-cbr
0 \-tsperudp          7 \-h264_contains_hint_track
"" \-duration          10 \-transport
1 \-dest_port_incr          0 \-addr_incr
"0.0.0.1" \-d_server_tos_or_dscp          "Best Effort (0x0)" \-h264_
trackID          0 \-tos_or_dscp          "Best
Effort (0x0)" \-hor_size          0 \-filename
"" \-content          "Synthetic Payload" \-same_source_ip
false \-hrd_buffer          0 \-h264_packetization_mode
1 \-hrd_rate          0 \-type
"VoD" \-enable_d_server_tos          false \-profile
0 \-starting_dest_port          1234 \-duration_in_packets
0 \-file_duration          0.0 \-min_frame_size
0 \-          "" \-frame_rate          0.0 \-max_ip_bit_rate
0.0 \-file_duration_in_rtp_clock          0.0 \-h264_ignore_hint_track
false \-h264_requires_fragmentation          "" \-mpeg4_level
"" \-enable_tos          false \-mpeg_type
"MPEG2 Transport Stream" \-name          "Stream0" \-vert_
size          0 \-level          0 \-
stream_count          10 \-max_packet_rate
0.0 \-max_frame_size          0 \-mpeg4_ignore_hint_track
false \-max_allowed_requests_d_server          1 \-h264_level
"" \-h264_profile          ""$Activity_IPTV_VideoServer1 agent.p-
m.predefined_tos_for_rtsp.clear$Activity_IPTV_VideoServer1 agent.pm.predefined_tos_
for_rtsp.appendItem \-id          "TypeOfServiceForRtsp"
\-tos_val_for_rtsp          "Best Effort (0x0)"$Activity_IPTV_
VideoServer1 agent.pm.predefined_tos_for_rtsp.appendItem \-id
"TypeOfServiceForRtsp" \-tos_val_for_rtsp          "Class 1
(0x20)"$Activity_IPTV_VideoServer1 agent.pm.predefined_tos_for_rtsp.appendItem \-id
"TypeOfServiceForRtsp" \-tos_val_for_rtsp          "Class 2
(0x40)"$Activity_IPTV_VideoServer1 agent.pm.predefined_tos_for_rtsp.appendItem \-id

```

```
"TypeOfServiceForRtsp" \-tos_val_for_rtsp                "Class 3"
(0x60)"$Activity_IPTV_VideoServer1 agent.pm.predefined_tos_for_rtsp.appendItem \-id
"TypeOfServiceForRtsp" \-tos_val_for_rtsp                "Class 4"
(0x80)"$Activity_IPTV_VideoServer1 agent.pm.predefined_tos_for_rtsp.appendItem \-id
"TypeOfServiceForRtsp" \-tos_val_for_rtsp                "Express Forwarding"
(0xA0)"$Activity_IPTV_VideoServer1 agent.pm.predefined_tos_for_rtsp.appendItem \-id
"TypeOfServiceForRtsp" \-tos_val_for_rtsp                "Control"
(0xC0)"$Activity_IPTV_VideoServer1 agent.pm.predefined_tos_for_data.clear$Activity_
IPTV_VideoServer1 agent.pm.predefined_tos_for_data.appendItem \-id
"TypeOfServiceForData" \-tos_val_for_data                "Best Effort"
(0x0)"$Activity_IPTV_VideoServer1 agent.pm.predefined_tos_for_data.appendItem \-id
"TypeOfServiceForData" \-tos_val_for_data                "Class 1"
(0x20)"$Activity_IPTV_VideoServer1 agent.pm.predefined_tos_for_data.appendItem \-id
"TypeOfServiceForData" \-tos_val_for_data                "Class 2"
(0x40)"$Activity_IPTV_VideoServer1 agent.pm.predefined_tos_for_data.appendItem \-id
"TypeOfServiceForData" \-tos_val_for_data                "Class 3"
(0x60)"$Activity_IPTV_VideoServer1 agent.pm.predefined_tos_for_data.appendItem \-id
"TypeOfServiceForData" \-tos_val_for_data                "Class 4"
(0x80)"$Activity_IPTV_VideoServer1 agent.pm.predefined_tos_for_data.appendItem \-id
"TypeOfServiceForData" \-tos_val_for_data                "Express Forwarding"
(0xA0)"$Activity_IPTV_VideoServer1 agent.pm.predefined_tos_for_data.appendItem \-id
"TypeOfServiceForData" \-tos_val_for_data                "Control (0xC0)"
```

## SEE ALSO

[ixNetTraffic](#)

## Video Properties

Video Properties—Adds a video stream.

### SYNOPSIS

```
set serverTraffic [::IxLoad new ixServerTraffic options]
$serverTraffic agentList.appendItem options...
$serverTraffic agentList(0).videoProp.appendItem options...
set Traffic2_Network2 [::IxLoad new ixNetTraffic]
set Activity_IPTV_VideoServer1 [$Traffic2_Network2 activityList.appendItem
options...]
```

### DESCRIPTION

A `videoProp` object is added to the `Video Client Agent` object using the `appendItem` subcommand from the `ixConfigSequenceContainer` command.

### SUBCOMMANDS

The options for this command are configured and read using the standard `config`, `cget`, and `getOption` subcommands defined in the `ixConfig` command.

### OPTIONS

`name`

Name of the video stream. (Default = "Stream0").

`type`

Type of the video stream. The choices for video mode are:

Value	Description
Multicast	Broadcast-type real-time video stream.
VoD	Video-on-Demand stream.



**Note:** If a stream uses a payload file containing MPEG-4 Part-2 video or H264 video, the `type` must be `VoD`; it cannot be `Multicast`.

The choices for IPTV mode are:

Value	Description
AD Server	<p>An <b>A</b> (Acquisition) server packages RTP streams into multicast UDP packets and streams them onto the distribution network.</p> <p>A <b>D</b> (Distribution) server caches a certain amount of the multicast video data being streamed over the network. When a user changes a channel, the D server sends a short unicast burst of the new channel's video traffic for the user to view while the system switches the user from the previous channel's multicast group to the new chan's group.</p>
V Server	A <b>V</b> server provides Video-on-Demand service to an IPTV client.

stream

This is a list of type `Stream`. The elements in this list comprise the list of streams available on the Video server. (Default = {}).

stream\_count

If the video or IPTV A Server `type` is Multicast, this parameter specifies the numof instances of this stream that will be streamed out. specifies the first Multicast Group Address.

If the video or D Server type is VoD, this parameter specifies how many instances of the stream that the server hosts.

Minimum = "1," Maximum = "1,000." (Default = "1").

set payloadfile

This option specifies the name of the video file that will be streamed by the IxLoad Video Server or IPTV Server. IxLoad Video Server can stream H264 and MPEG4 encoded video track, in a video file, provided the file is in MPEG-4 file format.

starting\_multicast\_group\_addr

For a Multicast channel, this field specifies the address of the first multicast group that the channel will be available on.

addr\_incr

If more than one instance of the Broadcast channel will be streamed out (`stream_count` is greater than 1), this parameter specifies the amount of increase in each multicast group address for the streams.

Minimum = "1," Maximum = "2,147,483,647." (Default = "1").

starting\_dest\_port

For a Multicast channel, this field specifies the first port number that the channel will be available on.

Minimum = "0," Maximum = "65,535." (Default = "0").

dest\_port\_incr



If more than one instance of the Multicast channel will be streamed out (`stream_count` is greater than 1), this parameter specifies the amount of increase in each port number for the streams. Minimum = "0," Maximum = "2,147,483,647." (Default = "0").

duration

If the stream type is VoD or D Server, this parameter specifies the duration of the video stream. Minimum = "0," Maximum = "2,147,483." (Default = "0").

### EXAMPLE

```
set payloadfile "D:/MPEG4/Cloud-vs11-withaudio(3.75Mbps).ts.MP4"puts
$payloadfileputs "Before adding Stream1."$svr_traffic agentList(0).p-
m.videoProp.stream.appendItem \      -name          "Stream1" \      -content
"Real Payload" \      -filename          $payloadfile \      -ip_bit_rate
"3.5000" \      -type          "VoD" \      -stream_count          "2" \      -
duration          "100"puts "After adding Stream1."#-----
-----#ipv6 example#-----
-----$svr_traffic agentList(0).pm.videoConfig.videoList(0).config \
-name          "Stream0" \      -type          "Multicast" \
- "FF04::13" \      -stream_count          1          \      -addr_incr
"0::1"
```

### SEE ALSO

[Video Server Agent](#)

## Advanced Options

Advanced Options—Sets the Video server agent’s global configuration options.

### SYNOPSIS

```
set Traffic2_Network2 [::IxLoad new ixNetTraffic]
set Activity_IPTV_VideoServer1 [$Traffic2_Network2 activityList.appendItem
options...]
$Activity_IPTV_VideoServer1 agent.pm.advancedOptions.config
```

### DESCRIPTION

A Video server’s advanced configuration options are set by modifying the options of the `pm.advancedOptions.config` option of the Video Server Agent object.

### SUBCOMMANDS

None.

### OPTIONS

`listen_port`

Port that RTSP server listens on for new connections. Minimum = "1," Maximum = "65,535." (Default = "554").

`enableEsm`

If true, the use of the ESM option is enabled. (Default = false).

`enableTosRTSP`

Enables the setting of the TOS (Type of Service) bits in the header of the RTSP control packets.

Value	Description
0	(default) TOS bits not enabled.
1	TOS bits enabled.

`enableTosData`

Enables the setting of the TOS (Type of Service) bits in the header of the RTSP data packets.

Value	Description
0	(default) TOS bits not enabled.
1	TOS bits enabled.

esm

If `enableEsm` is true, the ESM value to negotiate with. (Default = 1,460).

`type_of_service_for_rtsp`

If `enableTosRTSP` is true, this option specifies the IP Precedence / TOS (Type of Service) bit setting and Assured Forwarding classes. (Default = "Best Effort 0x0"). If you want to specify the standard choices that are in the GUI, you can use a string representation. To specify any of the other 255 TOS values, specify the decimal value. The default choices are:

Value	Description
"Best Effort (0x0)"	(Default) routine priority
"Class 1 (0x20)"	Priority service, Assured Forwarding class 1
"Class 2 (0x40)"	Immediate service, Assured Forwarding class 2
"Class 3 (0x60)"	Flash, Assured Forwarding class 3
"Class 4 (0x80)"	Flash-override, Assured Forwarding class 4
"Express Forwarding (0xA0)"	Critical-ecp
"Control (0xC0)"	Internet-control

`type_of_service_for_data`

If `enableTosData` is true, this option specifies the IP Precedence / TOS (Type of Service) bit setting and Assured Forwarding classes for RTSP data packets. See `type_of_service_for_rtsp` for the list of choices (Default = "Best Effort (0x0)").

`enableVlanPriority_for_rtsp`

VLAN Priority can be set on a per-activity basis or on a per-network (NetTraffic) basis. This parameter sets the VLAN priority for the activity. An activity's VLAN Priority bit setting takes precedence over a network's Priority bit setting. If true, IxLoad sets the VLAN Priority bit in traffic from this activity. Configure the VLAN priority value in `vlanPriority`. (Default = false).

`vlanPriority`

When `enableVlanPriority` is true, this option accepts the vlan priority value.

`enable_d_server_tos`

This enables (1) the Type of Service (ToS) bits. Default = 0.

`d_server_tos_or_dscp`

If `enable_d_server_tos` is set to 1, you can set the Type of Service (ToS) bits that will be set in this stream from the A server, D Server and V Server. The value set here can be over-riden by the value that is set for `d_server_tos_or_dscp` in `Stream` configuration. The available choices are:

Value	Description
Best Effort (0x0) (Default)	Routine service.
Class 1 (0x20)	Priority service, Assured Forwarding class 1
Class 2 (0x40)	Immediate service, Assured Forwarding class 2
Class 3 (0x60)	Flash, Assured Forwarding class 3
Class 4 (0x80)	Flash-override, Assured Forwarding class 4
Express Forwarding (0xA0)	Critical-ecp
Control (0xC0)	Internet-control



**Note:** This field only sets the ToS type for the multicast (data plane) traffic; the ToS type for IGMP packets (the control plane traffic) will remain set to 0xC0.

`enable_hwacc`

If `True`, hardware acceleration is used. Default = "false".

**EXAMPLE**

```
$Activity_IPTV_VideoServer1 agent.pm.advancedOptions.config \-enableEsm
false \-type_of_service_for_rtsp "Best Effort (0x0)" \-enableVlanPri-
ority_for_rtsp true \-listen_port 554 \-
enableTosRTSP false \-enableTosData
false \-link_speed 1000 \-type_of_service_for_data
"Best Effort (0x0)" \-esm 1460 \-vlan_priority_
rtsp 2
```

**SEE ALSO**

[Video Server Agent](#)

## Video Config

Video Config—Contains the list of video streams hosted by the IxLoad IPTV AD and V Servers.

### SYNOPSIS

```
set Traffic2_Network2 [::IxLoad new ixNetTraffic]
set Activity_IPTV_VideoServer1 [$Traffic2_Network2 activityList.appendItem
options...]
$Activity_IPTV_VideoServer1 agent.pm.videoConfig.config
```

### DESCRIPTION

A Video server's configuration options are set by modifying the options of the `pm.videoConfig.config` option of the Video Server Agent object.

### SUBCOMMANDS

None.

### OPTIONS

`a_port_ip`

IP address of the A server port. (Default = "")

`iptv_multiport_enable`

Indicates whether traffic from A and D server originates from the same ixia port or multiple ports. (Default = "0").

`serverMode`

Sets the server mode to Video or IPTV. (Default = "0").

### EXAMPLE

```
$Activity_IPTV_VideoServer1 agent.pm.videoConfig.config \-a_server_ip
"10.0.2.6" \-iptv_multiport_enable 1 \-serverMode
1
```

### SEE ALSO

[Advanced Options](#)

## IPTV / Video Statistics

The test results are available from the location defined on the User Directories window. See User Directories.

For the IPTV / Video client statistics, see [.IPTV / Video Client Statistics](#)

For the IPTV / Video server statistics, see [IPTV / Video Server Statistics](#)

For TCP statistics, see TCP, Run State, and Curve Segment Statistics.



**Note:** If the client is receiving a large number of streams (for example, about 820 1Mbps streams on an ALM1G client port), keep the page size (the number of rows) of the per-stream statistics view small. Having large page sizes (large numbers of rows per page) causes the statistics to not refresh correctly and causes paging (moving from one page to another) to take a long time.

## **IPTV / Video Client Statistics**

This section describes the statistics for IPTV and Video clients .

## Global Stream Statistics

The table below lists the IxLoad IPTV / Video client global stream statistics.

Statistic	Description
VoD Streams Playback Successful	Number of RTP streams played in which at least one packet was received.
VoD Streams With Errors	Number of RTP streams played in which one or more packets were lost.
Frame Stats Disabled	Deprecated
Quality Metrics Disabled	<p>Initially, this statistic displays no value.</p> <p>If the received data rate exceeds the cut-off threshold, IxLoad stops computing the Quality Metrics, and this statistic will display "YES".</p> <p>The value will remain YES until the end of the iteration. Once the Quality Metrics computation is disabled during a run, it remains disabled throughout the remainder of the run.</p> <p>Prior to starting the next run (or the next iteration of the same test), this statistic will be cleared and IxLoad will again begin computing the Quality Metrics. It will continue to compute the metrics as long as the bit rate remains below the cut-off threshold.</p> <p>Note for Tcl API users: For this statistic, use the Aggregation Type <i>kString</i>.</p>
Total Bytes Rcvd	Total number of bytes received by the client.
Total packets Rcvd	Total number of packets received by the client.
Total Loss	Total number MPEG2-TS packets lost.
Unexpected UDP Packets Received	Number of UDP packets received during a time when no channels are active.
Overload Packets Dropped	Number of RTP packets dropped because a port did not have enough computing power to process them.
Total RTP Packets Lost	Total number of RTP packets lost while using RTP over UDP transport.
Total Out Of Order RTP Packets Rcvd	Total number of RTP packets received in the wrong order while using RTP over UDP transport.



Total Duplicate RTP Packets	Total number of duplicate RTP packets received.
Global Jitter	Average variation in arrival times of packets on all streams. Note for Tcl API users: This is a weighted statistic. If you are using this statistic in a Tcl script, use the <i>kWeightedAverage</i> aggregation type.
RTCP Avg Packet Size	Average outbound RTCP packet size.
RTCP Avg Packet Transmission Time	Amount of time between the most recent two consecutive RTCP packets sent.
RTCP Packets Sent	Number of RTCP packets sent.
RTP Lost Sequence: One Packet	Number of instances in which 1 packet was lost.
RTP Lost Sequence: Two or Three Packets	Number of instances in which 2 or 3 consecutive packets were lost.
RTP Lost Sequence: Four or Five Packets	Number of instances in which 4 or 5 consecutive packets were lost.
RTP Lost Sequence: Six to Ten Packets	Number of instances in which 6-10 consecutive packets were lost.
RTP Lost Sequence: Eleven or More Packets	Number of instances in which 11 or more consecutive packets were lost.
RTP Maximum Lost Sequence	Maximum gap between the sequence numbers of RTP packets received on a stream. This statistic represents the maximum burst loss that has occurred in the network.
Jitter less than 50 us	Number of packets received with 0 to 50 microseconds of jitter.
Jitter between 50 - 100 us	Number of packets received with 50 to 100 microseconds of jitter.

Jitter between 100 - 500 us	Number of packets received with 100 -500 microseconds of jitter.
Jitter between 500 us - 2 ms	Number of packets received with 500 microseconds to 2 milliseconds of jitter.
Jitter between 2 - 5 ms	Number of packets received with 2 to 5 milliseconds of jitter.
Jitter between 5 - 10 ms	Number of packets received with 5 to 10 milliseconds of jitter.
Jitter greater than 10 ms	Number of packets received with more than 10 milliseconds of jitter.
Packet Size between 0 - 100 bytes	Number of packets received that were between 100 and 200 bytes in size.
Packet Size between 100 - 200 bytes	Number of packets received that were between 100 and 200 bytes in size.
Packet Size between 200 - 400 bytes	Number of packets received that were between 200 and 400 bytes in size.
Packet Size between 400 - 600 bytes	Number of packets received that were between 400 and 600 bytes in size.
Packet Size between 600 - 1000 bytes	Number of packets received that were between 600 and 1000 bytes in size.
Packet Size greater than 1000 bytes	Number of packets received that were larger than 1000 bytes.
Inter Packet Arrival Time between 0 - 2 ms	Number of packets that arrived less than 2 milliseconds after the preceding packet was received.
Inter Packet Arrival Time between 2 - 5 ms	Number of packets that arrived between 2 and 5 milliseconds after the preceding packet was received.

Inter Packet Arrival Time between 5 - 10 ms	Number of packets that arrived between 5 and 10 milliseconds after the preceding packet was received.
Inter Packet Arrival Time between 10 - 25 ms	Number of packets that arrived between 10 and 25 milliseconds after the preceding packet was received.
Inter Packet Arrival Time between 25 - 50 ms	Number of packets that arrived between 25 and 50 milliseconds after the preceding packet was received.
Inter Packet Arrival Time between 50 - 100 ms	Number of packets that arrived between 50 and 100 milliseconds after the preceding packet was received.
Inter Packet Arrival Time between 100 - 200 ms	Number of packets that arrived between 100 and 200 milliseconds after the preceding packet was received.
Inter Packet Arrival Time between 200 - 500 ms	Number of packets that arrived between 200 and 500 milliseconds after the preceding packet was received.
Inter Packet Arrival Time greater than 500 ms	Number of packets that arrived more than 500 milliseconds after the preceding packet was received.
<b>Note:</b> The following packet latency statistics are only available for streams from an IxLoad Video server with synthetic payloads.	
Packet Latency between 0 - 2 ms	Number of UDP packets that required between 0 and 2 milliseconds to travel from the server to the client.
Packet Latency between 2 - 5 ms	Number of UDP packets that required between 2 and 5 milliseconds to travel from the server to the client.
Packet Latency between 5 - 10 ms	Number of UDP packets that required between 5 and 10 milliseconds to travel from the server to the client.

Packet Latency between 10 - 25 ms	Number of UDP packets that required between 10 and 25 milliseconds to travel from the server to the client.
Packet Latency between 25 - 50 ms	Number of UDP packets that required between 25 and 50 milliseconds to travel from the server to the client.
Packet Latency between 50 - 100 ms	Number of UDP packets that required between 50 and 100 milliseconds to travel from the server to the client.
Packet Latency between 100 - 200 ms	Number of UDP packets that required between 100 and 200 milliseconds to travel from the server to the client.
Packet Latency between 200 - 500 ms	Number of UDP packets that required between 200 and 500 milliseconds to travel from the server to the client.
Packet Latency greater than 500 ms	Number of UDP packets that more than 500 milliseconds to travel from the server to the client.
Avg Packet Latency	<p>Average amount of time required for a packet to travel from the server to the client.</p> <p>Note for Tcl API users: This is a weighted statistic. If you are using this statistic in a Tcl script, use the <i>kWeightedAverage</i> aggregation type.</p>
Max Packet Latency	<p>Maximum amount of time required for a packet to travel from the server to the client.</p> <p>For Dummy payloads, this statistic is updated only if the packets are sent over RTP transport.</p> <p>For Synthetic payloads, this statistic is updated for packets sent over UDP or RTP transport, but only if Hardware Acceleration is disabled.</p>

## Per-Stream Statistics

The table below lists the IxLoad IPTV / Video client statistics that are available on a per-stream basis.

The per-stream view displays statistics on the active stream for each user. To display meaningful values for the Leave Latency, Channel Overlap Duration, and Channel Gap Duration statistics, you should set the Entries per User in Per Stream Stats (on the Statistics Options tab) as follows:

- If Concurrent Channel View Sequence is set to 1, set Entries per User in Per Stream Stats to 2.
- If Concurrent Channel View Sequence is set to 2, set Entries per User in Per Stream Stats to 4 (the maximum value).

These values will ensure that the statistics values for a previous stream are retained, and that values for the Leave Latency, Channel Overlap Duration, and Channel Gap Duration statistics will be displayed. Otherwise, these statistics may display as 0.

	<p><b>Note:</b> In Video mode, the per-stream statistics view displays as: <i>Video Client Per Stream.</i></p> <p>In IPTV mode, the per-stream statistics view displays as : <i>Video Client IPTV Per Stream.</i></p>	
Statistic	Description	
Active	<p>Indicates whether the stream is active or not: 0 = inactive 1 = active Note for Tcl API users: For this statistic, use the Aggregation Type <i>kString</i>.</p>	
Stream Name	<p>Name of stream. Note for Tcl API users: For this statistic, use the Aggregation Type <i>kString</i>.</p>	
Flow ID	<p>Number identifying the flow used by the stream. A flow consists of the packets flowing between a source IP:port and a destination IP:port. Note for Tcl API users: For this statistic, use the Aggregation Type <i>kString</i>.</p>	
Transport	<p>Type of transport used on the stream. Note for Tcl API users: 0 = UDP 1 = RTP/UDP For this statistic, use the Aggregation Type <i>kString</i>.</p>	

Video Codec	Video codec used on the stream. Note for Tcl API users: For this statistic, use the Aggregation Type <i>kString</i> .
Stream Bit Rate	Bit rate used on stream.
Bytes	Number of bytes received on the stream.
Packets	Number of packets received on the stream.
Loss	Number of packets lost on the stream.
Maximum Lost Sequence	Maximum gap between the sequence numbers of RTP packets received on the stream. This statistic represents the maximum burst loss that has occurred on the stream.
MDI-DF	Media Delivery Index - Delay Factor (MDI-DF) experienced on stream.
MIN MDI-DF	Smallest MDI Delay Factor experienced on stream. <b>Note:</b> When retrieved from the Tcl API, this statistic is returned in units of nano-seconds (ns).
MAX MDI-DF	Largest MDI Delay Factor experienced on stream. <b>Note:</b> When retrieved from the Tcl API, this statistic is returned in units of nano-seconds (ns).
AVG-MDI-DF	Average MDI Delay Factor experienced on stream. <b>Note:</b> When retrieved from the Tcl API, this statistic is returned in units of nano-seconds (ns).
MDI-MLR	Media Delivery Index - Media Loss Rate experienced on stream.
Jitter	Current instantaneous jitter.
Inter Pkt Arrival Time	Amount of time between received packets.
Min Inter Pkt Arrival Time	Smallest amount of time between received packets, in milliseconds.
Max Inter Pkt Arrival Time	Largest amount of time between received packets, in milliseconds.
Packet Latency (ns)	Average packet latency on the stream.
Min Packet Latency (ns)	Smallest packet latency on the stream.

Max Packet Latency (ns)	Longest packet latency on the stream.
Play Latency (ms)	Amount of time, in milliseconds, elapsed between the time the IPTV client sent an IGMP JOIN (to play a multicast channel on an AD server) or RTSP PLAY (to play a VoD channel on a V server) and the time it received the first byte of data.
Join Latency (ms)	Amount of time, in milliseconds, elapsed between the time the client sent an IGMP JOIN (broadcast channel) or RTSP PLAY (VoD channel) and the time it received the first byte of data. Note for Tcl API users: This is a weighted statistic. If you are using this statistic in a Tcl API script, use the <code>kWeightedAverage</code> aggregation type.
Leave Latency (ms)	Amount of time, in milliseconds, elapsed between the time the client sent an IGMP LEAVE (broadcast channel) or RTSP PAUSE (VoD channel) and the time it received the last byte of data. Leave latency has a maximum timeout of 10 seconds; if the client continues to receive data 10 seconds after it has sent the Leave command, the latency is measured as 10 seconds. This statistic is valid only for IGMPv2. For IGMPv3, Leaves for multicast groups are sent by sending an IGMP report with the modified group list. Note for Tcl API users: This is a weighted statistic. If you are using this statistic in a Tcl API script, use the <code>kWeightedAverage</code> aggregation type.
Channel Switch Latency	Amount of time elapsed between the time the client sent an IGMP LEAVE to change to a new channel, and the time it received the first byte of the new stream. Note for Tcl API users: This is a weighted statistic. If you are using this statistic in a Tcl script, use the <code>kWeightedAverage</code> aggregation type.
Channel Gap Duration	When changing channels, this statistic measures the amount of time elapsed between the time the client received the last byte of the old stream and the time it received the first byte of the new stream.
Channel Overlap Duration	When changing channels, this statistic measures the amount of time that the client was simultaneously receiving both the old and new streams.
Control Sent	Indicates the type of control command that has most recently been sent: 0 = LEAVE or PAUSE/TEARDOWN sent 1 = JOIN or PLAY sent
Data Rcvd	Indicates whether or not data is being received: 0 = no data received 1 = data received

RTP Packets Lost	Number of RTP packets lost.
RTP Packets Out of Order	Number of RTP packets received out of order.
RTP Packets Duplicated	Number of duplicate RTP packets received.
ICC Unicast Bytes (IPTV mode only)	Number of unicast bytes received by the client.
ICC Unicast Packets (IPTV mode only)	Number of unicast packets received by the client.
ICC Multicast Bytes (IPTV mode only)	Number of multicast bytes received by the client.
ICC Multicast Packets (IPTV mode only)	Number of multicast packets received by the client.
ICC Packets Lost or Dup Due To Switch (IPTV mode only)	<p>Number of packets lost or duplicated due to switching from a unicast (D server) stream to a multicast (A server) stream.</p> <p>If packets were lost, this statistic is displayed with a minus-sign (-). For example, -100 indicates that 100 packets were lost.</p> <p>If packets were duplicated, this statistic is displayed with a plus-sign (+). For example, +100 indicates that 100 packets were duplicated.</p>
Unicast-Multicast Switch Latency (ms)	<p>Time elapsed switching from a VOD (unicast) stream to a broadcast (multicast) stream.</p> <p>This statistic is only returned for the ICC command for MSIPTV emulation.</p>
RTCP Packets Sent	<p>Number of RTCP packets sent.</p> <p>Note for Tcl API users: This is a weighted statistic. If you are using this statistic in a Tcl script, use the <i>kWeightedAverage</i> aggregation type.</p>



## Video Client Data Conditional Statistics

The table below lists the IxLoad IPTV / Video client data QoE Detective statistics.

The QoE Detective column indicates the views in which a statistic is available:

**IP:** per-IP view

**User:** per-User view

**VLAN:** per-VLAN view

**All:** all views

Statistic	QoE Detective	Description
UDP Bytes Received	All	Number of UDP bytes received.
UDP Packets Received	All	Number of UDP packets received.
MPEG2 TS Loss	All	Number of MPEG-2 Transport Stream packets lost. This statistic differs from the <i>Total TS Loss</i> statistic in that Total TS Loss measures the total MPEG2 TS packet lost, while this statistic measures only the loss on for the IP address, VLAN, or user.
MDI-DF (ms)	User	Media Delivery Index - Delay Factor (MDI-DF) experienced on stream.
MDI-MLR	User	Media Delivery Index - Media Loss Rate experienced on stream.
Avg MDI-DF (ms)	All	Average MDI Delay Factor experienced on stream. <b>Note:</b> When retrieved from the Tcl API, this statistic is returned in units of nanoseconds (ns).
Min MDI-DF (ms)	All	Smallest MDI Delay Factor experienced on stream. <b>Note:</b> When retrieved from the Tcl API, this statistic is returned in units of nanoseconds (ns).
Max MDI-DF (ms)	All	Largest MDI Delay Factor experienced on stream. <b>Note:</b> When retrieved from the Tcl API, this statistic is returned in units of nanoseconds (ns).
Stream Bit Rate (Kbps)	User	Bit rate used on stream.

Avg Stream Bit Rate (Kbps)	All	Average bit rate calculated for the stream.
Received Bit Rate (Kbps)	All	Actual bit rate of received stream.
RTP Clock Rate	User	Clock rate used for RTP connection.
RTP SSRC	User	Value of the SSRC field in RTP packets in the stream.
Video PID	User	Package Identifier used on video stream
Audio PID	User	Package Identifier used on audio stream.
RTP Packets Lost	All	Total number of RTP packets lost while using RTP over UDP transport.
RTP Packets Out of Order	All	Total number of RTP packets received in the wrong order while using RTP over UDP transport.
RTP Packets Duplicate	All	Number of duplicate RTP packets received.
Join Latency (ms)	User	Amount of time, in milliseconds, elapsed between the time the client sent an IGMP JOIN (broadcast channel) or RTSP PLAY (VoD channel) and the time it received the first byte of data. Note for Tcl API users: This is a weighted statistic. If you are using this statistic in a Tcl API script, use the <code>kWeightedAverage</code> aggregation type.
Leave Latency (ms)	User	Amount of time, in milliseconds, elapsed between the time the client sent an IGMP LEAVE (broadcast channel) or RTSP PAUSE (VoD channel) and the time it received the last byte of data. Leave latency has a maximum timeout of 10 seconds; if the client continues to receive data 10 seconds after it has sent the Leave command, the latency is measured as 10 seconds. This statistic is valid only for IGMPv2. For IGMPv3, Leaves for multicast groups are sent by sending an IGMP report with the modified group list. Note for Tcl API users: This is a weighted statistic. If you are using this statistic in a Tcl API script, use the <code>kWeightedAverage</code> aggregation type.

Channel Switch Latency (ms)	User	Average time elapsed between the time the client changed to a new channel and the time it received the first byte of the new stream.
Channel Overlap Duration (ms)	User	When changing channels, this statistic measures the amount of time that the client was simultaneously receiving both the old and new streams.
Channel Gap Duration (ms)	User	When changing channels, this statistic measures the amount of time elapsed between the time the client received the last byte of the old stream and the time it received the first byte of the new stream.
Avg Inter Pkt Arrival Time (us)	All	Amount of time between received packets. This statistic differs from the <i>Inter-Packet Arrival Time</i> statistic in that this statistic is an average, while <i>Inter-Packet Arrival Time</i> is an instantaneous measure.
Min Inter Pkt Arrival Time (us)	All	Smallest amount of time between received packets, in milliseconds.
Max Inter Pkt Arrival Time (us)	All	Largest amount of time between received packets, in milliseconds.
Avg One Way Delay (us)	All	Average latency on the stream measured in one direction.
Min One Way Delay (us)	All	Shortest latency on the stream measured in one direction.
Max One Way Delay (us)	All	Longest latency on the stream measured in one direction.
Avg Packet Latency (us)	All	Average packet latency on the stream.
Avg Jitter (us)	All	Current instantaneous jitter.

Min Jitter (us)	All	Smallest jitter encountered on the stream.
Max Jitter (us)	All	Largest jitter encountered on the stream.
Transport	User	Type of transport used on the stream. Note for Tcl API users: 0 = UDP 1 = RTP/UDP For this statistic, use the Aggregation Type <i>kString</i> .

## Multicast and VoD Global Statistics

The table below lists the global IxLoad IPTV / Video client multicast and VoD statistics.

Statistic	Description
Active Multicast Channels	Number of multicast channels joined across all users.
Multicast Channels Requested	Number of multicast channels that the client requested.
Multicast Requests Successful	Number of multicast requests for which the client received a successful response.
Multicast Requests Failed	Number of multicast requests for which the client received a failure response.
VoD Streams Played	Total number of VoD streams played by the client.
VoD Streams Playback Successful	Number of VoD streams played to completion by the client.
VoD Streams Played Failed	Number of VoD streams that could not be played.

## Multicast and VoD QoE Detective Statistics

The table below lists the IxLoad IPTV / Video client multicast and VoD statistics that are available in QoE Detective.

The QoE Detective column indicates the views in which a statistic is available:

**IP:** per-IP view

**User:** per-User view

**VLAN:** per-VLAN view

**All:** all views

Statistic	QoE Detective	Description
Active Multicast Channels	All	Number of multicast channels joined across all users.

Multicast Channels Requested	All	Number of multicast channels that the client requested.
Multicast Requests Successful	All	Number of multicast requests for which the client received a successful response.
Multicast Requests Failed	All	Number of multicast requests for which the client received a failure response.
VoD Streams Played	All	Total number of VoD streams played by the client.
VoD Streams Playback Successful	All	Number of VoD streams played to completion by the client.
VoD Streams Played Failed	All	Number of VoD streams that could not be played.

## IGMP and MLD QoE Detective Statistics

The table below lists the IxLoad IPTV / Video client IGMP and MLD that are available in QoE Detective view.

The QoE Detective column indicates the views in which a statistic is available:

**IP:** per-IP view

**User:** per-User view

**VLAN:** per-VLAN view

**All:** all views

Statistic	QoE Detective	Description
<b>IGMP Statistics</b>		
IGMPv1 Reports Sent	All	Number of IGMP version 1 Report messages sent.
IGMPv2 Reports Sent	All	Number of IGMP version 2 Report messages sent.
IGMPv2 Leaves Sent	All	Number of IGMP version 2 Leave messages sent.
IGMPv3 Reports Sent	All	Number of IGMP version 3 Report messages sent.
IGMP General Query Received	All	Number of IGMP General Query messages received.
IGMP Group Query Received	All	Number of IGMP Group Query messages received.
IGMPv3 Group Source Query Received	All	Number of IGMP version 3 Group Source Query messages received.
IGMPv1 Reports Received	All	Number of IGMP version 1 Report messages received.
IGMPv2 Reports Received	All	Number of IGMP version 2 Report messages received.
IGMPv3 Reports Received	All	Number of IGMP version 3 Report messages received.
<b>MLD Statistics</b>		
MLDv1 General Query Received	All	Number of MLD version 1 General Query messages received.
MLDv2 General Query Received	All	Number of MLD version 2 General Query messages received.
MLDv1 Group Query Received	All	Number of MLD version 1 Group Query messages received.

MLDv2 Group Query Received	All	Number of MLD version 2 Group Query messages received.
MLDv2 Group Source Query Received	All	Number of MLD version 2 Group Source Query messages received.
MLDv1 Reports Sent	All	Number of MLD version 1 Report messages received.
MLDv2 Reports Sent	All	Number of MLD version 2 Report messages sent.
MLDv1 Leave Sent	All	Number of MLD version 1 Leave messages sent.
MLDv1 Reports Received	All	Number of MLD version 1 Report messages received.
MLDv2 Reports Received	All	Number of MLD version 2 Report messages received.



## IPTV Global Statistics

The table below lists the IxLoad IPTV / Video client statistics for IPTV clients.

	<b>Note:</b> IGMP and MLD are not applicable to VoD, so in a VoD test, no IGMP or MLD statistics are displayed.	
Statistic	Description	
Active D Server Channels	Number of streams currently playing on the D server.	
Active V Server Channels	Number of streams currently playing on the V server.	
D Server Channels Requested	Number of streams requested from the D server.	
D Server Requests Successful	Number of requests to the D server that were successful.	
D Server Requests Failed	Combined total of control and data requests to the D server that failed.	
D Server Requests Failed (Control)	Number of control plane requests to the D server that failed.	
D Server Requests Failed (Data)	Number of data plane requests to the D server that failed.	
V Server Channels Requested	Number of streams requested from the V server.	
V Server Requests Successful	Number of requests to the V server that were successful.	
V Server Requests Failed	Combined total of control and data requests to the V server that failed.	
V Server Requests Failed (Control)	Number of control plane requests to the V server that failed.	
V Server Requests Failed (Data)	Number of data plane requests to the V server that failed.	
IGMP Queries Rcvd	Number of IGMP Query messages received by the client.	

IGMP Reports Sent	Number of IGMP Report messages sent by the client for all users.
IGMP Leaves Sent	Number of IGMP Leave messages sent by the client.
MLD Queries Rcvd	Number of MLD Report messages received.
MLD Reports Sent	Number of MLD Report messages sent.
MLD Leaves Sent	Number of MLD Leave messages sent.
Join Latency	<p>Amount of time, in milliseconds, elapsed between the time the client sent an IGMP JOIN (broadcast channel) or RTSP PLAY (VoD channel) and the time it received the first byte of data.</p> <p>Note for Tcl API users: This is a weighted statistic. If you are using this statistic in a Tcl API script, use the <code>kWeightedAverage</code> aggregation type.</p>
Leave Latency	<p>Amount of time, in milliseconds, elapsed between the time the client sent an IGMP LEAVE (broadcast channel) or RTSP PAUSE (VoD channel) and the time it received the last byte of data.</p> <p>Leave latency has a maximum timeout of 10 seconds; if the client continues to receive data 10 seconds after it has sent the Leave command, the latency is measured as 10 seconds.</p> <p>This statistic is valid only for IGMPv2. For IGMPv3, Leaves for multicast groups are sent by sending an IGMP report with the modified group list.</p> <p>Note for Tcl API users: This is a weighted statistic. If you are using this statistic in a Tcl API script, use the <code>kWeightedAverage</code> aggregation type.</p>
Channel Switch Latency	<p>Amount of time elapsed between the time the client sent an IGMP LEAVE to change to a new channel, and the time it received the first byte of the new stream.</p> <p>Note for Tcl API users: This is a weighted statistic. If you are using this statistic in a Tcl script, use the <code>kWeightedAverage</code> aggregation type.</p>
RTSP Bytes Sent	Number of bytes sent by the RTSP client, including the payload and all headers.
RTSP Bytes Received	Number of bytes received in RTSP messages.
RTSP Packets Sent	Number of RTSP packets sent by the client.
RTSP Packets Received	Number of RTSP packets received by the client.
RTSP Concurrent Sessions	Number of concurrent RTSP sessions maintained.

RTSP Connection Rate	Rate at which the client established RTSP connections.
RTSP Transactions	Number of RTSP transactions completed.
RTSP Transaction Rate	Rate at which the client completed RTSP transactions.
RTSP Connections	Number of RTSP connections established by the client.
RTSP Setup Latency (ms)	Amount of time elapsed, in milliseconds, between a client sending a request to establish an RTSP connection and receiving the first byte of the response. Note for Tcl API users: This is a weighted statistic. If you are using this statistic in a Tcl script, use the kWeightedAverage aggregation type.
RTSP Teardown Latency (ms)	Amount of time elapsed, in milliseconds, between a client sending a request to end an RTSP connection and receiving the first byte of the response. Note for Tcl API users: This is a weighted statistic. If you are using this statistic in a Tcl script, use the kWeightedAverage aggregation type.
RTSP Play Latency (0 ms - 10 ms)	Number of instances in which 0 to 10 milliseconds elapsed between the time a client sent a PLAY command and the time it received the first byte of the media stream.
RTSP Play Latency (10 ms - 50 ms)	Number of instances in which 10 to 50 milliseconds elapsed between the time a client sent a PLAY command and the time it received the first byte of the media stream.
RTSP Play Latency (50 ms - 100 ms)	Number of instances in which 50 to 100 milliseconds elapsed between the time a client sent a PLAY command and the time it received the first byte of the media stream.
RTSP Play Latency (100 ms - 300 ms)	Number of instances in which 100 to 300 milliseconds elapsed between the time a client sent a PLAY command and the time it received the first byte of the media stream.
RTSP Play Latency (300 ms - 1 s)	Number of instances in which 300 to 1000 milliseconds elapsed between the time a client sent a PLAY command and the time it received the first byte of the media stream.
RTSP Play Latency (Greater Than 1s)	Number of instances in which more than one second elapsed between the time a client sent a PLAY command and the time it received the first byte of the media stream.
RTSP Presentations Active	Number of RTSP presentations available.

RTSP Presentations Playing	Number of RTSP presentations playing.
RTSP Presentations Paused	Number of RTSP presentations paused.
RTSP Presentations Requested	Number of RTSP presentations requested by the client.
RTSP Presentation Requests Successful	Number of presentation requests sent by the client for which it received a successful response.
RTSP Presentation Requests Failed	Number of presentation requests sent by the client that failed.
RTSP SET PARAMETER Sent	Number of RTSP SET PARAMETER messages sent.
RTSP GET PARAMETER Sent	Number of RTSP GET PARAMETER messages sent.
RTSP DESCRIBE Sent	Number of RTSP DESCRIBE messages sent.
RTSP SETUP Sent	Number of RTSP SETUP messages sent.
RTSP PLAY Sent	Number of RTSP PAUSE commands sent.
RTSP PAUSE Sent	Number of RTSP PAUSE commands sent.
RTSP TEARDOWN Sent	Number of RTSP TEARDOWN commands sent.
RTSP DESCRIBE Successful	Number of RTSP DESCRIBE commands for which a successful response was received.
RTSP SETUP Successful	Number of RTSP SETUP commands for which a successful response was received.
RTSP SET PARAMETER Successful	Number of RTSP SET PARAMETER commands for which a successful response was received.
RTSP GET PARAMETER Successful	Number of RTSP GET PARAMETER commands for which a successful response was received.
RTSP PLAY Successful	Number of RTSP PLAY commands for which a successful response was received.

RTSP PAUSE Successful	Number of RTSP PAUSE commands for which a successful response was received.
RTSP TEARDOWN Successful	Number of RTSP TEARDOWN commands for which a successful response was received.
RTSP DESCRIBE Failed	Number of RTSP DESCRIBE commands that failed.
RTSP SETUP Failed	Number of RTSP SETUP commands that failed.
RTSP SET PARAMETER Failed	Number of SET_PARAMETER replies received with a code other than OK (200).
RTSP GET PARAMETER Failed	Number of RTSP GET PARAMETER commands that failed.
RTSP PLAY Failed	Number of RTSP PLAY commands that failed.
RTSP PAUSE Failed	Number of RTSP PAUSE commands that failed.
RTSP TEARDOWN Failed	Number of RTSP TEARDOWN commands that failed.
Average Play latency	Average amount of time elapsed between the time the client sent a Play command and the time it received the first byte of the video stream. Note for Tcl API users: This is a weighted statistic. If you are using this statistic in a Tcl script, use the <i>kWeightedAverage</i> aggregation type.
Average Pause latency	Average amount of time elapsed between the time the client sent a Pause command and the time it stopped receiving data from the video stream. Note for Tcl API users: This is a weighted statistic. If you are using this statistic in a Tcl script, use the <i>kWeightedAverage</i> aggregation type.
Video Simulated Users	Number of users simulated by the client.

## IPTV QoE Detective Statistics

The table below lists the IxLoad IPTV / Video client statistics for IPTV clients in QoE Detective.

	<b>Note:</b> IGMP and MLD are not applicable to VoD, so in a VoD test, no IGMP or MLD statistics are displayed.
---	---

The QoE Detective column indicates the views in which a statistic is available:

**IP:** per-IP view

**User:** per-User view

**VLAN:** per-VLAN view

**All:** all views

Statistic	QoE Detective	Description
Active D Server Channels	All	Number of streams currently playing on the D server.
Active V Server Channels	All	Number of streams currently playing on the V server.
D Server Channels Requested	All	Number of streams requested from the D server.
D Server Requests Successful	All	Number of requests to the D server that were successful.
D Server Requests Failed	All	Combined total of control and data requests to the D server that failed.
D Server Requests Failed (Control)	All	Number of control plane requests to the D server that failed.
D Server Requests Failed (Data)	All	Number of data plane requests to the D server that failed.
V Server Channels Requested	All	Number of streams requested from the V server.
V Server Requests Successful	All	Number of requests to the V server that were successful.
V Server Requests Failed	All	Combined total of control and data requests to the V server that failed.
V Server Requests Failed (Control)	All	Number of control plane requests to the V server that failed.
V Server Requests Failed (Data)	All	Number of data plane requests to the V server that failed.

## RTSP QoE Detective Statistics

The table below lists QoE Detective the IxLoad IPTV / Video client statistics for IPTV clients.



**Note:** IGMP and MLD are not applicable to VoD, so in a VoD test, no IGMP or MLD statistics are displayed.

The QoE Detective column indicates the views in which a statistic is available:

**IP:** per-IP view

**User:** per-User view

**VLAN:** per-VLAN view

**All:** all views

Statistic	QoE Detective	Description
RTSP Bytes Sent	All	Number of bytes sent by the RTSP client, including the payload and all headers.
RTSP Bytes Received	All	Number of bytes received in RTSP messages.
RTSP Packets Sent	All	Number of RTSP packets sent by the client.
RTSP Packets Received	All	Number of RTSP packets received by the client.
RTSP Concurrent Sessions	All	Number of concurrent RTSP sessions maintained.
RTSP Connection Rate	All	Rate at which the client established RTSP connections.
RTSP Transactions	All	Number of RTSP transactions completed.
RTSP Transaction Rate	All	Rate at which the client completed RTSP transactions.
RTSP Connections	All	Number of RTSP connections established by the client.
RTSP Setup Latency (ms)	All	Amount of time elapsed, in milliseconds, between a client sending a request to establish an RTSP connection and receiving the first byte of the response.

RTSP Teardown Latency (ms)	All	Amount of time elapsed, in milliseconds, between a client sending a request to end an RTSP connection and receiving the first byte of the response. Note for Tcl API users: This is a weighted statistic. If you are using this statistic in a Tcl script, use the kWeightedAverage aggregation type.
RTSP Presentations Active	All	Number of RTSP presentations available.
RTSP Presentations Playing	All	Number of RTSP presentations playing.
RTSP Presentations Paused	All	Number of RTSP presentations paused.
RTSP Presentations Requested	All	Number of RTSP presentations requested by the client.
RTSP Presentation Requests Successful	All	Number of presentation requests sent by the client for which it received a successful response.
RTSP Presentation Requests Failed	All	Number of presentation requests sent by the client that failed.
RTSP DESCRIBE Sent	All	Number of RTSP DESCRIBE messages sent.
RTSP SETUP Sent	All	Number of RTSP SETUP messages sent.
RTSP SET PARAMETER Sent	All	Number of RTSP SET PARAMETER messages sent.
RTSP GET PARAMETER Sent	All	Number of RTSP GET PARAMETER messages sent.
RTSP OPTIONS Sent	All	Number of RTSP OPTIONS messages sent.
RTSP PLAY Sent	All	Number of RTSP PLAY messages sent.
RTSP PAUSE Sent	All	Number of RTSP PAUSE commands sent.
RTSP TEARDOWN Sent	All	Number of RTSP TEARDOWN commands sent.



RTSP DESCRIBE Successful	All	Number of RTSP DESCRIBE commands for which a successful response was received.
RTSP SETUP Successful	All	Number of RTSP SETUP commands for which a successful response was received.
RTSP SET PARAMETER Successful	All	Number of RTSP SET PARAMETER commands for which a successful response was received.
RTSP GET PARAMETER Successful	All	Number of RTSP GET PARAMETER commands for which a successful response was received.
RTSP OPTIONS Successful	All	Number of RTSP OPTIONS commands for which a successful response was received.
RTSP PLAY Successful	All	Number of RTSP PLAY commands for which a successful response was received.
RTSP PAUSE Successful	All	Number of RTSP PAUSE commands for which a successful response was received.
RTSP TEARDOWN Successful	All	Number of RTSP TEARDOWN commands for which a successful response was received.
RTSP DESCRIBE Failed	All	Number of RTSP DESCRIBE commands that failed.
RTSP SETUP Failed	All	Number of RTSP SETUP commands that failed.
RTSP SET PARAMETER Failed	All	Number of SET_PARAMETER replies received with a code other than OK (200).
RTSP GET PARAMETER Failed	All	Number of RTSP GET PARAMETER commands that failed.
RTSP OPTIONS Failed	All	Number of RTSP OPTIONS commands that failed.
RTSP PLAY Failed	All	Number of RTSP PLAY commands that failed.
RTSP PAUSE Failed	All	Number of RTSP PAUSE commands that failed.

RTSP TEARDOWN Failed	All	Number of RTSP TEARDOWN commands that failed.
Average Play latency (ms)	All	Average amount of time elapsed between the time the client sent a Play command and them time it received the first byte of the video stream.
Average Pause latency (ms)	All	Average amount of time elapsed between the time the client sent a Pause command and the time it stopped receiving data from the video stream.

## Video Quality Statistics

This section describes the video quality (TVQM VQmon/HD) statistics.

### Global Video Quality Statistics

The table below lists the IxLoad IPTV / Video global video quality statistics.

These statistics measure the overall video and audio quality of all the currently active streams.

	<b>Note:</b> Relative and Absolute MOS scores are described in Mean Opinion Score (MOS).	
Statistic	Description	
I Frames Rcvd	The number of video I-frames received.	
P Frames Rcvd	The number of video P-frames received.	
B Frames Rcvd	The number of video B-frames received.	
I Frames Impaired	Number of I-frames impaired due to packet loss or discards.	
P Frames Impaired	Number of P-frames impaired due to packet loss and/or discards. This does not include frames impaired due to error propagation through temporal reference.	
B Frames Impaired	Number of B-frames impaired due to packet loss and/or discards. This does not include frames impaired due to error propagation through temporal reference.	
Avg Curr Abs MOS V	Absolute MOS for all the currently active video streams, averaged from stream start to the current time.	
Avg Curr Rel MOS V	Relative MOS for all the currently active video streams, averaged from stream start to the current time.	
Avg Curr MOS AV	Audio/video (multimedia) MOS for all the currently active streams, averaged from stream start to the current time.	
Avg Curr MOS A	Absolute audio MOS, averaged from stream start to the current time.	
Avg Comp Abs MOS V	Absolute MOS for all completed video streams, averaged across all streams.	
Avg Comp Rel MOS V	Relative MOS for all completed video streams, averaged across all streams.	

Avg Comp MOS AV	Audio/video (multimedia) MOS for all completed streams, averaged across all streams.
Avg Comp MOS A	Audio MOS for all completed streams, averaged across all streams.
Avg Interval Abs MOS V	Absolute MOS, averaged over the most recent statistics Update Interval (you can configure the Update Interval is on the video client Statistics Options tab).
Avg Interval Rel MOS V	Relative MOS averaged over the most recent statistics Update Interval (you can configure the Update Interval on the video client Statistics Options tab).
Avg Video Bw	The average video bandwidth, in bits/second, excluding transport packet header overhead and error correction/retransmission.
I Frame Avg Video Bw	The average bandwidth of I-frame video content transmitted, in bit-s/second, for all currently active streams.
P Frame Avg Video Bw	The average bandwidth of P-frame video content transmitted, in bit-s/second, for all currently active streams.
B Frame Avg Video Bw	The average bandwidth of B-frame video content transmitted, in bit-s/second, for all currently active streams.
Scene Avg Detail Level	The average amount of detail in the currently active streams, expressed on a scale of 0 (little detail) to 100 (maximum detail).
Scene Avg Panning Level	The average amount of panning in the currently active streams, expressed on a scale of 0 (no panning) to 100 (continuous panning).
Scene Avg Motion Level	The average amount of motion in the currently active streams, expressed on a scale of 0 (no motion) to 100 (continuous motion).

## Per-stream Video Quality Statistics

The table below lists the IxLoad IPTV / Video client per-stream video quality statistics.

These statistics measure the video and audio quality of a single stream.



**Note:** Relative and Absolute MOS scores are described in Mean Opinion Score (MOS).

Statistic	Description
TVQM Avg Video Bw	The average video bandwidth, in bits/second, excluding transport packet header overhead and error correction/retransmission.
TVQM Peak Video Bw	The peak video bandwidth, in bits/second, measured during a one second window, excluding transport packet header overhead and error correction/retransmission.
TVQM Packets Received	Number of stream video transport packets received properly for playout.
TVQM Packets Discarded	Number of stream video transport packets discarded.
TVQM Frame Rate	The video frame rate, in frames per one thousand seconds – e.g. 29,970 equals 29.97 frames per second.
TVQM Avg Abs MOSV	The average absolute video stream MOS over the stream duration.
TVQM Avg Rel MOSV	The average relative video stream MOS over the stream duration.
TVQM Avg MOSA	Absolute audio MOS, averaged from stream start to the current time.
TVQM Avg MOSAV	The average audio/video stream MOS over the stream duration.
TVQM Int Avg Abs MOSV	Absolute MOS, averaged over the most recent statistics Update Interval (you can configure the Update Interval is on the video client Statistics Options tab).
TVQM Int Avg Rel MOSV	Relative MOS averaged over the most recent statistics Update Interval (you can configure the Update Interval on the video client Statistics Options tab).
TVQM I Frames Rcvd	The number of video I-frames received.

TVQM P Frames Rcvd	The number of video P-frames received.
TVQM B Frames Rcvd	The number of video B-frames received.
TVQM I Frames Impaired	Number of I-frames impaired due to packet loss or discards.
TVQM P Frames Impaired	Number of P-frames impaired due to packet loss and/or discards. This does not include frames impaired due to error propagation through temporal reference.
TVQM B Frames Impaired	Number of B-frames impaired due to packet loss and/or discards. This does not include frames impaired due to error propagation through temporal reference.
TVQM Detail Level	The instantaneous amount of detail, expressed on a scale of 0 (little detail) to 100 (maximum detail).
TVQM Pan- ning Level	The instantaneous amount of panning, expressed on a scale of 0 (no panning) to 100 (continuous panning).
TVQM Motion Level	The instantaneous amount of motion, expressed on a scale of 0 (no motion) to 100 (continuous motion).
TVQM Inter I Frame Gap	The average gap, in frames, between I frames (excluding the I-frames)
TVQM PPDV	The stream transport Packet-to-Packet Delay Variation (RFC3550), in milliseconds.

## Packet Transport Conditional Statistics

The table below lists the IxLoad IPTV / Video client video quality packet transport QoE Detective statistics.

The QoE Detective column indicates the views in which a statistic is available:

**IP:** per-IP view

**User:** per-User view

**VLAN:** per-VLAN view

**All:** all views

Statistic	QoE Detective	Description
JB Packets Rcvd	User	The number of stream transport packets received.
JB Packets Lost	User	The number of stream transport packets lost in the network.
JB Packets Discarded	User	The number of stream transport packets discarded by the endpoint due to late arrival.

## Video Description Conditional Statistics

The table below lists the IxLoad IPTV / Video client video quality video description QoE Detective statistics.

The QoE Detective column indicates the views in which a statistic is available:

**IP:** per-IP view

**User:** per-User view

**VLAN:** per-VLAN view

**All:** all views

Statistic	QoE Detective	Description
Codec Type	User	The video CODEC type for the video stream.
GOP Structure	User	The GOP structure expressed as a series of 'I', 'B', 'P' characters describing the frame type series in the structure.
Avg GOP Length	User	The average GOP length, in frames.
Avg Inter I Frame Gap (Frames)	User	The average gap, in frames, between I frames (excluding the I-frames)
Frame Rate	User	The video frame rate, in frames per one thousand seconds – e.g. 29,970 equals 29.97 frames per second.

## Video Perceptual Quality Conditional Statistics

The table below lists the IxLoad IPTV / Video client video perceptual quality statistics.

The QoE Detective column indicates the views in which a statistic is available:

**IP:** per-IP view

**User:** per-User view

**VLAN:** per-VLAN view

**All:** all views

Statistic	QoE Detective	Description
Avg Absolute MOS V	User	The average absolute video stream MOS over the stream duration.
Avg Relative MOS V	User	The average relative video stream MOS over the stream duration.
Avg MOS A	User	The average audio stream MOS over the stream duration.
Avg MOS AV	User	The average audio/video stream MOS over the stream duration.
Interval Absolute MOS V	User	The absolute stream instantaneous video MOS sampled at the end of the interval configured on the video client Statistics Options tab.
Interval Relative MOS V	User	The relative stream instantaneous video MOS sampled at the end of the interval configured on the video client Statistics Options tab.
EPSNR (ATIS)	User	The Estimated Peak Signal to Noise Ratio (PSNR) calculated according to ATIS specifications.

## Video Frame Conditional Statistics

The table below lists the IxLoad IPTV / Video client video quality video frame QoE Detective statistics.

The QoE Detective column indicates the views in which a statistic is available:



**IP:** per-IP view

**User:** per-User view

**VLAN:** per-VLAN view

**All:** all views

Statistic	QoE Detective	Description
I Frames Rcvd	User	The number of video I-frames received.
I Frames Impaired	User	Number of I-frames impaired due to packet loss or discards.
P Frames Rcvd	User	The number of video P-frames received.
P Frames Impaired	User	Number of P-frames impaired due to packet loss and/or discards. This does not include frames impaired due to error propagation through temporal reference.
B Frames Rcvd	User	The number of video B-frames received.
B Frames Impaired	User	Number of B-frames impaired due to packet loss and/or discards. This does not include frames impaired due to error propagation through temporal reference.
SI Frames Rcvd	User	The number of video SI-frames received.
SI Frames Impaired	User	The number of video SI-frames impaired by packet loss or discard.
SP Frames Rcvd	User	The number of video SP-frames received.
SP Frames Impaired	User	The number of video SP-frames impaired by packet loss or discard.
I Frame Pkts Rcvd	User	The number of transport packets received containing video I-frame information.
I Frame Pkts Lost	User	The number of transport packets lost containing video I-frame information.

I Frame Pkts Discarded	User	The number of transport packets discarded due to late arrival containing video I-frame information.
P Frame Pkts Rcvd	User	The number of transport packets received containing video P-frame information.
P Frame Pkts Lost	User	The number of transport packets lost containing video P-frame information.
P Frame Pkts Discarded	User	The number of transport packets discarded due to late arrival containing video P-frame information.
B Frame Pkts Rcvd	User	The number of transport packets received containing video B-frame information.
B Frame Pkts Lost	User	The number of transport packets lost containing video B-frame information.
B Frame Pkts Discarded	User	The number of transport packets discarded due to late arrival containing video B-frame information.

## Bandwidth Conditional Statistics

The table below lists the IxLoad IPTV / Video client video quality bandwidth QoE Detective statistics. These statistics pertain to the distribution of I, B, P, SI and SP video frame and audio frame bandwidth consumption.

The QoE Detective column indicates the views in which a statistic is available:

- IP:** per-IP view
- User:** per-User view
- VLAN:** per-VLAN view
- All:** all views

Statistic	QoE Detective	Description
-----------	---------------	-------------

Avg Video Bw (Kbps)	User	The average video bandwidth, in bits/ second, measured during a one second window, excluding transport packet header overhead and error correction/retransmission.
Peak Video Bw (Kbps)	All	The peak video bandwidth, in bits/second, measured during a one second window, excluding transport packet header overhead and error correction/retransmission.
Avg Audio Bw (Kbps)	User	The average audio bandwidth, in bits/ second, measured during a one second window, excluding transport packet header overhead and error correction/retransmission.
Peak Audio Bw (Kbps)	All	The peak audio bandwidth, in bits/second, measured during a one second window, excluding transport packet header overhead and error correction/retransmission.
I Frame Avg Video Bw (Kbps)	User	The average bandwidth of I-frame transport packets received, in bit-s/second.
I Frame Peak Video Bw (Kbps)	All	The maximum bandwidth of I-frame transport packets received, in bit-s/second.
P Frame Avg Video Bw (Kbps)	User	The average bandwidth of P-frame transport packets received, in bit-s/second.
P Frame Peak Video Bw (Kbps)	All	The maximum bandwidth of P-frame transport packets received, in bit-s/second.
B Frame Avg Video Bw (Kbps)	User	The average bandwidth of B-frame transport packets received, in bit-s/second.
B Frame Peak Video Bw (Kbps)	All	The maximum bandwidth of B-frame transport packets received, in bit-s/second.

## Frame Jitter Conditional Statistics

The table below lists the IxLoad IPTV / Video client video quality video jitter QoE Detective statistics. These statistics contain the video frame jitter and transmission delay statistics.

The QoE Detective column indicates the QoE Detective views in which a statistic is available:

**IP:** per-IP view

**User:** per-User view

**VLAN:** per-VLAN view

**All:** all views

Statistic	QoE Detective	Description
Frame Inter Arrival Jitter (ms)	User	The average frame inter-arrival jitter, in milliseconds. The inter-arrival jitter is computed relative to the expected arrival time based on the frame rate.
I Frame Inter Arrival Jitter (ms)	User	The average I-frame inter-arrival jitter, in milliseconds. The inter-arrival jitter is computed relative to the expected arrival time based on the frame rate.

## Packet Jitter Conditional Statistics

The table below lists the IxLoad IPTV / Video client video quality packet jitter QoE Detective statistics. These statistics provide a variety of statistics about the transport packet jitter experienced throughout the duration of the stream.

The QoE Detective column indicates the views in which a statistic is available:

**IP:** per-IP view

**User:** per-User view

**VLAN:** per-VLAN view

**All:** all views

Statistic	QoE Detective	Description
-----------	---------------	-------------

PPDV (ms)	User	The stream transport Packet-to-Packet Delay Variation (RFC3550), in milliseconds.
Max PPDV (ms)	All	The maximum stream transport Packet-to-Packet Delay Variation (RFC3550), in milliseconds.

## Scene Analysis Conditional Statistics

The table below lists the IxLoad IPTV / Video client TVQM Scene Analysis QoE Detective statistics. These statistics describe the scene types and content detected within the video stream.

The QoE Detective column indicates the views in which a statistic is available:

**IP:** per-IP view

**User:** per-User view

**VLAN:** per-VLAN view

**All:** all views

Statistic	QoE Detective	Description
Scene Detail Level	User	The instantaneous amount of detail, expressed on a scale of 0 (little detail) to 100 (maximum detail).
Scene Motion Level	User	The instantaneous amount of motion, expressed on a scale of 0 (no motion) to 100 (continuous motion).
Scene Panning Level	User	The instantaneous amount of panning, expressed on a scale of 0 (no panning) to 100 (continuous panning).

## IPTV / Video Server Statistics



**Note:** The video servers do not have a Ramp Down period; they stream for the duration of the test and then stop as quickly as possible at the end of the test. Therefore, the statistics may show the server bit rates still above 0 (zero) shortly after the end of the test.

The table below lists the IxLoad Video server statistics.

The QoE Detective column indicates the views in which a statistic is available:

**IP:** per-IP view

**User:** per-User view

**VLAN:** per-VLAN view

**All:** all views

Statistic	QoE Detective	Description
Total Streams Playing		Total number of video streams playing on the video server.
No of Multicast Streams Playing		Number of multicast (broadcast-type) streams playing.
No of Unicast Streams Playing		Number of unicast streams playing.
No of VoD Streams Active	IP, VLAN	Number of video-on-demand streams active.
No of VoD Streams Playing	IP, VLAN	Number of video-on-demand streams playing.
No of VoD Streams Paused	IP, VLAN	Number of video-on-demand streams currently paused.
No of Multicast Streams Played	IP, VLAN	Number of multicast (broadcast-type) streams played.
No of VoD Streams Played	IP, VLAN	Number of video-on-demand streams played.
Total Streaming Bit Rate		Aggregate bit rate of all video streams playing on the server.
Multicast Streams Bit Rate		Bit rate of multicast (broadcast-type) video streams playing on the server.

Unicast Streams Bit Rate		Bit rate of unicast video streams playing on the server.
VoD Streams Bit Rate	IP, VLAN	Bit rate of video-on-demand video streams playing on the server.
No of IPTV D Server Requests Received	IP, VLAN	Number of requests received by the D server.
No of IPTV V Server Requests Received	IP, VLAN	Number of requests received by the V server.
No of IPTV D Server Requests Successful	IP, VLAN	Number of requests received by the D server that were successful.
No of IPTV V Server Requests Successful	IP, VLAN	Number of requests received by the V server that were successful.
No of IPTV D Server Requests Failed	IP, VLAN	Total number of requests received by the D server that failed for all reasons.
No of IPTV V Server Requests Failed	IP, VLAN	Total number of requests received by the V server that failed for all reasons.
No of IPTV D Server Requests Failed for Bandwidth	IP, VLAN	Number of requests received by the D server that failed because not enough bandwidth was available on the server.
No of IPTV V Server Requests Failed for Bandwidth	IP, VLAN	Number of requests received by the V server that failed because not enough bandwidth was available on the server.
No of IPTV D Server Requests Failed for Port Overload	IP, VLAN	Number of requests received by the D server that failed because the Ixia port that the server was running on was oversubscribed.
No of IPTV V Server Requests Failed for Port Overload	IP, VLAN	Number of requests received by the V server that failed because the Ixia port that the server was running on was oversubscribed.
No of IPTV D Server Requests Failed for Other Reasons	IP, VLAN	Number of requests received by the D server that failed for reasons other than lack of bandwidth or port overload.
No of IPTV V Server Requests Failed for Other Reasons	IP, VLAN	Number of requests received by the V server that failed for reasons other than lack of bandwidth or port overload.

No of IPTV Active A Server Streams Playing	- -	Number of streams available on the A server that are currently playing.
No of IPTV Active D Server Streams Playing	IP, VLAN	Number of streams available on the D server that are currently playing.
No of IPTV Active V Server Streams	IP, VLAN	Number of streams available on the V server.
No of IPTV Active V Server Streams Playing	IP, VLAN	Number of streams on the V server that are currently playing.
No of IPTV Active V Server Streams Paused	IP, VLAN	Number of streams on the V server that are currently paused.
A Server Streams Bit Rate	- -	Combined bit rate of all streams currently playing on the A server.
D Server Streams Bit Rate	IP, VLAN	Combined bit rate of all streams currently playing on the D server.
V Server Streams Bit Rate	IP, VLAN	Combined bit rate of all streams currently playing on the V server.
IPTV Total Streaming Bit Rate	- -	Combined bit rate of all streams currently playing on the A, D, and V servers.
RTSP Presentations Received	IP, VLAN	Number of RTSP Presentation requests received by the servers.
RTSP Presentations Successful	IP, VLAN	Number of RTSP Presentation requests that succeeded.
RTSP Presentations Failed	IP, VLAN	Number of RTSP Presentation requests that failed.
RTSP Bytes Sent	IP, VLAN	Number of RTSP-related bytes (commands and responses) sent by the server.
RTSP Bytes Received	IP, VLAN	Number of RTSP-related bytes (commands and responses) received by the server.
RTSP Packets Sent	IP, VLAN	Number of RTSP packets sent by the server.



RTSP Packets Received	IP, VLAN	Number of RTSP packets received the server.
RTSP Play Latency (ms)	All	Average amount of time elapsed, in milliseconds, between the time the server received a PLAY request and the time it transmitted the first byte of the video stream. Note for Tcl API users: This is a weighted statistic. If you are using this statistic in a Tcl script, use the <i>kWeightedAverage</i> aggregation type.
RTSP Commands Received	IP, VLAN	Total number of RTSP commands of all types received by the server.
RTSP DESCRIBE Received	IP, VLAN	Total number of RTSP DESCRIBE commands received by the server.
RTSP SETUP Received	IP, VLAN	Total number of RTSP SETUP commands received by the server.
RTSP PLAY Received	IP, VLAN	Total number of RTSP PLAY commands received by the server.
RTSP PAUSE Received	IP, VLAN	Total number of RTSP PAUSE commands received by the server.
RTSP TEARDOWN Received	IP, VLAN	Total number of RTSP TEARDOWN commands received by the server.
RTSP Response Codes Sent (2xx)	IP, VLAN	Number of 200-range (Success) responses sent. A 200-range response indicates that the action was successfully received, understood, and accepted.
RTSP Response Codes Sent (3xx)	IP, VLAN	Number of 300-range (Redirection) responses sent. A 300-range response indicates that further action must be taken in order to complete the request.
RTSP Response Codes Sent (4xx)	IP, VLAN	Number of 400-range (Client Error) responses sent. A 400-range response indicates that the request contains bad syntax or cannot be fulfilled.
RTSP Response Codes Sent (5xx)	IP, VLAN	Number of 500-range (Server Error) responses sent. A 500-range response indicates that the server failed to fulfill an apparently valid request.
RTSP Response Codes Sent (6xx-1xxx)	IP, VLAN	Number of 600- to 1000-range responses sent.

Total Bytes Sent	- -	Total bytes sent by the server.
Total Packets Sent	- -	Total packets sent by the server.
Tx Jitter (ns)	- -	Variation in packet transmission times, in nanoseconds.
Tx Packets Dropped	- -	Number of packets dropped before transmission.

# iSCSI

This section describes the iSCSI Tcl API objects.

## API Overview

The IxLoad iSCSI API consists of the iSCSI Client Agent, its commands, and a iSCSI Server Agent.

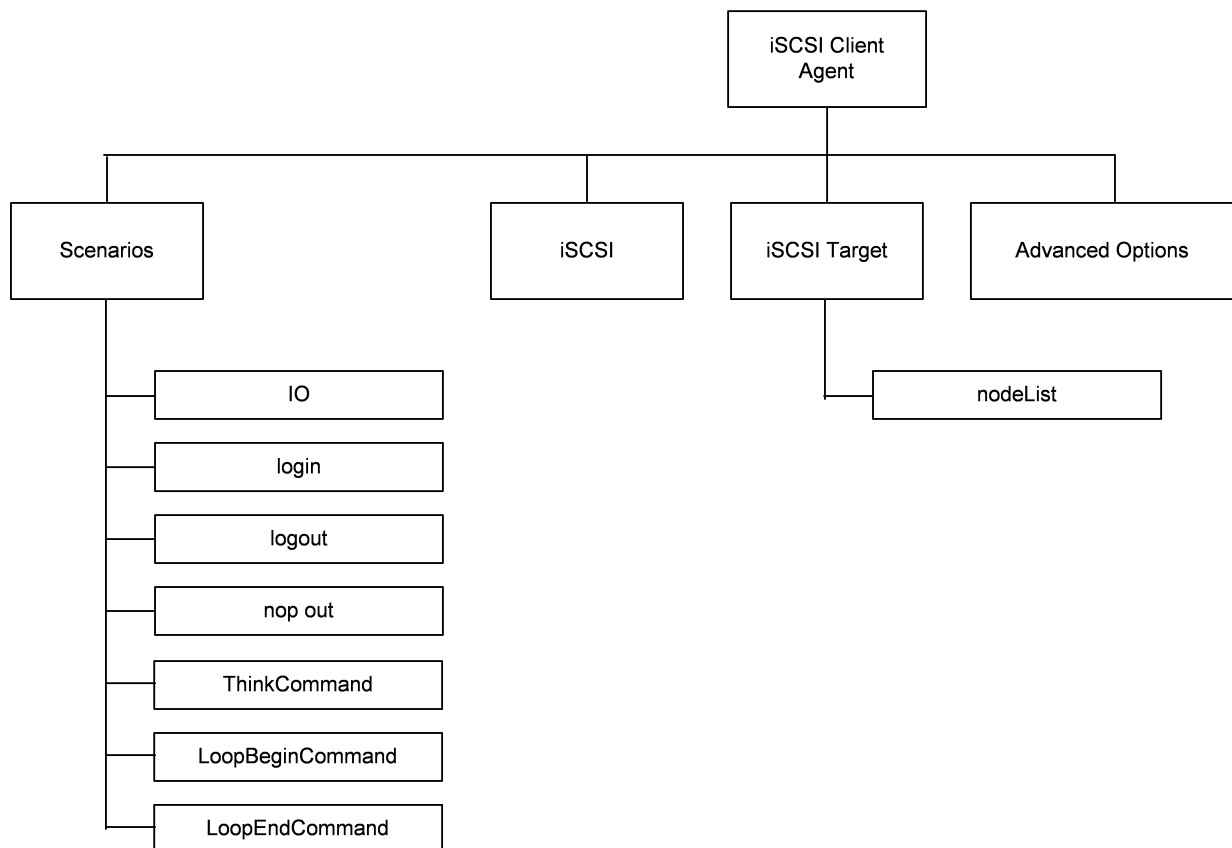

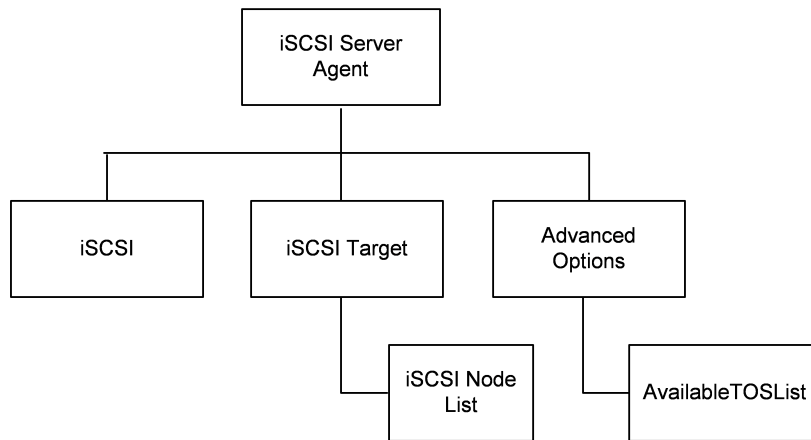

---

## iSCSI Client Agent

<protocol> client agent - create a <protocol> client agent

### SYNOPSIS

```
set Activity_<protocol>Client1 [$Traffic1_Network1 activityList.appendItem \  
-protocolAndType                "<protocol> Client" ]
```

### DESCRIPTION

A <protocol> client agent is added to the activityList object. The activityList object is added to the ixNetTraffic object using the appendItem subcommand from the ixConfigSequenceContainer command.

### SUBCOMMANDS

None.

### OPTIONS

The options for this command are configured and read using the standard config, cget, and getOptions subcommands defined in the ixConfig command.

### STATISTICS

### EXAMPLE

```
set Activity_<protocol>Client1 [$Traffic1_Network1 activityList.appendItem \  
-protocolAndType                "<protocol> Client" ]
```

### SEE ALSO

[ixNetTraffic](#)

## **iSCSI Client Commands**

This section lists the iSCSI client agent's commands.

---

## iscsi

iscsi - configure the basic properties of an iSCSI client agent

### SYNOPSIS

```
$Activity_iSCSIClient1 agent.pm.iscsi.config
```

### DESCRIPTION

This object configures the basic properties of an iSCSI client agent.

### SUBCOMMANDS

None.

### OPTIONS

enableAlias

Enable use of an alias during a session. Default = true.

immediateData

Indicate if ImmediateData is supported by Initiator. 0 = No, 1 = Yes, Default = "0".

initialR2T

Indicate if R2T is supported by Initiator. 0 = No, 1 = Yes, Default = "0".

initiatorAlias

Initiator alias to be used during a session. Min length = 0, Max length = 50, Default = "ixiacom-iscsi".

firstBurstLength

Maximum payload bytes of Unsolicited Data within an iSCSI sequence. Min = "512", Max = "16777215", Default = "65535".

maxRecvDataSegmentLength

Maximum Data Segment Length the Initiator can receive in an iSCSI PDU. Min = "512", Max = "16777215", Default="8192".

headerDigest

Enable Header Digest support. Min = "0", Max = "1", Default = "0".

initiatorName

initiator Name to be used during a session. Min Length = "10", Max Length = "255", Default = "iqn.2010-11.com.ixia.ixload:initiator-iscsi".

dataDigest

Enable Data Digest support. Min = "0", Max = "1", Default = "0".

maxBurstLength

Maximum payload bytes of Solicited Data within an iSCSI sequence. Min = "512", Max = "16777215", Default = "262144".

### EXAMPLE

```
$Activity_iSCSIClient1 agent.pm.iscsi.config \  
-enableAlias           true \  
-immediateData        0 \  
-initialR2T           1 \  
-initiatorAlias       "ixiacom-iscsi" \  
-firstBurstLength     65535 \  
-maxRecvDataSegmentLength 8192 \  
-headerDigest         0 \  
-initiatorName        "iqn.2010-11.com.ixia.ixload:initiator-iscsi" \  
-dataDigest           0 \  
-maxBurstLength       262144
```

### SEE ALSO



## iscsiTarget

iscsiTarget - configure the number of targets for an iSCSI client or server.

### SYNOPSIS

```
$Activity_iSCSIClient1 agent.pm.iscsiTarget.config
```

```
$Activity_iSCSIServer1 agent.pm.iscsiTarget.config
```

### DESCRIPTION

This object configures the number of targets for an iSCSI client or server. These data structures enable tree traversal, insertion and deletion operations.

### SUBCOMMANDS

None.

### OPTIONS

```
numberOfLuns
```

Number of LUNs in an activity.

```
maxSelfId
```

Assigns a unique label to each node under the tree.

```
numberOfTargets
```

Number of targets in an activity.

```
numberOfPortals
```

Number of portals in an activity.

```
maxPortalLabelId
```

Assigns a unique label to each portal (for example, TP1...TPn).

```
maxTargetLabelId
```

Assigns a unique label to each target (for example, TG1...TGn) under a portal.

### EXAMPLE (client)

```
$Activity_iSCSIClient1 agent.pm.iscsiTarget.config \
```

```
-numberOfLuns          1 \
```

```
-maxSelfId             4 \
```

-numberOfTargets            1 \  
-numberOfPortals            1 \  
-maxPortalLabelId           2 \  
-maxTargetLabelId          1

**SEE ALSO**

## advOptions

advOptions - configure the advanced options of an iSCSI client agent

### SYNOPSIS

```
$Activity_iSCSIClient1 agent.pm.advOptions.config
```

### DESCRIPTION

This object configures the advanced properties of an iSCSI client agent.

### SUBCOMMANDS

None.

### OPTIONS

enableTOS

Enables use of TOS bits in packets from the initiator. Default = 0.

commandCompletionTimeout

Time to wait for a command to be completed. Min = "1", Max = "2147483", Default = "120".

enableEsm

Enable use of ESM. Default = 0.

ipPreference

IP version (IPv4/IPv6) preference.

Choice	Description
0	IPv4
1	IPv6
2	Both, IPv4 first
3	Both, IPv6 first

vlan\_priority

VLAN priority. Min = "0", Max = "7", Default="0".

typeOfService

Type of service string, from availableTosList.

esm

MSS size. Min = "64", Max = "1460", Default = "1460".

`enableVlanPriority`

Enables setting of the VLAN priority. Default = "0".

### EXAMPLE

```
$Activity_iSCSIClient1 agent.pm.advOptions.config \
```

```
-enableTOS                false \  
-commandCompletionTimeout 120 \  
-enableEsm                false \  
-ipPreference             2 \  
-vlan_priority            0 \  
-typeOfService            "Best Effort (0x0)" \  
-esm                      1460 \  
-enableVlanPriority        false
```

### SEE ALSO

[ixNetTraffic](#)

---

## iSCSI Server Agent

iSCSI server agent - create an iSCSI server agent

### SYNOPSIS

```
set Activity_iSCSIServer1 [$Traffic2_Network2 activityList.appendItem \  
-protocolAndType          "iscsi Server" ]
```

### DESCRIPTION

An iSCSI server agent is added to the activityList object. The activityList object is added to the ixNetTraffic object using the appendItem subcommand from the ixConfigSequenceContainer command.

### SUBCOMMANDS

None.

### OPTIONS

The options for this command are configured and read using the standard `config`, `cget`, and `getOption` subcommands defined in the `ixConfig` command.

### STATISTICS

### EXAMPLE

```
set Activity_iSCSIServer1 [$Traffic2_Network2 activityList.appendItem \  
-protocolAndType          "iscsi Server" ]
```

### SEE ALSO

## iscsi

iscsi - configure the basic properties of an iSCSI client agent

### SYNOPSIS

```
$Activity_iSCSIClient1 agent.pm.iscsi.config
```

### DESCRIPTION

This object configures the basic properties of an iSCSI client agent.

### SUBCOMMANDS

None.

### OPTIONS

userName

User name. minLength = "1" maxLength="256" default="someuser".

enableDataInegrity

Enable Data Integrity support. Default = false.

password

Password for user name. minLength = "1" maxLength="128" default="secret".

payloadType

Payload type. One of the following:

Choice	Description
0 (default)	Dummy
1	Synthetic Pattern Generator

enableAlias

Enable use of an alias during a session. Default = true.

immediateData

Indicate if ImmediateData is supported by Initiator. 0 = No, 1 = Yes, Default = "0".

initialR2T

Indicate if R2T is supported by Initiator. 0 = No, 1 = Yes, Default = "0".

initiatorAlias

Initiator alias to be used during a session. Min length = 0, Max length = 50, Default = "ixiacom-iscsi".

firstBurstLength

Maximum payload bytes of Unsolicited Data within an iSCSI sequence. Min = "512", Max = "16777215", Default = "65535".

maxRecvDataSegmentLength

Maximum Data Segment Length the Initiator can receive in an iSCSI PDU. Min = "512", Max = "16777215", Default="8192".

headerDigest

Enable Header Digest support. Min = "0", Max = "1", Default = "0".

initiatorName

initiator Name to be used during a session. Min Length = "10", Max Length = "255", Default = "iqn.2010-11.com.ixia.ixload:initiator-iscsi".

authenticationMethod

Authentication method. One of the following:

Choice	Description
0 (default)	None
1	CHAP
2	CHAP, None

dataDigest

Enable Data Digest support. Min = "0", Max = "1", Default = "0".

maxBurstLength

Maximum payload bytes of Solicited Data within an iSCSI sequence. Min = "512", Max = "16777215", Default = "262144".

## EXAMPLE

```
$Activity_iSCSIClient1 agent.pm.iscsi.config \
-enableAlias          true \
-immediateData        0 \
-initialR2T           1 \
-initiatorAlias       "ixiacom-iscsi" \
-firstBurstLength     65535 \
```

```
-maxRecvDataSegmentLength      8192 \  
-headerDigest                   0 \  
-initiatorName                  "iqn.2010-11.com.ixia.ixload:initiator-iscsi" \  
-dataDigest                     0 \  
-maxBurstLength                 262144
```

**SEE ALSO**



## iscsiTarget

iscsiTarget - configure the number of targets for an iSCSI client or server.

### SYNOPSIS

```
$Activity_iSCSIClient1 agent.pm.iscsiTarget.config
```

```
$Activity_iSCSIServer1 agent.pm.iscsiTarget.config
```

### DESCRIPTION

This object configures the number of targets for an iSCSI client or server. These data structures enable tree traversal, insertion and deletion operations.

### SUBCOMMANDS

None.

### OPTIONS

```
numberOfLuns
```

Number of LUNs in an activity.

```
maxSelfId
```

Assigns a unique label to each node under the tree.

```
numberOfTargets
```

Number of targets in an activity.

```
numberOfPortals
```

Number of portals in an activity.

```
maxPortalLabelId
```

Assigns a unique label to each portal (for example, TP1...TPn).

```
maxTargetLabelId
```

Assigns a unique label to each target (for example, TG1...TGn) under a portal.

### EXAMPLE (client)

```
$Activity_iSCSIClient1 agent.pm.iscsiTarget.config \
```

```
-numberOfLuns          1 \
```

```
-maxSelfId             4 \
```

-numberOfTargets            1 \  
-numberOfPortals            1 \  
-maxPortalLabelId           2 \  
-maxTargetLabelId          1

**SEE ALSO**

## advOptions

advOptions - configure the advanced options of an iSCSI client agent

### SYNOPSIS

```
$Activity_iSCSIClient1 agent.pm.advOptions.config
```

### DESCRIPTION

This object configures the advanced properties of an iSCSI server agent.

### SUBCOMMANDS

None.

### OPTIONS

enableTOS

Enables use of TOS bits in packets from the initiator. Default = 0.

enableEsm

Enable use of ESM. Default = 0.

listeningPort

Port that the server listens on for new iSCSI connections. Min="1", Max="65535", Default="3260".

vlan\_priority

VLAN priority. Min = "0", Max = "7", Default="0".

typeOfService

Type of service string, from availableTosList.

esm

MSS size. Min = "64", Max = "1460", Default = "1460".

enableVlanPriority

Enables setting of the VLAN priority. Default = "0".

### EXAMPLE

```
$Activity_iSCSIServer1 agent.pm.advOptions.config \
```

```
-enableTOS                false \
```

```
-enableEsm                false \
```

```
-listeningPort            3260 \
```

```
-vlan_priority          0 \  
-typeOfService         "Best Effort (0x0)" \  
-esm                   1460 \  
-enableVlanPriority    false
```

**SEE ALSO**

# IxIO

This section describes the IxIO Tcl API objects.

## API Overview

The IxLoad IxIO API consists of the IxIO Client Agent and its commands

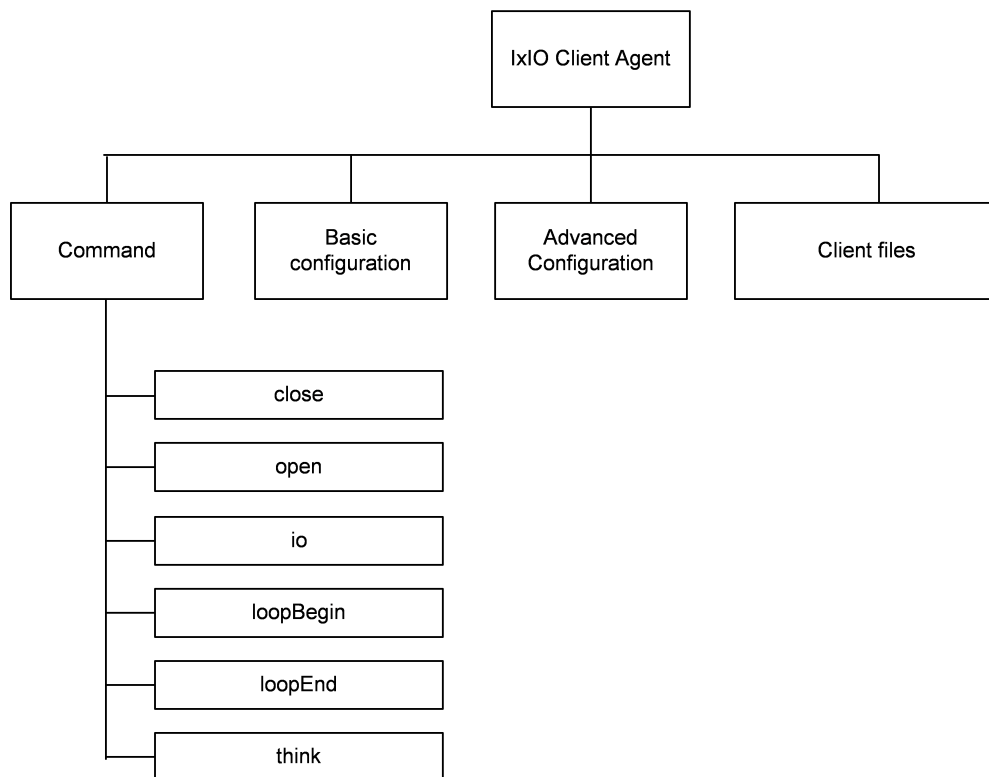

## IxIO Client Agent

IxIO client agent - create an IxIO client agent

### SYNOPSIS

```
set Activity_IxIOClient1 [$Traffic1_Network1 activityList.appendItem \  
-protocolAndType          "IxIO Client" ]
```

### DESCRIPTION

An IxIO client agent is added to the activityList object. The activityList object is added to the ixNetTraffic object using the appendItem subcommand from the ixConfigSequenceContainer command.

### SUBCOMMANDS

None.

### OPTIONS

The options for this command are configured and read using the standard config, cget, and getOptions subcommands defined in the ixConfig command.

### STATISTICS

### EXAMPLE

```
set Activity_IxIOClient1 [$Traffic1_Network1 activityList.appendItem \  
-protocolAndType          "IxIO Client" ]
```

### SEE ALSO

[ixNetTraffic](#)

## client file list

client file list - configure the list of files for an IxIO client agent

### SYNOPSIS

```
$Activity_IxIOClient1 agent.pm.clientFiles.clientFileList.appendItem
```

### DESCRIPTION

This object configures the list of files used by an IxIO client agent.

The options for this command are configured and read using the standard `config`, `cget`, and `getOption` subcommands defined in the `ixConfig` command. Unless otherwise described, no values are returned and an exception is raised for any error found.

### SUBCOMMANDS

None.

### OPTIONS

`id`

Name of the file list. Default = "ClientFile".

`offsetStart`

Start of the location to read or write. Default = 0.

`offsetEnd`

End of the location to read or write. Default = 8096.

`fileType`

File type. Default = "logical".

`mntPath`

Path for drive. "E:" \

`fileName`

File name. Default = "file0".

### EXAMPLE

```
$Activity_IxIOClient1 agent.pm.clientFiles.clientFileList.appendItem \
-id                "ClientFile" \
-offsetStart       0 \
-offsetEnd         8096 \
```

-fileType               "logical" \  
-mntPath                "E:" \  
-fileName                "file0"

**SEE ALSO**

[ixNetTraffic](#)



---

## advanced configuration

Advanced config - configure the advanced properties of an IxIO client agent

### SYNOPSIS

```
$Activity_IxIOClient1 agent.pm.advancedConfiguration.config
```

### DESCRIPTION

This object configures the advanced properties of an IxIO client agent.

### SUBCOMMANDS

None.

### OPTIONS

`ioQueueDepth`

Number of IO commands to queue per user. Default = 1.

`ioQueueLimitGlobal`

Global limit on the number of IO commands to be queued. Default = 0.

`enableDataBufferValidation`

Enable confirmation of the data read or writtern. Default = false.

### EXAMPLE

```
$Activity_IxIOClient1 agent.pm.advancedConfiguration.config \
```

```
-ioQueueDepth          1 \
```

```
-ioQueueLimitGlobal    0 \
```

```
-enableDataBufferValidation  false
```

### SEE ALSO

[ixNetTraffic](#)

## drive list

driveList - configure the list of drives for an IxIO client agent

### SYNOPSIS

```
$Activity_IxIOClient1 agent.pm.basicConfiguration.driveList.appendItem
```

### DESCRIPTION

This object configures the list of drives for an IxIO client agent.

### SUBCOMMANDS

None.

### OPTIONS

id

Name of the drive to mount. Default = "TargetDrive".

mntCommand

Command to mount drive. Default = (none).

mntPath

Path of mounted drive. Default = (none).

### EXAMPLE

```
$Activity_IxIOClient1 agent.pm.basicConfiguration.driveList.appendItem \  
-id                "TargetDrive" \  
-mntCommand        "mount //host/folder /mnt/remote" \  
-mntPath           "E:"
```

### SEE ALSO

[ixNetTraffic](#)

## IxIO Client Commands

This section lists the IxIO client agent's commands.

### io

io command

#### SYNOPSIS

```
$Activity_IxIOClient1 agent.pm.scenarios.appendItem \  
-commandType "IO"
```

#### DESCRIPTION

The io command reads or writes data on the server.

#### SUBCOMMANDS

None.

#### OPTIONS

commandType

Type of IxIO command. Default = "IO" \  
fileHandle

Handle to be used to read or write. Default = "ih\_<drive><file>"

cmdName

Name of the IxIO command. Default = "I/O 1"

#### STATISTICS

#### EXAMPLE

```
$Activity_IxIOClient1 agent.pm.scenarios.appendItem \  
-commandType "IO" \  
-fileHandle "ih_E:/file0" \  
-cmdName "I/O 1" \  
$Activity_IxIOClient1 agent.pm.scenarios(0).ioParameterSetList.clear \  
$Activity_IxIOClient1 agent.pm.scenarios(0).ioParameterSetList.appendItem \  

```

```
-id "IoParameterSet" \  
-weight 100 \  
-burst 1 \  
-buffer 1 \  
-align 0 \  
-delay 0 \  
-readPercentage 50 \  
-reply 0 \  
-position 0
```

## **SEE ALSO**

## **ioParameterSetList**

ioParameterSetList - list of parameters for an io command.

## **SYNOPSIS**

```
$Activity_IxIOClient1 agent.pm.scenarios(0).ioParameterSetList.appendItem \  
-id "IoParameterSet"
```

## **DESCRIPTION**

ioParameterSetList configures the list of parameters for an io command.

## **SUBCOMMANDS**

None.

## **OPTIONS**

id

Name of this parameter set list. Default = "IoParameterSet".

weight

Percentage of times this profile will be used when the IO command is executed during the test. Default = 100.

burst

Number of operations to issue at the same time. Default = 1.

**buffer**

Amount of data to read or write at one time. Default = 1.

**align**

Aligns the buffer size with the sector size used on the target device. Default = 0.

**delay**

Amount of data to read or write at one time. Default = 0.

**readPercentage**

Percent of executions of the IO command that will be reads. Default = 50.

**reply**

Performs the reverse of the operation performed by the profile. Default = 0 \

**position**

Frequency with which the command selects a random location to perform the read or write operation. Default = 0.

**EXAMPLE**

```
$Activity_IxIOClient1 agent.pm.scenarios(0).ioParameterSetList.clear
$Activity_IxIOClient1 agent.pm.scenarios(0).ioParameterSetList.appendItem \
-id "IoParameterSet" \
-weight 100 \
-burst 1 \
-buffer 1 \
-align 0 \
-delay 0 \
-readPercentage 50 \
-reply 0 \
-position 0
```

**SEE ALSO****open**

open command

**SYNOPSIS**

```
$Activity_IxIOClient1 agent.pm.scenarios.appendItem \  
-commandType "OPEN"
```

**DESCRIPTION**

The open command opens a file.

**SUBCOMMANDS**

None.

**OPTIONS**

commandType

Type of IxIO command. Default = "OPEN".

fileHandle

Handle to be used to open file with. Default = "handle<n>".

file

Path of file to be opened. Default = (none).

cmdName

Name of the IxIO command. Default = "OPEN <n>".

**EXAMPLE**

```
$Activity_IxIOClient1 agent.pm.scenarios.appendItem \  
-commandType "OPEN" \  
-fileHandle "handle2" \  
-file "E:/file0" \  
-cmdName "OPEN 2"
```

**SEE ALSO****close**

close command

**SYNOPSIS**

```
$Activity_IxIOClient1 agent.pm.scenarios.appendItem \  

```

-commandType "CLOSE"

## DESCRIPTION

The close command closes a file.

## SUBCOMMANDS

None.

## OPTIONS

commandType

Type of IxIO command. Default = "CLOSE".

fileHandle

Handle to be used to close file with. Default = "handle<n>".

cmdName

Name of the IxIO command. Default = "CLOSE <n>".

## EXAMPLE

```
$Activity_IxIOClient1 agent.pm.scenarios.appendItem \
```

```
-commandType "CLOSE" \
```

```
-fileHandle "handle2" \
```

```
-cmdName "CLOSE 3"
```

## SEE ALSO

This page intentionally left blank.



# LDAP

This section describes the LDAP Tcl API objects.

## Overview

LDAP protocol commands are organized as shown in the figure below.

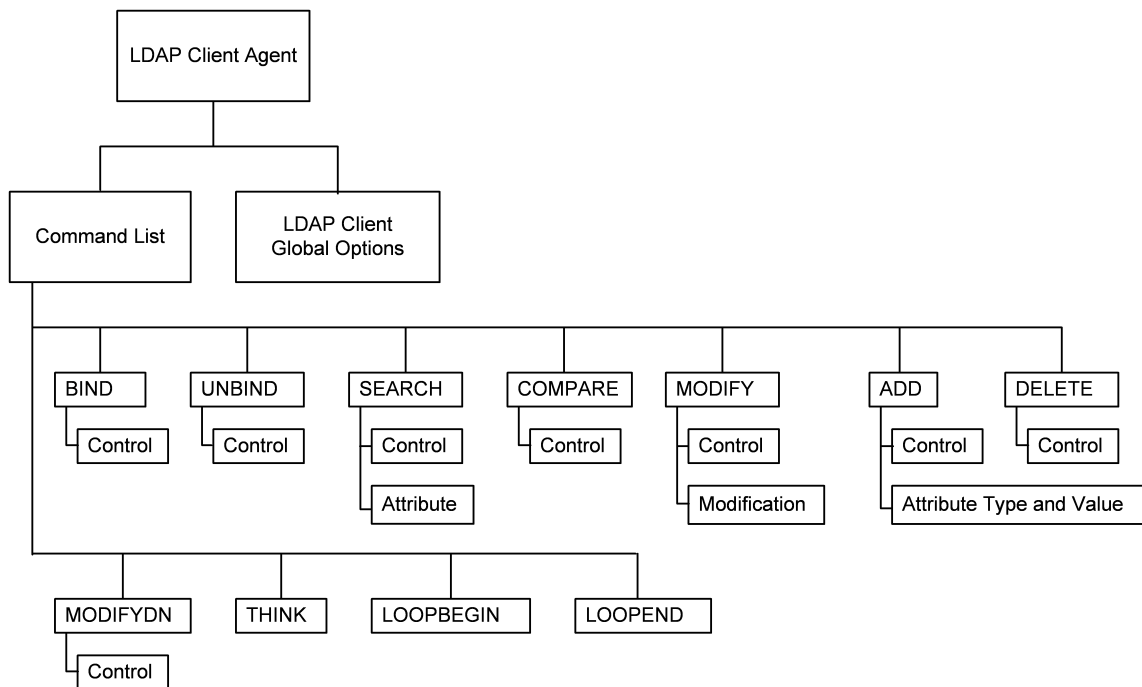

## Objectives

The objectives (userObjective) you can set for LDAP are listed below. Test objectives are set in the ixTimeline object.

- connectionRate

- transactionRate
- simulatedUsers
- concurrentConnections
- throughputMbps
- throughputKbps
- throughputGbps

## LDAP Client Commands

This section lists the LDAP client commands.

### LDAP Client Agent

The LDAP Client Agent command defines a simulated user performing LDAP requests against one or more LDAP servers. Refer to `LDAP Client Agent` for a full description of this command. The most significant options of this command are listed below.

Option	Description
enable	Enables the use of this client agent.
name	The name associated with this object, which must be set at object creation time .
protocol	Protocol used by the client agent.
type	Defines the agent as either a client or server.

### Command List

This command defines the list of commands that the client sends to the server. Refer to `Command List` for a full description of this command. The most significant options of this command are listed below.

Option	Description
id	LDAP command to be executed.

## Global Options

The LDAP client Global Options control network level operation of the client. Refer to `Global Options` for a full description of this command. The most significant options of this command are listed below.

Option	Description
<code>version</code>	Version of the LDAP protocol used for all client sessions.
<code>persistentConnection</code>	If <code>true</code> , the client opens a new TCP connection for each command sent.
<code>maxRequestsPerConn</code>	Maximum number of requests sent on each connection.
<code>maxConcurrentConnPerUser</code>	Maximum number of concurrent connections per user.
<code>followReferral</code>	If <code>true</code> ("On"), and the client receives a response that is a referral to another server, it redirects the request to the referred server.
<code>commandTimeout</code>	Time (in ms) to wait for a response before aborting.
<code>mustBind</code>	If <code>true</code> , the client sends an implicit BIND on every new connection that it establishes.

## Control

Configures a control to be included in a list associated with a command. Refer to `Control` for a full description of this command. The most significant options of this command are listed below.

Option	Description
<code>controlType</code>	LDAP OID of the control associated with the command.
<code>criticality</code>	If <code>true</code> , the control is critical.
<code>controlValue</code>	Value for control.

## Modification

A modification to be included in the `modificationList` of the MODIFY command. Refer to `Modification` for a full description of this command. The most significant options of this command are listed below.

Option	Description
operation	Type of modification to be performed.
type	Attribute to be modified.
valueList	List of values for the operation.

### Attribute

An attribute to be included in the `searchAttributeList` of the SEARCH command. Refer to `Attribute` for a full description of this command. The most significant options of this command are listed below.

Option	Description
attrib	Attribute

### Attribute Type and Values

An attribute and one or more values to be included in the `attribDescValueList` of the ADD command. Refer to `Attribute Type and Values` for a full description of this command. The most significant options of this command are listed below.

Option	Description
type	Attribute.
valueList	List of values for the attribute.

## LDAP Client Agent

LDAP Client Agent - create an LDAP client

### SYNOPSIS

```
set Traffic1_Network1 [::IxLoad new ixNetTraffic]
set Activity_LDAPClient1 [$Traffic1_Network1 activityList.appendItem options...]
$Activity_LDAPClient1 agent.config
```

### DESCRIPTION

An LDAP client agent is added to the `activityList` object. The `activityList` object is added to the `ixNetTraffic` object using the `appendItem` subcommand from the `ixConfigSequenceContainer` command.

Each member of the list, however may be separately addressed and modified using the `ixConfig` subcommands.

### SUBCOMMANDS

The options for this command are configured and read using the standard `config`, `cget`, and `getOption` subcommands defined in the `ixConfig` command.

### OPTIONS

`enable`

Enables the use of this client agent. (Default = true).

`loopValue`

If this option is enabled (1), then the client progresses through the command list repeatedly until the test's sustain time. If the option is disabled (0), then the client will progress through the command list only once, and then go idle. (Default = 0).

`name`

The name associated with this object, which must be set at object creation time.

### STATISTICS

### EXAMPLE

```
set Traffic1_Network1 [::IxLoad new
ixNetTraffic]##### Activity LDAPClient1
of NetTraffic Traffic1@Network1#####set
Activity_LDAPClient1 [$Traffic1_Network1 activityList.appendItem \-protocolAndType
"ldap Client" ]##### Timeline1 for
activities LDAPClient1#####set Timeline1
```

```

[::IxLoad new ixTimeline]$Timeline1 config \-rampUpValue
1 \-rampUpType 0 \-offlineTime
0 \-rampDownTime 20 \-standbyTime
0 \-iterations 1 \-rampUpInterval
1 \-sustainTime 20 \-timelineType
0 \-name "Timeline1"$Activity_LDAPClient1 config
\-enable true \-name
"LDAPClient1" \-enableConstraint false \-userObjectiveValue
100 \-constraintValue 100 \-userObjectiveType
"simulatedUsers" \-timeline $Timeline1$Activity_
LDAPClient1 agent.config \-enable true \-name
"LDAPClient1"$Activity_LDAPClient1 agent.pm.DistinguishedName.DN.clear$Activity_
LDAPClient1 agent.pm.DistinguishedName.DNList.clear$Activity_LDAPClient1 agent.p-
m.globalOptions.config \-initiateCloseFromClient true \-
commandTimeout 10000 \-mustBind
1 \-persistentConnection 1 \-maxRequestsPerConn
10000 \-authType "CLEARTEXT Password" \-version
3 \-maxConcurrentConnPerUser 10 \-followReferral
1 \-password "ixia" \-implicitLoopCheck
true \-name "c=US,o=IXIA"$Activity_LDAPClient1
agent.pm.AddressHistory.clear$Activity_LDAPClient1 agent.pm.cmdList.clear$Activity_
LDAPClient1 agent.pm.cmdList.appendItem \-id
"BIND" \-authType "CLEARTEXT Password" \-password
"ixia" \-name "c=US,o=IXIA" \-serverAddr
"1.2.3.4"$Activity_LDAPClient1 agent.pm.cmdList(0).bindControls.clear$Activity_
LDAPClient1 agent.pm.cmdList(0).bindControls.appendItem \-id
"Control" \-controlValue "2" \-controlType
"1" \-criticality 1

```

**SEE ALSO**[ixNetTraffic](#)

## Command List

Command List—Creates the list of LDAP commands that the client will send to an LDAP server.

### SYNOPSIS

```
set Traffic1_Network1 [::IxLoad new ixNetTraffic]
set Activity_LDAPClient1 [$Traffic1_Network1 activityList.appendItem options...]
$Activity_LDAPClient1 agent.pm.cmdList.appendItem
```

### DESCRIPTION

A command is added to the `Command List` object using the `appendItem` subcommand from the `ixConfigSequenceContainer` command.

Each member of the list, however may be separately addressed and modified using the `ixConfig` subcommands.

### SUBCOMMANDS

The options for this command are configured and read using the standard `config`, `cget`, and `getOption` subcommands defined in the `ixConfig` command.

### OPTIONS

`id`

LDAP command to be executed. One of the following:

Command	Description
BIND	Exchanges authentication information between the client and server.
UNBIND	Terminates an LDAP session. After transmitting an UNBIND command, the client assumes that the session is terminated. There is no response for an UNBIND command. When the server receives an UNBIND, it assumes that the client has terminated the session and all outstanding requests may be discarded.
SEARCH	Requests that the server search its directory for information requested by the client. A SEARCH command can be used to read attributes from a single entry, from entries immediately below a particular entry in the directory tree, or a whole subtree of entries. The SEARCH option includes an Attribute List. You can use this list to add attributes to an LDAPv3 SEARCH command. For a list of the attributes, refer to RFC 2256.

COMPARE	Allows a client to ask the server whether the named entry has an attribute/value pair. The COMPARE command allows the server to keep certain attribute/value pairs secret (that is, not exposed for general search access) while still allowing the client limited use of them. For example, some servers might use this feature for passalthrough it is insecure for the client to pass clear-text passwords in the COMPARE operation itself.
MODIFY	Requests that the server edit an entry on behalf of the client.
ADD	Requests that the server add an entry to the directory.
DELETE	Requests that the server delete a leaf entry from the directory.
MODIFYDN	Allows a client to change a distinguished name (DN) entry or to move a subtree of entries to a new location.
THINK	Causes the client to become inactive. THINK is an internal IxLoad command intended to assist your testing; it is not a comdefined in the LDAP protocol. If you specify identical values for the minimum and maximum intervals, the client will be inactive for a fixed length of time. If you specify different values for the minimum and maximum intervals, IxLoad will select a value within the range and cause the client to be inactive for that length of time.
LOOPBEGIN	An IxLoad command that you can add to the Command List to cause the commands between it and the {Loop End} to be exea specified number of times. For example, in a Command List that contains the following commands: {Loop Begin} BIND SEARCH UNBIND {Loop End} The BIND, SEARCH, and UNBIND commands would be exefor the Number of Iterations specified for the {Loop Begin} command.
LOOPEND	Ends the list of commands that will be executed by the preced{Loop Begin} command.

### Arguments for id = BIND

serverAddr

IP address or host name of the LDAP server that the client will bind to. To spec the port number, add the suffix " :< port number>" to the address or host name . If you do not specify a port number, IxLoad sends the request to the default LDAP port, 389. (Default = "1.2.3.4") .

name

Name of directory object that the client will bind as. (Default = "c = US,o = IXIA") .



authType

Authentication method. The choices for authType are:

authType	Description
"ANONYMOUS"	No authentication. Anonymous authentication is most often used for public read-only directories.
"CLEARTEXT Password"	(Default) Authentication is by user name and password, transmitted unencrypted.
"DIGEST-MD5"	Authentication is by user name and password, transmitted as a SASL MD5 digest. This method provides client authentication with protection against passive eavesdrop attacks, but does not provide protection against active intermediary attacks.

password

Password of the user who wishes to bind. (Default = "ixia").

bindControls

List of optional controls to extend the functionality of the BIND command. See `Control` for a description of how to define a control.

### Arguments for id = UNBIND

serverAddr

IP address or host name of the LDAP server that the client will bind to. To specify the port number, add the suffix " : < port number > " to the address or host name. If you do not specify a port number, IxLoad sends the request to the default LDAP port, 389. (Default = "1.2.3.4").

unbindControls

List of optional controls to extend the functionality of the UNBIND command. See `Control` for a description of how to define a control.

### Arguments for id = SEARCH

serverAddr

IP address or host name of the LDAP server that the client will bind to. To specify the port number, add the suffix " : < port number > " to the address or host name. If you do not specify a port number, IxLoad sends the request to the default LDAP port, 389. (Default = "1.2.3.4").

baseObject

LDAP DN is the root of the subtree to be searched. (Default = "c = US,o = IXIA").

scope

Restricts the search to specific portions of the LDAP directory. The choices are:

Value	Description
0	Base object: Only the DN specified in the Base Object field is searched.
1	Single Level: All fields at the level specified in the Base Object field are searched.
2	(default) Whole subtree: All fields at the level specified in the Base Object field and below it are searched.

`derefAliases`

Indicates how aliases are to be handled. In LDAP, one entry may point to another object in the namespace. This is called an `alias` entry, and it contains the DN of the object that it points to. If you look up an object using the alias, the alias is de-referenced so that what is returned is the object pointed to by the alias's DN. The choices are:

Value	Description
0	(default) Never dereference aliases.
1	Dereference aliases after performing name resolution.
2	Dereference during name resolution.
3	Always dereference aliases.

`sizeLimit`

Maximum number of entries to be returned. Minimum = "0," Maximum = "2,147,483,647." (Default = "10").

`timeLimit`

Maximum time allowed for search, in seconds. Minimum = "0," Maximum = "2,147,483,647." (Default = "5").

`typesOnly`

Determines whether the contents of the search results contain attributes and valor only attributes: The choices are:

Value	Description
0	Both type and value.
1	(default) Only attribute type.

filter

Search filter. RFC 2254 defines the filter representation. `minLength = "5" Default = "(objectClass=*)"`.

searchAttributeList

List of attributes for the search. `searchAttributeList` is of type `ixConfigSequenceContainer`; items are added to the list via the `appendItem` sub-command. See the following example:  
`$attribList searchAttribList.appendItem \`

`-attribcn`

See `Attribute` for a description of how to configure an attribute.

searchControls

List of optional controls to extend the functionality of the `SEARCH` command. See `Control` for a description of how to define a control.

## Arguments for id = COMPARE

serverAddr

IP address or host name of the LDAP server that the client will bind to. To specthe port number, add the suffix `":< port number>"` to the address or host name. If you do not specify a port number, `IxLoad` sends the request to the default LDAP port, 389. (Default = "1.2.3.4").

entry

Name of the entry to be compared. (Default = "c = US,o = IXIA").

attributeDesc

Attribute that is the object of the comparison.

assertionValue

Attribute value that is the object of the comparison.

compareControls

List of optional controls to extend the functionality of the `COMPARE` command. See `Control` for a description of how to define a control.

## Arguments for id = MODIFY

serverAddr

IP address or host name of the LDAP server that the client will bind to. To specthe port number, add the suffix `":< port number>"` to the address or host name. If you do not specify a port number, `IxLoad` sends the request to the default LDAP port, 389. (Default = "1.2.3.4").

directoryObject

Directory Object to be modified. (Default = "c = US,o = IXIA").

modificationList

The list of modifications to be performed. See `Modification` for the description of a modification.

modifyControls

List of optional controls to extend the functionality of the `MODIFY` command. See `Control` for a description of how to define a control.

### Arguments for id = ADD

serverAddr

IP address or host name of the LDAP server that the client will bind to. To specify the port number, add the suffix " : < port number > " to the address or host name. If you do not specify a port number, `IxLoad` sends the request to the default LDAP port, 389. (Default = "1.2.3.4").

entry

Name of the entry to be compared. (Default = "c = US,o = IXIA").

attribDescValueList

List of attributes and values to be added. See `Attribute Type and Values` for the description of adding an attribute type and values.

addControls

List of optional controls to extend the functionality of the `ADD` command. See `Control` for a description of how to define a control.

### Arguments for id = DELETE

serverAddr

IP address or host name of the LDAP server that the client will bind to. To specify the port number, add the suffix " : < port number > " to the address or host name. If you do not specify a port number, `IxLoad` sends the request to the default LDAP port, 389. (Default = "1.2.3.4").

entry

Name of the entry to be compared. (Default = "c = US,o = IXIA").

deleteControls

List of optional controls to extend the functionality of the `DELETE` command. See `Control` for a description of how to define a control.

### Arguments for id = MODIFYDN

serverAddr

IP address or host name of the LDAP server that the client will bind to. To specify the port number, add the suffix " :< port number>" to the address or host name. If you do not specify a port number, IxLoad sends the request to the default LDAP port, 389. (Default = "1.2.3.4").

entry

Name of the entry to be compared. (Default = "c = US,o = IXIA").

newRDN

Relative Distinguished Name (RDN) that will form the leftmost component of the new name of the entry. (Default = "c = US,o = IXIA").

deleteOldrdn

Indicates whether the old RDN attribute values are to be deleted. The choices are:

Value	Description
0	(default) False
1	True

newSuperiorPresent

Indicates whether a new superior DN is to be added. Specify the DN in the `newS` parameter.

Value	Description
0	(default) False
1	True

newSuperior

If `newSuperiorPresent` is true, this is the DN of the entry that becomes the immediate superior of the new entry. If `newSuperiorPresent` is false, this parameter has no effect. (Default = "c = US,o = IXIA").

modifydnControls

List optional of controls to extend the functionality of the MODIFYDN command. See `Control` for a description of how to define a control.

### Arguments for `id = THINK`

minimumInterval

Minimum length of time to pause. Minimum = "1,000," Maximum = "2,147,483,647." (Default = "1,000").

maximumInterval

Maximum length of time to pause. Minimum = "1000," Maximum = "2,147,483,647." (Default = "1,000").

### Arguments for id = LOOPBEGIN

iterations

Number of times to iterate. Value 0 (zero) is treated as infinity. Minimum = "0" Maximum = "2,147,483,647." (Default = "5").

### Arguments for id = LOOPEND

None.

### EXAMPLE

```
$Activity_LDAPClient1 agent.pm.cmdList.appendItem \-id  
"BIND" \-authType "CLEARTEXT Password" \-password  
"ixia" \-name "c=US,o=IXIA" \-serverAddr  
"1.2.3.4"$Activity_LDAPClient1 agent.pm.cmdList(0).bindControls.clear
```

### SEE ALSO

[LDAP Client Agent](#)

## Global Options

Global Options - configure an LDAP client's global options

### SYNOPSIS

```
set Traffic1_Network1 [::IxLoad new ixNetTraffic]
set Activity_LDAPClient1 [$Traffic1_Network1 activityList.appendItem options...]
$Activity_LDAPClient1 agent.pm.globalOptions.config
```

### DESCRIPTION

An LDAP client's global options are set by modifying the options of the `pm.Glooption` of the `LDAP Client Agent` object using its `appendItem`.

### SUBCOMMANDS

None.

### OPTIONS

`version`

Version of the LDAP protocol used for all client sessions. IxLoad supports ver2 and 3. (Default = 3).

`persistentConnection`

If true, the client opens a new TCP connection for each command sent. The choices are:

Value	Description
0	False. If "0" is specified, then the client will not reuse the TCP connection to send a request. It will close the existing connection and open a new connection for sendeach request.
1	(default) True If "1" is specified, then the client will use the existing TCP connection, if one exists. If the TCP connection does not exist, then a new TCP connection will be estab

`maxRequestsPerConn`

Maximum number of requests that can be sent on each connection. On exceeding this limit, the existing connection will be closed and a new one will be opened to send the next request. This parameter is effective only when `persistentConnec` is "1." Minimum = 1, Maximum = 2,147,483,647. (Default = 100).

`maxConcurrentConnPerUser`

Maximum number of concurrent connections per user. Minimum = 1, Maximum = 2,147,483,647. (Default = 10).

`followReferral`

If `true` ("On"), and the client receives a response that is a referral to another server, it redirects the request to the referred server. The choices are:

Value	Description
0	Off
1	(default) On

`commandTimeout`

Time (in ms) to wait for a response before aborting. Minimum = 1, Maximum = 2,147,483,647. (Default = 10,000).

`mustBind`

If `true`, the client sends an implicit BIND on every new connection that it establishes. The choices are:

Value	Description
0	False.
1	(default) True. If set to "1," the client sends an implicit BIND as the first Protocol Data Unit on every new connection that it establishes, provided that a user-configBIND is not the next command to be sent.

### Arguments for `id = mustBind`

`name`

Name of directory object that the client will bind as. (Default = "c = US,o = IXIA").

`authType`

Authentication method. The choices for `authType` are:

Value	Description
"ANONYMOUS"	No authentication. Anonymous authentication is most often used for public read-only directories.
"CLEARTEXT Password"	(Default) Authentication is by user name and password, transmitted unencrypted.
"DIGEST-MD5"	Authentication is by user name and password, transmitted as a SASL MD5 digest. This method provides client authentication with protection against passive eavesdrop attacks, but does not provide protection against active intermediary attacks.

`password`



---

Password of the user who wishes to bind. (Default = "ixia").

**EXAMPLE**

```
$Activity_LDAPClient1 agent.pm.globalOptions.config \-initiateCloseFromClient
true \-commandTimeout 10000 \-mustBind
1 \-persistentConnection 1 \-maxRequestsPerConn
10000 \-authType "CLEARTEXT Password" \-version
3 \-maxConcurrentConnPerUser 10 \-followReferral
1 \-password "ixia" \-implicitLoopCheck
true \-name "c=US,o=IXIA"
```

**SEE ALSO**

[LDAP Client Agent](#)

## Control

Control—An optional control to be included with a command.

### SYNOPSIS

```
set Traffic1_Network1 [::IxLoad new ixNetTraffic]
set Activity_LDAPClient1 [$Traffic1_Network1 activityList.appendItem options...]
$Activity_LDAPClient1 agent.pm.cmdList(0).bindControls.appendItem
```

### DESCRIPTION

Configures a control to be included in a list associated with a command. A conlist is of type `ixConfigSequenceContainer`; items are added to the list via the `appendItem` subcommand.

### SUBCOMMANDS

None.

### OPTIONS

`controlType`

LDAP OID of the control associated with the command.

`criticality`

If `true`, the control is critical. The choices are:

Value	Description
0	False.
1	(default) True.

`controlValue`

Value for control.

### EXAMPLE

```
$Activity_LDAPClient1 agent.pm.cmdList(0).bindControls.appendItem \-id
"Control" \-controlValue          "2" \-controlType
"1" \-criticality                  1
```

### SEE ALSO

[Command List](#)

## Modification

Modification—Configures a modification by the MODIFY command.

### SYNOPSIS

```
set Traffic1_Network1 [::IxLoad new ixNetTraffic]
set Activity_LDAPClient1 [$Traffic1_Network1 activityList.appendItem options...]
$Activity_LDAPClient1 agent.pm.cmdList(1).modificationList.appendItem
```

### DESCRIPTION

A modification to be included in the `modificationList` of the MODIFY command. The `modificationList` is of type `ixConfigSequenceContainer`; items are added to the list via the `appendItem` subcommand.

### SUBCOMMANDS

None.

### OPTIONS

`operation`

Type of modification to be performed. The choices are:

Value	Description
0	Add.
1	Delete.
2	Replace.

`type`

Attribute to be modified. RFC 2256 describes the LDAP attributes.

`valueList`

List of values for the operation. Use semicolons (;) to separate multiple values. See the following example: "value1; value." (Default = {}).

### EXAMPLE

```
$Activity_LDAPClient1 agent.pm.cmdList.appendItem \-id
"MODIFY" \-serverAddr "1.2.3.4" \-directoryObject
"c=US,o=IXIA"$Activity_LDAPClient1 agent.pm.cmdList(1).modificationList.clear$Activ-
ity_LDAPClient1 agent.pm.cmdList(1).modificationList.appendItem \-id
"Modification" \-operation 0 \-type
"1" \-valueList "1;2;3"$Activity_LDAPClient1
```

```
agent.pm.cmdList(1).modifyControls.clear$Activity_LDAPClient1 agent.pm.cmdList(1).-
modifyControls.appendItem \-id "Control" \-
controlValue "2" \-controlType
"1" \-criticality 1
```

**SEE ALSO**

[Command List](#)

## Attribute

Attribute—Configures an attribute for the SEARCH command.

### SYNOPSIS

```
set Traffic1_Network1 [::IxLoad new ixNetTraffic]
set Activity_LDAPClient1 [$Traffic1_Network1 activityList.appendItem options...]
$Activity_LDAPClient1 agent.pm.cmdList(2).searchAttributeList.appendItem
```

### DESCRIPTION

An attribute to be included in the `searchAttributeList` of the SEARCH command. The `searchAttributeList` is of type `ixConfigSequenceContainer`; items are added to the list via the `appendItem` subcommand.

### SUBCOMMANDS

None.

### OPTIONS

`attrib`

Attribute. RFC 2256 describes the LDAP attributes.

### EXAMPLE

```
$Activity_LDAPClient1 agent.pm.cmdList.appendItem \-id
"SEARCH" \-typesOnly 1 \-filter
"(objectClass=*)" \-baseObject "c=US,o=IXIA" \-
derefAliases 0 \-timeLimit
5 \-serverAddr "1.2.3.4" \-sizeLimit
10 \-scope 2$Activity_LDAPClient1 agent.pm.cmdList
(2).searchControls.clear$Activity_LDAPClient1 agent.pm.cmdList(2).searchCon-
trols.appendItem \-id "Control" \-controlValue
"2" \-controlType "1" \-criticality
1$Activity_LDAPClient1 agent.pm.cmdList(2).searchAttributeList.clear$Activity_
LDAPClient1 agent.pm.cmdList(2).searchAttributeList.appendItem \-id
"Attribute" \-attrib "authorityRevocationList"
```

### SEE ALSO

[Command List](#)

## Attribute Type and Values

Attribute Type and Values—Configures an attribute and values for the ADD command.

### SYNOPSIS

```
set Traffic1_Network1 [::IxLoad new ixNetTraffic]
set Activity_LDAPClient1 [$Traffic1_Network1 activityList.appendItem options...]
$Activity_LDAPClient1 agent.pm.cmdList(3).attribDescValueList.appendItem
```

### DESCRIPTION

An attribute and one or more values to be included in the `attribDescValueList` of the ADD command. The `attribDescValueList` is of type `ixConfigSequenceContainer`; items are added to the list via the `appendItem` sub-command.

### SUBCOMMANDS

None.

### OPTIONS

`type`

Type of attribute. RFC 2256 describes the LDAP attributes.

`valueList`

List of values for the attribute. Use semi-colons (;) to separate multiple values. See the following example: "value1; value2". (Default = {}).

### EXAMPLE

```
$Activity_LDAPClient1 agent.pm.cmdList.appendItem \-id
"ADD" \-entry "c=US,o=IXIA" \-serverAddr
"1.2.3.4"$Activity_LDAPClient1 agent.pm.cmdList(3).attribDescValueList.clear$Activ-
ity_LDAPClient1 agent.pm.cmdList(3).attribDescValueList.appendItem \-id
"AttributeTypeAndValues" \-type "1" \-valueList
"1;2;3"
```

### SEE ALSO

Command List

## LDAP Statistics

The table below describes the LDAP statistics.

Statistic	Description
LDAP Total Requests Sent	Total number of requests of all types sent. This statistic is the total of Total number of responses received + Total number of requests aborted.
LDAP Total Requests Sent per sec	Rate at which client sent LDAP requests.
LDAP Total Responses Received	Total number of LDAP responses of all types received.
LDAP Total Responses Received per sec	Rate at which client received LDAP responses.
LDAP Total Requests Aborted	Total number of requests of all types for which no response was received within the time limit.
LDAP BIND Requests Sent	Total number of BIND requests sent. This statistic is the total of Total number of BIND responses received + Total number of BIND requests aborted.
LDAP BIND Responses Received	Total number of BIND responses of all types received.
LDAP BIND Requests Aborted	Total number of BIND requests for which no response was received within the time limit.
LDAP BIND Success Responses	Total number of successful responses to BIND commands received by the client.
LDAP BIND Failure Responses	Total number of failure responses to BIND commands received by the client.
LDAP BIND Responses With Referrals	Total number of responses to BIND commands that contained referrals.

LDAP UNBIND Requests	Total number of UNBIND requests sent by the client.
LDAP SEARCH Requests Sent	Total number of SEARCH requests sent by the client.
LDAP SearchResultDone Responses Received	Total number of responses received indicating that the search was completed. This statistic is a total of = Total number of SearchResultDone with success + Total number of SearchResultDone with failure + Total number of SearchResultDone with sizelimit exceeded error + Total number of SearchResultDone with timelimit exceeded error + Total number of SearchResultDone with referral.
LDAP Search Requests Aborted	Total number of Search requests for which no response was received within the time limit specified on the Global tab.
LDAP SearchResultDone Responses With Success	Total number of successful searches completed.
LDAP SearchResultDone Responses With Failure	Total number of failed searches completed.
LDAP SearchResultDone Responses With Sizelimit Exceeded Error	Total number of searches completed whose results exceeded the size limit.
LDAP SearchResultDone Responses With Timelimit Exceeded Error	Total number of searches completed that exceeded the time limit specified on the SEARCH form.
LDAP SearchResultDone Responses With Referrals	Total number of searches completed that contained referrals.
LDAP SearchResult Entries Received	Total number of entries received in response to searches. One search may return zero, one, or more than one entries.



LDAP SearchResult Entries Received per sec	Total number of referrals received in response to searches. One search may return zero, one, or more than one referrals.
LDAP ADD Requests Sent	Total number of Add requests sent by the client. This statistic is a total of Total number of Add responses received + Total number of Add requests aborted.
LDAP ADD Responses Received	Total number of Add responses received by the client.
LDAP ADD Requests Aborted	Total number of Add requests for which no response was received within the time limit.
LDAP ADD Success Responses	Total number of responses received indicating that an Add request succeeded.
LDAP ADD Failure Responses	Total number of responses received indicating that an Add request failed.
LDAP ADD Responses With Referrals	Total number of responses to Add requests that contained a referral.
LDAP MODIFY Requests Sent	Total number of Modify requests sent by the client. This statistic is the total of: Total number of Modify responses received + Total number of Modify requests aborted.
LDAP MODIFY Responses Received	Total number of responses to Modify requests received by the client.
LDAP MODIFY Requests Aborted	Total number of Modify requests for which no response was received within the time limit.
LDAP MODIFY Success Responses	Total number of responses received indicating that a Modify request succeeded.
LDAP MODIFY Failure Responses	Total number of responses received indicating that a Modify request failed.
LDAP MODIFY Responses With Referrals	Total number of responses to Modify requests that contained a referral.

LDAP DELETE Requests Sent	Total number of Delete requests sent by the client. This statistic is the total of: Total number of Delete responses received + Total number of Delete requests aborted.
LDAP DELETE Responses Received	Total number of Delete responses received by the client.
LDAP DELETE Requests Aborted	Total number of Delete requests for which no response was received within the time limit.
LDAP DELETE Success Responses	Total number of responses received indicating that a Delete request succeeded.
LDAP DELETE Failure Responses	Total number of responses received indicating that a Delete request failed.
LDAP DELETE Responses With Referrals	Total number of responses to Delete requests that contained a referral.
LDAP MODIFYDN Requests Sent	Total number of ModifyDN requests sent by the client. This statistic is the total of: Total number of ModifyDN responses received + Total number of ModifyDN requests aborted.
LDAP MODIFYDN Responses Received	Total number of ModifyDN responses received by the client.
LDAP MODIFYDN Requests Aborted	Total number of ModifyDN requests for which no response was received within the time limit.
LDAP MODIFYDN Success Responses	Total number of responses received indicating that a ModifyDN request succeeded.
LDAP MODIFYDN Failure Responses	Total number of responses received indicating that a ModifyDN request failed.
LDAP MODIFYDN Responses With Referrals	Total number of responses to ModifyDN requests that contained a referral.
LDAP COMPARE Requests Sent	Total number of Compare requests sent by the client. This statistic is the total of: Total number of Compare responses received + Total number of Compare requests aborted.

LDAP COMPARE Responses Received	Total number of Compare responses received by the client.
LDAP COMPARE Requests Aborted	Total number of Compare requests for which no response was received within the time limit.
LDAP COMPARE Responses With Result TRUE	Total number of responses indicating that the string in the Compare request existed in the directory.
LDAP COMPARE Responses With Result FALSE	Total number of responses indicating that the string in the Compare request did not exist in the directory.
LDAP COMPARE Failure Responses	Total number of responses received indicating that a Compare request failed.
LDAP COMPARE Responses With Referrals	Total number of responses to Compare requests that contained a referral.
LDAP Notice Of Disconnection Received	Total number of Notices of Disconnection received by the client.
LDAP BIND Response Time	Average time elapsed between sending a Bind request and receiving a complete response. Note for Tcl API users: This is a weighted statistic. If you are using this statistic in a Tcl script, use the <i>kWeightedAverage</i> aggregation type.
LDAP SEARCH Response Time	Average time elapsed between sending a Search request and receiving a SearchResultDone response. Note for Tcl API users: This is a weighted statistic. If you are using this statistic in a Tcl script, use the <i>kWeightedAverage</i> aggregation type.
LDAP ADD Response Time	Average time elapsed between sending an Add request and receiving a complete response. Note for Tcl API users: This is a weighted statistic. If you are using this statistic in a Tcl script, use the <i>kWeightedAverage</i> aggregation type.
LDAP MODIFY Response Time	Average time elapsed between sending a Modify request and receiving a complete response. Note for Tcl API users: This is a weighted statistic. If you are using this statistic in a Tcl script, use the <i>kWeightedAverage</i> aggregation type.

LDAP DELETE Response Time	Average time elapsed between sending a Delete request and receiving a complete response. Note for Tcl API users: This is a weighted statistic. If you are using this statistic in a Tcl script, use the <i>kWeightedAverage</i> aggregation type.
LDAP MODIFYDN Response Time	Average time elapsed between sending a ModifyDN request and receiving a complete response. Note for Tcl API users: This is a weighted statistic. If you are using this statistic in a Tcl script, use the <i>kWeightedAverage</i> aggregation type.
LDAP COMPARE Response Time	Average time elapsed between sending a Compare request and receiving a complete response. Note for Tcl API users: This is a weighted statistic. If you are using this statistic in a Tcl script, use the <i>kWeightedAverage</i> aggregation type.
LDAP Avg Time To Receive First Byte Of Response	Average time required to receive the first byte of a SEARCH response. The time is averaged because a SEARCH command may return multiple responses. Note for Tcl API users: This is a weighted statistic. If you are using this statistic in a Tcl script, use the <i>kWeightedAverage</i> aggregation type.
LDAP Avg Time To Receive Last Byte Of Response	Average time required to receive the last byte of a SEARCH response. The time is averaged because a SEARCH command may return multiple responses. Note for Tcl API users: This is a weighted statistic. If you are using this statistic in a Tcl script, use the <i>kWeightedAverage</i> aggregation type.
LDAP Simulated Users	Number of users simulated during the test.
LDAP Connections Established	Total number of LDAP connections established. An LDAP connection occurs when an LDAP client successfully connects to an LDAP server.
LDAP Connections Established per sec	Rate at which the client established LDAP connections
LDAP Active Connections	Number of simultaneous LDAP connections established.
LDAP Total Transactions	Total number of LDAP transactions completed by the client. An LDAP transaction occurs when an LDAP client sends a request to an LDAP server and receives a response, either of success or failure.
LDAP Transactions per sec	Rate at which the client completed LDAP transactions.

---

LDAP Concurrent Sessions	Number of simultaneous LDAP sessions in progress. An LDAP session occurs when an LDAP client successfully connects to an LDAP server.
LDAP Total Bytes Transmitted	Total number of bytes sent by the client in LDAP requests. This statistic counts only the bytes in the payload portion of the LDAP packets.
LDAP Total Bytes Received	Total number of bytes received by the client in LDAP responses.
LDAP Total Bytes Transmitted per sec	Rate at which the client transmitted bytes in LDAP requests.
LDAP Total Bytes Received per sec	Rate at which the client received bytes in LDAP responses.
LDAP Total Bytes Sent and Received	Combined total of bytes sent and received in LDAP requests and responses.
LDAP Throughput	Total throughput over the LDAP connections, in bytes per second.

This page intentionally left blank.

## Peer-to-Peer Application

This section describes the Peer-to-Peer Application Tcl API objects.

### Objectives

The objectives (userObjective) you can set for Peer-to-Peer are listed below. Test objectives are set in the ixTimeline object.

- simulatedUsers
- peerCount (displays as "Initiator Peer Count" in the GUI)
- connectionRate
- concurrentConnections
- throughputMbps
- throughputKbps
- throughputGbps
- transactionRate

## Peer-to-Peer Application Agent

Peer-to-Peer Application Agent - create a peer-to-peer agent

### SYNOPSIS

```
set Traffic1_Network1 [::IxLoad new ixNetTraffic]
set Activity_P2PApplicationPeer1 [$Traffic1_Network1 activityList.appendItem
options...]
$Activity_P2PApplicationPeer1 agent.config
```

### DESCRIPTION

An `Activity_P2PApplicationPeer1` agent is added to the `activityList` object. The `activityList` object is added to the `ixNetTraffic` object using the `appendItem` subfrom the `ixConfigSequenceContainer` command.

### SUBCOMMANDS

The options for this command are configured and read using the standard `config`, `cget`, and `getOption` subcommands defined in the `ixConfig` command.

### OPTIONS

`enable`

Enables the use of this client agent. (Default = true).

`name`

The name associated with this object, which must be set at object creation time.

### STATISTICS

#### EXAMPLE

```
set Traffic1_Network1 [::IxLoad new
ixNetTraffic]##### Activity Activity_
P2PApplicationPeer1 of NetTraffic
Traffic1@Network1#####set Activity_P2PApp-
plicationPeer1 [$Traffic1_Network1 activityList.appendItem \-protocolAndType
"p2papp Peer" ]$Activity_P2PApplicationPeer1 agent.config \-enable
true \

-name "P2PApplicationPeer1"
```

### SEE ALSO

`ixNetTraffic`





## FlowDefinition

FlowDefinition—Defines a list of P2P flows.

### SYNOPSIS

```
set ServerTraffic1_ServerNetwork1 [::IxLoad new ixNetTraffic]
set Activity_P2PApplicationPeer1 [$Traffic1_Network1 activityList.appendItem
options...]
$Activity_P2PApplicationPeer1 agent.pm.protocolFlows.appendItem
```

### DESCRIPTION

An option is added to the list of protocol flows using the `appendItem` subcommand from the `ixConfigSequenceContainer` command.

### SUBCOMMANDS

None

### OPTIONS

`remotePeer`

P2P activity that is the destination of traffic sent by this peer, and the origin of traffic received by it.

`responderPort`

Port number that responding peer listens on (Default=10000).

### EXAMPLE

```
Activity_P2PApplicationPeer1 agent.pm.protocolFlows.clear$Activity_P2PApplicationPeer1 agent.pm.protocolFlows.appendItem \
-id "InbuiltFlow" \
-remotePeer "Traffic2_P2PApplicationPeer2" \
-subType "Bittorrent" \
-flowType "Simple Bidirectional" \
-responderPort 10000
```

### SEE ALSO

[InbuiltFlow](#)

## InbuiltFlow

InbuiltFlow —Defines the parameters of an inbuilt P2P flow.

### SYNOPSIS

```
$Activity_P2PApplicationPeer1 agent.pm.protocolFlows.appendItem
```

### DESCRIPTION

An option is added to the `ProtocolFlows` list of using the `appendItem` subcommand from the `ixConfigSequenceContainer` command.

### SUBCOMMANDS

None

### OPTIONS

`subType`

The peer-to-peer protocol type:

- Bittorrent
- e-donkey

`flowType`

A peer-to-peer flow type defined as one of the following:

```
Simple Download (Bittorent)
Simple Upload (Bittorent)
Simple Bidirectional (Bittorent)
Bidirectional to Download (Bittorent)
Bidirectional to Long Download (Bittorent)
Bidirectional to Upload (Bittorent)
Bidirectional to Long Upload (Bittorent)
Download to Upload (Bittorent)
Download to Long Upload (Bittorent)
Download to Bidirectional (Bittorent)
Download to Long Bidirectional (Bittorent)
SimpleControlFlow-1 (e-donkey)
SimpleControlFlow-2 (e-donkey)
Simple Download (e-donkey)
Download to Upload (e-donkey)
Download to Long Upload (e-donkey)
Download to Bidirectional (e-donkey)
Download to Long Bidirectional (e-donkey)
```

```
Simple Upload (e-donkey)
Simple Upload to Download (e-donkey)
Upload to Bidirectional (e-donkey)
Simple Bidirectional (e-donkey)
Unknown Direction-1, Unknown Direction-2, Unknown Direction-3 (e-donkey)
Queued (e-donkey)
Queued Callback (e-donkey)
Queued Callback to Download (e-donkey)
Queued Callback to Bidirectional (e-donkey)
```

dataSegments

A list of DataSegment objects.

### EXAMPLE

```
Activity_AppReplayPeer1 agent.pm.protocolFlows.clear$Activity_P2PApplicationPeer1
agent.pm.protocolFlows.appendItem \
-id "InbuiltFlow" \
-remotePeer "Traffic2_P2PApplicationPeer2" \
-subType "Bittorrent" \
-flowType "Simple Bidirectional" \
-responderPort 10000
```

### SEE ALSO

[FlowDefinition](#)

## Peer-to-peer Global Statistics

The following table describes the Peer-to-peer statistics.

Statistic	Description
Test Objective Statistics	
P2P Application Initiator Peer Count	Number of P2P initiators created.
P2P Application Responder Peer Count	Number of P2P responders created.
P2P Application Concurrent Sessions	Number of concurrent sessions established between peers.
P2P Application Connection Rate	Rate (in connections per second) at which P2P peers connected to each other.
P2P Application Transaction Rate	<p>Rate (in transactions per second) at which P2P peers completed transactions.</p> <p>For P2P peers, transactions consist of exchanges of request-response control byte codes.</p> <p>A transaction begins when an initiator sends the first control byte code, and ends when the responder sends a control byte code in response.</p> <p>If a response requires multiple control byte codes, the transaction ends when the responder sends the final byte code.</p>
P2P Application Initiator Total Bytes Sent/sec	Rate at which the initiators sent data.
P2P Application Initiator Total Bytes Received/sec	Rate at which the initiators received data.
P2P Application Initiator Total Throughput	Combined rate at which the initiators sent and received data.
P2P Application Responder Total Bytes Sent/sec	Rate at which the responders sent data.

P2P Application Responder Total Bytes Received/sec	Rate at which the responders received data.
P2P Application Responder Total Throughput	Combined rate at which the responders sent and received data.
Total Connection Statistics	
P2P Application Connection Requests Sent	Number of connection requests sent by the initiators to the responders.
P2P Application Connection Requests Successful	Number of connection attempts that succeeded.
P2P Application Connection Requests Failed	Number of connection attempts that failed.
P2P Application Active Connections	Number of connections currently active.
P2P Application Connection Requests Received	Number of connection requests received by the responders.
P2P Application Connections Accepted	Number of connections accepted by the responders. This statistic measures the number of successful connections from the point of view of the responder.
P2P Application Connections Failed	Number of connections that were established but then closed because they would have exceeded the maximum number of connections that the responder could support. The maximum number of connections that the responder can accept is calculated based on the test configuration and depends on the resources available on the load module, such as memory.
Total Transaction Statistics	
P2P Application Total Transactions Initiated	Total number of P2P transactions initiated.

P2P Application Total Transactions Successful	Total number of P2P transactions that succeeded.
Total Flow Statistics	
P2P Application Total Flow Initiated	Total number of control and data flows initiated.
P2P Application Total Active Flow	Total number of control and data flows active.
P2P Application Total Flow Succeeded	Total number of flows of control and data that completed successfully.
P2P Application Total Flow Failed	Total number of control and data flows that failed for any reason.
P2P Application Total Flow Failed Error	Total number of control and data flows that failed due to a network error.
P2P Application Total Flow Failed Timeout	Total number of control and data flows that failed due to a timeout.
P2P Application Total Flow Failed Mismatch	Total number of control and data flows that failed because the data sent did not match the data that was expected.
P2P Application Total Flow Aborted	Number of P2P sessions that ended abnormally.
Initiator Total Bytes Statistics	
P2P Application Initiator Total Bytes Sent	Total number of bytes sent by the initiators.
P2P Application Initiator Total Bytes Received	Total number of bytes received by the initiators.
P2P Application Initiator Total Bytes Sent and Received	Combined total of bytes sent and received by the initiators.
Responder Total Bytes Statistics	

P2P Application Responder Total Bytes Sent	Total number of bytes sent by the responders.
P2P Application Responder Total Bytes Received	Total number of bytes received by the responders.
P2P Application Responder Total Bytes Sent and Received	Combined total number of bytes sent and received by the responders.
Control Tx/Rx Statistics	
P2P Application Control Segment Transmission Initiated	Number of control flows established. A control flow is the series of messages exchanged between peers before beginning the data flow. Control flows can also sometimes occur between data flows.
P2P Application Control Segment Transmission Succeeded	Number of control flows that succeeded (Initiator side).
P2P Application Control Segment Transmission Failed	Total number of control flows that failed for any reason (Initiator side).
P2P Application Control Segment Transmission Failed (Error)	Number of control flows that failed due to a network error (Initiator side).
P2P Application Control Segment Transmission Failed (Timeout)	Number of control flows that failed due to a timeout (Initiator side).
P2P Application Control Segment Reception Initiated	Number of control flows that the responders are receiving.
P2P Application Control Segment Reception Succeeded	Number of control flows that completed successfully (Responder side).



P2P Application Control Segment Reception Failed	Number of control flows that failed to complete for any reason (Responder side).
P2P Application Control Segment Reception Failed (Error)	Number of control flows that failed to complete due to a network error (Responder side).
P2P Application Control Segment Reception Failed (Timeout)	Number of control flows that failed to complete due to a timeout (Responder side).
P2P Application Control Segment Reception Failed (Mismatch)	Number of control flows that failed to complete because the data sent did not match the data that was expected (Responder side).
Data Tx/Rx Statistics	
P2P Application Data Segment Transmission Initiated	<p>Number of data flows currently active.</p> <p>A data flow is the stream of related payload data sent from an initiator or a responder.</p> <p>For example, if, in the Data Definition table, a Simple Upload flow is selected and the Upload Data Size is 4096 bytes, then the transmission of 4096 bytes of data from initiator to responder constitutes one successful data flow.</p>
P2P Application Data Segment Transmission Succeeded	Number of data flows that completed successfully (Initiator side).
P2P Application Data Segment Transmission Failed	Number of data flows that failed (Initiator side).
P2P Application Data Segment Transmission Failed (Error)	Number of data flows that failed due to a network error (Initiator side).
P2P Application Total Data Segment Transmission Failed (Timeout)	Number data flows that failed due to a timeout (Initiator side).

P2P Application Data Segment Reception Initiated	Number of data flows that the responders are receiving.
P2P Application Data Segment Reception Succeeded	Number of data flows that completed successfully (Responder side).
P2P Application Data Segment Reception Failed	Number of data flows that failed for any reason (Responder side).
P2P Application Data Flow Reception Failed (Error)	Number of data flows that failed due to a network error (Responder side).
P2P Application Data Segment Reception Failed (Timeout)	Number of data flows that failed due to a timeout (Responder side).

# POP3

This section describes the POP3 Tcl API objects.

## Overview

POP3 protocol commands are organized as:

- POP3 Client Agent
- Pop3Command
- POP3 Server Agent
- MailBoxItem

An additional discussion item is included:

- *Using Auto-Generated Strings*—which pertains to several commands.

## Objectives

The objectives (userObjective) you can set for POP3 are listed below. Test objecare set in the ixTimeline object.

- connectionRate
- transactionRate
- simulatedUsers
- concurrentConnections
- throughputMbps
- throughputKbps
- throughputGbps

## POP3 Client Agent

The POP3 Client Agent defines a simulated user performing POP3 requests against one or more POP3 servers. Refer to `POP3 Client Agent` for a full descriptof this command. The important options of this command are listed below.

Option	Usage
enable	Enables the use of the POP3 client agent.
name	The name associated with the client agent.
commandList	A list of commands to be sent to the server. Each list member is of type <code>Pop3Command</code> .
commandTimeout	Client timeout value.

### Pop3Command

Each client command is a single step in the interaction. Refer to `Pop3Command` for a full description of this command. The important options of this command are listed below.

Subcommand	Usage
checkConfig	Checks the configuration of the action.

Option	Usage
command arguments	The POP3 command, with optional arguments, to be executed.

### POP3 Server Agent

The POP3 Server Agent defines the operation of the POP3 server. Refer to `POP3 Server Agent` for a full description of this command. The important options of this command are listed below.

Option	Usage
enable	Enables the use of this server agent.
name	The name associated with the server agent.
concurrentSessionLimit	The maximum number of concurrent sessions that the server will allow.

---

Server_Listening_Port	Port that the POP3 server listens on for new connections.
mailbox	The contents of a user's mailbox, to be returned to the POP3 user upon request. A list, each of whose elements are of type <code>MailBoxItem</code> .

## MailBoxItem

Each `MailBoxItem` is a mail item that a POP3 user will retrieve from a server. Refer to `MailBoxItem` for a full description of this command. The important options of this command are listed below.

Option	Usage
count	The number of messages in <code>mailMessage</code> to be returned.
mailMessage	A reference to a mail message, of type <code>MailMessage</code> . <code>MailMessage</code> is a command shared by the SMTP and POP3 protocols.

## POP3 Client Agent

POP3 Client Agent - configure a POP3 client

### SYNOPSIS

```
set Traffic1_Network1 [::IxLoad new ixNetTraffic]
set Activity_POP3Client1 [$Traffic1_Network1 activityList.appendItem
$Activity_POP3Client1 agent.config options...
```

### DESCRIPTION

A POP3 client agent is added to the `activityList` object. The `activityList` object is added to the `ixNetTraffic` object using the `appendItem` subcommand from the `ixConfigSequenceContainer` command.

Each member of the list, however may be separately addressed and modified using the `ixConfig` subcommands.

### SUBCOMMANDS

The options for this command are configured and read using the standard `config`, `cget`, and `getOption` subcommands defined in the `ixConfig` command.

### OPTIONS

`commandList`

This is a list of type `ixConfigSequenceContainer` used to hold objects of type `Pop3Command`. The elements in this list describe the operations to be performed by the server. (Default = {}).

`commandTimeout`

Amount of time allowed to an POP3 command to complete. If the command does not complete within the allowed time, IxLoad closes the POP3 client's connecto the POP3 server. (Default = 120).

`enable`

Enables the use of this client agent. (Default = true).

`ipPreference`

This option indicates the order by which the POP3 client will use the subnets, if there is a mixture of IPv4 and IPv6 subnets in the network. The values are: `IpPreferenceV4`, `IpPreferenceV6`, `IpPreferenceV4Any`, `IpPreferenceV6Any`.

`loopValue`

If this option is enabled (1) then the client progresses through the command list repeatedly until the test's sustain time. If the option is disabled (0), then the client will progress through the command list only once, and then go idle. (Default = 0).

name

The name associated with this object, which must be set at object creation time.

enableVlanPriority

VLAN Priority can be set on a per-activity basis or on a per-network (NetTraffic) basis. This parameter sets the VLAN priority for the activity. An activity's VLAN Priority bit setting takes precedence over a network's Priority bit setting. If `true`, IxLoad sets the VLAN Priority bit in traffic from this activity. Configure the VLAN priority value in `vlanPriority`. (Default = `false`).

vlanPriority

When `enableVlanPriority` is `true`, this option accepts the `vlan` priority value.

## STATISTICS

### EXAMPLE

```
set Traffic1_Network1 [::IxLoad new
ixNetTraffic]##### Activity POP3Client1
of NetTraffic Traffic1@Network1#####set
Activity_POP3Client1 [$Traffic1_Network1 activityList.appendItem \-protocolAndType
"POP3 Client" ]##### Timelinel for
activities POP3Client1#####set Timelinel
[::IxLoad new ixTimeline]$Timelinel config \-rampUpValue
1 \-rampUpType 0 \-offlineTime
0 \-rampDownTime 20 \-standbyTime
0 \-iterations 1 \-rampUpInterval
1 \-sustainTime 20 \-timelineType
0 \-name "Timelinel"$Activity_POP3Client1 config
\-enable true \-name
"POP3Client1" \-enableConstraint false \-userObjectiveValue
100 \-constraintValue 100 \-userObjectiveType
"simulatedUsers" \-timeline $Timelinel$Activity_
POP3Client1 agent.config \-commandTimeout 120 \-enable
true \-ipPreference 0 \-name
"POP3Client1" \-vlanPriority 0 \-enableVlanPriority
false \-loopValue true$Activity_POP3Client1 agent.-
commandList.clearset my_Pop3Command [::IxLoad new Pop3Command]$my_Pop3Command config
\-command "USER" \-arguments
"username"$Activity_POP3Client1 agent.commandList.appendItem -object $my_
Pop3Commandset my_Pop3Command1 [::IxLoad new Pop3Command]$my_Pop3Command1 config \-
command "PASSWORD" \-arguments
"password"$Activity_POP3Client1 agent.commandList.appendItem -object $my_Pop3Com-
mand1set my_Pop3Command2 [::IxLoad new Pop3Command]$my_Pop3Command2 config \-command
"{Get}" \-arguments "None"$Activity_POP3Client1 agent.-
commandList.appendItem -object $my_Pop3Command2
```

**SEE ALSO**

[ixNetTraffic](#)

[Pop3Command](#)



## Pop3Command

Pop3Command—Specifies the contents of an POP3 client command.

### SYNOPSIS

```
set Traffic1_Network1 [::IxLoad new ixNetTraffic]
set Activity_POP3Client1 [$Traffic1_Network1 activityList.appendItem
set my_Pop3Command [::IxLoad new Pop3Command]
$Activity_POP3Client1 agent.commandList.appendItem -object $my_Pop3Command
```

### DESCRIPTION

An `POP3Command` object is added to the `commandList` option of the `POP3 Client Agent` object using the `appendItem` subcommand from the `ixConfigSequenceContainer` command.

Each member of the list, however may be separately addressed and modified using the `ixConfig` subcommands.

### SUBCOMMANDS

The options for this command are configured and read using the standard `config`, `cget`, and `getOption` subcommands defined in the `ixConfig` command.

### OPTIONS

arguments

Optional arguments related to the POP3 command to be executed. One of:

Command	Usage
"USER"	The user name that this client will use to login to the POP3 server. You can include variables in the user name; see <a href="#">Using Auto-Generated Strings</a> .
"PASSWORD"	The password used to login to the POP3 server. You can use <code>variin</code> in this field to generate multiple passwords. See <a href="#">Using Auto-Generated Strings</a> .
"APOP"	The shared secret to be used to connect to a POP3 server that uses the APOP command to authenticate clients.
"OPEN"	The name and port of the server, of the form: "<IP address>:<TCP Port Number>"
"STAT"	N/A
"DELE"	The ID number of the message to be deleted.
"NOOP"	N/A

"RSET"	N/A
"LIST"	A single message ID or an empty string ("") for all IDs.
"UIDL"	A single message ID or an empty string ("") for all IDs.
"RETR"	A message ID.
"TOP"	This can be either: "<Message ID>" or "<Message ID>:<Number of Lines>."
"QUIT"	N/A
"{Get}"	(Default) The name and port of the server, of the form: "<symbolic/IP address>:<TCP Port Number>"
"{Think}"	The number of seconds to wait. Default is 1 second.

command

The POP3 command to be executed. One of:

Command	Usage
"USER"	The user name that this client will use to login to the POP3 server is specified in the <code>argument</code> option. You can include variables in the user name; see <i>Using Auto-Generated Strings</i> .
"PASSWORD"	The password used to login to the POP3 server is specified in the <code>argument</code> option. You can use variables in this field to generate mulpasswords. See <i>Using Auto-Generated Strings</i> .
"APOP"	The shared secret to be used to connect to a POP3 server that uses the APOP command to authenticate clients. APOP (Authenticated POP) is a method of authenticating a POP3 session that does not require a cleartext password to be sent. The shared secret is a string known only to the POP3 client and server, and is part of the authentication process. You can use variables in this field to generate multiple shared secrets. See <i>Using Auto-Generated Strings</i> .
"OPEN"	Opens the TCP connection.
"STAT"	Similar to the LIST command in that it causes the server to return the number of messages in the mail drop along with the total space occupied (in octets) by those messages. Unlike the RETR or LIST commands, STAT cannot be used to display messages.

"DELE"	Identifies a message to be deleted by passing its ID numbers in the <code>argument</code> option. The LIST command returns message IDs.
"NOOP"	A null or NO OPERATION. A POP3 server's response to a NOOP is to do nothing.
"RSET"	Resets the state of messages marked for deletion.
"LIST"	Lists the number of stored messages and their combined size, in octets. You can also use the result of this command to obtain the size of a single message; include the message's number as the <code>conof</code> of the <code>argument</code> option.
"UIDL"	Returns the Unique ID Listing for a message. If the contents of <code>argument</code> is empty, a numerical listing of all messages and their associated UIDLs is returned. If the <code>arguments</code> option contains a specific UIDL, then the contents of the message is returned.
"RETR"	Returns the full text of the specified message, and marks that message read. Passes the message number returned by the LIST command in the <code>argument</code> option to identify the message to be retrieved.
"TOP"	Displays a message's header and the specified number of lines, counted from the top. This command takes two arguments: the <code>mesnumber</code> and the number of lines to display. The server returns the message headers followed by a blank line and then the specified number of lines from the message.
"QUIT"	Ends the POP3 session and deletes any messages marked for deletion.
"{Get}"	(Default) An <code>IxLoad</code> command that retrieves all waiting messages for the user, then logs out. <code>{Get}</code> is a single command that performs the same function as multiple POP3 commands. However, <code>{Get}</code> is not a standard POP3 command. It is included in <code>IxLoad</code> for your convenience to make configuring POP3 clients easier.
"{Think}"	An amount of time to wait before issuing the next command.
"{LoopBegin}"	An <code>IxLoad</code> command that you can add to the Command List to cause the commands between it and the <code>{Loop End}</code> to be executed a specified number of times.
"{LoopEnd}"	Ends the list of commands that will be executed by the preceding <code>{Loop Begin}</code> command.

**EXAMPLE**

```
set my_Pop3Command [::IxLoad new Pop3Command]$my_Pop3Command config \-command
"USER" \-arguments "username"$Activity_POP3Client1
agent.commandList.appendItem -object $my_Pop3Commandset my_Pop3Command1 [::IxLoad
new Pop3Command]$my_Pop3Command1 config \-command
```

```
"PASSWORD" \-arguments                                "password"$Activity_POP3Client1
agent.commandList.appendItem -object $my_Pop3Command1set my_Pop3Command2 [::IxLoad
new Pop3Command]$my_Pop3Command2 config \-command      "
{Get}" \-arguments                                    "None"$Activity_POP3Client1 agent.-
commandList.appendItem -object $my_Pop3Command2
```

**SEE ALSO**

[POP3 Client Agent](#)

[Using Auto-Generated Strings](#)

---

## POP3 Server Agent

POP3 Server Agent - create a POP3 server

### SYNOPSIS

```
set Traffic2_Network2 [::IxLoad new ixNetTraffic]
set Activity_POP3Server1 [$Traffic2_Network2 activityList.appendItem
$Activity_POP3Server1 agent.config options...
```

### DESCRIPTION

A POP3 server agent is added to the `activityList` object. The `activityList` object is added to the `ixNetTraffic` object using the `appendItem` subcommand from the `ixConfigSequenceContainer` command.

Each member of the list, however may be separately addressed and modified using the `ixConfig` subcommands.

### SUBCOMMANDS

The options for this command are configured and read using the standard `config`, `cget`, and `getOptions` subcommands defined in the `ixConfig` command.

### OPTIONS

`concurrentSessionLimit`

The maximum number of concurrent sessions to be supported by the agent. (Default = 1,000).

`enable`

Enables the use of this action. (Default = true).

`mailBox`

This is a list of type `MailBoxItem`. The elements in this list are the messages that a POP3 user will receive when he queries the mailbox. (Default = {}).

`mailMessageList`

This is a list of type `MailMessage`. The elements in this list contain the messages to be returned to a POP3 client. (Default = {}).

`name`

The name associated with this object, which must be set at object creation time.

`serverlisteningport`

Port that the POP3 server listens on. To specify multiple ports, separate the port numbers with commas (,). You can specify up to 50 listening ports. (Default = 110).

enableVlanPriority

VLAN Priority can be set on a per-activity basis or on a per-network (NetTraffic) basis. This parameter sets the VLAN priority for the activity. An activity's VLAN Priority bit setting takes precedence over a network's Priority bit setting. If `true`, IxLoad sets the VLAN Priority bit in traffic from this activity. Configure the VLAN priority value in `vlanPriority`. (Default = false).

vlanPriority

When `enableVlanPriority` is `true`, this option accepts the `vlan` priority value.

## STATISTICS

### EXAMPLE

```
set Traffic2_Network2 [::IxLoad new
ixNetTraffic]##### Activity POP3Server1
of NetTraffic Traffic2@Network2#####set
Activity_POP3Server1 [$Traffic2_Network2 activityList.appendItem \-protocolAndType
"POP3 Server" ]set _Match_Longest_ [::IxLoad new ixMatchLongestTimeline]$Activity_
POP3Server1 config \-enable true \-name
"POP3Server1" \-timeline $_Match_Longest_$Activity_
POP3Server1 agent.config \-Server_Listening_Port 110 \-enable
true \-name "POP3Server1" \-vlanPriority
0 \-concurrentSessionLimit 1000 \-enableVlanPriority
true$Activity_POP3Server1 agent.mailMessageList.clearset Simple [::IxLoad new
MailMessage]$Simple config \-bodySizeType 0 \-name
"Simple" \-fileNameAsBody "" \-description "" \-
"100 bytes plain text body" \-textContentAsBody "" \-
bodySizeRandomMax 4096 \-bodySizeFixed
100 \-mimeTypeAndEncode 0 \-bodySizeRandomMin
1 \-bodyDataType 0 \-useFileAsBody
true \-bodyFormat 0$Simple headerList.clearset From
[::IxLoad new MailHeader]$From config \-name
"From" \-value "fromName@company.com"$Simple head-
erList.appendItem -object $Fromset To [::IxLoad new MailHeader]$To config \-name
"To" \-value "toName@company.com"$Simple head-
erList.appendItem -object $Toset Subject [::IxLoad new MailHeader]$Subject config \-
name "Subject" \-value
"sample subject"$Simple headerList.appendItem -object $Subject$Simple attach-
mentList.clear$Activity_POP3Server1 agent.mailMessageList.appendItem -object $Simple
```

### SEE ALSO

[ixNetTraffic](#)

[MailBoxItem](#)

## MailBoxItem

MailBoxItem—Specifies the contents of a mail box.

### SYNOPSIS

```
set Traffic2_Network2 [::IxLoad new ixNetTraffic]
set Activity_POP3Server1 [$Traffic2_Network2 activityList.appendItem
$Activity_POP3Server1 agent.mailBox.appendItem -object $my_MailBoxItem
set my_MailBoxItem [::IxLoad new MailBoxItem]
```

### DESCRIPTION

A MailBoxItem object is added to the mailBox option of the POP3 Server Agent object using the appendItem subcommand from the ixConfigSequenceContainer command.

### SUBCOMMANDS

The options for this command are configured and read using the standard config, cget, and getOptions subcommands defined in the ixConfig command.

### OPTIONS

count

The number of copies of the mail message detained in mailMessage to be returned. (Default = 10).

### SUB-OBJECTS

mailMessage

An object of type MailMessage which contains the message to be returned to the POP3 user. (Default = {}).

### EXAMPLE

```
set my_MailBoxItem [::IxLoad new MailBoxItem]$my_MailBoxItem config \-count
10 \-mailMessage $Simple1$Activity_POP3Server1 agent.-
mailBox.appendItem -object $my_MailBoxItem
```

### SEE ALSO

[POP3 Server Agent](#)

## Using Auto-Generated Strings

In some of the fields in the POP3 and SMTP client and server Activities, you can use sequence generators to automatically generate multiple values for the field. For example, the POP3 Username and Password fields both support the inclusion of variables.

See [Using Automatic Sequence Generators](#).



## POP3 Statistics

The test results are available from the location defined on the User Directories window. See User Directories.

If you review your statistics and find many instances of POP3 Client statistics and server statistics that should match but do not, that may be an indication that the Ramp Down Time is too short. When the Ramp Down Time expires, IxLoad terminates any users that are still running. If those users still have work in progress (such as transferring data) when IxLoad terminates them, the work will not be completed and the effect will be that statistics that should match may not.

For TCP statistics, see [TCP, Run State, and Curve Segment Statistics](#).

For the POP3 statistics, see the following:

[POP3 Client Statistics](#)

[POP3 Server Statistics](#)

## POP3 Client Statistics

The table below lists the statistics that IxLoad reports for POP3 clients. Statistics in the results files and reports are averaged over all ports. If a statistic for an interval is missing, IxLoad interpolates it from the statistic immediately prior to it and the statistic after it.

For TCP statistics, see [TCP, Run State, and Curve Segment Statistics](#).

Statistic	Description
POP3 Simulated Users	Number of simulated POP3 users.
POP3 Concurrent Connections	Maximum number of concurrent POP3 connections maintained during the test.
POP3 Connections	Number of POP3 sessions established by the clients.
POP3 Transactions	Number of POP3 transactions completed by the clients.
POP3 Bytes	Number of POP3 bytes transmitted and received by the clients.
POP3 Sessions Requested	Number of POP3 sessions attempted by the clients.
POP3 Sessions Established	Number of POP3 sessions established by the clients.
POP3 Sessions Failed	Number of attempts to establish POP3 sessions that failed.
POP3 Mails Received	Number of mail messages retrieved by the clients using POP3.
POP3 Authentication Sent	Number of POP3 authentication messages sent by the clients.
POP3 Authentication Ok	Number of authentication messages which resulted in the servers allowing access.

POP3 Authentication Failed	Number of authentication messages which resulted in the servers denying access.
POP3 LIST Sent	Number of POP3 LIST commands sent.
POP3 LIST Ok	Number of POP3 LIST commands that received a positive response. If an argument was given with the command, the POP3 server issues a response with a line containing information for the message specified by the argument. If no argument was given, the POP3 server issues a multi-line response.
POP3 LIST Failed	Number of POP3 LIST commands that did not receive a positive response.
POP3 STAT Sent	Number of POP3 STAT messages sent.
POP3 STAT Ok	Number of POP3 STAT commands that received a positive response. A positive response to this command consists of +OK followed by a single space, the number of messages in the maildrop, a single space, and the size of the maildrop in octets.
POP3 STAT Failed	Number of POP3 STAT commands that did not receive a positive response.
POP3 RETR Sent	Number of POP3 RETR messages sent.
POP3 RETR Ok	Number of POP3 RETR messages that received a positive response. A positive response to this command consists of an initial +OK followed by the message corresponding to the given message-number.
POP3 RETR Failed	Number of POP3 RETR commands that did not receive a positive response.
POP3 DELE Sent	Number of POP3 DELE commands sent.
POP3 DELE Ok	Number of POP3 DELE messages that received a positive response. In a positive response to this message, the POP3 server marks the message as deleted.
POP3 DELE Failed	Number of POP3 DELE commands that did not receive a positive response.

POP3 UIDL Sent	Number of POP3 UIDL commands sent.
POP3 UIDL Ok	Number of POP3 UIDL messages that received a positive response. If an argument was given, a positive response to this command consists of a line containing information for the message passed as the argument. If no argument was given, a positive response consists of an initial +OK followed by multiple lines, each line containing information for one message in the maildrop.
POP3 UIDL Failed	Number of POP3 UIDL commands that did not receive a positive response.
POP3 RSET Sent	Number of POP3 RSET messages sent.
POP3 RSET Ok	Number of POP3 RSET messages that received a positive response.
POP3 RSET Failed	Number of POP3 RSET commands that did not receive a positive response.
POP3 NOOP Sent	Number of POP3 NOOP messages sent.
POP3 NOOP Ok	Number of POP3 NOOP messages that received a positive response.
POP3 NOOP Failed	Number of POP3 NOOP commands that did not receive a positive response.
POP3 TOP Sent	Number of POP3 TOP messages sent.
POP3 TOP Ok	Number of POP3 TOP messages that received a positive response. A positive response consists of the initial +OK followed by the headers of the message, the blank line separating the headers from the body, and then the number of lines indicated message's body.
POP3 TOP Failed	Number of POP3 TOP messages that did not receive a positive response.
POP3 QUIT Sent	Number of POP3 QUIT messages sent.
POP3 QUIT Ok	Number of POP3 QUIT messages that received a positive response.
POP3 QUIT Failed	Number of POP3 QUIT messages that did not receive a positive response.

POP3 Total Bytes Sent	Total number of POP3-related bytes (commands, responses, and messages) sent by the clients.
POP3 Total Bytes Received	Total number of POP3-related bytes (commands, responses, and messages) received by the clients.
POP3 Mail Bytes Received	Total number of bytes contained in the mail messages retrieved using POP3.
POP3 Sessions Active	Total number of POP3 sessions in progress.
POP3 Connection Rate	Rate at which the POP3 client established connections to the server.
POP3 Transaction Rate	Rate at which the POP3 client completed transactions.
POP3 Concurrent Connections	Number of POP3 connections active at the same time.
POP3 Simulated Users	Number of simulated POP3 users.
POP3 Throughput	Rate at which the client sent and received POP3 data.



**Note:** If the average table and bar graphs do not contain any data for the clients, that is an indication that they did not reach the Sustained (SU) run state. This can be caused by the following:

1. Stopping a test during the Ramp-Up phase.
2. Configuring a large number of page requests for the client agent so that not all the users configured for the client can attain the SU state within the allotted time.
3. Configuring a value for the statistics interval (Statistics tab) which is much larger than the SU time.

## POP3 Server Statistics

The table below lists the statistics that IxLoad reports for POP3 servers. Statistics in the results files and reports are averaged over all ports. If a statistic for an interval is missing, IxLoad interpolates it from the statistic immediately prior to it and the statistic after it.

For TCP statistics, see [TCP, Run State, and Curve Segment Statistics](#).

Statistic	Description
POP3 Session Requests Received	Number of requests to establish POP3 sessions received by the servers.
POP3 Session Requests Successful	Number of POP3 sessions established by the servers.
POP3 Session Requests Failed	Number of POP3 sessions requested by the clients that the servers failed to establish.
POP3 Total Mails Sent	Total number of mail messages sent by the servers.
POP3 Total Attachments Sent	Total number of attachments sent by the servers.
POP3 Total Mails With Attachments Sent	Total number of messages sent that included one or more attachments.
POP3 USER Cmds Received	Number of POP3 USER commands received.
POP3 PASS Cmds Received	Number of POP3 PASS commands received.
POP3 APOP Cmds Received	Number of POP3 APOP commands received.
POP3 LIST Cmds Received	Number of POP3 LIST commands received.
POP3 STAT Cmds Received	Number of POP3 STAT commands received.
POP3 RETR Cmds Received	Number of POP3 RETR commands received.
POP3 DELE Cmds Received	Number of POP3 DELE commands received.
POP3 UIDL Cmds Received	Number of POP3 UIDL commands received.
POP3 RSET Cmds Received	Number of POP3 RSET commands received.
POP3 NOOP Cmds Received	Number of POP3 NOOP commands received.
POP3 TOP Cmds Received	Number of POP3 TOP commands received.

---

POP3 QUIT Cnds Received	Number of POP3 QUIT commands received.
POP3 Total Bytes Sent	Total number of POP3-related bytes (commands, responses, and messages) sent by the servers.
POP3 Total Bytes Received	Total number of POP3-related bytes (commands, responses, and messages) received by the servers.

This page intentionally left blank.



## Published Vulnerabilities and Malware

This section describes the Tcl API for the Published Vulnerabilities and Malware plugin.

The protocol type for this plugin is "Vulnerability Peer":

```
set Activity_PublishedVulnerabil1 [$Traffic1_Network1 activityList.appendItem \  
-protocolAndType          "Vulnerability Peer" ]
```

The valid objective types for this plugin are are:

- peerCount
- throughputMBps
- throughputKBps

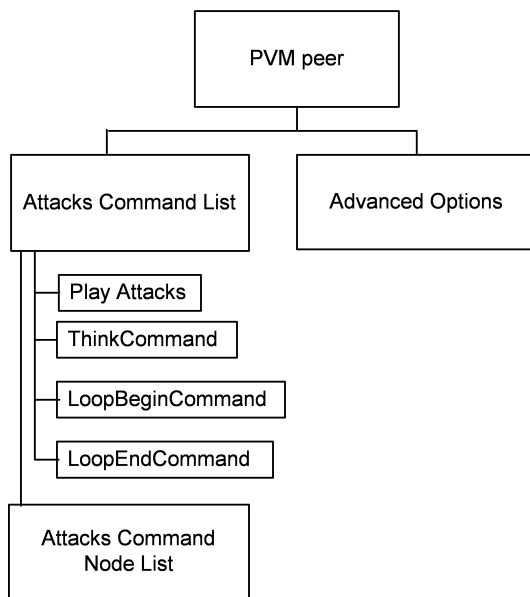

## config

Published Vulnerability Peer - create a Published Vulnerability peer

### SYNOPSIS

```
set Activity_PublishedVulnerabil1 [$Traffic1_Network1 activityList.appendItem \  
-protocolAndType          "Vulnerability Peer" ]  
$Activity_PublishedVulnerabil1 playlists.clear  
$Activity_PublishedVulnerabil1 config \  
-enable                    true \  
-name                      "PublishedVulnerabil1" \  

```

### DESCRIPTION

A Published Vulnerability and Malware peer agent is added to the `activityList` option of the `ixNetTraffic` object using the `appendItem` subcommand from the `ixConfigSequenceContainer` command. Other `ixConfigSequenceContainer` subcommands may be used to modify the `agentList`. It is customary to set all the options of the client agent during the `appendItem` call.

Each member of the list, however may be separately addressed and modified using the `ixConfig` subcommands.

### SUBCOMMANDS

The options for this command are configured and read using the standard `config`, `cget`, and `getOption` subcommands defined in the `ixConfig` command.

### OPTIONS

`enable`

Enables the use of this peer agent. (Default = true).

`name`

The name associated with this object, which must be set at object creation time.

### STATISTICS

### EXAMPLE

```
set Activity_PublishedVulnerabil1 [$Traffic1_Network1 activityList.appendItem \  

```

```
-protocolAndType          "Vulnerability Peer" ]
$Activity_PublishedVulnerabil1 playlists.clear
$Activity_PublishedVulnerabil1 config \
-enable                   true \
-name                    "PublishedVulnerabil1" \
-userIpMapping           "1:1" \
-enableConstraint        false \
-userObjectiveValue      100 \
-constraintValue        100 \
-userObjectiveType       "peerCount" \
-timeline                $Timeline1

$Activity_PublishedVulnerabil1 agent.config \
-cmdListLoops            0
```

**SEE ALSO**

ixNetTraffic

## advOptions

advOptions - configure the advanced options of a Published Vulnerabilities and Malware peer

### SYNOPSIS

```
$Activity_PublishedVulnerabil1 agent.pm.advOptions.config \  
-sessionTimeout          10 \  
-enableAdvanceStats      false
```

### DESCRIPTION

This command configures the advanced options of a Published Vulnerabilities and Malware peer.

### SUBCOMMANDS

The options for this command are configured and read using the standard `config`, `cget`, and `getOption` subcommands defined in the `ixConfig` command.

### OPTIONS

`sessionTimeout`

Configures the session timeout value. (Default="10", min="1", max="3600").

`enableAdvanceStats`

Enables or disables advanced statistics. (Default="0 (false)).

### STATISTICS

### EXAMPLE

```
$Activity_PublishedVulnerabil1 agent.pm.advOptions.config \  
-sessionTimeout          10 \  
-enableAdvanceStats      false
```

### SEE ALSO

`ixNetTraffic`

## attacksCmdList

attacksCmdList - configure a Published Vulnerability peer command list

### SYNOPSIS

```
$Activity_PublishedVulnerabil1 agent.pm.attacksCmdList.appendItem \  
-commandType          "PlayAttacks" \  
-
```

### DESCRIPTION

This command configures the list of commands that Published Vulnerability and Malware peer initiator agent will execute during a test. You should clear the command list before you begin adding commands to it.

Add commands to the list using the `appendItem` subcommand from the `ixConfigSequenceContainer` command. Other `ixConfigSequenceContainer` subcommands may be used to modify the list. It is customary to set all the options for the command during the `appendItem` call.

Each member of the list can be separately addressed and modified using the `ixConfig` subcommands.

### SUBCOMMANDS

The options for this command are configured and read using the standard `config`, `cget`, and `getOption` subcommands defined in the `ixConfig` command.

### OPTIONS

`commandType`

Type of command to be added to list. Commands can be one of the following:

#### PlayAttacks

Plays list of attacks.

Options for PlayAttacks are:

`destination`

Responder peer that is the destination of this PlayAttacks command.

`attackList`

Name of attack list to be executed. This must be the name string as displayed in the GUI.

`cmdName`

Name of this command.

## LoopBeginCommand

Marks the beginning of a subset of commands that will be looped through in command list.

Options for LoopBeginCommand are:

LoopCount

Number of times to loop the subset of commands. (Default="5," min="0", max="2147483647")

## LoopEndCommand

Marks the end of a subset of commands that will be looped through in command list.

There are no options for LoopEndCommand.

## THINK

Pauses execution of command list.

Options for THINK are:

minimumInterval

Minimum length of time to pause execution. (Min="1", max="2147483647", default="1000")

maximumInterval

Maximum length of time to pause execution. (Min="1", max="2147483647", default="1000")

## EXAMPLE

```
$Activity_PublishedVulnerabil1 agent.pm.attacksCmdList.clear
```

```
$Activity_PublishedVulnerabil1 agent.pm.attacksCmdList.appendItem \
```

```
-commandType          "PlayAttacks" \
```

```
-destination          "Traffic2_PublishedVulnerabil2" \
```

```
-attackList           "All attacks" \
```

```
-cmdName              "Play Attacks 1"
```

## SEE ALSO

## attacksCmdList nodeList

attacksCmdList nodeList - configure the list of evasion methods associated with a command list.

### SYNOPSIS

```
$Activity_PublishedVulnerabil1 agent.pm.attacksCmdList(0).nodeList.appendItem \
-id                               "NodeIpFragmentReorder" \
```

### DESCRIPTION

This command configures the list of evasion techniques associated with a specific command list. You should clear the command list before you begin adding commands to it.

Add methods to the list using the `appendItem` subcommand from the `ixConfigSequenceContainer` command. Other `ixConfigSequenceContainer` subcommands may be used to modify the list. It is customary to set all the options for the method during the `appendItem` call.

Each member of the list can be separately addressed and modified using the `ixConfig` subcommands.

### SUBCOMMANDS

The options for this command are configured and read using the standard `config`, `cget`, and `getOption` subcommands defined in the `ixConfig` command.

### OPTIONS

id

Evasion method. `id` can be one of the following

#### NodeIpFragmentGlobal

Global options for the IP fragmentation evasion technique.

Options for `NodeIpFragmentGlobal` are:

`checkBoxState`

Enables or disables IP fragmentation for packets with specific flags set. (Default = false)

`ack`

If True, packets with the ACK flag set are not fragmented. (Default = false)

`synAck`

If True, packets with the SYN/ACK flag set are not fragmented. (Default = false)

`syn`

If True, packets with the SYN flag set are not fragmented. (Default = false)

ackPsh

If True, packets with the ACK/PSH flag set are not fragmented. (Default = false)

rst

If True, packets with the RST flag set are not fragmented. (Default = false)

size

Size of the fragments. Must be a multiple of 8. (Default="8", min="8", max="9000")

### **NodeIpFragmentReorder**

Fragment reorder evasion technique.

Options for NodeIpFragmentReorder are:

checkBoxState

If True, IP fragments are reordered. (Default = false)

reorder

Reorder method. (Random = 1, Reverse = 2, Default = 1)

### **NodeIpFragmentOverlap**

Fragment overlap evasion technique.

Options for NodeIpFragmentOverlap are:

checkBoxState

If True, IP fragments are overlapped. (Default = false)

overlap

Area of fragments that overlap. (Last X bytes = 1, First X bytes = 2, Default = 2)

overlapLength

Length, in bytes, of overlapping area. Must be a multiple of 8 and less than the IP Fragment size. (Default="8" min="8" max="9000")

### **NodeIpFragmentInsertNull**

Null fragment insertion evasion technique.

Options for NodeIpFragmentInsertNull are:

checkBoxState

If True, null fragments are inserted. (Default = false)



hopCount

Number of hops on the network to reach the DUT. (Min="1", max="256", default="1")

insertNull

Location where null fragments are inserted. (Before each fragment = "1", After each fragment = "2", default = "2")

### NodeIpFragmentDuplicate

Duplicate fragment evasion technique.

Options for NodeIpFragmentDuplicate are:

checkBoxState

If True, fragments are duplicated. (Default = false)

duplicate

Enables or disables fragment duplication. (Enable = "1", Disable = "2", default = 2)

### EXAMPLE

```
$Activity_PublishedVulnerabil1 agent.pm.attacksCmdList(0).nodeList.clear
```

```
$Activity_PublishedVulnerabil1 agent.pm.attacksCmdList(0).nodeList.appendItem \
```

```
-id "NodeIpFragmentGlobal" \
```

```
-checkBoxState false \
```

```
-ack false \
```

```
-synAck false \
```

```
-syn false \
```

```
-ackPsh false \
```

```
-rst false \
```

```
-size 8
```

```
$Activity_PublishedVulnerabil1 agent.pm.attacksCmdList(0).nodeList.appendItem \
```

```
-id "NodeIpFragmentReorder" \
```

```
-checkBoxState false \
```

-reorder 1

**SEE ALSO**

## AddAttacks

AddAttacks - add attacks to an attack list

### SYNOPSIS

```
agent.CallServiceEx "AddAttacks" [list "AttackListName", "attackName1", "attackName2", "at-  
tackName3"...]
```

### DESCRIPTION

AddAttacks adds one or more attacks to an existing attack list. This command returns no values.

### SUBCOMMANDS

The options for this command are configured and read using the standard `config`, `cget`, and `getOptions` subcommands defined in the `ixConfig` command.

### OPTIONS

Attack list name

Name of the list to which attacks are to be added. Default="" (none).

attack names

Comma-separated list of the attacks to be added to the list. Default="" (none).

### EXAMPLE

```
$VulnActivity agent.callServiceEx "AddAttacks" /  
[list "3623-all" "Backdoor_Win32_Redsip_A_runtime1"]
```

### SEE ALSO

## AttackListCount

AttackListCount - find the number of attacks in an attack list

### SYNOPSIS

```
agent.CallServiceEx "AttackListCount" [list "attackListName"]
```

### DESCRIPTION

AttackListCount returns the number of attacks in a list. This command returns a list in which the first element is the number of attacks in the list.

### SUBCOMMANDS

The options for this command are configured and read using the standard config, cget, and getOptions subcommands defined in the ixConfig command.

### OPTIONS

AttackListName

Name of the attack list. Default = "" (none).

### EXAMPLE

```
$VulnActivity agent.callServiceEx "AttackListCount" [list "All attacks"]
```

### SEE ALSO

## CreateAttackList

CreateAttackList - create a new list of attacks

### SYNOPSIS

```
agent.CallServiceEx "CreateAttackList" [list "AttackListName", "attackName1", "attackName2"...]
```

### DESCRIPTION

CreateAttackList creates a new list of attacks. This command returns no values.

### SUBCOMMANDS

The options for this command are configured and read using the standard `config`, `cget`, and `getOption`s subcommands defined in the `ixConfig` command.

### OPTIONS

Attack list name

Name of the list to be created. Default="" (none).

attack names

Comma-separated list of the attacks to be included in the list. Default="none".

### EXAMPLE

```
$VulnActivity agent.callServiceEx "CreateAttackList" /  
[list "list new2" "Backdoor_Win32_Redsip_A_runtime1" /  
"Adobe Acrobat and Reader 'AcroForm.api' /  
Memory Corruption Vulnerability"]
```

### SEE ALSO

## CreatePlaylist

CreatePlaylist - create a playlist

### SYNOPSIS

```
agent.CallServiceEx "CreatePlaylist" [list "attackListName", "filter", "filePath" "type"]
```

### DESCRIPTION

CreatePlaylist creates a playlist of attack lists. This command returns no values.

### SUBCOMMANDS

The options for this command are configured and read using the standard config, cget, and getOptions subcommands defined in the ixConfig command.

### OPTIONS

attackListName

Name of the new attack. Default = "" (none).

filter

Filter criteria used to add attacks to the list. Default = "" (none).

filePath

Name and full directory path of the playlist file.

type

Type of match to the filter criteria. If True, the filter criteria must be an exact match. If False (the default), the filter criteria can be a partial match.

### EXAMPLE

```
$VulnActivity agent.callServiceEx "CreatePlaylist" [list cve2010 "cveid" C:/cve_playlist.txt False]
```

### SEE ALSO

## DatabaseVersion

DatabaseVersion - return the version number of the attacks database

### SYNOPSIS

```
agent.DatabaseVersion "DatabaseVersion" []
```

### DESCRIPTION

DatabaseVersion returns the version number of the attacks database. This command returns a list in which the first element is the database version number.

### SUBCOMMANDS

The options for this command are configured and read using the standard config, cget, and getOptions subcommands defined in the ixConfig command.

### OPTIONS

None.

### EXAMPLE

```
agent.DatabaseVersion "DatabaseVersion" []
```

### SEE ALSO

## DeleteAttackList

DeleteAttackList - delete an attack list

### SYNOPSIS

```
agent.CallServiceEx "DeleteAttackList" [list "AttackListName"]
```

### DESCRIPTION

DeleteAttackList deletes a list of attacks. This command returns no values.

### SUBCOMMANDS

The options for this command are configured and read using the standard `config`, `cget`, and `getOption` subcommands defined in the `ixConfig` command.

### OPTIONS

AttackListName

Name of the list to be deleted. Default="" (none).

### EXAMPLE

```
$VulnActivity agent.callServiceEx "DeleteAttackList"[list "list new2"]
```

### SEE ALSO



## DeleteAttacks

DeleteAttacks - delete attacks from an attack list

### SYNOPSIS

```
agent.CallServiceEx "DeleteAttacks" [list "AttackListName, "attackName1,attackName2"..."]
```

### DESCRIPTION

DeleteAttacks removes attacks from an attack list. This command returns no values.

### SUBCOMMANDS

The options for this command are configured and read using the standard `config`, `cget`, and `getOption`s subcommands defined in the `ixConfig` command.

### OPTIONS

Attack list name

Name of the list from which attacks are to be removed. Default="" (none).

attack names

Comma-separated list of the attacks to be removed from the list. Default="" (none).

### EXAMPLE

```
$VulnActivity agent.callServiceEx "DeleteAttacks" [list "3623-all" "Youngzsoft_CCProxy_CONNECT_Request_Buffer_Overflow_attack" ]
```

### SEE ALSO

## ExportAttacks

ExportAttacks - export attack list

### SYNOPSIS

```
agent.CallServiceEx "ExportAttacks" ["attackListName","filepath"]
```

### DESCRIPTION

ExportAttacks exports an attack list to a .zatk format file. This command returns no values.

### SUBCOMMANDS

The options for this command are configured and read using the standard config, cget, and getOptions subcommands defined in the ixConfig command.

### OPTIONS

attackListName

Name of the attack list to be exported. Default = "" (none).

filepath

Full path where the file of exported attacks will be stored. Default = "" (none).

### EXAMPLE

```
$VulnActivity agent.callServiceEx "ExportAttacks" [list "one" "C:/attack_list.zatk"]
```

### SEE ALSO

## GetCapture

GetCapture - return the name of the capture file associated an attack

### SYNOPSIS

```
$VulnActivity agent.callServiceEx "GetCapture" "Backdoor_Win32_Redsip_A_runtime1"
```

### DESCRIPTION

GetCapture returns the name of the capture file associated an attack. This command returns a list in which the first element is the name of the capture file.

### SUBCOMMANDS

The options for this command are configured and read using the standard config, cget, and getOptions subcommands defined in the ixConfig command.

### OPTIONS

AttackName

Name of the attack for which the capture is to be returned. Default = "" (none).

### EXAMPLE

```
$VulnActivity agent.callServiceEx "GetCapture" "Backdoor_Win32_Redsip_A_runtime1"
```

### SEE ALSO

## ImportAttacks (.zatk format)

ImportAttacks - import attacks in .zatk format

### SYNOPSIS

```
agent.CallServiceEx "ImportAttacks" ["file_path_of_the_zatk_file"]
```

### DESCRIPTION

ImportAttacks imports user-defined attacks stored in .zatk files into the database. This command returns no values.

### SUBCOMMANDS

The options for this command are configured and read using the standard config, cget, and getOptions subcommands defined in the ixConfig command.

### OPTIONS

file\_path\_of\_the\_zatk\_file

Full file path where the .zatk file is stored. Default = "" (none).

### EXAMPLE

```
$VulnActivity agent.callServiceEx "ImportAttacks" [list "C:/AttacksToImport"]
```

### SEE ALSO

## ImportUserDefinedAttacks

ImportUserDefinedAttacks - import attacks

### SYNOPSIS

```
agent.CallServiceEx "ImportUserDefinedAttacks" ["folder_path", "importType"]
```

### DESCRIPTION

ImportUserDefinedAttacks imports user-defined attacks into the database. This command returns no values.

### SUBCOMMANDS

The options for this command are configured and read using the standard `config`, `cget`, and `getOption`s subcommands defined in the `ixConfig` command.

### OPTIONS

`folder_path`

Full directory path where the capture files and XML metadata files are stored. Default = "" (none).

`importType`

Determines what happens if the imported attacks already exist in the database. If True, the imported attacks overwrite the existing attacks. If False (the default), the imported attacks are added as new attacks.

### EXAMPLE

```
$VulnActivity agent.callServiceEx "ImportUserDefinedAttacks" [list "C:/Vijay" "False"]
```

### SEE ALSO

## RenameAttackList

RenameAttackList - rename an attack list

### SYNOPSIS

```
agent.CallServiceEx "RenameAttackList" [list "AttackListName" "NewAttackListName"]
```

### DESCRIPTION

RenameAttackList renames an attack list. This command returns no values.

### SUBCOMMANDS

The options for this command are configured and read using the standard config, cget, and getOptions subcommands defined in the ixConfig command.

### OPTIONS

AttackListName

Current name of the attack list. Default = "" (none).

NewAttackListName

New name of the attack list. Default = "" (none).

### EXAMPLE

```
agent.CallServiceEx "RenameAttackList" [list "AttackListName" "NewAttackListName"]
```

### SEE ALSO

## RetrieveAttacks

RetrieveAttacks - retrieve the list of attacks in an attack list

### SYNOPSIS

```
Agent.CallServiceEx "RetrieveAttacks" [list "attackListName"]
```

### DESCRIPTION

RetrieveAttacks retrieves the list of attacks in an attack list This command returns a list which consists of the names of the attacks in the list.

### SUBCOMMANDS

The options for this command are configured and read using the standard config, cget, and getOptions subcommands defined in the ixConfig command.

### OPTIONS

attackListName

Name of the new attack. Default = "" (none).

### EXAMPLE

```
$VulnActivity agent.callServiceEx "RetrieveAttacks" [list "2"]
```

### SEE ALSO

## SearchAttacks

SearchAttacks - search for attacks

### SYNOPSIS

```
agent.CallServiceEx "SearchAttacks" {"valueToBeSearched", "metadataToBeSearched", "isCaseSensitive", "isExactMatch",}
```

### DESCRIPTION

SearchAttacks searches for attacks in the database, based on criteria you supply in the command. This command returns a list of attacks that match the criteria you entered.

Note that the parameters for this command are bounded by braces ( { } ) instead of square brackets ( [ ] ) as for the other PVM commands.

### SUBCOMMANDS

The options for this command are configured and read using the standard `config`, `cget`, and `getOptions` subcommands defined in the `ixConfig` command.

### OPTIONS

`valueToBeSearched`

Value to search for. Default = "" (none).

`metadataToBeSearched`

Metadata to search. Default = "" (none).

`isCaseSensitive`

Determines whether the match should be case-sensitive or not. Values = "True", "False" (default).

`isExactMatch`

Determines whether the match should be a sub-string or an exact match. `isExactMatch` is a filter that will return the attack only if the `metadataToBeSearched` value is equal with `valueToBeSearched`. Values = "True", "False" (default).

### EXAMPLE

```
$VulnActivity agent.callServiceEx "SearchAttacks" {"HIGH" "Severity" True True}
```

### SEE ALSO



! 25

This page intentionally left blank.

## QT

This section describes the QT Tcl API commands.

## Running a QuickTest from Tcl

To run a Quick Test from a Tcl script, you use the IxLoad GUI to configure a Quick Test in an RXF, then you use a TCL script to load the RXF and start the test.

For an example of a Tcl script, see [Quick Test Sample Script](#).

Also, a sample Quick Test Tcl script is included in the `<install path>TclScripts\Samples\Application Features` directory. To run this script, set the Windows environment variable `IXLOAD_TCLAPI_REV` to the value of installation folder of the IxLoad version you intend to use. For example: `C:\Program Files (x86)\Ixia\IxLoad\<version>\.`

After setting the environment variable, use the following procedure to run the script:

1. Open a Windows command prompt.
2. Set the path to the Application Features directory of the version of IxLoad you want to use.
3. For example: `C:\Program Files (x86)\Ixia\IxLoad\version\TclScripts\Samples\Application Features`
4. Type the full path to the Ixia Tcl shell (`tclsh.exe`), specify the the tcl file (file name only), and the full path to the RXF containing the QuickTest, the press Enter to start the script.

For example:

<code>"&lt;path&gt;\Tcl\8.5.12.0\bin\tclsh.exe"</code>	<code>RunQT.tcl</code>	<code>"D:\TCL\Demo\demo.rxf"</code>
<code>[ full path to the TCL shell]</code>	<code>[script]</code>	<code>[full path to rxf file]</code>

## startQuickTest

startQuickTest - start a Quick Test

### SYNOPSIS

```
startQuickTest "TestName"
```

### DESCRIPTION

This command starts a Quick Test. Run the command against the QuickTest Config object (`$qtConfig`), and specify the test to be started.

### SUBCOMMANDS

None.

### OPTIONS

TestName

Name of the Quick Test to run. If you do not specify a test, the command runs the first QuickTest configured in the RXF.

Default = "" (none)

### EXAMPLE

```
$qtConfig startQuickTest "QuickTest1"
```

### SEE ALSO

## checkTestRunning

checkTestRunning - confirm test is running

### SYNOPSIS

checkTestRunning

### DESCRIPTION

This command checks to see if a Quick Test is running. Run the command against the QuickTest Config object (`$qtConfig`).

### SUBCOMMANDS

None.

### OPTIONS

None

### EXAMPLE

```
$qtConfig checkTestRunning
```

### SEE ALSO

## stopQuickTest

stopQuickTest - stop a running Quick Test

### SYNOPSIS

stopQuickTest

### DESCRIPTION

This command forcefully stops a running Quick Test. Run the command against the QuickTest Config object (`$qtConfig`).

### SUBCOMMANDS

None.

### OPTIONS

None

### EXAMPLE

```
$qtConfig stopQuickTest
```

### SEE ALSO

## QuickTest Sample Script

Below is a sample Quick Test Tcl script you can use as a basis for your own script.

To use this script:

1. Create a new Quick TestT test using the IxLoad GUI, assign ports to it, and then save the RXF in the same folder as the script. For example, `D:\TCL\Demo`).
2. In the folder where you saved the RXF and script, create a sub-folder to store the results in (for example: `D:\TCL\Demo\Results`).
3. Change the paths in the script to match the paths where you saved the RXF and script, and created the results folder.
4. To run the script, open a Wish console and source the file.

For example: `source {D:\TCL\Demo\run_qt.tcl}`

```
#package require IxLoad
package require IxLoadCsv

# #####

# Connect
::IxLoad connect localhost

# Incarcare rxf
set testController [::IxLoad new ixTestController -outputDir 1]
$testController setResultDir {D:\TCL\Demo\Results}
set repository [::IxLoad new ixRepository -name {D:\TCL\Demo\demo.rxf}]

# Start QT
set qtConfig [$repository getQuickTestConfig]
after 12000
$qtConfig startQuickTest "QuickTest1"

# Check test is running
set timeIni [clock seconds]
while { [$qtConfig checkTestRunning] } {
    after 1
    set elapsed [expr [clock seconds] -$timeIni]
    #puts "Elapsed $elapsed seconds"
}

# Disconnect
$testController releaseConfigWaitFinish
```





This page intentionally left blank.

# Radius

This section describes the Radius Tcl API objects.

## Overview

The IxLoad Radius API consists of a client agent and its commands, structured as shown below.

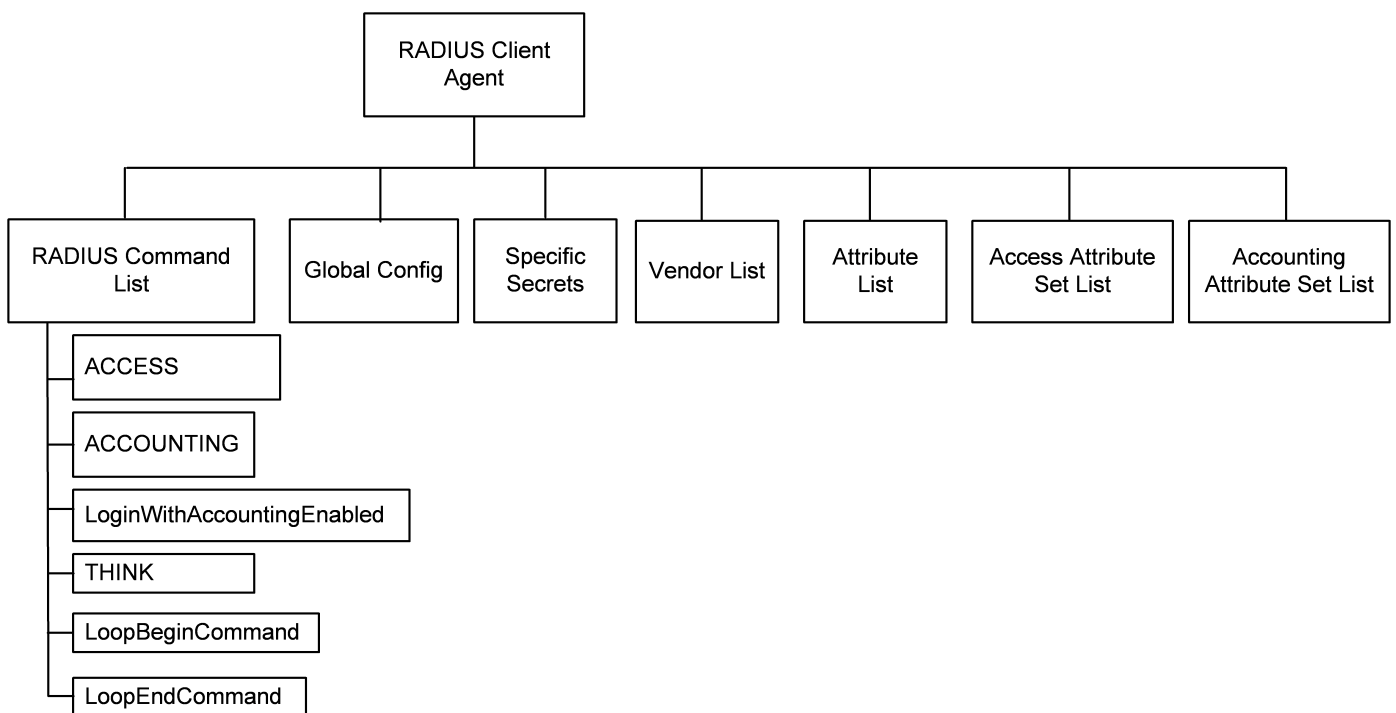

## Objectives

The objectives (userObjective) you can set for Radius are listed below. Test objectives are set in the ixTimeline object.

- transactionRate
- simulatedUsers
- concurrentSessions

## Radius Client Agent

The Radius Client Agent simulates user requests for access by sending user names and passwords to a RADIUS server, and recording the responses returned by the server. Refer to `Radius Client Agent` on page 25-5 for a full description of this command. The most significant options of this command are listed below.

Option	Description
protocolAndType	Protocol used by the client agent. Defines the agent as either a client or server.

## Radius Command List

The Radius Command List creates the list of Radius commands that the client will send to a Radius server. Refer to `Radius Command List` on page 25-11 for a full description of this command. The most significant options of this command are listed below.

Option	Description
id	Command that client will send.

## Global Config

The Global Config contains the parameters that define the way the IxLoad RADIUS client performs overall. Refer to `Global Config` on page 25-16 for a full description of this command. The most significant options of this command are listed below.

Option	Description
defaultAuthentica	The UDP port on the RADIUS server to which the IxLoad client sends Access-Requests.
defaultAccounting	The UDP port on the RADIUS server to which the IxLoad client sends Accounting-Requests.
authenticationRe	Number of times the IxLoad RADIUS client will re-send an unacAccess-Request. If the RADIUS server does not respond to an Access-Request within the Response Timeout period, the client resends the Access-Request.
responseTimeouot	Elapsed time, in seconds, allowed for the server to respond to a clirequest.
defaultSharedSe	Secret used if no server-specific secret is configured. To configure server-specific secrets, see <a href="#">Creating and Editing Server-Specific Shared Secrets</a> on page 23-13.
send_ACCOUNTING_REQUESTS_when_ACCESS_REQUEST_are_pending	Enabled: If enabled, the IxLoad client requests accounting data even if requests for authentication (Access-Requests) are still pend Disabled: If disabled, the IxLoad client does not send Accounting-data if any Access-Requests are pending.
maxPendingRe	Maximum number of pending requests per client that the IxLoad climaintains with the RADIUS server.

## Specific Secrets

To configure secrets to be used with specific servers. Refer to [Specific Secrets](#) on page 25-18 for a full description of this command. The options supported are listed below.

Option	Description
sharedSecretList	The list of shared secrets to be used with specific servers.

## Vendor List

The Vendors tab contains the predefined vendors and their vendor-codes that the IxLoad client uses. You cannot modify or delete the predefined vendors and codes, but you can add additional vendors and codes. Refer to `Vendor List` on page 25-19 for a full description of this command. `Attribute List`

The Attributes list contains the predefined Attributes, their values, and the venthat originally specified them. All the predefined Attributes are standard RADIUS Attributes; there are no vendor-specific Attributes in the list. Refer to `Attribute List` on page 25-20 for a full description of this command.

## Access Attribute Set List

Access Attribute sets are groups of Access Attributes that are included in RADIUS messages. Refer to `AccessAttribSetList` on page 25-22 for a full description of this command. The most significant options of this command are listed below.

Option	Description
id	This represents the name of the ACCESS attribute set.

## Accounting Attribute Set List

Accounting Attribute sets are groups of Accounting Attributes that are included in RADIUS messages. Refer to `AcctngAttribSetList` on page 25-23 for a full description of this command. The most significant options of this command are listed below.

Option	Description
acctngAttribVal	This represents the name of the ACCOUNTING attribute set.

## Radius Client Agent

Radius Client Agent - create a Radius client

### SYNOPSIS

```
set Traffic1_Network1 [::IxLoad new ixNetTraffic]
set Activity_RADIUSClient1 [$Traffic1_Network1 activityList.appendItem options...]
$Activity_RADIUSClient1 agent.config
```

### DESCRIPTION

The Radius Client Agent simulates user requests for access by sending user names and passwords to a RADIUS server, and recording the responses returned by the server. A Radius client agent is added to the `activityList` option of the `ixNetTraffic` object using the `appendItem` subcommand from the `ixConfigSequenceContainer` command. Other `ixConfigSequenceContainer` submay be used to modify the `activityList`.

### SUBCOMMANDS

The options for this command are configured and read using the standard `config`, `cget`, and `getOptions` subcommands defined in the `ixConfig` command.

### OPTIONS

`enable`

Enables the use of this client agent. (Default = true).

`name`

The name associated with this object, which must be set at object creation time.

### STATISTICS

### EXAMPLE

```
set Traffic1_Network1 [::IxLoad new ixNetTraffic]#-----
-----# Activity RADIUSClient1 of NetTraffic Traffic1@Network1#---
-----set Activity_RADIUSClient1
[$Traffic1_Network1 activityList.appendItem \-protocolAndType
"radius Client" ]$Activity_RADIUSClient1 agent.config \-enable
true \-name "RADIUSClient1"
```

### SEE ALSO

[ixNetTraffic](#)

## Radius Command List

Radius Command List—Creates the list of Radius commands that the client will send to a Radius server.

### SYNOPSIS

```
set Traffic1_Network1 [::IxLoad new ixNetTraffic]
set Activity_RADIUSClient1 [$Traffic1_Network1 activityList.appendItem options...]
$Activity_RADIUSClient1 agent.pm.cmdList.appendItem options...
```

### DESCRIPTION

A command is added to the Radius Command List object using the `appendItem` subcommand from the `ixConfigSequenceContainer` command (see the example).

### SUBCOMMANDS

The options for this command are configured and read using the standard `config`, `cget`, and `getOption` subcommands defined in the `ixConfig` command.

### OPTIONS

`id`

Radius command to be executed. One of the following:

Command	Description
ACCESS	Sends an ACCESS request to a RADIUS server. An ACCESS request is a query to determine whether a user should be allowed access to a specific NAS. The ACCESS request also can include a request for special services that the user may require.
ACCOUNTING	Sends an ACCOUNTING request to a RADIUS server. An ACCOUNTING request is a query for obtaining information that is used to provide accounting for a service provided to a user.
LoginWithAccountin	This is a combination of an ACCESS and ACCOUNTING comThis command simulates a scenario in which a user logs in to a NAS port and the NAS has accounting enabled for that user.



THINK	Causes the client to become idle. {Think} is an internal IxLoad command intended to assist your testing; it is not a command defined in the RADIUS protocol. If you specify identical values for the minimum and maximum times, the client will be idle for a fixed length of time. If you specify different values for the minimum and maximum times, IxLoad will select a value within the range and cause the client to be idle for that length of time.
LoopBeginCommand	An IxLoad command that you can add to the Command List to cause the commands between it and the {LoopEndCommand} to be executed a specified number of times.
LoopEndCommand	Ends the list of commands that will be executed by the preced{Loop Begin} command.

## Arguments for id = ACCESS

serverAddr

The IP address or symbolic destination (DUT configuration) of the RADIUS server to which the IxLoad client sends the ACCESS request packet. To specify a port, enter colon (:) then the port number after the IP address. For example: 192.168.100.1:1813. (Default = "198.18.0.100").

authenticationMethod

Method used to establish (and in the case of EAP-MD5, encrypt) the authenticacredentials of the simulated supplicants. Depending on the method you select, IxLoad enables and disables various Credentials fields.

The choices are:

Value	Description
PAP	(minimum) Password Authentication Protocol.
CHAP	Challenge Handshake Authentication Protocol. For CHAP the challenge that is normally generated by the authenticator/RAS is internally generated by IxLoad.
EAP-MD5	(default) Extensible Authentication Protocol, with MD5 encryption.
MS-CHAP	Microsoft CHAP, version 1
MS-CHAPv2	(maximum) Microsoft CHAP, version 2

userName

User name of the supplicant included in ACCESS request. maximum = 256.

password

Password for the supplicant. maximum = 128.

eapMD5Identity

If the authenticationMethod is EAP-MD5, this is the identity of the supplicant. maximum = 256.

attributeSetName

Attributes sent with the ACCESS request. See [AccessAttribSetList](#) on page 25-22. maximum = 256.

### Arguments for id = ACCOUNTING

serverAddr

The IP address or symbolic destination (DUT configuration) of the RADIUS server to which the IxLoad client sends the ACCOUNTING request packet. To specify a port, enter colon (:) then the port number after the IP address. For example: 192.168.100.1:1813. (Default = "198.18.0.100")

userName

User name included in ACCOUNTING request. maximum = 256

You can use sequence generators in this field to create a range of unique user names. See Appendix W, [Using Automatic Sequence Generators](#).

acctSessionId

Numeric identifier of the call for which the ACCOUNTING request is being sent. maximum = 256.

acctStatusType

Type of information that the ACCOUNTING request obtains. The values are:

Value	Description
1	Start (start time of call)
2	Stop (end time of call)
3	Interim-Update
7	Accounting-On
8	Accounting-Off
9-14	Reserved for Tunnel Accounting
15	Reserved for Failed

attributeSetName

Attributes sent with the ACCOUNTING request. See `AcctngAttribSetList` on page 25-23. maximum = 256.

## Arguments for `id = LoginWithAccountingEnabled`

serverAddr

The IP address or symbolic destination (DUT configuration) of the RADIUS server to which the IxLoad client sends the Accounting-Request packet. To specify port, enter colon (:) then the port number after the IP address. For example: 192.168.100.1:1813. (Default = "198.18.0.100")

authenticationPort

The UDP port on the RADIUS server to which the IxLoad client sends ACCESS requests. minimum = "1", maximum = "65535", default = "1812"

accountingPort

The UDP port on the RADIUS server to which the IxLoad client sends ACCOUNTING requests. minimum = "1" maximum = "65535" default= "1813"

authenticationMethod

Method used to establish (and in the case of EAP-MD5, encrypt) the authentic credentials of the simulated supplicants. Depending on the method you select, IxLoad enables and disables various Credentials fields.

The choices are:

Value	Description
PAP	(minimum) Password Authentication Protocol.
CHAP	Challenge Handshake Authentication Protocol. For CHAP the challenge that is normally generated by the authenticator/RAS is internally generated by IxLoad.
EAP-MD5	(default) Extensible Authentication Protocol, with MD5 encryption.
MS-CHAP	Microsoft CHAP, version 1
MS-CHAPv2	(maximum) Microsoft CHAP, version 2

userName

User name of the supplicant included in ACCESS request. maximum = 256.

You can insert sequence generators into this field to create unique entries autoFor information on how to use sequence generators, see [Using Automatic Sequence Generators on page A-1](#).

password

Password for the supplicant. maximum = 128.

You can insert sequence generators into this field to create unique entries autoFor information on how to use sequence generators, see [Using Automatic Sequence Generators on page A-1](#).

eapMD5Identity

If the `authenticationMethod` is EAP-MD5, this is the identity of the supplicant. maximum = 256

attributeSetName

Attributes sent with the ACCESS request. See [AccessAttribSetList on page 25-22](#).

learnFramedIp

After the client receives an ACCESS-ACCEPT, the first ACCOUNTING-START request that it sends may include the attribute Framed-IP, and a value for it. This parameter determines the source of the value for the Framed-IP attribute. If this option is enabled:

- If the ACCESS-ACCEPT contains a Framed-IP attribute and a value, the cliuses the value from the ACCESS-ACCEPT.
- If the attribute set includes a Framed-IP attribute and value, the client ignores the value in the attribute set and uses the value from the ACCESS-ACCEPT. •If the ACCESS-ACCEPT does not contain a Framed-IP attribute but the attribute set does, the client uses the value from the attribute set.
- If neither the ACCESS-ACCEPT nor the attribute set contains a Framed-IP attribute, then this option is ignored and the ACCOUNTING-START does not contain a Framed-IP attribute.

Default = false.

### Arguments for id = THINK

minimumInterval

Minimum length of time that the user will remain inactive for. Minimum = "1," maximum = "2,147,483,647." (Default = "1").

maximumInterval

Maximum length of time that the user will remain inactive for. Minimum = "1," maximum = "2,147,483,647." (Default = "1").

### Arguments for id = LoopBeginCommand

loopCount

---

Number of times to repeat the enclosed commands. '0' treated as infinity. Mini= "0," maximum = "2,147,483,647." (Default = "5").

### Arguments for id = LoopEndCommand

None.

#### EXAMPLE

```
$Activity_RADIUSClient1 agent.pm.cmdList.appendItem \  
-id "ACCESS" \  
-userName "ixia" \  
-authenticationMethod 0 \  
-attributeSetName "ACCESS-REQUEST-Attribute-Set-1" \  
-eapMD5Identity "" \  
-serverAddr "198.18.0.100" \  
-password "ixia"
```

#### SEE ALSO

[Radius Client Agent](#)

## Global Config

Global Config—Configures the parameters that define the way the IxLoad RADIUS client performs overall.

### SYNOPSIS

```
set Traffic1_Network1 [::IxLoad new ixNetTraffic]
set Activity_RADIUSClient1 [$Traffic1_Network1 activityList.appendItem options...]
$Activity_RADIUSClient1 agent.pm.globalConfig.config options...
```

### DESCRIPTION

To configure the Global Config options, use the `appendItem` command on the `pm.optionSetManager` component of the `Radius Client Agent`. Note the use of the `'pm.'` component. See the following example:

```
$Activity_RADIUSClient1 agent.pm.globalConfig.config
```

### SUBCOMMANDS

None.

### OPTIONS

`defaultAuthenticationPort`

The UDP port on the RADIUS server to which the IxLoad client sends Access-Requests. `minimum = "1"`, `maximum = "65535"`, `default = "1812"`.

`defaultAccountingPort`

The UDP port on the RADIUS server to which the IxLoad client sends Accountminimum = "1", maximum = "65535", default = "1813".

`authenticationRetryCount`

Number of times the IxLoad RADIUS client will re-send an unacknowledged Access-Request.

If the RADIUS server does not respond to an Access-Request within the Response Timeout period, the client resends the Access-Request. `minimum = "0"`, `maximum = "65535"`, `default = "3"`.

`responseTimeouot`

Elapsed time, in seconds, allowed for the server to respond to a client request. `minimum = "1"`, `maximum = "65535"`, `default = "5"`.

`defaultSharedSecret`

Secret used if no server-specific secret is configured. See `Specific Secrets` on page 25-18. `minimum = "1"`, `maximum = "256"`, `default = "ixia"`.

`send_ACCOUNTING_REQUESTS_when_ACCESS_REQUEST_are_pending`

If enabled (1), the IxLoad client requests accountdata even if requests for authentication (Access-Requests) are still pending. If disabled (0), the IxLoad client does not send accounting data if any Access-Requests are pending. Default = "1".

maxPendingRequestPerClient

Maximum number of pending requests per client that the IxLoad client maintains with the RADIUS server. minimum = "1", maximum = "64000", default = "100".

#### EXAMPLE

```
$Activity_RADIUSClient1 agent.pm.globalConfig.config \-defaultAccountingPort
1813 \-defaultAuthenticationPort 1812 \-defaultSharedSecret
"ixia" \-authenticationRetryCount 3 \-accountingRetryCount
3 \-responseTimeout 5 \-send_ACCOUNTING_REQUESTS_when_
ACCESS_REQUESTS_are_pending true \-maxConcurrentSessions 100 \-
implicitLoopCheck true
```

#### SEE ALSO

[Radius Client Agent](#)

## Specific Secrets

Specific Secrets—Configures secrets to be used with specific servers.

### SYNOPSIS

```
set Traffic1_Network1 [::IxLoad new ixNetTraffic]
set Activity_RADIUSClient1 [$Traffic1_Network1 activityList.appendItem options...]
$Activity_RADIUSClient1 agent.pm.specificSecrets.config options...
```

### DESCRIPTION

To configure Specific Secrets, use the `appendItem` command on the `pm.option` component of the Radius Client Agent. Note the use of the `'pm.'` component.

### SUBCOMMANDS

None.

### OPTIONS

`sharedSecretList`

The list of shared secrets to be used with specific servers.

`clientIdRange`

This corresponds to the IP addresses configured in the network portion of the RADIUS client's NetTraffic. `maximum = 256`.

`serverIp`

IP address of the server to which the secret applies. `minimum = "7"` `maximum = "19"` `default = "198.18.0.100"`.

`sharedSecret`

The shared secret is entered in this field. `minimum = "1"` `maximum = "256"` `default = "ixia"`.

### EXAMPLE

```
$Activity_RADIUSClient1 agent.pm.specificSecrets.sharedSecretList.appendItem \
-id "ClientServerSecrets" \
-clientIdRange "1-5" \
-secretListString ("\"198.18.0.101\"", \"ixia\"), (\"198.18.0.102\"", \"ixia\")"
$Activity_RADIUSClient1 agent.pm.specificSecrets.sharedSecretList(0).server-
SecretList.appendItem -id "ServerSecrets" \-
serverIP "198.18.0.101" \-sharedSecret
"ixia"
```



**SEE ALSO**

[Radius Client Agent](#)

## Vendor List

Vendor List—contains the predefined vendors and their vendor-codes that the IxLoad client uses.

### SYNOPSIS

```
set Traffic1_Network1 [::IxLoad new ixNetTraffic]
set Activity_RADIUSClient1 [$Traffic1_Network1 activityList.appendItem options...]
$Activity_RADIUSClient1 agent.pm.vendorList.v_list.appendItem \ options...
```

### DESCRIPTION

To configure a Vendor List, use the `appendItem` command on the `pm.optionSetComponent` of the Radius Client Agent. Note the use of the `'pm.'` com

### SUBCOMMANDS

None.

### OPTIONS

vendorName

Name of the vendor. maximum = 256

vendorId

This is the vendor code. maximum = 8

### EXAMPLE

```
$Activity_RADIUSClient1 agent.pm.vendorList.v_list.appendItem \-id
"Vendor" \-vendorId "NA" \
-vendorName "IETF RADIUS STANDARD" \
-isPredefined true
```

### SEE ALSO

[Radius Client Agent](#)

## Attribute List

Attribute List—contains the predefined Attributes, their values, and the vendors that originally specified them.

### SYNOPSIS

```
set Traffic1_Network1 [::IxLoad new ixNetTraffic]
set Activity_RADIUSClient1 [$Traffic1_Network1 activityList.appendItem options...]
$Activity_RADIUSClient1 agent.pm.attributeList.a_list.appendItem \ options...
```

### DESCRIPTION

To configure an Attribute List, use the `appendItem` command on the `agent.pm` component of the Radius Client Agent. Note the use of the `'pm.'` component.

### SUBCOMMANDS

None.

### OPTIONS

`attributeName`

Name of the attribute. maximum = "256"

`attributeCode`

The attribute code. minimum = "0" maximum = "255"

`vendorName`

Name of the vendor. maximum = "256"

`vendorId`

This represents the vendor id. maximum = "8"

`valueType`

This represents the data type of the attribute value. minimum = "0", maximum = "7"

The choices are:

Value	Description
0	Integer (1 octet)
1	Integer (2 octets)
2	Integer (3 octets)

3	Integer (4 octets)
4	String
5	IPv4 Address
6	MTU
7	Hexadecimal

relevance

This represents the request type with which the attribute can be used. minimum = "0" maximum = "2"

The choices are:

Value	Description
0	Both Authentication And Accounting
1	Authentication Only
2	Accounting Only

### EXAMPLE

```
$Activity_RADIUSClient1 agent.pm.attributeList.a_list.appendItem \-id  
"Attribute" \-attributeCode 40 \-attributeName  
"Acct-Status-Type" \-valueType 3 \-relevance  
2 \-vendorName "IETF RADIUS STANDARD" \-isPredefined  
true
```

### SEE ALSO

[Radius Client Agent](#)

---

## AccessAttribSetList

AccessAttribSetList—Configures the list of Access Attribute Sets.

### SYNOPSIS

```
set Traffic1_Network1 [::IxLoad new ixNetTraffic]
set Activity_RADIUSClient1 [$Traffic1_Network1 activityList.appendItem options...]
Activity_RADIUSClient1 agent.pm.accessAttribSetList.accessAttribVal\ options...
```

### DESCRIPTION

To configure an AccessAttribSetList, use the `appendItem` command on the `agent.pm` component of the Radius Client Agent. Note the use of the `'pm.'` com

### SUBCOMMANDS

None.

### OPTIONS

`attributeValueSetName`

This represents the name of the ACCESS attribute set.

`refCount`

The numerical order of the attribute set.

### EXAMPLE

```
$Activity_RADIUSClient1 agent.p-
m.accessAttribSetList.accessAttributeValueSetList.appendItem \
-id "AttributeValueSet" \
-attributeValueSetName "ACCESS-REQUEST-Attribute-Set-1" \
-refCount 1
```

### SEE ALSO

[Radius Client Agent](#)

## AcctngAttribSetList

Accounting Attribute Set List—Configures the list of Accounting Attribute Sets.

### SYNOPSIS

```
set Traffic1_Network1 [::IxLoad new ixNetTraffic]
set Activity_RADIUSClient1 [$Traffic1_Network1 activityList.appendItem options...]
$Activity_RADIUSClient1 agent.p-
m.acctngAttribSetList.acctngAttribValueSetList.appendItem \ options...
```

### DESCRIPTION

To configure an Accounting Attribute Set List, use the `appendItem` command on the `agent.pm` component of the `Radius Client Agent`. Note the use of the `'pm.'` component.

### SUBCOMMANDS

None.

### OPTIONS

`attributeValueSetName`

This represents the name of the ACCOUNTING attribute set.

`refCount`

The numerical order of the attribute set.

### EXAMPLE

```
$Activity_RADIUSClient1 agent.p-
m.acctngAttribSetList.acctngAttribValueSetList.appendItem \
-id "AttributeValueSet" \
-attributeValueSetName "ACCOUNTING-REQUEST-Attribute-Set-1" \
-refCount 1
```

### SEE ALSO

[Radius Client Agent](#)

## RADIUS Client Statistics

The table below describes the RADIUS client statistics.

The QoE Detective column indicates the views in which a statistic is available:

**IP:** per-IP view

**User:** per-User view

**VLAN:** per-VLAN view

**All:** all views

Statistic	QoE Detective	Description
<b>Test Objective Related Statistics</b>		
RADIUS Simulated Users	- -	Number of RADIUS clients (NAS, RAS, or other RADIUS-enabled devices) simulated by the IxLoad RADIUS client.
RADIUS Transaction Rate	All	Average rate at which the client completed RADIUS transactions.
RADIUS Total Transactions	All	Total number of RADIUS transactions completed.
RADIUS Sessions Alive	All	Total number of RADIUS sessions online.
RADIUS Logged In Supplicants	All	Total number of simulated supplicants authenticated by the IxLoad RADIUS client.
<b>Authentication Statistics</b>		
RADIUS Authentications Attempted	All	Number of authentications attempted using RADIUS.
RADIUS Authentications Succeeded	All	Number of authentications that succeeded.
RADIUS Authentications Failed	All	Number of authentications that failed.
<b>Access-Request and -Response Statistics</b>		
RADIUS Total Access Requests Sent	All	Number of Access-Request packets sent by the client.
RADIUS Total Access Accept Received	All	Number of Access-Accept packets received by the client.

RADIUS Total Access Reject Received	All	Number of Access-Reject packets received by the client.
RADIUS Total Access Challenge Received	All	Number of Access-Challenge packets received by the client.
RADIUS Total Access Request Timeouts	All	Number of Access-Request packets sent for which no response was received within the timeout period.
RADIUS Total Invalid Replies To Access Requests	All	Number of invalid responses to Access-Request packets received by the client.
RADIUS Total Access Request Errors	All	Total number of errors that occurred either while sending an Access Request or afterwards. This statistic mainly counts socket-level errors and does not include timeouts and invalid responses, which are counted by other statistics.
RADIUS Total Access Request Aborted	All	Number of Access-Requests that were aborted.
<b>Successful Authentications Statistics</b>		
RADIUS Total Authentications Succeeded Using PAP	All	Number of successful PAP authentications.
RADIUS Total Authentications Succeeded Using CHAP-MD5	All	Number of successful CHAP-MD5 authentications.
RADIUS Total Authentications Succeeded Using EAP-MD5	All	Number of successful EAP-MD5 authentications.
RADIUS Total Authentications Succeeded Using MS-CHAPv1	All	Number of successful MS-CHAPv1 authentications.
RADIUS Total Authentications Succeeded Using MS-CHAPv2	All	Number of successful MS-CHAPv2 authentications.
<b>Failed Authentications Statistics</b>		
RADIUS Total Authentications Failed Using PAP	All	Number of failed PAP authentications.
RADIUS Total Authentications Failed Using CHAPMD5	All	Number of failed CHAP-MD5 authentications.



RADIUS Total Authentications Failed Using EAPMD5	All	Number of failed EAP-MD5 authentications.
RADIUS Total Authentications Failed Using MSCHAPv1	All	Number of failed MS-CHAPv1 authentications.
RADIUS Total Authentications Failed Using MSCHAPv2	All	Number of failed MS-CHAPv2 authentications.
<b>Accounting Requests Statistics</b>		
RADIUS Total Accounting Requests Sent	All	Total number of Accounting-Request packets sent by the client.
RADIUS Total Accounting Start Requests Sent	All	Number of Accounting-Request-Start packets sent by the client.
RADIUS Total Accounting Stop Requests Sent	All	Number of Accounting-Request-Stop packets sent by the client.
RADIUS Total Accounting Responses Received	All	Number of Accounting-Response packets received by the client.
RADIUS Total Timeouts for Accounting Requests	All	Total number of Accounting-Request packets for which no response was received within the timeout period.
RADIUS Total Timeouts for Accounting Start Requests	All	Number of Accounting-Request-Start packets for which no response was received within the timeout period.
RADIUS Total Timeouts for Accounting Stop Requests	All	Number of Accounting-Request-Stop packets for which no response was received within the timeout period.
RADIUS Total Invalid Replies To Accounting Requests	All	Total number of invalid replies to Accounting-Request packets received by the client.
RADIUS Total Accounting Request Errors	All	Total number of timeouts and invalid responses to Accounting-Request packets.
RADIUS Total Accounting Request Aborted	All	Total number of Accounting-Requests that were aborted.
<b>Request / Response Statistics</b>		

RADIUS Total Requests Sent	All	Total number of Access-Requests and Accounting-Requests sent by the client.
RADIUS Total Responses Received	All	Total number of responses to Access-Requests and Accounting-Requests received by the client.
RADIUS Total Responses To Accounting Stop	All	Total number of responses to Accounting-Request-Stop packets received by the client.
<b>Request / Response Rate Statistics</b>		
RADIUS Requests Sent Per Second	All	Rate at which the client sent Access-Request or Accounting-Request packets.
RADIUS Responses Received Per Second	All	Rate at which the client received responses to Access-Request or Accounting-Request packets.
RADIUS Access Requests Sent Per Second	All	Rate at which the client sent Access-Request packets.
RADIUS Total Accounting Requests Sent Per Second	All	Rate at which the client sent Accounting-Request packets.
RADIUS Total Accounting Start Requests Sent Per Second	All	Rate at which the client sent Accounting-Request-Start packets.
RADIUS Total Accounting Stop Requests Sent Per Second	All	Rate at which the client sent Accounting-Request-Stop packets.
RADIUS Total Session Tear-downs	All	Number of RADIUS sessions torn down.
RADIUS Session Teardown Rate	All	Rate at which the client tore down RADIUS sessions.
<b>Throughput Statistics</b>		
RADIUS Total Bytes Sent	All	Total number of RADIUS bytes (headers+payload) sent.
RADIUS Total Bytes Received	All	Total number of RADIUS bytes (headers+payload) received.
RADIUS Total Bytes Sent and Received	All	Combined total of RADIUS bytes (headers+payload) sent and received.
RADIUS UDP Packets Sent	All	Number of UDP packets sent with RADIUS payloads.

RADIUS UDP Packets Received	All	Number of UDP packets received with RADIUS payloads.
RADIUS Bytes Sent per sec	All	Rate at which the client sent RADIUS data, in bytes per second.
RADIUS Bytes Received per sec	All	Rate at which the client received RADIUS data, in bytes per second.
RADIUS UDP Packets Sent per sec	All	Rate at which the client sent UDP packets with RADIUS payloads, in bytes per second.
RADIUS UDP Packets Received per sec	All	Rate at which the client received UDP packets with RADIUS payloads, in bytes per second.
<b>Retransmission Statistics</b>		
RADIUS Total Retransmissions For Access Requests	All	Total number of Access-Requests that had to be retransmitted.
RADIUS Total Retransmissions For Accounting Requests	All	Total number of Accounting-Requests that had to be retransmitted.
RADIUS Total Retransmissions For Accounting Start Requests	All	Total number of Accounting-Request-Start packets that had to be retransmitted.
RADIUS Total Retransmissions For Accounting Stop Requests	All	Total number of Accounting-Request-Stop packets that had to be retransmitted.
<b>Response Time Statistics</b>		
RADIUS Average Time To Receive Access Response	All	Average time elapsed between the time the client sent an Access-Request and the time it received any type of response. Note for Tcl API users: This is a weighted statistic. If you are using this statistic in a Tcl script, use the <i>kWeightedAverage</i> aggregation type.
RADIUS Average Time To Receive Access Accept Response	All	Average time elapsed between the time the client sent an Access-Request and the time it received an Access-Accept in response. Note for Tcl API users: This is a weighted statistic. If you are using this statistic in a Tcl script, use the <i>kWeightedAverage</i> aggregation type.

RADIUS Average Time To Receive Access Reject Response	All	Average time elapsed between the time the client sent an Access-Request and the time it received an Access-Reject in response. Note for Tcl API users: This is a weighted statistic. If you are using this statistic in a Tcl script, use the <i>kWeightedAverage</i> aggregation type.
RADIUS Average Time To Receive Accounting Response	All	Average time elapsed between the time the client sent an Accounting-Request and the time it received an Accounting-Response. Note for Tcl API users: This is a weighted statistic. If you are using this statistic in a Tcl script, use the <i>kWeightedAverage</i> aggregation type.
<b>Access Accept Latency statistics</b>		
RADIUS Total Access Accept Responses With Latency Between 0 to 2 millise	--	Number of Access Accept responses received with latencies between 0 and 2 milliseconds.
RADIUS Total Access Accept Responses With Latency Between 2 to 5 millise	--	Number of Access Accept responses received with latencies between 2 and 5 milliseconds.
RADIUS Total Access Accept Responses With Latency Between 5 to 10 millise	--	Number of Access Accept responses received with latencies between 5 and 10 milliseconds.
RADIUS Total Access Accept Responses With Latency Between 10 to 50 millise	--	Number of Access Accept responses received with latencies between 10 and 50 milliseconds.
RADIUS Total Access Accept Responses With Latency Between 50 to 100 millise	--	Number of Access Accept responses received with latencies between 50 and 100 milliseconds.
RADIUS Total Access Accept Responses With Latency Between 100 to 500 millise	--	Number of Access Accept responses received with latencies between 100 and 500 milliseconds.
RADIUS Total Access Accept Response With Latency Greater Than 500 millise	--	Number of Access Accept responses received with latencies over 500 milliseconds.
<b>Access Reject Latency statistics</b>		

RADIUS Total Access Reject Responses With Latency Between 0 to 2 millise	- -	Number of Access Reject responses received with latencies between 0 and 2 milliseconds.
RADIUS Total Access Reject Responses With Latency Between 2 to 5 millise	- -	Number of Access Reject responses received with latencies between 2 and 5 milliseconds.
RADIUS Total Access Reject Responses With Latency Between 5 to 10 millise	- -	Number of Access Reject responses received with latencies between 5 and 10 milliseconds.
RADIUS Total Access Reject Responses With Latency Between 10 to 50 millise	- -	Number of Access Reject responses received with latencies between 10 and 50 milliseconds.
RADIUS Total Access Reject Responses With Latency Between 50 to 100 millise	- -	Number of Access Reject responses received with latencies between 50 and 100 milliseconds.
RADIUS Total Access Reject Responses With Latency Between 100 to 500 millise	- -	Number of Access Reject responses received with latencies between 100 and 500 milliseconds.
RADIUS Total Access Reject Response With Latency Greater Than 500 millise	- -	Number of Access Reject responses received with latencies over 500 milliseconds.
Accounting Response Latency statistics		
RADIUS Total Accounting Responses With Latency Between 0 to 2 millise	- -	Number of Access Response responses received with latencies between 0 and 2 milliseconds.
RADIUS Total Accounting Responses With Latency Between 2 to 5 millise	- -	Number of Access Response responses received with latencies between 2 and 5 milliseconds.
RADIUS Total Accounting Responses With Latency Between 5 to 10 millise	- -	Number of Access Response responses received with latencies between 5 and 10 milliseconds.
RADIUS Total Accounting Responses With Latency Between 10 to 50 millise	- -	Number of Access Response responses received with latencies between 10 and 50 milliseconds.

RADIUS Total Accounting Responses With Latency Between 50 to 100 millisecc	- -	Number of Access Response responses received with latencies between 50 and 100 milliseconds.
RADIUS Total Accounting Responses With Latency Between 100 to 500 millisecc	- -	Number of Access Response responses received with latencies between 100 and 500 milliseconds.
RADIUS Total Accounting Response With Latency Greater Than 500 millisecc	- -	Number of Access Response responses received with latencies over 500 milliseconds.

! 27

# RTSP

This section describes the RTSP Tcl API objects.

## Overview

RTSP protocol commands are organized as:

- RTSP Client Agent
- RtspCommand
- RtspHeaders
- RtspHeader
- RTSP Server Agent
- PresentationItem
- Content
- Stream

## Objectives

The objectives (userObjective) you can set for RTSP are listed below. Test objecare set in the ixTimeline object.

- connectionRate
- transactionRate
- simulatedUsers
- concurrentConnections

## RTSP Client Agent

The RTSP Client Agent defines a simulated user performing RTSP requests against one or more RTSP servers. Refer to `RTSP Client Agent` for a full descripf of this command. The important options of this command are listed below.

Option	Usage
enable	Enables the use of the RTSP client agent.
name	The name associated with the client agent.
rtspTransport	The RTSP transport mechanism that the client will request.
commandList	A list of RTSP commands that the client will transmit, with arguments. Each list element is of type <code>RtspCommand</code> .
rtspHeaders	A list of RTSP headers that the client will transmit with each command. Each list element is of type <code>RtspHeaders</code> .
commandTimeout	The client command timeout.

## RtspCommand

Each client command is a single step in the interaction. Refer to `RtspCommand` for a full description of this command. The important options of this command are listed below.

Option	Usage
command arguments	The RTSP command, with optional arguments, to be executed.
destination	The name/address of the RTSP server.
media	The URL of the media object to be controlled.

## RtspHeaders

The `RtspHeaders` command specifies a client emulation and includes a list of `name=value` header pairs. Refer to `RtspHeaders` for a full description of this command. The important options of this command are listed below.



Option	Usage
clientEmulation	Indicates the type of RTSP client to emulate.
list	A list of individual RTSP headers. Each list item is of type <code>RtspHeader</code> .

## RtspHeader

Each `RtspHeader` item represents a single `name=value` header pair. Refer to `RtspHeader` for a full description of this command. The important options of this command are listed below.

Option	Usage
name	The <code>name</code> part of the pair.
value	The <code>value</code> part of the pair.

## RTSP Server Agent

The RTSP Server Agent defines the operation of the RTSP server. Refer to `RTSP Server Agent` for a full description of this command. The important options of this command are listed below.

Option	Usage
enable	Enables the use of the server agent.
name	The name associated with the server agent.
port	The port number that the server will respond on.
serverEmulation	The type of RTSP server that the server agent will emulate.
presentationList	The set of media presentations that the server will respond for. Each item is of type <code>PresentationItem</code> .

contentList	A list of contents that are used in the <code>presentationList</code> . Each item is of type <code>Content</code> .
commandTimeout	Response timeout value.

## PresentationItem

The `PresentationItem` is a specification of a media presentation offered by the server. Refer to `PresentationItem` for a full description of this command. The important options of this command are listed below.

Option	Usage
path	The URL of the media file.
content	The name of an item in the RTSP Server Agent's <code>contentList</code> .
duration	The length of the media presentation.

## Content

The `Content` object is a named set of media streams. Refer to `Content` for a full description of this command. The important options of this command are listed below.

Option	Usage
name	The name of the content.
streamList	A list of streams that compose the content. Each list item is of type <code>Stream</code> .

## Stream

The `Stream` object is a single media stream object. Refer to `Stream` for a full description of this command. The important options of this command are listed below.

Option	Usage
name	The name of the stream.
clockRate	The sampling rate.
dataRate	The data transmission rate.
packetization	The time between packets.

## RTSP Client Agent

RTSP Client Agent - create an RTSP client

### SYNOPSIS

```
set Traffic1_Network1 [::IxLoad new ixNetTraffic]
set Activity_RTSPClient1 [$Traffic1_Network1 activityList.appendItem
$Activity_RTSPClient1 agent.config options...
```

### DESCRIPTION

An RTSP client agent is added to the `activityList` object. The `activityList` object is added to the `ixNetTraffic` object using the `appendItem` subcommand from the `ixConfigSequenceContainer` command.

Each member of the list, however may be separately addressed and modified using the `ixConfig` subcommands.

### SUBCOMMANDS

The options for this command are configured and read using the standard `config`, `cget`, and `getOption` subcommands defined in the `ixConfig` command.

### OPTIONS

`commandList`

This is a list of type `RtspCommand` used to hold RTSP commands. The elements in this list describe the commands to be executed by the client. (Default = {}).

`commandTimeout`

The amount of time allowed for each command to complete, in seconds. (Default = 60).

`enable`

If `true`, this agent will be used. (Default = `true`).

`enableEsm`

If `true`, the use of the `esm` option is enabled. (Default = `false`).

`enableTos`

Enables the setting of the TOS (Type of Service) bits in the header of the RTSP packets. Use the `tos` option to specify the TOS bit setting.

0	(default) TOS bits not enabled.
1	TOS bits enabled.

esm

If `enableEsm` is `true`, this option specifies the TCP Maximum Segment Size in the MSS (RX) field. Otherwise, the TCP Maximum Segment Size as 1,460 bytes. (Default = 1,460).

`enableVlanPriority`

VLAN Priority can be set on a per-activity basis or on a per-network (NetTraffic) basis. This parameter sets the VLAN priority for the activity. An activity's VLAN Priority bit setting takes precedence over a network's Priority bit setting. If `true`, IxLoad sets the VLAN Priority bit in traffic from this activity. Configure the VLAN priority value in `vlanPriority`. (Default = false).

`vlanPriority`

When `enableVlanPriority` is `true`, this option accepts the `vlan` priority value.

`name`

The name associated with this object, which must be set at object creation time.

`rtpTransport`

The RTSP mechanism to be requested by the client. One of:

Option	Usage
<code>\$.:RTSP_Client(kRtpTransportTcp)</code>	TCP.
<code>\$.:RTSP_Client(kRtpTransportUdp)</code>	(Default) UDP.

`tos`

If `enableTos` is `true`, this option specifies the IP Precedence / TOS (Type of Service setting and Assured Forwarding classes. (Default="0"). The choices are:

0	(Default) (0x000) routine
32	(0x0020) priority service, Assured Forwarding class 1
64	(0x0040) immediate service, Assured Forwarding class 2
96	(0x0060) flash, Assured Forwarding class 3
128	(0x0080) flash-override, Assured Forwarding class 4
160	(0x00A0) critical-ecp
192	(0x00C0) internet-control

`enableCustomSETUPtransportParam`

This enables or disables the entry of parameters specified in the Transport: line of the RTSP SETUP message. You can use these parameters to set or enable addiRTSP transport options on the server. Default = false.

`customSETUPtransportParam`

If `enableCustomSETUPtransportParam` is false, then the Transport: line contains the following data, which is mandatory for RTSP:

Transport protocol, connection type (unicast or multicast), and client IP port range used for the transport protocol. For example:

```
RTP/AVP;unicast;client_port=35246-35247
```

If `enableCustomSETUPtransportParam` is true, then IxLoad appends a semi-colon (;) to the mandatory data on Transport: line, and then appends the custom data in the field.

For example, if you specify the string `mode=PLAY`, the Transport: line will contain the following string:

```
RTP/AVP;unicast;client_port=35246-35247;mode=PLAY
```

`enableSETUPargs`

If enabled, you can specify the IP address, Media and arguments (which compose the presentation to setup (such as "audio" or "audio, video") for the SETUP command.

Normally, these parameters are specified in the DESCRIBE command. However, some servers do not support the DESCRIBE command.

If no arguments are specified, IxLoad sets up the URL.

`followRtspRedirects`

If enabled, the client follows RTSP redirect responses from the server.

`useSameRtpPort`

If enabled, all RTP streams for one presentation use the same UDP port number.

RTP audio and video streams are usually sent over different UDP ports. However, some Windows RTP servers send both streams over the same port. If this is the case with your server, enable this option.

`enableRtspProxy`

If enabled, you can enter the Rtsp proxy server address.

`rtspProxy`

If `enableRtspProxy` is true, then you can enter the Rtsp proxy ip and port address.

## SUB-OBJECTS

`rtspHeaders`

This is an object of type `RtspHeaders`, which holds information about the type of client emulation desired as well as a list of RTSP headers to be supplied by the client for each request. (Default = default object of type `RtspHeaders`).

## STATISTICS

### EXAMPLE

```
set Traffic1_Network1 [::IxLoad new ixNetTraffic]

##### Activity RTSPClient1 of
NetTraffic Traffic1@Network1#####set
Activity_RTSPClient1 [$Traffic1_Network1 activityList.appendItem \-protocolAndType
"RTSP Client" ]

##### Timeline1 for activities RTSPCli-
ent1#####set Timeline1 [::IxLoad new
ixTimeline]$Timeline1 config \-rampUpValue          1 \-
rampUpType          0 \-offlineTime
0 \-rampDownTime    20 \-standbyTime
0 \-iterations      1 \-rampUpInterval
1 \-sustainTime     20 \-timelineType
0 \-name             "Timeline1"$Activity_RTSPClient1 config
\-enable            1 \-name
"RTSPClient1" \-enableConstraint          false \-userObjectiveValue
100 \-constraintValue          100 \-userObjectiveType
"simulatedUsers" \-timeline             $Timeline1set my_RtspHead-
ers [::IxLoad new RtspHeaders]$my_RtspHeaders config \-clientEmulation
1$my_RtspHeaders list.clearset User_Agent [::IxLoad new RtspHeader]$User_Agent con-
fig \-name             "User-Agent" \-value
"QTS (qtver=6.5)"$my_RtspHeaders list.appendItem -object $User_Agent$Activity_
RTSPClient1 agent.config \-enableTos          0 \-loopValue
true \-commandTimeout          60 \-enable
1 \-name             "RTSPClient1" \-
setEnableCustomSETUPtransportParam      true \-tos
0 \-vlanPriority      0 \-customSETUPtransportParam
"mode=PLAY" \-followRtspRedirects        0 \-enableRtspProxy
0 \-enableSETUPargs  true \-rtpTransport
3 \-enableEsm        0 \-rtspProxy
"0.0.0.0:554" \-useSameRtpPort            0 \-esm
1460 \-enableVlanPriority          0 \-enableCustomSETUPtransportParam
true \-rtspHeaders              $my_RtspHeaders$Activity_RTSPClient1
agent.urlList.clear$Activity_RTSPClient1 agent.setParamOptionList.clear$Activity_
RTSPClient1 agent.commandList.clearset my_RtspCommand [::IxLoad new RtspCommand]$my_
RtspCommand config \-media              "/test1.mp3" \-
```

```
destination                                "Traffic2_RTSPServer1" \-command
"{PlayMedia}" \-arguments                  "PLAY_TILL_END"$Activity_
RTSPClient1 agent.commandList.appendItem -object $my_RtspCommand$Activity_RTSPCli-
ent1 agent.getParamOptionList.clear
```

### **SEE ALSO**

[ixNetTraffic](#)

[RtspCommand](#)

[RtspHeaders](#)



## RtspCommand

RTSP Command — Specifies an RSTP command to be executed.

### SYNOPSIS

```
set Traffic1_Network1 [::IxLoad new ixNetTraffic]
set Activity_RTSPClient1 [$Traffic1_Network1 activityList.appendItem
set my_RtspCommand [::IxLoad new RtspCommand]
$Activity_RTSPClient1 agent.commandList.appendItem -object $my_RtspCommand
```

### DESCRIPTION

An RTSP command is added to the `commandList` option of the `RTSP Client Agent` object using the `appendItem` subcommand from the `ixConfigSequenceContainer` command.

Each member of the list, however may be separately addressed and modified using the `ixConfig` subcommands.

### SUBCOMMANDS

The options for this command are configured and read using the standard `config`, `cget`, and `getOption` subcommands defined in the `ixConfig` command.

### OPTIONS

arguments

This option contains an argument that is used by the various commands defined in `command`. The type of the value depends on the command:

command option	Usage
"{PlayMedia}"	N/A.
"DESCRIBE"	N/A.
"SETUP"	The transport mechanism to be used. One of: "TCP" or "UDP."
"SET_PARAMETER"	Takes only one string value. This string argument appear as <code>name</code> in one of the entries of <code>setParamOptionList</code> .
"GET_PARAMETER"	
"PLAY"	The playback duration, in seconds.
"{KeepAlive}"	Keeps the client and server connection alive

"PAUSE"	N/A.
"{Think}"	The length of time to pause, in seconds.
"TEARDOWN"	N/A.

command

Selects the RTSP command to be used. One of:

Option	Usage
"{PlayMedia}"	(Default) An IxLoad command that plays the file listed in the <code>media</code> option. This command sets up the RTSP control connection, requests the URL from the server, then tears down the RTSP connection.
"DESCRIBE"	Retrieves the description of a presentation or media object identified by the URL in the <code>media</code> option. The server responds with a description of the requested resource.
"{KeepAlive}"	Periodically sends a short message (and empty GET_PARAMETER command) to the server so that the server does not assume that the client is inactive and then tears down the connection. Although you can add a {KeepAlive} to any position in a command list, it should typically be placed after a PLAY command.
"SETUP"	Specifies the transport mechanism to be used for the streamed media. A client can issue a SETUP request for a stream that is already playing to change transport parameters, if the server allows it. Specify the transport mechanism in the <code>arguments</code> option.
"SET_PARAMETER"	This method requests to set the value of a parameter for a presentation or stream specified by the URL. Specify the name of this parameter in the <code>arguments</code> option.
"PLAY"	Tells the server to start playback using the mechanism specified by a previous SETUP command. Specify the stream in the <code>media</code> option, and the playback duration in the <code>arguments</code> option.
"PAUSE"	Causes the stream playback to be temporarily halted. If you specify a stream in the <code>media</code> option, only playback of that stream is halted. If you do not specify a stream, all streams are <b>paused</b> .
"GET_PARAMETER"	Retrieves the current value of a parameter from the server. If you issue the GET_PARAMETER with no arguments, it functions as a keep-alive to prevent the server from closing the connection when long presentations are playing. The IxLoad RTSP client does not process responses to GET_PARAMETER commands.

"{Think}"	An IxLoad command that pauses execution of the command list. Specify the length of time to pause, in seconds, in the <code>arguments</code> option.
"TEARDOWN"	Stops the stream delivery for the URL listed in the <code>media</code> option, freeing the resources associated with it. After issuing the <code>TEAR</code> command, the RTSP session identifier associated with the session is no longer valid.
"{LoopBegin}"	An IxLoad command that you can add to the Command List to cause the commands between it and the <code>{Loop End}</code> to be executed a specified number of times.
"{LoopEnd}"	Ends the list of commands that will be executed by the preceding <code>{Loop Begin}</code> command.

`destination`

The RTSP server that the client will send the media URL described in `media` to. The media URL identifies the set of stream to be controlled. Specify the destination as follows:

- If the destination is a real RTSP server, specify the server's host name or IP address.
- If the destination is an IxLoad RTSP Server Agent, specify the name of the RTSP Server Agent.
- If the destination is the DUT, specify `DUT:n`—where `DUT` is the name of the DUT and `n` is the port number on that DUT.

(Default = "None").

`media`

The presentation URL sent to the server. The presentation URL identifies the stream to be controlled. Media names may only contain letters, numbers, and the special symbols `\:', \;', \_', \/'` and `\'.`

(Default = "None").

In an RTSP test, you can use sequence generators in the `media` field of the following RTSP client commands:

```
DESCRIBE{Playmedia}
```

### EXAMPLE

```
set my_RtspCommand [::IxLoad new RtspCommand]$my_RtspCommand config \-media
"/test1.mp3" \-destination "Traffic2_RTSPServer1" \-
command "{PlayMedia}" \-arguments
"PLAY_TILL_END"$Activity_RTSPClient1 agent.commandList.appendItem -object $my_
RtspCommand
```

### SEE ALSO

[RTSP Client Agent](#)

## RtspHeaders

RtspHeaders—Specifies RTSP headers.

### SYNOPSIS

```
set Traffic1_Network1 [::IxLoad new ixNetTraffic]
set Activity_RTSPClient1 [$Traffic1_Network1 activityList.appendItem
$Activity_RTSPClient1 agent.config
set my_RtspHeaders [::IxLoad new RtspHeaders]
```

### DESCRIPTION

RtspHeaders is an option of the `RTSP Client Agent` object and is used to specify the client emulation and hold a list of individual RTSP headers. See the following example below.

### SUBCOMMANDS

The options for this command are configured and read using the standard `config`, `cget`, and `getOption` subcommands defined in the `ixConfig` command.

### OPTIONS

`clientEmulation`

The RTSP client application that the client emulates. One of:

Option	Usage
<code>::RtspHeaders</code> ( <code>kClientEmulationTypeCustom</code> )	If this option is selected, the conof the <code>list</code> option should be used to specify the client and its options.
<code>::RtspHeaders</code> ( <code>kClientEmulationTypeQuicktime</code> )	(Default) Apple QuickTime version 6.5.
<code>::RtspHeaders</code> ( <code>kClientEmulationTypeWindowsMediaPlayer</code> )	Microsoft Windows Media Player.
<code>::RtspHeaders</code> ( <code>kClientEmulationTypeRealOne</code> )	Real Networks RealMedia Player.

`list`

This is a list of type `RtspHeader`. The elements in this list describe RTSP headers. (Default = {}).

### EXAMPLE

See the example for `RtspHeader`.

**SEE ALSO**

[RTSP Client Agent](#)

[RtspHeaders](#)

## RtspsetParamOptionList

Specifies the properties of the SET\_PARAMETER command.

### SYNOPSIS

```
set Traffic1_Network1 [::IxLoad new ixNetTraffic]
set Activity_RTSPClient1 [$Traffic1_Network1 activityList.appendItem
set Option1 [::IxLoad new SetParamOption]
$Activity_RTSPClient1 agent.setParamOptionList.appendItem -object $Option1
```

### DESCRIPTION

The SET\_PARAMETER command is added to the `commandList` option of the RTSP Client Agent object using the `appendItem` subcommand from the `ixConfigSequenceContainer` command. The string specified in the `arguments` field of the SET\_PARAMETER command appears as `name` in one of the entries of `setParamOptionList`.

### SUBCOMMANDS

None

### OPTIONS

`name`

Each user-specified `content` and `contentType` pair, has a name associated with it. This is by default `Option1`, `Option2`, and so on.

`content`

This is a user-specified string value specifying the content of the parameter. It is dependent on the server that the client is running on.

`contentType`

This is a user-specified string value specifying the content type of the parameter. It is dependent on the server that the client is running on.

### EXAMPLE

```
set my_RtspCommand1 [::IxLoad new RtspCommand]$my_RtspCommand1 config \-media
"None" \-destination "None" \-command
"SET_PARAMETER" \-arguments "Option1"$Activity_RTSPClient1
ent1 agent.commandList.appendItem -object $my_RtspCommand1$Activity_RTSPClient1
agent.setParamOptionList.clearset Option1 [::IxLoad new SetParamOption]$Option1 con-
fig \-content "12345" \-contentType
"12" \-name "Option1"$Activity_RTSPClient1 agent.-
setParamOptionList.appendItem -object $Option1
```

**SEE ALSO**

[RtspCommand](#)

[RTSP Client Agent](#)

## RtspgetParamOptionList

Specifies the properties of the GET\_PARAMETER command.

### SYNOPSIS

```
set Traffic1_Network1 [::IxLoad new ixNetTraffic]
set Activity_RTSPClient1 [$Traffic1_Network1 activityList.appendItem
set Option1 [::IxLoad new GetParamOption]
$Activity_RTSPClient1 agent.getParamOptionList.appendItem -object $Option1
```

### DESCRIPTION

The GET\_PARAMETER command is added to the `commandList` option of the RTSP Client Agent object using the `appendItem` subcommand from the `ixConfigSequenceContainer` command. The string specified in the `arguments` field of the GET\_PARAMETER command appears as `name` in one of the entries of `getParamOptionList`

### SUBCOMMANDS

None

### OPTIONS

`name`

Each user-specified `content` and `contentType` pair, has a name associated with it. This is by default `Option1`, `Option2`, and so on.

`content`

This is a user-specified string value specifying the content of the parameter. It is dependent on the server that the client is running on.

`contentType`

This is a user-specified string value specifying the content type of the parameter. It is dependent on the server that the client is running on.

### EXAMPLE

```
set my_RtspCommand1 [::IxLoad new RtspCommand]$my_RtspCommand1 config \-media
"None" \-destination "None" \-command
"GET_PARAMETER" \-arguments "Option1"$Activity_RTSPClient1
ent1 agent.commandList.appendItem -object $my_RtspCommand1$Activity_RTSPClient1
agent.getParamOptionList.clearset Option1 [::IxLoad new GetParamOption]$Option1 con-
fig \-content "12345" \-contentType
"12" \-name "Option1"$Activity_RTSPClient1 agent.-
getParamOptionList.appendItem -object $Option1
```



**SEE ALSO**

[RtspCommand](#)

[RTSP Client Agent](#)

## RTSP Server Agent

RTSP Server Agent

### SYNOPSIS

```
set Traffic2_Network2 [::IxLoad new ixNetTraffic]
set Activity_RTSPServer1 [$Traffic2_Network2 activityList.appendItem
$Activity_RTSPServer1 agent.config options...
```

### DESCRIPTION

An RTSP server agent is added to the `activityList` object. The `activityList` object is added to the `ixNetTraffic` object using the `appendItem` subcommand from the `ixConfigSequenceContainer` command.

Each member of the list, however may be separately addressed and modified using the `ixConfig` subcommands.

### SUBCOMMANDS

The options for this command are configured and read using the standard `config`, `cget`, and `getOption` subcommands defined in the `ixConfig` command.

### OPTIONS

`commandTimeout`

The amount of time, expressed in seconds, allowed for the RTSP client to respond to a message. If no response is received within this time, IxLoad closes the RTSP client's connection. (Default = 60).

`contentList`

This is a list of type `Content`. The elements in this list are the media types used in the `presentationList`. (Default = {}).

`enable`

Enables the use of this agent. (Default = true).

`enableEsm`

If true, the use of the `esm` option is enabled. (Default = false).

`enableTos`

Enables the setting of the TOS (Type of Service) bits in the header of the RTSP packets. Use the `tos` option to specify the TOS bit setting.

0	(default) TOS bits not enabled.
---	---------------------------------

1	TOS bits enabled.
---	-------------------

esm

If `enableEsm` is `true`, this option specifies the TCP Maximum Segment Size in the MSS (RX) field. Otherwise, the TCP Maximum Segment Size as 1,460 bytes. (Default = 1,460).

`enableVlanPriority`

VLAN Priority can be set on a per-activity basis or on a per-network (NetTraffic) basis. This parameter sets the VLAN priority for the activity. An activity's VLAN Priority bit setting takes precedence over a network's Priority bit setting. If `true`, `IxLoad` sets the VLAN Priority bit in traffic from this activity. Configure the VLAN priority value in `vlanPriority`. (Default = `false`).

`vlanPriority`

When `enableVlanPriority` is `true`, this option accepts the `vlan` priority value.

`name`

The name associated with this object, which must be set at object creation time.

`port`

The port number to which the RTSP server will respond. To specify multiple ports, separate the port numbers with commas (,). You can specify up to 50 listenports. (Default = 554).

`presentationList`

This is a list of type `PresentationItem`. The elements in this list are the presents available from the RTSP Server Agent. (Default = {}).

`serverEmulation`

The RTSP server application that the server emulates. One of:

Option	Usage
<code>::RTSP_Server</code> ( <code>kServerEmulationCustom</code> )	If this option is selected, the <code>conof</code> of the <code>list</code> option should be used to specify the client and its options.
<code>::RTSP_Server</code> ( <code>kServerEmulationQuicktime</code> )	(Default) Apple QuickTime version 6.5.
<code>::RTSP_Server</code> ( <code>kServerEmulationWindowsMediaPlayer</code> )	Microsoft Windows Media Player.
<code>::RTSP_Server</code> ( <code>kServerEmulationRealOne</code> )	Real Networks RealMedia Player.

`tos`

If `enableTos` is true, this option specifies the IP Precedence / TOS (Type of Service) bit setting and Assured Forwarding classes. (Default = "0"). The choices are:

0	(Default) (0x0000) routine
32	(0x0020) priority service, Assured Forwarding class 1
64	(0x0040) immediate service, Assured Forwarding class 2
96	(0x0060) flash, Assured Forwarding class 3
128	(0x0080) flash-override, Assured Forwarding class 4
160	(0x00A0) critical-ecp
192	(0x00C0) Internet-control

## STATISTICS

### EXAMPLE

```
set Traffic2_Network2 [::IxLoad new ixNetTraffic]
```

```
##### Activity RTSPServer1 of
NetTraffic Traffic2@Network2#####set
Activity_RTSPServer1 [$Traffic2_Network2 activityList.appendItem \-protocolAndType
"RTSP Server" ]set _Match_Longest_ [::IxLoad new ixMatchLongestTimeline]$Activity_
RTSPServer1 config \-enable true \-name
"RTSPServer1" \-timeline $_Match_Longest_$Activity_
RTSPServer1 agent.config \-enableTos 0 \-
commandTimeout 60 \-enable
true \-serverEmulation 0 \-name
"RTSPServer1" \-tos 0 \-rtpVlanPriority
0 \-enableEsm 0 \-rtspVlanPriority
0 \-esm 1460 \-enableRTSPVlanPriority
0 \-port 554 \-enableRTPVlanPriority
0$Activity_RTSPServer1 agent.presentationList.clearset MP3_128kbit [::IxLoad new Con-
tent]$MP3_128kbit config \-name
"MP3/128kbit"$MP3_128kbit streamList.clearset my_Stream [::IxLoad new Stream]$my_
Stream config \-clockRate "Audio MP3 (90000 Hz)" \-
dataRate 128.0 \-packetization
20$MP3_128kbit streamList.appendItem -object $my_Streamset my_PresentationItem
[::IxLoad new PresentationItem]$my_PresentationItem config \-duration
30 \-path "/test1.mp3" \-content
$MP3_128kbit$Activity_RTSPServer1 agent.presentationList.appendItem -object $my_
PresentationItem$Activity_RTSPServer1 agent.contentList.clearset Voice__1016_
[::IxLoad new Content]$Voice__1016_ config \-name
```

```
"Voice (1016)"$Voice__1016_ streamList.clearset my_Stream1 [::IxLoad new Stream]$my_
Stream1 config \-clockRate "Audio 8 bit (8000 Hz)" \-
dataRate 0.48 \-packetization
200$Voice__1016_ streamList.appendItem -object $my_Stream1$Activity_RTSPServer1
agent.contentList.appendItem -object $Voice__1016_
```

**SEE ALSO**

[ixNetTraffic](#)

[Content](#)

[PresentationItem](#)

## PresentationItem

PresentationItem—Specifies a presentation available from a server agent.

### SYNOPSIS

```
set Traffic2_Network2 [::IxLoad new ixNetTraffic]
set Activity_RTSPServer1 [$Traffic2_Network2 activityList.appendItem
set my_PresentationItem [::IxLoad new PresentationItem]
$Activity_RTSPServer1 agent.presentationList.appendItem -object $my_PresentationItem
```

### DESCRIPTION

A `PresentationItem` is added to the `presentationList` option of the `RTSP Server Agent` object using the `appendItem` subcommand from the `ixConfigSequenceContainer` command.

Each member of the list, however may be separately addressed and modified using the `ixConfig` subcommands.

### SUBCOMMANDS

The options for this command are configured and read using the standard `config`, `cget`, and `getOption` subcommands defined in the `ixConfig` command.

### OPTIONS

`content`

A reference to an item in the `contentList` option of the `RTSP Server Agent`. This must match the name of a `Content` object in the `contentList`. (Default = "").

`duration`

The maximum length of time that a stream will play, in seconds. (Default = 30).

`path`

The URL of the media file. (Default = "/test1.mp3").

### EXAMPLE

```
set my_PresentationItem [::IxLoad new PresentationItem]$my_PresentationItem config
\ -duration 30 \ -path
"/test1.mp3" \ -content $MP3_128kbit$Activity_
RTSPServer1 agent.presentationList.appendItem -object $my_PresentationItem
```

### SEE ALSO

[RTSP Server Agent](#)

[Content](#)

## Stream

Stream—Specifies a stream used in a presentation item.

### SYNOPSIS

```
set Traffic1_Network1 [::IxLoad new ixNetTraffic]
set Activity_RTSPClient1 [$Traffic1_Network1 activityList.appendItem
set my_Stream [::IxLoad new Stream]
set MP3_128kbit [::IxLoad new Content]
$MP3_128kbit streamList.appendItem -object $my_Stream
$Activity_RTSPServer1 agent.presentationList.appendItem -object $my_PresentationItem
```

### DESCRIPTION

A **Stream** object is a part of a **Content** object that is part of a **PresentationItem** object, which is a member of a **RTSP Server Agent** object. Its options are configas per the **ixConfig** subcommands.

### SUBCOMMANDS

The options for this command are configured and read using the standard **config**, **cget**, and **getOptions** subcommands defined in the **ixConfig** command.

### OPTIONS

**clockRate**

The rate at which a sound or moving image is sampled in order to represent it digitally, expressed in hertz. Note: An integer value must be used. (Default = 90,000). Some typical values are::

Usage	Rate
Audio MP3	90000 Hz
Audio 8 bit	8000 Hz
Audio 16 bit	16000 Hz
Video	90000 Hz

**dataRate**

The rate at which data is sent, expressed in kbps. (Default = 128).

**packetization**

The amount of time elapsed between packets, in milliseconds. (Default = 20).

### EXAMPLE

```
set my_Stream [::IxLoad new Stream]$my_Stream config \-clockRate
```

```
"Audio MP3 (90000 Hz)" \-dataRate          128.0 \-  
packetization          20$MP3_128kbit streamList.appendItem -object  
$my_Stream
```

### **SEE ALSO**

[Content](#)

[RTSP Server Agent](#)



## Content

Content — Specifies the streams that compose a presentation item.

### SYNOPSIS

```
set Traffic2_Network2 [::IxLoad new ixNetTraffic]
set Activity_RTSPServer1 [$Traffic2_Network2 activityList.appendItem
set MP3_128kbit [::IxLoad new Content]
$MP3_128kbit streamList.appendItem -object $my_Stream
$Activity_RTSPServer1 agent.presentationList.appendItem -object $my_PresentationItem
```

### DESCRIPTION

A **Content** object is a part of a **PresentationItem** object, which is a member of a **RTSP Server Agent** object. Its options are configured as per the **ixConfig** sub-commands.

### SUBCOMMANDS

The options for this command are configured and read using the standard **config**, **cget**, and **getOption** subcommands defined in the **ixConfig** command.

### OPTIONS

**name**

The name associated with the streams. (Default = "MP3/128kbit").

**streamList**

This is a list of type **Stream**. The elements in this list are the streams that coma presentation. (Default = {}).

### EXAMPLE

```
set MP3_128kbit [::IxLoad new Content]$MP3_128kbit config \-name
"MP3/128kbit"$MP3_128kbit streamList.clearset my_Stream [::IxLoad new Stream]$my_
Stream config \-clockRate "Audio MP3 (90000 Hz)" \-
dataRate 128.0 \-packetization
20$MP3_128kbit streamList.appendItem -object $my_Streamset my_PresentationItem
[::IxLoad new PresentationItem]$my_PresentationItem config \-duration
30 \-path "/test1.mp3" \-content
$MP3_128kbit$Activity_RTSPServer1 agent.presentationList.appendItem -object $my_
PresentationItem
```

### SEE ALSO

[PresentationItem](#)

[RTSP Server Agent](#)

[Stream](#)



## RTSP Statistics

For the RTSP statistics, see the following:

[RTSP Client Statistics](#)

[RTSP Server Statistics](#)

For TCP statistics, see [TCP, Run State, and Curve Segment Statistics](#).

Statistics in the results files and reports are averaged over all ports. If a statistic for an interval is missing, IxLoad interpolates it from the statistic immediately prior to it and the statistic after it.

The test results are available from the location defined on the User Directories window. See User Directories.

If you review your statistics and find many instances of RTSP client statistics and server statistics that should match but do not, that may be an indication that the Ramp Down Time is too short. When the Ramp Down Time expires, IxLoad terminates any users that are still running. If those users still have work in progress (such as transferring data) when IxLoad terminates them, the work will not be completed and the effect will be that statistics that should match (such as Bytes Sent) may not.

## RTSP Client Statistics

The table below describes the statistics available for RTSP clients.

The QoE Detective column indicates the views in which a statistic is available:

**IP:** per-IP view

**User:** per-User view

**VLAN:** per-VLAN view

**All:** all views

Statistic	QoE Detective	Description
RTSP Simulated Users	--	Number of simulated RTSP users.
RTSP Concurrent Sessions	--	Number of concurrent RTSP sessions maintained.
RTSP Connections	All	Number of RTSP connections established.
RTSP Connection Rate	All	Rate at which the client established RTSP connections.
RTSP Transactions	All	Number of RTSP transactions completed.
RTSP Transaction Rate	All	Rate at which the client completed RTSP transactions.
RTP Lost Packets	All	Number of RTP packets lost during transmission.
RTP Out Of Order Packets	All	Number of RTP packets received out of order.
RTP Concurrent Sessions	--	Number of concurrent RTP sessions established.
RTSP Presentations Active	--	Number of RTSP presentations playing or paused.
RTSP Presentations Playing	--	Number of presentations playing.

RTSP Presentations Paused	--	Number of presentations paused.
RTSP Presentation Requests Successful	--	Number of presentations requests that succeeded.
RTSP Presentation Requests Failed	--	Number of presentations requests that failed.
RTSP Presentations Playback Successful	--	Number of RTSP presentation requests that resulted in actual RTP data being received by the client. This statistic is incremented only once for each successful RTSP PLAY command, even if a PLAY results in multiple RTP streams being received (for example, a video and an audio stream).
RTSP DESCRIBE Sent	All	Number of RTSP DESCRIBE messages sent.
RTSP SETUP Sent	All	Number of RTSP SETUP messages sent.
RTSP SET PARAMETER Sent	All	Number of RTSP SET PARAMETER messages sent.
RTSP GET PARAMETER Sent	All	Number of RTSP GET PARAMETER messages sent.
RTSP PLAY Sent	All	Number of RTSP PLAY commands sent.
RTSP PAUSE Sent	All	Number of RTSP PAUSE commands sent.
RTSP TEARDOWN Sent	All	Number of RTSP TEARDOWN commands sent.
RTSP DESCRIBE Successful	All	Number of RTSP DESCRIBE commands for which a successful response was received.

RTSP SETUP Successful	All	Number of RTSP SETUP commands for which a successful response was received.
RTSP SET PARAMETER Successful	All	Number of SET_PARAMETER replies received with code OK (200).
RTSP GET PARAMETER Successful	All	Number of RTSP GET PARAMETER commands for which a successful response was received.
RTSP PLAY Successful	All	Number of RTSP PLAY commands for which a successful response was received.
RTSP PAUSE Successful	All	Number of RTSP PAUSE commands for which a successful response was received.
RTSP TEARDOWN Successful	All	Number of RTSP TEARDOWN commands for which a successful response was received.
RTSP DESCRIBE Failed	All	Number of RTSP DESCRIBE commands that failed.
RTSP SETUP Failed	All	Number of RTSP SETUP commands that failed.
RTSP SET PARAMETER Failed	All	Number of SET_PARAMETER replies received with a code other than OK (200).
RTSP GET PARAMETER Failed	All	Number of RTSP GET PARAMETER commands that failed.
RTSP PLAY Failed	All	Number of RTSP PLAY commands that failed.
RTSP PAUSE Failed	All	Number of RTSP PAUSE commands that failed.
RTSP TEARDOWN Failed	All	Number of RTSP TEARDOWN commands that failed.

RTSP Presentations Requested	All	Number of presentation requests sent.
RTSP Presentations Successful	All	Number of presentations received.
RTSP Presentations Failed	All	Number of presentations requested but not received.
RTSP Presentations Active	All	Number of presentations active.
RTSP Presentations Playing	All	Number of presentations playing.
RTSP Presentations Paused	All	Number of presentations paused.
RTP Packets Received	All	Number of RTP packets received.
RTP Bytes Received	All	Number of RTP bytes received.
RTSP Packets Sent	All	Number of RTSP packets received.
RTSP Packets Received	All	Number of RTSP packets received.
RTSP Bytes Sent	All	Number of RTSP bytes transmitted. If you run RTP over TCP, the media uses the same channel opened by the RTSP connection, so RTSP Bytes Sent also counts the bytes sent in the RTP stream.
RTSP Bytes Received	All	Number of RTSP bytes received. If you run RTP over TCP, the media uses the same channel opened by the RTSP connection, so RTSP Bytes Received also counts the bytes received in the RTP stream.

RTSP Setup Latency (ms)	All	Amount of time elapsed, in milliseconds, between a client sending a request to establish an RTSP connection and receiving the first byte of the response. Note for Tcl API users: This is a weighted statistic. If you are using this statistic in a Tcl script, use the <i>kWeightedAverage</i> aggregation type.
RTSP Tear-down Latency (ms)	All	Amount of time elapsed, in milliseconds, between a client sending a request to end an RTSP connection and receiving the first byte of the response. Note for Tcl API users: This is a weighted statistic. If you are using this statistic in a Tcl script, use the <i>kWeightedAverage</i> aggregation type.
RTSP Play Latency (ms)	All	Amount of time elapsed, in milliseconds, between a client sending a PLAY command and receiving the first byte of the media stream. Note for Tcl API users: This is a weighted statistic. If you are using this statistic in a Tcl script, use the <i>kWeightedAverage</i> aggregation type.
RTSP Play Latency (0 ms - 10 ms)	All	Number of instances in which 0 to 10 milliseconds elapsed between the time a client sent a PLAY command and the time it received the first byte of the media stream.
RTSP Play Latency (10 ms - 50 ms)	All	Number of instances in which 10 to 50 milliseconds elapsed between the time a client sent a PLAY command and the time it received the first byte of the media stream.
RTSP Play Latency (50 ms - 100 ms)	All	Number of instances in which 50 to 100 milliseconds elapsed between the time a client sent a PLAY command and the time it received the first byte of the media stream.
RTSP Play Latency (100 ms - 300 ms)	All	Number of instances in which 100 to 300 milliseconds elapsed between the time a client sent a PLAY command and the time it received the first byte of the media stream.
RTSP Play Latency (300 ms - 1s)	All	Number of instances in which 300 to 1000 milliseconds elapsed between the time a client sent a PLAY command and the time it received the first byte of the media stream.
RTSP Play Latency (Greater Than 1s)	All	Number of instances in which more than one second elapsed between the time a client sent a PLAY command and the time it received the first byte of the media stream.



RTP Jitter (0 ms - 50 ms)	All	Number of RTP packets received 0 to 50 milliseconds after the previous packet. Note: The ideal value for the 'delta' in packet arrival times is equal to the duration of the media transported in the packets. For example, if a packet contains 250ms of media, it should ideally arrive 250ms after the preceding packet.
RTP Jitter (50 ms - 100 ms)	All	Number of RTP packets received 50 to 100 milliseconds after the previous packet in the stream.
RTP Jitter (100 ms - 150 ms)	All	Number of RTP packets received 100 to 150 milliseconds after the previous packet in the stream.
RTP Jitter (150 ms - 200 ms)	All	Number of RTP packets received 150 to 200 milliseconds after the previous packet in the stream.
RTP Jitter (200 ms - 250 ms)	All	Number of RTP packets received 200 to 250 milliseconds after the previous packet in the stream.
RTP Jitter (250 ms - 300 ms)	All	Number of RTP packets received 250 to 300 milliseconds after the previous packet in the stream.
RTP Jitter (300 ms - 400 ms)	All	Number of RTP packets received 300 to 400 milliseconds after the previous packet in the stream.
RTP Jitter (400 ms - 500 ms)	All	Number of RTP packets received 400 to 500 milliseconds after the previous packet in the stream.
RTP Jitter (500 ms - 700 ms)	All	Number of RTP packets received 500 to 700 milliseconds after the previous packet in the stream.
RTP Jitter (700 ms - 1000 ms)	All	Number of RTP packets received 700 to 1000 milliseconds after the previous packet in the stream.
RTP Jitter (1 s - 3 s)	All	Number of RTP packets received 1 to 3 seconds after the previous packet in the stream.
RTP Jitter (Greater Than 3s)	All	Number of RTP packets received more than 3 seconds after the previous packet in the stream.
RTP Bandwidth Usage (0 - 30 KB/s)	All	Amount of time during which RTP bandwidth usage was between 0 and 30 kilobits per second.

RTP Bandwidth Usage (30 KB/s - 100 KB/s)	All	Amount of time during which RTP bandwidth usage was between 30 and 100 kilobits per second.
RTP Bandwidth Usage (100 KB/s - 300 KB/s)	All	Amount of time during which RTP bandwidth usage was between 100 and 300 kilobits per second.
RTP Bandwidth Usage (300 KB/s - 1 MB/s)	All	Amount of time during which RTP bandwidth usage was between 300 kilobits and 1 megabit per second.
RTP Bandwidth Usage (Greater Than 1 MB/s)	All	Amount of time during which RTP bandwidth usage exceeded 1 megabit per second.
RTP Packet Loss Distribution (0 Percent)	All	Amount of time during which 0 percent of packets were lost.
RTP Packet Loss Distribution (0 - 0.1 Percent)	All	Amount of time during which 0 to 0.1 percent of packets were lost.
RTP Packet Loss Distribution (0.1 - 0.5 Percent)	All	Amount of time during which 0.1 to 0.5 percent of packets were lost.
RTP Packet Loss Distribution (0.5 - 2 Percent)	All	Amount of time during which 0.5 to 2 percent of packets were lost.
RTP Packet Loss Distribution (2 - 5 Percent)	All	Amount of time during which 2 to 5 percent of packets were lost.

RTP Packet Loss Distribution (5 - 100 Percent)	All	Amount of time during which 5 to 100 percent of packets were lost.
OK Responses Received	All	Number of RTSP OK messages received. This statistic is only available in Conditional View.
Error Responses Received	All	Number of RTSP error messages received. This statistic is only available in Conditional View.



**Note:** If the average table and bar graphs do not contain any data for the clients, that is an indication that they did not reach the Sustained (SU) run state. This can be caused by the following:

1. Stopping a test during the Ramp-Up phase.
2. Configuring a large number of page requests for the client agent so that not all the users configured for the client can attain the SU state within the allotted time.
3. Configuring a value for the statistics interval (Statistics tab) which is much larger than the SU time.

## Matching the TEARDOWN Statistics to Other Statistics

When you review the statistics from an RTSP test, you may find that the number of TEARDOWN commands does not match the numbers of other commands. The cause may be that the test entered the ramp down phase sooner than expected. For example:

**Describe command:** If an IxLoad RTSP client receives a response to a DESCRIBE command and then the test enters the ramp down phase, the test does not send a TEARDOWN command, because no session has been set up. In this case, the number of DESCRIBE and TEARDOWN commands will not match.

**PLAY command:** For the PLAY command, sending of TEARDOWN commands depend on whether the requested media stream plays to its end or not:

- If an IxLoad RTSP client receives a response to a PLAY command (the response being the requested media stream), the media stream plays to its end and then the test enters the Ramp Down phase. The test sends its own implicit TEARDOWN command immediately afterwards to allow the test to complete gracefully. In this case, the number PLAY commands should match the number of TEARDOWN commands.

- If the test enters the ramp down phase while the media stream is still playing, the test will not send a TEARDOWN command. In this case, the number of PLAY and TEARDOWN commands will not match, and the session will not be torn down gracefully. IxLoad will display a warning message.

**All other commands:** If an IxLoad RTSP client receives a response to a command other than DESCRIBE or PLAY and then the test enters the Ramp Down phase, the test sends its own implicit TEARDOWN command to allow the test to complete gracefully. In this case, the number of each command sent should match the number of TEARDOWN commands.

To cause the statistics for TEARDOWN to match those of other commands, you can either increase the test duration or select shorter media streams.

## RTSP Server Statistics

The table below describes the statistics available for RTSP servers.

The QoE Detective column indicates the views in which a statistic is available:

**IP:** per-IP view

**User:** per-User view

**VLAN:** per-VLAN view

**All:** all views

Statistic	QoE Detective	Description
RTSP Presentations Received	IP, VLAN	Number of presentation requests received by the servers.
RTSP Presentations Successful	IP, VLAN	Number of presentation requests that succeeded.
RTSP Presentations Failed	IP, VLAN	Number of presentation requests that failed.
RTSP Commands Received	IP, VLAN	Number of RTSP commands received.
RTSP DESCRIBE Received	IP, VLAN	Number of RTSP DESCRIBE commands received.
RTSP SETUP Received	IP, VLAN	Number of RTSP SETUP commands received.
RTSP PLAY Received	IP, VLAN	Number of RTSP PLAY commands received.
RTSP PAUSE Received	IP, VLAN	Number of RTSP PAUSE commands received.
RTSP TEARDOWN Received	IP, VLAN	Number of RTSP TEARDOWN commands received.
RTSP Response Codes Sent (2xx)	IP, VLAN	Number of 200-range (Success) responses sent. A 200-range response indicates that the action was successfully received, understood, and accepted.

RTSP Response Codes Sent (3xx)	IP, VLAN	Number of 300-range (Redirection) responses sent. A 300-range response indicates that further action must be taken in order to complete the request.
RTSP Response Codes Sent (4xx)	IP, VLAN	Number of 400-range (Client Error) responses sent. A 400-range response indicates that the request contains bad syntax or cannot be fulfilled.
RTSP Response Codes Sent (5xx)	IP, VLAN	Number of 500-range (Server Error) responses sent. A 500-range response indicates that the server failed to fulfill an apparently valid request.
RTSP Response Codes Sent (6xx- 1xxx)	IP, VLAN	Number of 600- to 1000-range responses sent.
RTSP Packets Sent	IP, VLAN	Number of RTSP packets transmitted by the servers.
RTSP Packets Received	IP, VLAN	Number of RTSP packets received by the servers.
RTSP Bytes Sent	IP, VLAN	Number of RTSP-related bytes (commands and responses) transmitted by the servers. If you run RTP over TCP, the media uses the same channel opened by the RTSP connection, so RTSP Bytes Sent also counts the bytes sent in the RTP stream.
RTSP Bytes Received	IP, VLAN	Number of RTSP-related bytes (commands and responses) received by the servers. If you run RTP over TCP, the media uses the same channel opened by the RTSP connection, so RTSP Bytes Received also counts the bytes received in the RTP stream.
Total RTP Bytes Sent	IP, VLAN	Number of RTP bytes transmitted by the servers.
Total RTP Packets Sent	IP, VLAN	Number of RTP packets transmitted by the servers.
Total UDP Packets Sent	IP, VLAN	Number of UDP packets transmitted by the servers.

---

RTSP Play Latency (ms)	IP, VLAN	<p>Average amount of time elapsed, in milliseconds, between the time a server received a PLAY request and the time it transmitted the first byte of the media stream.</p> <p>Note for Tcl API users: This is a weighted statistic. If you are using this statistic in a Tcl script, use the <i>kWeightedAverage</i> aggregation type.</p>
------------------------	----------	---

This page intentionally left blank.



# SMTP

This section describes the SMTP Tcl API objects.

## Overview

SMTP protocol commands are organized as:

SMTP Client Agent

- SmtplibCommand
- MailMessage
- Header
- Attachment

SMTP Server Agent

## Objectives

The objectives (userObjective) you can set for SMTP are listed below. Test objectives are set in the ixTimeline object.

- connectionRate
- transactionRate
- simulatedUsers
- concurrentConnections
- throughputMbps
- throughputKbps
- throughputGbps

## SMTP Client Agent

The SMTP Client Agent defines a simulated user performing SMTP requests against one or more SMTP servers. Refer to **SMTP Client Agent** for a full description of this command. The important options of this command are listed below.

Option	Usage
enable	Enables the use of the SMTP client agent.
name	The name associated with the client agent.
helloType	The type of hello (HELO or EHLO) used.
commandList	A list of commands to be sent to the server. Each list member is of type <code>Smt-pCommand</code> .
mailMessageList	A list of mail messages used in various commands contained in the <i>commandList</i> . Each list member is of type <code>MailMessage</code> .
commandTimeout	Client timeout value.

### Smt-pCommand

Each client command is a single step in the interaction. Refer to **Smt-pCommand** for a full description of this command. The important subcommands and options of this command are listed below.

Subcommand	Usage
checkConfig	Checks the configuration of the action.

Option	Usage
command arguments	The SMTP command, with optional arguments, to be executed.
destination	The name/address of the SMTP server.
mailMessage	A reference to a mail message in the SMTP Client Agent's <i>mailMessageList</i> .

## MailMessage

The MailMessage object embodies a set of mail messages, complete with headers and attachments. Refer to **MailMessage** for a full description of this command. The important options of this command are listed below.

Option	Usage
name	The name associated with the mail message.
bodyFormat	The type of contents for the body of the message: text or HTML.
bodySizeType bodySizeFixed bodySizeRandomMin bodySizeRandomMax	Controls the size of the body of the message.
headerList	A set of headers to accompany the mail message. Each member is of type Header.
attachmentList	A set of attachments to accompany the mail message. Each member is of type Attachment.

## Header

The Header object embodies a single mail header for use with a mail message. Refer to Header for a full description of this command. The important options of this command are:

Option	Usage
name	An e-mail header item. For example, From or To.
value / data	The text for the e-mail header item. For example, "john@smith.org".

## Attachment

The *Attachment* object embodies a set of mail attachments, which may be included with a mail message. Refer to **Attachment** for a full description of this command. The important options of this command are listed below.

Option	Usage
dataType	The type of contents for the body of the attachment: text or HTML.
type fileName sizeMin sizeMax	Controls whether the attachment is taken from a file or generated within a size range.
countMin countMax	Controls how many attachments of this type are attached to a mail message.

## SMTP Server Agent

The SMTP Server Agent defines the operation of the SMTP server. The emulated SMTP Server Agent accepts all mail messages sent to it, so it has few options. Refer to **SMTP Server Agent** for a full description of this command. The impropertions of this command are listed below.

Option	Usage
enable	Enables the use of this server agent.
name	The name associated with the server agent.
concurrentSessionLimit	The maximum number of concurrent sessions that the server will allow.
Server_Listening_Port	Port that the SMTP server listens on for new connections.

## SMTP Client Agent

SMTP Client Agent - create an SMTP client

### SYNOPSIS

```
set Traffic1_Network1 [::IxLoad new ixNetTraffic]set Activity_SMTPClient1 [$Traffic1_Network1 activityList.appendItem$Activity_SMTPClient1 agent.config options...
```

### DESCRIPTION

An SMTP client agent is added to the **activityList** object. The *activityList* object is added to the *ixNetTraffic* object using the *appendItem* subcommand from the **ixConfigSequenceContainer** command.

Each member of the list, however may be separately addressed and modified using the **ixConfig** subcommands.

### SUBCOMMANDS

The options for this command are configured and read using the standard *config*, *cget*, and *getOptions* subcommands defined in the **ixConfig** command.

### OPTIONS

commandList

This is a list of type *ixConfigSequenceContainer* used to hold objects of type *SmtplibCommand*. The elements in this list describe the commands to be executed by the agent. (*Default = {}*).

commandTimeout

Amount of time allowed for an SMTP command to complete. If the command does not complete within the allowed time, IxLoad closes the SMTP client's connection to the SMTP server. (*Default = 120*).

enable

Enables the use of this agent. (*Default = true*).

helloType

Type of HELLO command used by this SMTP client. One of: :

Option	Usage
<code>::SMTP_Client (kHelloTypeEhlo)</code>	( <i>Default</i> ) EHLO. The Enhanced SMTP (ESMTP) version of HELO. The server's response includes a list of the options that the server supports.
<code>::SMTP_Client (kHelloTypeHelo)</code>	HELO. The sender-SMTP sends a HELO to the receiver-SMTP to identify itself and open a connection. An argument sent with the command contains the host name of the sender-SMTP.

### ipPreference

This option indicates the order by which the POP3 client will use the subnets, if there is a mixture of IPv4 and IPv6 subnets in the network. The values are: IpPreferenceV4, IpPreferenceV6, IpPreferenceV4Any, IpPreferenceV6Any.

### loopValue

If this option is enabled (*1*), then the client progresses through the command list repeatedly until the test's sustain time. If the option is disabled (*0*), then the client will progress through the command list only once, and then go idle. (*Default = 0*).

### mailMessageList

This is a list of type **ixConfigSequenceContainer** used to hold objects of type **MailMessage**. The elements in this list are used as the contents of messages transmitted by the client. (*Default = {}*).

### name

The name associated with this object, which must be set at object creation time.

### enableVlanPriority

VLAN Priority can be set on a per-activity basis or on a per-network (NetTraffic) basis. This parameter sets the VLAN priority for the activity. An activity's VLAN Priority bit setting takes precedence over a network's Priority bit setting. If *true*, IxLoad sets the VLAN Priority bit in traffic from this activity. Configure the VLAN priority value in *vlanPriority*. (*Default = false*).

### vlanPriority

When *enableVlanPriority* is *true*, this option accepts the vlan priority value.

## STATISTICS

### EXAMPLE

```
set Traffic1_Network1 [::IxLoad new
ixNetTraffic]##### Activity SMTPClient1
of NetTraffic Traffic1@Network1#####set
Activity_SMTPLClient1 [$Traffic1_Network1 activityList.appendItem \-protocolAndType
"SMTP Client" ]##### Timelinel for
activities SMTPLClient1#####set Timelinel
[::IxLoad new ixTimeline]$Timelinel config \-rampUpValue
1 \-rampUpType 0 \-offlineTime
0 \-rampDownTime 20 \-standbyTime
0 \-iterations 1 \-rampUpInterval
1 \-sustainTime 20 \-timelineType
0 \-name "Timelinel"$Activity_SMTPLClient1 config
```

```

\enable 1 \-name
"SMTPClient1" \-enableConstraint false \-userObjectiveValue
100 \-constraintValue 100 \-userObjectiveType
"simulatedUsers" \-timeline $Timeline1$Activity_
SMTPClient1 agent.config \-loopValue true \-
commandTimeout 120 \-enable
1 \-ipPreference 2 \-name
"SMTPClient1" \-vlanPriority 0 \-helloType
0 \-enableVlanPriority true$Activity_SSMTPClient1 agent.-
mailMessageList.clearset Simple [::IxLoad new MailMessage]$Simple config \-
bodySizeType 0 \-name
"Simple" \-fileNameAsBody "" \-description
"100 bytes plain text body" \-textContentAsBody "" \-
bodySizeRandomMax 4096 \-bodySizeFixed
100 \-mimeTypeAndEncode 0 \-bodySizeRandomMin
1 \-bodyDataType 0 \-useFileAsBody
true \-bodyFormat 0$Simple headerList.clearset From
[::IxLoad new MailHeader]$From config \-name
"From" \-value "fromName@company.com"$Simple head-
erList.appendItem -object $Fromset To [::IxLoad new MailHeader]$To config \-name
"To" \-value "toName@company.com"$Simple head-
erList.appendItem -object $Toset Subject [::IxLoad new MailHeader]$Subject config \-
name "Subject" \-value
"sample subject"$Simple headerList.appendItem -object $Subject$Simple attach-
mentList.clear$Activity_SSMTPClient1 agent.mailMessageList.appendItem -object $Simple

```

**SEE ALSO**[ixNetTraffic](#)[SmtplibCommand](#)[MailMessage](#)[Attachment](#)[Header](#)

## SmtplibCommand

SmtplibCommand—Specifies the contents of an SMTP command.

### SYNOPSIS

```
set Traffic1_Network1 [::IxLoad new ixNetTraffic]set Activity_SMTPClient1 [$Traffic1_Network1 activityList.appendItemset my_SmtplibCommand [::IxLoad new SmtplibCommand]$Activity_SMTPClient1 agent.commandList.appendItem -object $my_SmtplibCommand
```

### DESCRIPTION

An *SmtplibCommand* object is added to the *commandList* option of the **SMTP Client Agent** object using the *appendItem* subcommand from the **ixConfigSequenceContainer** command.

Each member of the list, however may be separately addressed and modified using the **ixConfig** subcommands.

### SUBCOMMANDS

The options for this command are configured and read using the standard *config*, *cget*, and *getOptions* subcommands defined in the **ixConfig** command.

### OPTIONS

arguments

Optional arguments related to the SMTP command to be executed. One of:

Option	Usage
"{Send}"	N/A.
"OPEN"	N/A.
"MAIL"	The number of copies of the selected mail message to transfer. ( <i>Default = 10</i> ).
"NOOP"	N/A.
"RSET"	N/A.
"{Think}"	The length of the pause, in seconds, in the <i>arguments</i> option. ( <i>Default = 1</i> ).
"QUIT"	N/A.

command

The SMTP command to be executed. One of:



Option	Usage
"{Send}"	<i>(Default)</i> An IxLoad command that opens a connection to the SMTP server, transfers all configured messages to it, then logs out. {Send} is a single command that performs the same function as multiple SMTP commands. However, {Send} is not a standard SMTP command. It is included in IxLoad for your convenience to make configuring SMTP clients easier.
"OPEN"	Opens a connection to the SMTP server.
"MAIL"	Initiates a transaction that transfers mail messages to an SMTP server. In the <i>arguments</i> option, specify the number of copies of the selected mail message to transfer.
"NOOP"	(NO OPERATION) specifies no action other than that the receiver send an OK reply.
"RSET"	Aborts the current mail transaction. Any stored sender, recipients, and mail data are discarded. A client can issue a RSET command at any time.
"{Think}"	Pauses the mail transaction. Specify the length of the pause, in seconds in the <i>arguments</i> option.
"QUIT"	Closes the transmission channel.
"{LoopBegin}"	An IxLoad command that you can add to the Command List to cause the commands between it and the {Loop End} to be executed a specified number of times.
"{LoopEnd}"	Ends the list of commands that will be executed by the preceding {Loop Begin} command.

destination

The SMTP server that the client will send the command to. Specify the destination as follows:

- If the destination is a real SMTP server, specify the server's host name or IP address.
- If the destination is an IxLoad SMTP Server Agent, specify the name of the SMTP Server Agent.
- If the destination is the DUT, specify DUT:n – where DUT is the name of the DUT and n is the port number on that DUT.

(Default = "198.18.1.1").

mailMessage

A reference to an instance of the *MailMessage* object. (Default = "").

### EXAMPLE

```
set my_SmtpCommand [::IxLoad new SmtplibCommand]$my_SmtpCommand config \-destination
"Traffic2_SMTPServer1" \-command "{Send}" \-
arguments "10" \-mailMessage
$Simple1$Activity_SMTPClient1 agent.commandList.appendItem -object $my_SmtpCommand
```

**SEE ALSO**

[SMTP Client Agent](#)

[MailMessage](#)

## Header

Header—Specifies the contents of a mail message header.

### SYNOPSIS

```
set Traffic1_Network1 [::IxLoad new ixNetTraffic]
set Activity_SMTPClient1 [$Traffic1_Network1 activityList.appendItem
$AttachmentSmall attachmentList.appendItem -object $my_MailAttachment
$Activity_SMTPClient1 agent.mailMessageList.appendItem -object $Attach
set From4 [::IxLoad new MailHeader]
$AttachmentSmall headerList.appendItem -object $From4
```

### DESCRIPTION

A **Header** object is added to the `headerList` option of a `MailMessage` object, which is list item in of the `mailMessageList` option of the `SMTP Client Agent` object. Three required header items are included by default:

- From
- To
- Subject

### SUBCOMMANDS

The options for this command are configured and read using the standard `config`, `cget`, and `getOptions` subcommands defined in the `ixConfig` command.

### OPTIONS

name

The e-mail header item. Example: `From, To, Subject`. (Default = `From, To`). The standard headers that `IxLoad` supports are:

Option	Usage
From	From
To	To
Subject	Subject
Cc	Carbon copy.
Bcc	Blind carbon copy.

In addition you can include your own custom headers by editing the header fields. You can enter any printable US ASCII characters into the fields, except the space ( ) and the colon (:). The custom headers accepts MIME type headers also. MIME type headers start with "Content-."

value / data

The text which forms the header. (Default = "fromName@company.com").

### EXAMPLE

```
set From [::IxLoad new MailHeader]$From config \-name
"From" \-value "fromName@company.com"$Simple head-
erList.appendItem -object $From
```

### SEE ALSO

[MailMessage](#)

[SMTP Client Agent](#)

## Attachment

Attachment—Specifies the contents of a mail attachment.

### SYNOPSIS

```
set Traffic1_Network1 [::IxLoad new ixNetTraffic]
set Activity_SMTPClient1 [$Traffic1_Network1 activityList.appendItem
set my_MailAttachment [::IxLoad new MailAttachment]
$AttachmentSmall attachmentList.appendItem -object $my_MailAttachment
$Activity_SMTPClient1 agent.mailMessageList.appendItem -object $Attach
```

### DESCRIPTION

An `Attachment` object is added to the `attachmentList` option of a `MailMessage` object, which is list item in of the `mailMessageList` option of the `SMTP Client Agent` object.

### SUBCOMMANDS

The options for this command are configured and read using the standard `config`, `cget`, and `getOptions` subcommands defined in the `IxConfig` command.

### OPTIONS

`countMax`

The upper limit on the number of attachments attached to each message. IxLoad attaches a varying number of attachments of this type. (Default = 3).

`countMin`

The lower limit on the number of attachments attached to each message. IxLoad attaches a varying number of attachments of this type. (Default = 1).

`dataType`

If *type* is set to `::Attachment(kGeneratedData)`, this field specifies the format of the generated data. You can select from the following formats:

Option	Usage
<code>::Attachment(kPlainText)</code> or "Plain Text"	(Default) IxLoad generates ASCII text for the attachment.
<code>::Attachment(kHtml)</code> or "HTML"	IxLoad generates text for the attachment that includes HTML tags.

\$:Attachment (kRandom) or "Random"	IxLoad randomly generates plain text for some instances of this attachment, and HTML for other instances.
-------------------------------------	---

fileName

If *type* is set to `$:Attachment(kExistingFile)`, this field specifies the file to be attached. You can specify any file on the local IxLoad client PC or accessible over your network. (Default = "<specify file>").

sizeMax

If *type* is set to `$:Attachment(kGeneratedData)`, this specifies the upper limit of the size of the attachment. IxLoad generates attachments that vary randomly between the minimum and maximum sizes. (Default = 4,096).

sizeMin

If *type* is set to `$:Attachment(kGeneratedData)`, this specifies the lower limit of the size of the attachment. IxLoad generates attachments that vary randomly between the minimum and maximum sizes. (Default = 1,024).

type

The type of data contained in the attachment. One of:

Option	Usage
\$:Attachment (kGeneratedData) or "Generated Data"	(Default) IxLoad automatically creates random data in the attachment. Use the <i>dataType</i> option to specthe format of the generated data.
\$:Attachment (kExistingFile) or "Existing File"	IxLoad attaches the file specified in the <i>fileName</i> option to the message.

## EXAMPLE

```
set my_MailAttachment [::IxLoad new MailAttachment]$my_MailAttachment config \-
sizeMax                100 \-countMax
1 \-dataType            0 \-countMin
1 \-fileName            "<specify file>" \-attchStr
"" \-type                0 \-sizeMin
100$AttachmentSmall attachmentList.appendItem -object $my_MailAttachment$Activity_
SMTPClient1 agent.mailMessageList.appendItem -object $AttachmentSmall
```

**SEE ALSO**

[MailMessage](#)

[SMTP Client Agent](#)

## MailMessage

MailMessage—Specifies the contents of a mail message.

### SYNOPSIS

```
set Traffic1_Network1 [::IxLoad new ixNetTraffic]set Activity_SMTPClient1 [$Traffic1_Network1 activityList.appendItemset Simple [::IxLoad new MailMessage]$Activity_SMTPClient1 agent.mailMessageList.appendItem -object $Simple
```

### DESCRIPTION

A `MailMessage` object is added to the `mailMessageList` option of the `SMTP Client Agent` object using the `appendItem` subcommand from the `ixConfigSequenceContainer` command.

Each member of the list, however may be separately addressed and modified using the `ixConfig` subcommands.

### SUBCOMMANDS

The options for this command are configured and read using the standard `config`, `cget`, and `getOption` subcommands defined in the `ixConfig` command.

### OPTIONS

`attachmentList`

This is a list of type `Attachment`. The elements in this list are the attachments associated with the mail message. (Default = {}).

`bodyFormat`

The format of the body of the mail message. One of:

Option	Usage
<code>::MailMessage (kBodyFormatPlainText)</code>	<i>(Default)</i> The message body contains only ASCII characters and no formatting or disinformation.
<code>::MailMessage (kBodyFormatHtml)</code>	The message body contains HTML tags for formatting and display. An HTML message is identified by the MIME type <i>text/html</i> .
<code>::MailMessage (kBodyFormatRandom)</code>	Message bodies are a random mixture of plain and HTML format.

`bodySizeFixed`

If `bodySizeType` is set to `::MailMessage (kBodySizeTypeFixed)`, then this is the fixed size of the message body. (Default = 100).

`bodySizeRandomMax`



If `bodySizeType` is set to `$$::MailMessage(kBodySizeTypeRandom)`, then this is the maximum size of the message body. (Default = 4,096).

`bodySizeRandomMin`

If `bodySizeType` is set to `$$::MailMessage(kBodySizeTypeRandom)`, then this is the minimum size of the message body. (Default = 1).

`bodySizeType`

The manner in which the body size is specified. One of:

Option	Usage
<code>\$\$::MailMessage(kBodySizeTypeFixed)</code>	(Default) The size of the message body is fixed at a single size. Enter the size in the <i>bodySize</i> option.
<code>\$\$::MailMessagev(kBodySizeTypeRandom)</code>	The size of the message body varies ranbetween a minimum and a max- isize. Enter the minimum and maximum sizes in the <i>boand booptions</i> .

`custom_mail_body_use_real_file`

This option accepts boolean value of 0 or 1. If zero is given, there is no need to specify a file name. You have to enter the mail message text in `custom_mail_body_content`. If 1 is given, a file name is specified in the `custom_mail_body_filename`.

`custom_mail_body_encode`

This option specifies the encoding option for the real file. For boolean value 0, IxLoads encodes the file using the default encoding. For already encoded files, you choose boolean value 1.

`custom_mail_body_filename`

This option specifies the absolute path for the real file. For example: "c:\temp.txt" \

`custom_mail_body_content`

This option accepts the mail message text. For example: "abcd123."

`description`

A short textual description for the mail message. (Default = "100 bytes plain text body").

`headerList`

This is a list of type `Header`. The elements in this list are the headers associated with the mail message. (Default = an object with three items in the list: "From:fromName@company.com," "To:toName@company.com," "Subject:sample subject").

`name`

The name associated with this object. (Default = "Simple").

mail\_body\_type

The mail body type can be generated or custom data. You cannot import files through Tcl so you can work only with default or custom data. (Default = 1).

### EXAMPLE

```
set Simple [::IxLoad new MailMessage]$Simple config \-bodySizeType
0 \-name "Simple" \-fileNameAsBody
"" \-description "100 bytes plain text body" \-
textContentAsBody "" \-bodySizeRandomMax
4096 \-bodySizeFixed 100 \-mimeTypeAndEncode
0 \-bodySizeRandomMin 1 \-bodyDataType
0 \-useFileAsBody true \-bodyFormat
0$Simple headerList.clearset From [::IxLoad new MailHeader]$From config \-name
"From" \-value "fromName@company.com"$Simple head-
erList.appendItem -object $Fromset To [::IxLoad new MailHeader]$To config \-name
"To" \-value "toName@company.com"$Simple head-
erList.appendItem -object $Toset Subject [::IxLoad new MailHeader]$Subject config \-
name "Subject" \-value
"sample subject"$Simple headerList.appendItem -object $Subject$Simple attach-
mentList.clear$Activity_SMTPClient1 agent.mailMessageList.appendItem -object $Simple
```

### SEE ALSO

[SMTP Client Agent](#)

[Attachment](#)

[Header](#)

---

## SMTP Server Agent

SMTP Server Agent - configure an SMTP server

### SYNOPSIS

```
set Traffic2_Network2 [::IxLoad new ixNetTraffic]
set Activity_SMTPServer1 [$Traffic2_Network2 activityList.appendItem
$Activity_SMTPServer1 agent.config options...
```

### DESCRIPTION

An SMTP server agent is added to the `activityList` object. The `activityList` object is added to the `ixNetTraffic` object using the `appendItem` subcommand from the `ixConfigSequenceContainer` command.

Each member of the list, however may be separately addressed and modified using the `ixConfig` subcommands.

### SUBCOMMANDS

The options for this command are configured and read using the standard `config`, `cget`, and `getOptions` subcommands defined in the **ixConfig** command.

### OPTIONS

`concurrentSessionLimit`

The maximum number of concurrent sessions to be supported by the agent. (Default = 1,000).

`enable`

Enables the use of this action. (Default = true).

`name`

The name associated with this object, which must be set at object creation time.

`Server_Listening_Port`

Port that the SMTP server listens on. To specify multiple ports, separate the port numbers with commas (,). You can specify up to 50 listening ports. (Default = 25).

`enableVlanPriority`

VLAN Priority can be set on a per-activity basis or on a per-network (NetTraffic) basis. This parameter sets the VLAN priority for the activity. An activity's VLAN Priority bit setting takes precedence over a network's Priority bit setting. If `true`, IxLoad sets the VLAN Priority bit in traffic from this activity. Configure the VLAN priority value in `vlanPriority`. (Default = false).

`vlanPriority`

When *enableVlanPriority* is *true*, this option accepts the vlan priority value.

## STATISTICS

### EXAMPLE

```
set Traffic2_Network2 [::IxLoad new
ixNetTraffic]##### Activity SMTPServer1
of NetTraffic Traffic2@Network2#####set
Activity_SMTPServer1 [$Traffic2_Network2 activityList.appendItem \-protocolAndType
"SMTP Server" ]set _Match_Longest_ [::IxLoad new ixMatchLongestTimeline]$Activity_
SMTPServer1 config \-enable true \-name
"SMTPServer1" \-timeline $_Match_Longest_$Activity_
SMTPServer1 agent.config \-Server_Listening_Port "25" \-enable
true \-name "SMTPServer1" \-vlanPriority
0 \-concurrentSessionLimit 1000 \-enableVlanPriority
false
```

### SEE ALSO

ixNetTraffic

## SMTP Statistics

Statistics in the results files and reports are averaged over all ports. If a statistic for an interval is missing, IxLoad interpolates it from the statistic immediately prior to it and the statistic after it.

For TCP statistics, see [TCP, Run State, and Curve Segment Statistics](#).

The test results are available from the location defined on the User Directories window. See User Directories.

If you review your statistics and find many instances of SMTP Client statistics and server statistics that should match but do not, that may be an indication that the Ramp Down Time is too short. When the Ramp Down Time expires, IxLoad terminates any users that are still running. If those users still have work in progress (such as transferring data) when IxLoad terminates them, the work will not be completed and the effect will be that statistics that should match may not.

For the SMTP statistics, see the following:

[SMTP Client Statistics](#)

[SMTP Server Statistics](#)

## SMTP Client Statistics

The table below lists the statistics that IxLoad reports for SMTP clients.

Statistic	Description
SMTP Sessions Requested	Number of requests to establish SMTP sessions sent by the clients.
SMTP Sessions Established	Number of SMTP sessions established by the clients.
SMTP Sessions Failed	Number of attempts to establish SMTP sessions that failed.
SMTP Mails Sent	Number of mail messages sent by the clients using SMTP.
SMTP Messages Failed	Number of messages attempted to be sent using SMTP that failed.
SMTP Message Timeouts	Number of messages that could not be sent due to timeouts.
SMTP HELO Sent	Number of SMTP HELO commands sent.
SMTP HELO Ok	Number of SMTP HELO commands that received a positive response.
SMTP HELO Failed	Number of SMTP HELO commands that did not receive a positive response.
SMTP EHLO Sent	Number of SMTP EHLO commands sent.
SMTP EHLO Ok	Number of SMTP EHLO commands that received a positive response.
SMTP EHLO Failed	Number of SMTP EHLO commands that did not receive a positive response.
SMTP MAIL Sent	Number of SMTP MAIL commands sent.

SMTP MAIL Ok	Number of SMTP MAIL commands that received a positive response.
SMTP MAIL Failed	Number of SMTP MAIL commands that did not receive a positive response.
SMTP RCPT Sent	Number of SMTP RCPT commands sent.
SMTP RCPT Ok	Number of SMTP RCPT commands that received a positive response.
SMTP RCPT Failed	Number of SMTP RCPT commands that did not receive a positive response.
SMTP DATA Sent	Number of SMTP DATA commands sent.
SMTP DATA Ok	Number of SMTP DATA commands that received a positive response.
SMTP DATA Failed	Number of SMTP DATA commands that did not receive a positive response.
SMTP NOOP Sent	Number of SMTP NOOP commands sent.
SMTP NOOP Ok	Number of SMTP NOOP commands that received a positive response.
SMTP NOOP Failed	Number of SMTP NOOP commands that did not receive a positive response.
SMTP RSET Sent	Number of SMTP RSET commands sent.
SMTP RSET Ok	Number of SMTP RSET commands that received a positive response.
SMTP RSET Failed	Number of SMTP RSET commands that did not receive a positive response.
SMTP QUIT Sent	Number of SMTP QUIT commands sent.
SMTP QUIT Ok	Number of SMTP QUIT commands that received a positive response.

---

SMTP QUIT Failed	Number of SMTP QUIT commands that did not receive a positive response.
SMTP Total Bytes Sent	Total number of SMTP-related (commands, responses, and mail messages) bytes sent by the clients.
SMTP Total Bytes Received	Total number of SMTP-related (commands, responses, and mail messages) bytes received by the clients.
SMTP Total Attachments Sent	Total number of attachments sent by the clients.
SMTP Total Mails with Attachments Sent	Total number of messages sent that included one or more attachments.
SMTP Simulated Users	Number of simulated SMTP users.
SMTP Concurrent Connections	Number of concurrent SMTP connections maintained.
SMTP Connections	Number of SMTP connections established by the clients.
SMTP Transactions	Number of SMTP transactions completed by the clients. The SMTP client counts each SMTP command as one transaction. A successful transaction is an SMTP command for which an ACK is received. An unsuccessful transaction is one for which no ACK is received, or an error is received.
SMTP Bytes	Number of SMTP-related bytes sent and received by the clients.
SMTP Connection Rate	Rate at which the SMTP clients established connections to servers.
SMTP Transaction Rate	Rate at which the SMTP clients completed SMTP transactions.
SMTP Throughput	Rate at which the SMTP clients sent and received SMTP data.





**Note:** If the average table and bar graphs do not contain any data for the clients, that is an indication that they did not reach the Sustained (SU) run state. This can be caused by the following:

1. Stopping a test during the Ramp-Up phase.
2. Configuring a large number of page requests for the client agent so that not all the users configured for the client can attain the SU state within the allotted time.
3. Configuring a value for the statistics interval (Statistics tab) which is much larger than the SU time.

## SMTP Server Statistics

The table below lists the statistics that IxLoad reports for SMTP servers.

For TCP statistics, see [TCP, Run State, and Curve Segment Statistics](#).

Statistic	Description
SMTP Session Requests Received	Number of requests to establish SMTP sessions received by the servers.
SMTP Session Requests Successful	Number of SMTP sessions established by the servers.
SMTP Session Requests Failed	Number of requests to establish SMTP sessions that failed.
SMTP HELO Received	Number of SMTP HELO commands received.
SMTP EHLO Received	Number of SMTP EHLO commands received.
SMTP MAIL Received	Number of SMTP MAIL commands received.
SMTP RCPT Received	Number of SMTP RCPT commands received.
SMTP DATA Received	Number of SMTP DATA commands received.
SMTP NOOP Received	Number of SMTP NOOP commands received.
SMTP RSET Received	Number of SMTP RSET commands received.
SMTP QUIT Received	Number of SMTP QUIT commands received.
SMTP Mail Bytes Received	Number of bytes contained in SMTP mail messages received by the servers.
SMTP Mails Received	Number of mail messages received using SMTP. <b>NOTE for API Users:</b> There is a trailing space after the word 'Received' in the name of this statistic.
SMTP Total Bytes Sent	Number of SMTP-related bytes (commands, responses, and messages) sent.
SMTP Total Bytes Received	Number of SMTP-related bytes (commands, responses, and messages) received.

! 29

This page intentionally left blank.

# SSH

This section describes the SSH Tcl API objects.

## API Overview

The IxLoad SSH API consists of a client agent and its commands. The structure of the API is shown below.

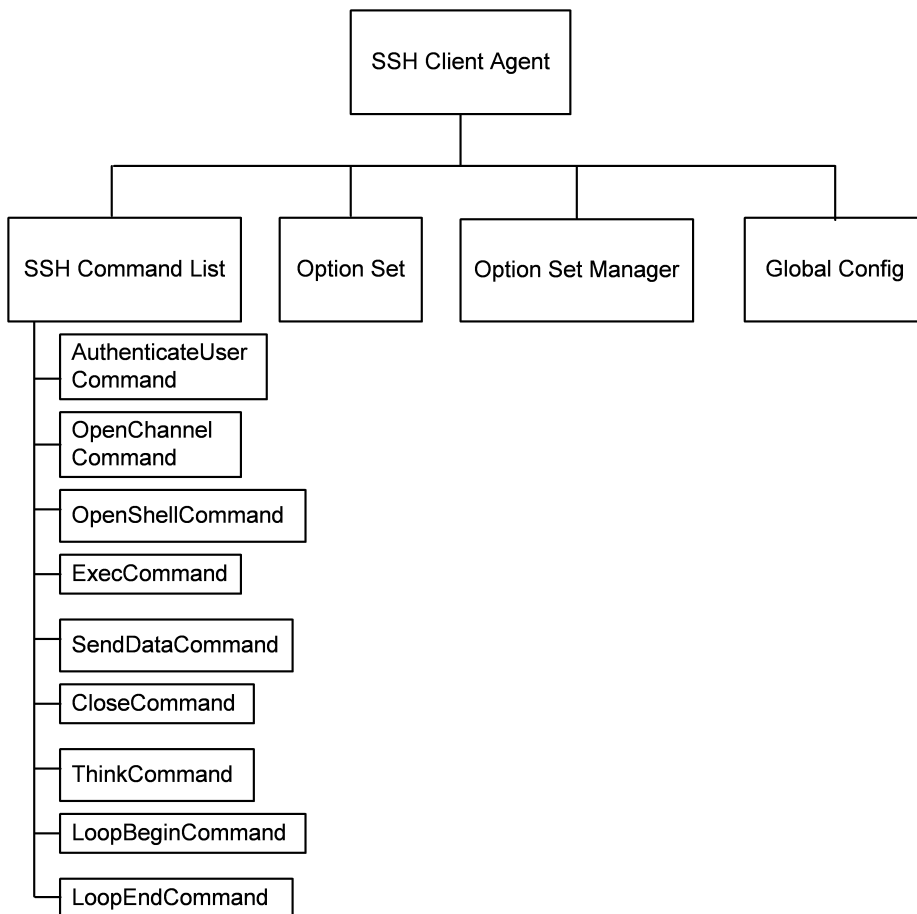

## Objectives

The objectives (userObjective) you can set for SSH are listed below. Test objecare set in the ixTimeline object.

- connectionRate
- transactionRate
- simulatedUsers
- concurrentConnections

## SSH Client Agent

Secure Shell (SSH) is a protocol for securely logging into a remote host over an insecure network. Refer to `SSH Client Agent` on page 24-4 for a full description of this command. The most significant options of this command are listed below.

Option	Description
<code>protocolAndType</code>	Protocol used by the client agent. Defines the agent as either a client or server.

## SSH Command List

The SSH Command List creates the list of SSH commands that the client will send to a SSH server. Refer to `SSH Command List` on page 24-10 for a full description of this command. The most significant options of this command are listed below.

Option	Description
<code>id</code>	Command that client will send.

## Option Set

The Option Set object configures the list of SSH options that the SSH commands will use. Refer to `Option Set` on page 24-15 for a full description of this com

## Option Set Manager

The Option Set Manager object configures the list of Option Sets. Refer to `Option Set Manager` on page 24-16 for a full description of this command.

## Global Config

Configures the parameters that define the way the IxLoad SSH client performs overall. Refer to `Global Config` on page 24-18 for a full description of this com

## SSH Client Agent

SSH Client Agent - create an SSH client

### SYNOPSIS

```
set Traffic1_Network1 [::IxLoad new ixNetTraffic]
set Activity_SSHClient1 [$Traffic1_Network1 activityList.appendItem \ options...
$Activity_SSHClient1 agent.config
```

### DESCRIPTION

A SSH client agent is added to the `activityList` option of the `ixNetTraffic` object using the `appendItem` subcommand from the `ixConfigSequenceContainer` `comOther` `ixConfigSequenceContainer` subcommands may be used to modify the `agentList`. It is customary to set all the options of the client agent during the `appendItem` call.

Each member of the list, however may be separately addressed and modified using the `ixConfig` subcommands.

### SUBCOMMANDS

The options for this command are configured and read using the standard `config`, `cget`, and `getOption` subcommands defined in the `ixConfig` command.

### OPTIONS

`enable`

Enables the use of this client agent. (Default = true).

`name`

The name associated with this object, which must be set at object creation time.

### STATISTICS

#### EXAMPLE

```
set Traffic1_Network1 [::IxLoad new ixNetTraffic]#-----
-----# Activity SSHClient1 of NetTraffic Traffic1@Network1#-----
-----set Activity_SSHClient1 [$Traffic1_Network1 activityList.appendItem \-protocolAndType "ssh
Client" ]$Activity_SSHClient1 agent.config \-enable
true \-name "SSHClient1"
```

### SEE ALSO

[ixNetTraffic](#)





## SSH Command List

SSH Command List—Creates the list of SSH commands that the client will send to a SSH server.

### SYNOPSIS

```
set Traffic1_Network1 [::IxLoad new ixNetTraffic]
$Activity_SSHClient1 agent.pm.commands.appendItem \ options...
```

### DESCRIPTION

A command is added to the SSH Command List object using the `appendItem` subcommand from the `ixConfigSequenceContainer` command (see the example below).

### SUBCOMMANDS

The options for this command are configured and read using the standard `config`, `cget`, and `getOption` subcommands defined in the `ixConfig` command.

### OPTIONS

`id`

DHCP command to be executed. One of the following:

Command	Description
AuthenticateUserCom	AuthenticateUserCommand simulates a key-based SSH user authentication session establishment and termination. It sends the following messages or commands: Key-Exchange-Init (SSH_MSG_KEXINIT) New-Keys (SSH_MSG_NEWKEYS) Service-Request (SSH_MSG_SERVICE_REQUEST) User-Authentication-Request (SSH_MSG_USERAUTH_REQUEST) {Close}

OpenChannelCom	<p>OpenChannelCommand performs a key-based SSH user authentication, establishes an SSH session, opens a new channel, and then terminates the session. It is a combination of an AuthenticateUserCommand, plus an OpenChannelComIt sends the following messages or commands:</p> <ul style="list-style-type: none"> <li>Key-Exchange-Init (SSH_MSG_KEXINIT)</li> <li>New-Keys (SSH_MSG_NEWKEYS)</li> <li>Service-Request (SSH_MSG_SERVICE_REQUEST)</li> <li>User-Authentication-Request (SSH_MSG_USERAUTH_REQUEST)</li> <li>Channel-Open (SSH_MSG_CHANNEL_OPEN)</li> </ul>
OpenShellCommand	<p>An OpenShellCommand requests that the server open a new channel and establish a new shell process. It is a combination of an OpenChannelCommand, plus a ChannelRequestComwith requestType set to "shell". It sends the following messages or commands:</p> <ul style="list-style-type: none"> <li>{OpenChannel}</li> <li>ChannelRequestCommand (SSH_MSG_CHANNEL_REQUEST) with requestType = shell</li> </ul>
ExecCommand	<p>An ExecCommand executes a command on the SSH server. It is a combination of an OpenChannelCommand, plus a Chanwith requestType set to "exec". It sends the following messages or commands:</p> <ul style="list-style-type: none"> <li>{OpenChannel}</li> <li>Channel-Request (SSH_MSG_CHANNEL_REQUEST) with Request Type = exec</li> </ul>
SendDataCommand	<p>A SendDataCommand sends data over the channel estabby a previous OpenChannelCommand.</p> <p>The maximum amount of data that can be sent, depends on the channel's maximum packet size or its current window size, whichever is smaller. Sending data decreases the remaining window size by the amount of data sent.</p> <p>{SendData} can send either of the following messages:</p> <ul style="list-style-type: none"> <li>Channel-Data (SSH_MSG_CHANNEL_DATA )</li> <li>Channel-Extended-Data (SSH_MSG_CHANNEL_EXTENDED_DATA)</li> </ul>
CloseCommand	<p>A CloseCommand terminates an SSH session. It sends the folmessages or commands:</p> <ul style="list-style-type: none"> <li>Channel-Close (if needed) (SSH_MSG_CHANNEL_CLOSE )</li> <li>Disconnect (SSH_MSG_DISCONNECT)</li> </ul>

ThinkCommand	<p>The THINKCommand causes the client to become idle for a specified length of time, to simulate real-world usage scenarios in which a user may spend time absorbing or processing information received from the server before sending the next command.</p> <p>If you specify identical values for the minimum and maximum intervals, the client will be inactive for a fixed length of time. If you specify different values for the minimum and maximum intervals, IxLoad will select a value within the range and cause the client to be inactive for that length of time.</p>
LoopBeginCommand	<p>The Loop BeginCommand is an IxLoad command that you can add to the Command List to cause the commands between it and the LoopEndCommand to be executed a specified number of times.</p>
LoopEndCommand	<p>LoopEndCommand ends the list of commands that will be executed by the preceding LoopBeginCommand.</p>

### Arguments for id = AuthenticateUserCommand

optionSet

Name of option set. A value for this argument must be one of the name objects from the optionSet object. Minimum length = 1. (Default = "Default Option Set").

userName

Name of simulated user to be authenticated.

password

The password required for the authentication.

authMethod

Method used to authenticate the user. You can select from the following method:

password: Password-based authentication

serverIPAddr

Address of the SSH server. (Default = "198.18.0.101").

### Arguments for id = OpenChannelCommand

serverIPAddr

Address of the SSH server. (Default = "198.18.0.101").

optionSet

Name of option set. A value for this argument must be one of the `name` objects from the `optionSet` object. Minimum length = 1. (Default = "Default Option Set").

`userName`

Name of simulated user to be authenticated.

`password`

The password required for the authentication.

`authMethod`

Method used to authenticate the user. You can select from the following method:

`password`: Password-based authentication

`initialWindowSize`

Initial size of the channel window, in bytes.

`maximumpacketSize`

Maximum size of the packets sent over the channel, in bytes.

### Arguments for `id = OpenShellCommand`

`serverIPAddr`

Address of the SSH server. (Default = "198.18.0.101").

`optionSet`

Name of option set. A value for this argument must be one of the `name` objects from the `optionSet` object. Minimum length = 1. (Default = "Default Option Set").

`userName`

Name of simulated user to be authenticated.

`password`

The password required for the authentication.

`authMethod`

Method used to authenticate the user. You can select from the following method:

`password`: Password-based authentication

`initialWindowSize`

Initial size of the channel window, in bytes.

`maximumpacketSize`

Maximum size of the packets sent over the channel, in bytes.

wantReply

If enabled, the server returns a message indicating the success or failure of the Channel-Request. The IxLoad client does not display the actual text of the response.

### Arguments for id = ExecCommand

serverIPAddr

Address of the SSH server. (Default = "198.18.0.101").

optionSet

Name of option set. A value for this argument must be one of the `name` objects from the `optionSet` object. Minimum length = 1. (Default = "Default Option Set").

userName

Name of simulated user to be authenticated.

password

The password required for the authentication.

authMethod

Method used to authenticate the user. You can select from the following methods:

password: Password-based authentication

initialWindowSize

Initial size of the channel window, in bytes.

maximumpacketSize

Maximum size of the packets sent over the channel, in bytes.

wantReply

If enabled, the server returns a message indicating the success or failure of the Channel-Request. The IxLoad client does not display the actual text of the response.

commandName

Name of the command to be executed on the server.

### Arguments for id = SendDataCommand

dataType

Type of data to be sent to the SSH server.

- `normalData`: Sends normal channel data.

- `extendedData`: Sends extended channel data. The only type of extended data available is `stderr` (`SSH_EXTENDED_DATA-STDERR`).

`fileName`

If data is imported from a file, then the path is mentioned here.

## Arguments for `id = CloseCommand`

`reasonCode`

Reason for ending the session. The values are:

Code	Description
1	<code>protocolError</code> Disconnecting because a protocol error occurred on the client or the server.
2	<code>keyExchangeFailed</code> Disconnecting because the key exchange failed on the client or server.
3	<code>macError</code> Disconnecting because the Message Authentication Code (MAC) failed on the client or server.
4	<code>compressionError</code> Disconnecting because a compression error occurred on the client or server.
5	<code>versionNotSupported</code> Disconnecting because the client or server does not support the protocol version indicated in the message.
6	<code>hostKeyNotVerifiable</code> Disconnecting because the host key could not be verified.
7	<code>connectionLost</code> Disconnecting because the connection was lost.
8	<code>disconnectByApplication</code> Disconnection caused by an application.
9	<code>tooManyConnections</code> Disconnected because the internal connection limit has been exceeded.

10	<b>noMoreAuthenticationMethodsAvailable</b> Disconnecting because there are no more authentication to try. This generally means that the client has failed in all the authenmethods available on the server.
----	---

#### description

Description of the reason for ending the session. The text must be in ISO-10646 UTF-8 encoding.

### Arguments for id = ThinkCommand

#### minimumInterval

Minimum length of time that the client is idle. Minimum = "1," maximum = "2,147,483,647." (Default = "1").

#### maximumInterval

Maximum length of time that the client is idle. Minimum = "1," maximum = "2,147,483,647." (Default = "1").

### Arguments for id = LoopBeginCommand

#### loopCount

Number of times to repeat the enclosed commands. '0' treated as infinity. Mini= "0," maximum = "2,147,483,647." (Default = "5").

### Arguments for id = LoopEndCommand

None.

### EXAMPLE

```
$Activity_SSHClient1 agent.pm.commands.appendItem \  
-id "AuthenticateUserCommand" \  
-userName "ixia-user" \  
-password "password" \  
-optionSet "Default Option Set" \  
-authMethod "password" \  
-serverIPAddr "198.18.0.101"
```

### SEE ALSO

[SSH Client Agent](#)



## Option Set

Options Set—Configures the algorithm and language preferences that the IxLoad SSH client sends with some commands that require or allow those preferences to be specified.

### SYNOPSIS

```
set Activity_SSHClient1 [$Traffic1_Network1 activityList.appendItem \
$Activity_SSHClient1 agent.pm.optionSet.config \ options...
```

### DESCRIPTION

An `Options Set` is a list of options, their arguments, and the commands for which those options are used. Configure the list using the same subcommands as for `ixConfig` (see the example below).

### SUBCOMMANDS

The options for this command are configured and read using the standard `config`, `cget`, and `getOption` subcommands defined in the `ixConfig` command.

### OPTIONS

`name`

Name of option set list. Minimum length = 1. (Default = "No Name")

`optionsList`

List of options and their arguments. See `Option Set Manager`. (Default = "{}").

`predefined`

If `true`, then the options in this option set are predefined for the SSH server to expose as available options. (Default = "0").

`inUse`

The option set that is configured through the `Option Set Manager`.. (Default = 0).

### EXAMPLE

```
$Activity_SSHClient1 agent.pm.optionSet.config \-predefined
false \-name "No Name" \-inUse
0
```

### SEE ALSO

[SSH Client Agent](#)

[Option Set Manager](#)

## Option Set Manager

Options Set Manager—Configures the list of Option Sets.

### SYNOPSIS

```
set Activity_SSHClient1 [$Traffic1_Network1 activityList.appendItem \
$Activity_SSHClient1 agent.pm.optionSetManager.optionSetList.appendItem \ options...
```

### DESCRIPTION

To configure an Option Set Manager, use the `appendItem` command on the `pm.optionSetManager` component of the `SSH Client Agent`.

### SUBCOMMANDS

None.

### OPTIONS

`id`

Key exchange algorithm to be used. Select an algorithms from the table below. Each algorithm takes arguments, which are also listed in the table.

Option/Arguments	Description
0 <code>kexAlgoName</code>	<code>kexAlgoElements</code> Algorithms that the IxLoad SSH client proposes to protect the exchange of public keys between itself and the SSH server.
1 <code>serverHostKeyAlgoName</code>	<code>serverHostKeyAlgoElements</code> Algorithms that the client offers to accept for generate the server's host key.
2 <code>encC2SAIgoName</code>	<code>encC2SAIgoElements</code> Algorithms that the client proposes to encrypt traffic it sends to the server.
3 <code>encS2CAIgoName</code>	<code>encS2CAIgoElements</code> Algorithms that the client offers to accept for encrypt traffic it receives from the server.
4 <code>macC2SAIgoName</code>	<code>macC2SAIgoElements</code> Algorithms that the client proposes for ensuring the integrity of data it sends to the server.

5 macS2CAIgoName	macS2CAIgoElements Algorithms that the client offers to accept for ensuring the integrity of data it receives from the server.
6 compC2SAIgoName	compC2SAIgoElements Algorithms that the client proposes for compressing the data it sends to the server.
7 compS2CAIgoName	compS2CAIgoElements Algorithms that the client offers to accept for compressing the data it receives from the server.
8 languageC2SName	C2SLanguageElements Languages that the client proposes for messages it sends to the server.
9 languageS2CName	S2CLanguageElements Languages that the client offers to accept for messages it receives from the server.

**EXAMPLE**

```

$Activity_SSHClient1 agent.pm.optionSetManager.optionSetList.appendItem \
-id "OptionSet" \
-predefined true \
-name "Default Option Set" \
-inUse 0
$Activity_SSHClient1 agent.pm.optionSetManager.optionSetList
(0).optionsList.clear$Activity_SSHClient1 agent.pm.optionSetManager.optionSetList
(0).optionsList.appendItem \
-id "KexAlgos"
$Activity_SSHClient1 agent.pm.optionSetManager.optionSetList(0).optionsList(0).kexAl-
goElements.clear$Activity_SSHClient1 agent.pm.optionSetManager.optionSetList(0).-
optionsList(0).kexAlgoElements.appendItem \
-id "KexAlgoElement" \
-kexAlgoName "diffie-hellman-group1-sha1"
$Activity_SSHClient1 agent.pm.optionSetManager.optionSetList.appendItem \
-id "OptionSet" \
-predefined 0 \
-name "Option Set - 0" \

```

SSH

---

-inUse 0

**SEE ALSO**

[Option Set](#)

## Global Config

Options Set Manager—Configures the parameters that define the way the IxLoad SSH client performs overall.

### SYNOPSIS

```
set Activity_SSHClient1 [$Traffic1_Network1 activityList.appendItem \
$Activity_SSHClient1 agent.pm.globalConfig.config \ options...
```

### DESCRIPTION

To configure the parameters that define the way the IxLoad SSH client performs overall. Use the `appendItem` command on the `pm.optionSetManager` component of the SSH Client Agent.

### SUBCOMMANDS

None.

### OPTIONS

`defaultSshPort`

The default Listening Port of an SSH Server. `minimum = "1" maximum = "65535" default = "22"`.

`timeout`

Amount of time an SSH Client will wait for getting a response from the Server. `minimum = "1" maximum = "2000" default = "600"`.

`defaultUserName`

The default user name used to login if no other user name is specified in authentication method configuration. `minimum = "1" maximum = "255" default = "ixia-user"`.

`password`

The password to be sent to the server for password authentication. `minimum = "1" maximum = "255" default = "password"`.

### EXAMPLE

```
$Activity_SSHClient1 agent.pm.globalConfig.config \-defaultSshPort
22 \-implicitLoopCheck true \-password
"password" \-defaultUserName "ixia-user" \-timeout
600
```

### SEE ALSO

[SSH Client Agent](#)

## SSH Client Statistics

The table below describes the SSH client statistics.

Statistic	Description
<b>Objective Statistics</b>	
<b>Simulated Users objective</b>	
User Count	If the objective is Simulated Users, this is the number of users created.
<b>Concurrent Sessions objective</b>	
SSH Concurrent Sessions	If the objective is Concurrent Sessions, this is the number of concurrent SSH sessions established.
<b>Transaction Rate objective</b>	
SSH Total Transactions	If the objective is Transaction Rate, this is the number of SSH transactions completed.
SSH Transaction Rate	If the objective is Transaction Rate, this is the rate at which the client completed SSH transactions.
<b>Connection Rate objective</b>	
SSH Connections Established	If the objective is Connection Rate, this is the number of SSH connections established.
SSH Connection Rate	If the objective is Connection Rate, this is the rate at which the client completed SSH transactions.
<b>Authentication Statistics</b>	
<b>User Authentication statistics</b>	
Total User Authentication Attempted	Total number of user authentication attempts of all types.
Total User Authentication Succeeded	Total number of user authentications of all types that succeeded.

Total User Authentication Failed	Total number of user authentications of all types that failed.
<b>NEWKEYS statistics</b>	
Total NEWKEYS Sent	Number of NEWKEYS messages sent by the client.
Total NEWKEYS Received	Number of NEWKEYS messages received by the client.
<b>KEXINIT statistics</b>	
Total KEXINIT Sent	Number of KEXINIT messages sent by the client.
Total KEXINIT Received	Number of KEXINIT messages received by the client.
<b>Service Request statistics</b>	
Total Service Request Sent	Total number of Service-Request messages sent by the client for all SSH protocols.
Total Service Accept Received	Number of Service-Accept messages received by the client.
Total Service Request Sent - SSH-Userauth	Number of Service-Request messages sent by the client for the SSH user authentication protocol (SSH-USERAUTH).
Total Service Request Sent - SSH-Connection	Number of Service-Request messages sent by the client for the SSH connection protocol (SSH-CONNECTION).
Total Service Accept Received - SSH-Userauth	Number of Service-Accept messages received for the SSH user authentication protocol (SSH-USERAUTH).
Total Service Accept Received - SSH-Connection	Number of Service-Accept messages received for the SSH connection protocol (SSH-CONNECTION).
Total Disconnect Received	Total number of Disconnect messages received for all SSH protocols.

Total Disconnect Received - SSH-Userauth	Number of Disconnect messages received for the SSH user authentication protocol (SSH-USERAUTH).
Total Disconnect Received - SSH-Connection	Number of Disconnect messages received for the SSH connection protocol (SSH-CONNECTION).
<b>Channel Request statistics</b>	
Total Channel Open Sent	Number of Channel Open messages sent by the client.
Total Channel Open Confirmation Received	Number of Channel Open confirmation messages received by the client.
Total Channel Open Failure Received	Number of Channel Open failure messages received by the client.
Total Channel Data Sent	Number of Channel Data messages sent by the client.
Total Channel Extended Data Sent	Number of Channel Data messages received by the client.
Total Channel Request Sent	Number of Channel-Request messages sent.
Total Channel Success Received	Number of Channel-Success messages sent.
Total Channel Failure Received	Number of Channel-Failure messages sent.
Total Channel EOF Sent	Number of Channel-EOF (End of File) messages sent.
Total Channel Close Sent	Number of Channel-Close messages sent.
Total Channel Request Sent - Shell	Number of shell-related Channel-Request messages sent.



Total Channel Request Sent - Exec	Number of exec-related Channel-Request messages sent.
Total Channel Success Received - Shell	Number of shell-related Channel-Success messages received.
Total Channel Success Received - Exec	Number of exec-related Channel-Success messages received.
Total Channel Failure Received - Shell	Number of shell-related Channel-Failure messages received.
Total Channel Failure Received - Exec	Number of exec-related Channel-Failure messages received.
Total Channel EOF Received	Total number of Channel-EOF messages received for all channels.
Total Channel Close Received	Total number of Channel-Close messages received for all channels.
<b>Request / Response statistics</b>	
Total Request Sent	Total number of requests of all kinds sent.
Total Response Received	Total number of responses of all kinds received.
Total Failure	Total number of failures of kinds that occurred.
<b>Throughput statistics</b>	
Total Bytes Sent	Total number of bytes sent in SSH messages.
Total Bytes Received	Total number of bytes received in SSH messages.
<b>Server Response Time statistics</b>	

Service Request Response Time	<p>Average time elapsed, in ms, between the time the client sent a Service-Request message and the time it received a Service-Accept or Disconnect message in response.</p> <p>Note for Tcl API users: This is a weighted statistic. If you are using this statistic in a Tcl script, use the <i>kWeightedAverage</i> aggregation type.</p>
Userauth Request Response Time	<p>Average time elapsed, in ms, between the time the client sent a UserAuth-Request message and the time it received a UserAuth-Success or UserAuth-Failure message in response.</p> <p>Note for Tcl API users: This is a weighted statistic. If you are using this statistic in a Tcl script, use the <i>kWeightedAverage</i> aggregation type.</p>
Channel Open Request Response Time	<p>Average time elapsed, in ms, between the time the client sent a Channel-Open-Request message and the time it received a Channel-Open-Confirmation or Channel-Open-Failure message in response.</p> <p>Note for Tcl API users: This is a weighted statistic. If you are using this statistic in a Tcl script, use the <i>kWeightedAverage</i> aggregation type.</p>
Channel Request Response Time	<p>Average time elapsed, in ms, between the time the client sent a Channel-Request message and the time it received a Channel-Success or Channel-Failure message in response.</p> <p>Note for Tcl API users: This is a weighted statistic. If you are using this statistic in a Tcl script, use the <i>kWeightedAverage</i> aggregation type.</p>
NewKeys Response Time	<p>Average time elapsed, in ms, between the time the client sent a KEXINIT message and the time it received a NEWKEYS message in response.</p> <p>Note for Tcl API users: This is a weighted statistic. If you are using this statistic in a Tcl script, use the <i>kWeightedAverage</i> aggregation type.</p>

# Stateless Peer

This section describes the Stateless Peer Tcl API objects.

## Stateless Peer Overview

The Stateless Peer API consists of the Stateless Peer Agent and its commands.

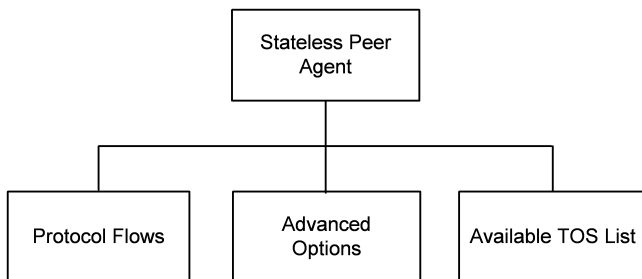

## Objectives

The objectives (userObjective) you can set for the Stateless Peer are listed below. Test objectives are set in the ixTimeline object.

- simulatedUsers
- peerCount (displays as Initiator Peer Count in the GUI)
- connectionRate
- concurrentConnections
- throughputMbps
- throughputKbps
- throughputGbps
- transactionRate

## Stateless Peer Commands

This section lists the Application Replay Peer's commands.

---

## Stateless Peer Agent

Stateless Peer Agent - create a Stateless Peer agent

### SYNOPSIS

### DESCRIPTION

A Stateless Peer agent is added to the `activityList` object. The `activityList` object is added to the `ixNetTraffic` object using the `addItem` subcommand from the `ixConfigSequenceContainer` command.

### SUBCOMMANDS

The options for this command are configured and read using the standard `config`, `cget`, and `getOption` subcommands defined in the `ixConfig` command.

### OPTIONS

`enable`

Enables the use of this client agent. (Default = `true`).

`name`

The name associated with this object, which must be set at object creation time.

`userIpMapping`

Mapping between IP address usage and simulated users. Default = `"1:1"`

`enableConstraint`

If `true`, the `constraintValue` is applied. Default = `false`

`userObjectiveValue`

User objective value. Default = `100`

`constraintValue`

If `enableConstraint` is `true`, this option specifies the constraint that is applied. Default = `100`

`userObjectiveType`

Objective of the activity. Default = `"peerCount"`

`timeline`

Name of the timeline used for this activity. Default = `$Timeline1`

## STATISTICS

### EXAMPLE

```
set Activity_StatelessPeer1 [$myNetTraffic activityList.appendItem \  
-protocolAndType          "stateless Peer" ]
```

```
set Timeline1 [::IxLoad new ixTimeline]
```

```
$Timeline1 config \  

```

```
-rampUpValue          1 \  
-offlineTime          0 \  
-rampDownTime         20 \  
-name                 "Timeline1" \  
-rampUpInterval       1 \  
-sustainTime          20 \  
-standbyTime          0 \  
-timelineType         0 \  
-rampUpType           0
```

```
$Activity_StatelessPeer1 config \  

```

```
-enable              true \  
-name               "StatelessPeer1" \  
-userIpMapping      "1:1" \  
-enableConstraint   false \  
-userObjectiveValue 100 \  
-constraintValue    100 \  
-userObjectiveType  "peerCount" \  
-timeline           $Timeline1
```

### SEE ALSO

ixNetTraffic



## Stateless Peer Advanced Options

Advanced Options - configure the Stateless Peer's global options

### SYNOPSIS

### DESCRIPTION

The Advanced Options object configures the Stateless Peer's global options.

### SUBCOMMANDS

None.

### OPTIONS

`enableTOS`

If `true`, TOS bits are included in packets from this activity. Default = `false`.

`typeOfService`

If `enableTOS` is `true`, this option configure the TOS bit used. Default = `"Best Effort (0x0)"`

`parallelCmdCnt`

Number of commands to execute simultaneously. Default = `1`.

### STATISTICS

### EXAMPLE

```
$Activity_StatelessPeer1 agent.pm.advOptions.config \  
-enableTOSfalse \  
-typeOfService"Best Effort (0x0)" \  
-parallelCmdCnt1
```

### SEE ALSO



## Stateless Peer Protocol Flows

Protocol Flows - configure the Stateless Peer's commands

### SYNOPSIS

```
$Activity_StatelessPeer1 agent.pm.protocolFlows.appendItem \  
-id"LoopBeginCommand" \  
-LoopCount5
```

### DESCRIPTION

An option is added to the list of protocol flows using the `appendItem` subcommand from the `ixConfigSequenceContainer` command.

### SUBCOMMANDS

None.

### OPTIONS

#### Options for LoopBeginCommand

`id`

Name of the command to be executed. Default = "LoopBeginCommand".

`LoopCount`

Number of times to execute the loop. Default = 5.

#### Options for GenerateStream

`id`

Name of the command to be executed . Default = "GenerateStream"

`remotePeer`

Name of the Stateless Peer that is the destination of the traffic. Default = "".

`destination`

Destination of traffic from this initiator. Default = "None".

- If the destination is a DUT, specify its IP address.
- If the destination is another Stateless Peer activity, specify its name.

`minPacketFreq`

Minimum rate at which packets will be sent. Default = 100.

`maxpacketFreq`

Maximum rate at which packets will be sent. Default = 100.

`streamDur`

Length of time, in seconds, to transmit the stream. Default = 20.

`destinationPort`

Port number on destination Stateless Peer to which traffic is sent. This can be a single port or a range (for example: 1024-2048). Default = 0.

`sourcePort`

Port number on the source Stateless Peer to which traffic is sent. Default = 0.

`minContentSize`

Minimum size of the IP payload. Default = 1024.

`maxContentSize`

Maximum size of the IP payload. Default = 1024.

### Options for GenerateIPStream

`id`

Name of the command to be executed . Default = "GenerateIPStream".

`remotePeer`

Name of the Stateless Peer that is the destination of the traffic. Default = "None".

`proto`

Protocol ID contained in traffic from the peer. The list of protocol IDs is at <http://www.iana.org/assignments/protocol-numbers/>. Default = 0.

`streamDur`

Length of time, in seconds, to transmit the stream. Default = 20.

`minPacketFreq`

Minimum rate at which packets will be sent. Default = 100.

`maxpacketFreq`

Maximum rate at which packets will be sent. Default = 100.

`minContentSize`

Minimum size of the IP payload. Default = 1024.

`maxContentSize`

Maximum size of the IP payload. Default = 1024.

### Options for LoopEndCommand

id

Name of the command to be executed . Default = "LoopEndCommand".

### Options for Think

id

Name of the command to be executed . Default = "Think".

minimumInterval

Minimum length of time to think for. Default = 1000.

minimumInterval

Maximum length of time to think for. Default = 1000.

## STATISTICS

### EXAMPLE

```
$Activity_StatelessPeer1 agent.pm.protocolFlows.clear
```

```
$Activity_StatelessPeer1 agent.pm.protocolFlows.appendItem \  
-id"LoopBeginCommand" \  
-LoopCount5
```

```
$Activity_StatelessPeer1 agent.pm.protocolFlows.appendItem \  
-id"GenerateStream" \  
-remotePeer"None" \  
-packetFreq100 \  
-streamDur20 \  
-destinationPort23 \  
-sourcePort22 \  
-contentSize1024
```

```
$Activity_StatelessPeer1 agent.pm.protocolFlows(1).payloadHeaderList.clear
```

```
$Activity_StatelessPeer1 agent.pm.protocolFlows(1).payloadHeaderList.appendItem \  
-id"payloadHeaderRow" \  
-streamIdentifierfalse \  
-length1 \  
-type1 \  
-value"255"
```

```
$Activity_StatelessPeer1 agent.pm.protocolFlows.appendItem \  
-id"LoopEndCommand"
```

```
$Activity_StatelessPeer1 agent.pm.protocolFlows.appendItem \  
-id"Think" \  
-minimumInterval1000 \  
-maximumInterval1000
```

### SEE ALSO

### Stateless Peer Payload Header List

Protocol Header List - list of headers in the UDP packets.

### SYNOPSIS

```
$Activity_StatelessPeer1 agent.pm.protocolFlows(1).payloadHeaderList.appendItem \  
-id"payloadHeaderRow" \  
-streamIdentifierfalse \  
-length1 \  
-type1 \  
-value"255"
```

## DESCRIPTION

`payloadHeaderList` defines the list of headers in the UDP packet. This list is of type `ixConfigSequenceContainer`; items are added to the list via the `appendItem` sub-command. (Default = {}).

```
$Activity_StatelessPeer1 agent.pm.protocolFlows(1).payloadHeaderList.appendItem
```

Before you add items to the list, you should clear it. For example:

```
$Activity_StatelessPeer1 agent.pm.protocolFlows(1).payloadHeaderList.clear
```

## SUBCOMMANDS

None.

## OPTIONS

`id`

Name of the header. Default = "payloadHeaderRow".

`streamIdentifier`

A boolean that indicates whether or not this header is used to identify the stream. At least one header row must have this flag set. Default = false.

`length`

length of the data in the `value` field. Min = 1, Max = 65535, Default = 1.

`type`

Type of the data in the `value` field. Default = 1. The choices are:

Choice	Description
1	1 byte
2	2 bytes
3	3 bytes
4	4 bytes
5	Fixed binary
6	Fixed ascii

`value`

Value of the header field. Default = "".

## STATISTICS

### EXAMPLE

```
$Activity_StatelessPeer1 agent.pm.protocolFlows(1).payloadHeaderList.clear
```

```
$Activity_StatelessPeer1 agent.pm.protocolFlows(1).payloadHeaderList.appendItem \  
-id"payloadHeaderRow" \  
-streamIdentifierfalse \  
-length1 \  
-type1 \  
-value"255"
```

### SEE ALSO

#### Stateless Peer Available TOS List

Available TOS List - list of TOS values in the UDP packets.

### SYNOPSIS

```
$Activity_StatelessPeer1 agent.pm.availableTosList.appendItem \  
-id"AvailableTypeOfService" \  
-tos_value"Best Effort (0x0)"
```

### DESCRIPTION

`availableTosList` defines the list of TOS values in the UDP packet. This list is of type `ixConfigSequenceContainer`; items are added to the list via the `appendItem` sub-command. (Default = {}).

```
$Activity_StatelessPeer1 agent.pm.availableTosList.appendItem
```

Before you add items to the list, you should clear it. For example:

```
$Activity_StatelessPeer1 agent.pm.availableTosList.clear
```

### SUBCOMMANDS

None.

## OPTIONS

id

Name of the TOS value. Default = "AvailableTypeOfService".

tos\_value

TOS value. The possible TOS values are listed below. Default = "".

"Best Effort (0x0)"

"Class 1 (0x20)"

"Class 2 (0x40)"

"Class 3 (0x60)"

"Class 4 (0x80)"

"Express Forwarding (0xA0)"

"Control (0xC0)"

## STATISTICS

### EXAMPLE

```
$Activity_StatelessPeer1 agent.pm.availableTosList.clear
```

```
$Activity_StatelessPeer1 agent.pm.availableTosList.appendItem \  
-id"AvailableTypeOfService" \  
-tos_value"Best Effort (0x0)"
```

### SEE ALSO

! 31

This page intentionally left blank.



# HTTP Streaming

This section describes the Streaming Client Tcl API objects.

## API Overview

The IxLoad Streaming Client API consists of the Streaming Client Agent, and its commands.

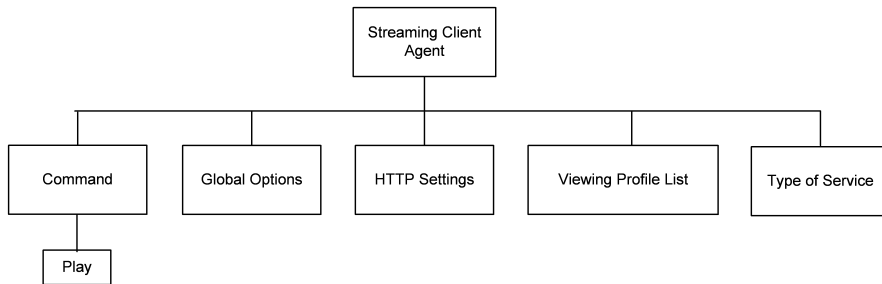

## Objectives

The objectives (userObjective) you can set for Streaming Clients are listed below. Test objectives are set in the ixTimeline object.

- simulatedUsers

## HTTP Streaming Client Agent

Streaming client agent - create a Streaming client agent

### SYNOPSIS

```
set Activity_StreamingClient1 [$Traffic1_Network1 activityList.appendItem \  
-protocolAndType          "Streaming Client" ]
```

### DESCRIPTION

A Streaming client agent is added to the activityList object. The activityList object is added to the ixNetTraffic object using the appendItem subcommand from the ixConfigSequenceContainer command.

### SUBCOMMANDS

None.

### OPTIONS

The options for this command are configured and read using the standard `config`, `cget`, and `getOption` subcommands defined in the `ixConfig` command.

### STATISTICS

### EXAMPLE

```
set Activity_StreamingClient1 [$Traffic1_Network1 activityList.appendItem \  
-protocolAndType          "Streaming Client" ]
```

### SEE ALSO

`ixNetTraffic`

## cmdList

cmdList - configure the list of commands that the Streaming client executes.

### SYNOPSIS

```
$Activity_StreamingClient1 agent.pm.cmdList.appendItem \
```

### DESCRIPTION

The cmdList object configures the list of commands that the Streaming client executes.

To add a command to the list, you use the `appendItem` subcommand from the `ixConfigSequenceContainer` command. Other `ixConfigSequenceContainer` subcommands may be used to modify the command list. It is customary to set all the options of the command list during the `appendItem` call.

Each member of the list can be separately addressed and modified using the `ixConfig` subcommands.

Before you add items to the command list, you should initialize the list by using the `clear` subcommand of the `ixConfigSequenceContainer` command.

### SUBCOMMANDS

### OPTIONS

See individual commands.

### EXAMPLE

```
$Activity_StreamingClient1 agent.pm.cmdList.clear
```

```
$Activity_StreamingClient1 agent.pm.cmdList.appendItem \
-minimumInterval          10 \
-durationType             0 \
-maximumInterval          10 \
-mediaUrl                 "" \
-cmdName                  "PLAY 4" \
-commandType              "Play" \
-serverAddr               ""
```

**SEE ALSO**

## Global options

Streaming client global config - configure the global properties of a streaming client agent

### SYNOPSIS

```
$Activity_StreamingClient1 agent.pm.globalOptions.config
```

### DESCRIPTION

This object configures the global properties of a Streaming client agent.

### SUBCOMMANDS

None.

### OPTIONS

`protocol`

Streaming protocol.

Values	Description
0 (default)	HTTP Live Streaming (HLS)"
1	Silverlight Streaming

`enableTos`

Enables setting of TOS bits.

Default = 0

`tosValue`

Enables setting of TOS bits. Must be one of the settings defined in the [availableTosList](#).

Default = "Best Effort (0x0)"

`enableEsm`

Enable sending of the MSS size.

Default = 0

`esm`

MSS size.

Min = 64, max = 1460, default = 1460

`enableVlanPriority`

Enables setting of the VLAN priority.

Default = 0

`vlanPriority`

VLAN priority.

Min = 0, max = 7, default = 0

`enableUserMonitoring`

Enables monitoring of a specific user.

Default = 0

`monitorUserId`

ID of the user to monitor.

Default = 0

`bufferingType`

Buffering scheme used.

Values	Description
0 (default)	Infinite
1	Finite

`bufferValue`

Size (in seconds) of the buffer for finite buffers.

Min = 1, Default = 30

**EXAMPLE**

```
$Activity_StreamingClient1 agent.pm.globalOptions.config \
```

```
-enableTos           false \
-enableEsm           false \
-protocol            0 \
-vlanPriority        0 \
-monitorUserId       0 \
-bufferValue         30 \
-tosValue            "Best Effort (0x0)" \
```

```
-enableUserMonitoring      false \  
-bufferingType             0 \  
-esm                       1460 \  
-enableVlanPriority        false
```

**SEE ALSO**

[ixNetTraffic](#)

## HTTP settings

Streaming client HTTP settings - configure the HTTP properties of a streaming client agent

### SYNOPSIS

```
$Activity_StreamingClient1 agent.pm.httpSettings.config
```

### DESCRIPTION

This object configures the HTTP properties of a Streaming client agent.

### SUBCOMMANDS

None.

### OPTIONS

`httpVersion`

HTTP version.

Value	Description
0	HTTP 1.0
1 (default)	HTTP 1.1

`httpKeepalive`

Enables HTTP keep alive.

Default = 0

`enableTransactionsPerConnection`

Enables multiple transactions per HTTP connection.

Value	Description
0 (default)	Maximum possible
1	Up to number specified in <code>httpTransactionsPerConnection</code>

`httpTransactionsPerConnection`

Number of transactions per HTTP connection.

Min = 1, default = 1

`enableProxy`



Enables use of an HTTP proxy.

Default = 0

`proxyIP`

HTTP proxy host name or IP address. Maximum length = 255.

Default = 0.0.0.0

`proxyTCPPort`

HTTP proxy listening port.

Default = 80

`playerEmulation`

Type of player emulated by Streaming client.

Value	Description
0 (default)	Safari

## EXAMPLE

```
$Activity_StreamingClient1 agent.pm.httpSettings.config \
```

```
-enableProxy          false \  
-enableTransactionsPerConnection 0 \  
-proxyTCPPort         "80" \  
-httpTransactionsPerConnection 1 \  
-playerEmulation      0 \  
-httpKeepalive        false \  
-proxyIP              "0.0.0.0" \  
-httpVersion          1
```

## SEE ALSO

`ixNetTraffic`

## availableTosList

availableTosList - configure the list of ToS levels for a Streaming client.

### SYNOPSIS

```
$Activity_StreamingClient1 agent.pm.availableTosList.appendItem \  
-id "AvailableTypeOfService" \  
-tos_value "Best Effort (0x0)"
```

### DESCRIPTION

The `availableTosList` object configures the list of available ToS levels.

To add a ToS level to the list, you use the `appendItem` subcommand from the `ixConfigSequenceContainer` command. Other `ixConfigSequenceContainer` subcommands may be used to modify the `availableTosList`. It is customary to set all the options of the `availableTosList` during the `appendItem` call.

Each member of the list can be separately addressed and modified using the `ixConfig` subcommands.

Before you add items to the `availableTosList`, you should initialize the list by using the `clear` subcommand of the `ixConfigSequenceContainer` command.

### SUBCOMMANDS

#### OPTIONS

`id`

ToS list name. (Default = "AvailableTypeOfService").

`tos_value`

ToS level to be added to the list. Default = "" (null).

Choices:

"Best Effort (0x0)"

"Class 1 (0x20)"

"Class 2 (0x40)"

"Class 3 (0x60)"

"Class 4 (0x80)"

"Express Forwarding (0xA0)"

"Control (0xC0)"

## **STATISTICS**

### **EXAMPLE**

```
$Activity_StreamingClient1 agent.pm.availableTosList.appendItem \  
-id "AvailableTypeOfService" \  
-tos_value "Best Effort (0x0)"
```

### **SEE ALSO**

## Streaming Client Statistics

This section lists the statistics for HTTP Streaming Clients.

The test results are available from the location defined on the User Directories window. See User Directories.

For TCP statistics, see [TCP, Run State, and Curve Segment Statistics](#).

### HTTP Statistics

The table below lists the HTTP statistics for clients.

Statistic	Description
HTTP Bytes	Amount of HTTP data sent and received by the clients, in bytes.
HTTP Bytes Received	Number of HTTP bytes received by the clients. If you probe the network link with a sniffer, this statistic is not the same as the total amount of TCP payload that appears on the link. The total amount of TCP payload can be greater than this statistic due to increases caused by retransmits. SSL-encrypted payload data is included in this statistic but SSL handshake overhead is not (HTTP only).
HTTP Bytes Sent	Number of HTTP bytes transmitted by the clients. If you probe the network link with a sniffer, this statistic is not the same as the total amount of TCP payload that appears on the link. The total amount of TCP payload can be greater than this statistic (increased by retransmits) or less than this statistic (decreased by broken or reset connections). SSL-encrypted payload data is included in this statistic but SSL handshake overhead is not (HTTP only).
HTTP Connect Time (us)	Average time elapsed between the time the client sends a SYN packet and the time it receives the SYN/ACK.
HTTP Connection Attempt Rate	Rate at which the client attempted to establish HTTP connections.
HTTP Connection Attempts	Total number of connections attempted.

HTTP Connection Rate	Rate at which the client established HTTP connections.
HTTP Connections	Total number of connections established by the clients.
HTTP Content Bytes Received	Number of bytes of HTTP data received.
HTTP Content Bytes Sent	Number of bytes of HTTP data sent.
HTTP Intermediate Responses Received (1xx)	Number of 100-series (Informational) responses received. 100-series responses indicate a provisional response, consisting only of the Status-Line and optional headers, and terminated by an empty line. Refer to RFC 2616, Section 10, for a full description.
HTTP Requests Failed	Number of HTTP requests that failed for any reason. The statistics show the number of requests for each URL (page).
HTTP Requests Failed (400)	Bad Request. Number of requests that failed due to a syntax error in the URL. The statistics show the number of requests for each URL (page).
HTTP Requests Failed (401)	Unauthorized. Number of requests that failed due to because the server did not receive the correct user name or password from the browser. The statistics show the number of requests for each URL (page).
HTTP Requests Failed (403)	Forbidden. Number of requests that failed due to because the name or password supplied by the browser are incorrect. The statistics show the number of requests for each URL (page).
HTTP Requests Failed (404)	Not Found. Number of requests that failed because requested object is not stored on the server on the path supplied. The statistics show the number of requests for each URL (page).
HTTP Requests Failed (407)	Proxy Authentication Required. Number of requests that failed because access to the URL requires authentication with a proxy server.
HTTP Requests Failed (408)	Timeout. Number of requests that failed due to communications between the client and server taking too long. The statistics show the number of requests for each URL (page).

HTTP Request Pre-condition Failed (412)	The precondition given in one or more of the request-header fields evaluated to false when it was tested on the server. This response code allows the client to place pre-conditions on the current resource metainformation (header field data) and thus prevent the requested method from being applied to a resource other than the one intended.
HTTP Requests Failed (4xx other)	Number of HTTP requests that failed for reasons other than a Bad Request (400), Unauthorized (401), Forbidden (403), Not Found (404), Proxy Authentication Required (407), or Timeout (408) error. The statistics show the number of requests for each URL (page).
HTTP Requests Failed (4xx)	Number of 4xx-range responses received by the clients in response to an HTTP request. The statistics show the number of requests for each URL (page). 408 responses are counted separately by the HTTP Session Timeout (408) statistic and may or may not also be included in the HTTP Requests Failed (4xx) count. See the description of HTTP Session Timeout (408) for more information.
HTTP Requests Failed (505)	HTTP Version not Supported. Number of requests that failed because the server does not support the HTTP version used by the client. The statistics show the number of requests for each URL (page).
HTTP Requests Failed (5xx other)	Number of requests that failed for reasons other than an HTTP version mis-match (505). The statistics show the number of requests for each URL (page).
HTTP Requests Failed (5xx)	Number of HTTP requests that failed due to lack of resources on the server (HTTP 500-series errors). This statistic is only incremented if the client had issued a request to the server before receiving the 5xx response. The statistics show the number of requests for each URL (page).
HTTP Requests Failed (Aborted)	Number of HTTP requests that ended prematurely due to events outside HTTP or TCP. For example, if any HTTP requests are pending when the Ramp-Down period ends, those requests are aborted by IxLoad. The statistics show the number of requests for each URL (page).
HTTP Requests Failed (Bad Header)	Number of HTTP requests that failed due to a defective HTTP header. The statistics show the number of requests for each URL (page).
HTTP Requests Failed (other)	Number of requests that failed that could not be classified.

HTTP Requests Failed (Read)	Number of HTTP requests that failed due to a socket read error. The statistics show the number of requests for each URL (page).
HTTP Requests Failed (Timeout)	Number of HTTP requests that failed because the clients did not receive a response within 600 seconds. The statistics show the number of requests for each URL (page).
HTTP Requests Failed (Write)	Number of HTTP requests that failed due to a socket write error. The statistics show the number of requests for each URL (page).
HTTP Requests Sent	Number of HTTP requests sent by the clients. The statistics show the number of requests for each URL.
HTTP Requests Successful	Number of positive HTTP responses (2xx- and 3xx-range responses) received by the clients. The statistics show the number of requests for each URL.
HTTP Requests Successful (2xx)	Number of 200-series (Successful) responses received. 200-series responses indicate that the client's request was successfully received, understood, and accepted.
HTTP Requests Successful (301)	Number of 301 (Moved Permanently) responses received. 301 responses indicate that the requested resource has been assigned a new permanent URI and any future references to this resource should use one of the returned URIs.
HTTP Requests Successful (302)	Number of 302 (Found) responses received. 302 responses indicate that the requested resource resides temporarily under a different URI.
HTTP Requests Successful (303)	Number of 303 (See Other) responses received. 303 responses indicate that the response to the request can be found under a different URI and should be retrieved using a GET method on that resource.

HTTP Requests Successful (307)	Number of 307 (Temporary Redirect) responses received. 307 responses indicate that the requested resource resides temporarily under a different URI.
HTTP Requests Successful (3xx)	Number of 300-series (Redirection) responses received. 300-series responses indicate that further action needs to be taken by the user agent in order to fulfill the request.
HTTP Session Timeouts (408)	Number of HTTP 408 responses received. This statistic includes all 408 responses received regardless of whether they were received for a pending HTTP request or not. IxLoad counts 408 responses differently depending on whether or not a client has a pending HTTP request: <ul style="list-style-type: none"> <li>If a client has an HTTP request pending and it receives a 408 response, IxLoad increments the HTTP Received 408, HTTP Requests Failed (4xx), and HTTP Requests Failed statistics.</li> </ul> If a client does not have an HTTP request pending and it receives a 408 response, IxLoad only increments the HTTP Received 408 statistic.
HTTP Sessions Rejected (503)	Service Unavailable. Number of HTTP sessions that could not be established due to lack of resources on the server.
HTTP Throughput	Rate at which the client sent and received HTTP traffic.
HTTP Time To First Byte (us)	Average time elapsed before clients received the first byte of an HTTP response.
HTTP Time To Last Byte (us)	Average time elapsed before clients received the last byte of an HTTP response.
HTTP Transaction Rate	Rate at which the client completed HTTP transactions.
HTTP Transactions	Total number of transactions completed by the clients.
HTTP Transactions Active	Number of HTTP transactions transferring HTTP commands or data.



! 32

This page intentionally left blank.

# Telnet

This section describes the Telnet Tcl API objects.

## API Overview

Telnet protocol commands are organized as a simple structure.

- Telnet Client Agent
- Telnet Client Basic Options
- Telnet Client Advanced Options
- Telnet Client Command
- Telnet Server Agent
- Telnet Server Agent
- Telnet Server Basic Options
- Telnet Server Advanced Options

## Objectives

The objectives (userObjective) you can set for Telnet are listed below. Test objectives are set in the ixTimeline object.

- connectionRate
- transactionRate
- simulatedUsers
- concurrentConnections

## Telnet Client Agent

The Telnet Client Agent defines a client performing Telnet commands. Refer to `Telnet Client Agent` for a full description of this command.

The important options and subobjects of this command are listed below.

Option	Usage
enable	Enables the use of the Telnet client agent.
name	The name associated with the client agent.

Option	Usage
basic	Basic Telnet client options, as described in <code>- Telnet Client Basic Options</code> .
advanced	Advanced Telnet client options, as described in <code>- Telnet Client Advanced Options</code>
commands	A list of Telnet commands to be executed, as described in <code>- Telnet Client Command</code> .

### Telnet Client Basic Options

This object holds the basic options associated with a Telnet client. Refer to `Telnet Client Basic Options` for a full description of this command. The important options of this command are listed below.

Option	Usage
expectTimeout	Time to wait for any command to complete.
commandPrompt	The default value of the command prompt.
enableOptions	Enables option negotiation.

### Telnet Client Advanced Options

The Telnet client advanced options control network level operation of the client. Refer to `Telnet Client Advanced Options` for a full description of this command. The important options of this command are listed below.

Option	Usage
enableEsm	Enable the use of ESM.
esm	The ESM value.

## Telnet Client Command

The Telnet command object specifies a single Telnet command to be executed by the client. Refer to `Telnet Client Command` for a full description of this command. The important options of this command are listed below.

Command Option	Related Option	Usage
id = OpenCommand	serverIP	The IP name or address of the Telnet server to login to.
	expect	The string to wait for after sending the command(s).
id = LoginCommand	send	The user name to send.
	expect	The string to wait for after sending the command.
id = PasswordCommand	send	The password to send.
	expect	The string to wait for after sending the command.
id = SendCommand	send	A string to be sent.
	expect	The string to wait for after sending the command.
id = ThinkCommand	minimumInterval	The sleep min value.
	maximumInterval	The sleep max value.
id = Exit	send	The string to be sent to end the session.

## Telnet Server Agent

The Telnet Server Agent defines a server performing Telnet commands. Refer to `Telnet Server Agent` for a full description of this command. The important options and subobjects of this command are listed below.

Option	Usage
<code>enable</code>	Enables the use of the Telnet server agent.
<code>name</code>	The name associated with the server agent.

Option	Usage
<code>basic</code>	Basic Telnet server options, as described in - <code>Telnet Server Basic Options</code> .
<code>advanced</code>	Advanced Telnet server options, as described in - <code>Telnet Server Advanced Options</code>

## Telnet Server Basic Options

This object holds the basic options associated with a Telnet server. Refer to `Telnet Server Basic Options` for a full description of this command. The imporoptions of this command are listed below.

Option	Usage
<code>commandPrompt</code>	The command prompt to send to clients.
<code>listenPort</code>	The port that the Telnet server listens on.
<code>closeCommand</code>	The value of the exit command expected from the client.
<code>supressGoAhead</code>	Suppress the 'go ahead' command.
<code>echo</code>	Causes the server to echo received characters.
<code>linemode</code>	Causes the line-mode option to be negotiated with the client.

## Telnet Server Advanced Options

The Telnet server advanced options control network level operation of the server. Refer to `Telnet Client Advanced Options` for a full description of this command. The important options of this command are:

Option	Usage
<code>enableEsm</code>	Enable the use of ESM.
<code>esm</code>	The ESM value.

## Telnet Client Agent

Telnet Client Agent - create a Telnet client

### SYNOPSIS

```
set Traffic1_Network1 [::IxLoad new ixNetTraffic]
set Activity_TelnetClient1 [$Traffic1_Network1 activityList.appendItem
$Activity_TelnetClient1 agent.config
```

### DESCRIPTION

A Telnet client agent is added to the `activityList` object. The `activityList` object is added to the `ixNetTraffic` object using the `appendItem` subcommand from the `ixConfigSequenceContainer` command.

### SUBCOMMANDS

None.

### OPTIONS

`enable`

Enables the use of this agent. (Default = true).

`implicitLoopCheck`

If this option is enabled (1), then the client progresses through the command list repeatedly until the test's sustain time. If the option is disabled (0), then the client will progress through the command list only once, and then go idle. (Default = 0).

`name`

The name associated with this object, which must be set at object creation time.

### STATISTICS

### EXAMPLE

```
set Traffic1_Network1 [::IxLoad new
ixNetTraffic]##### Activity Tel-
netClient1 of NetTraffic
Traffic1@Network1#####set Activity_Tel-
netClient1 [$Traffic1_Network1 activityList.appendItem \-protocolAndType
"Telnet Client" ]##### Timeline1 for
activities TelnetClient1#####set
Timeline1 [::IxLoad new ixTimeline]$Timeline1 config \-rampUpValue
```



```

1 \-rampUpType                0 \-offlineTime
0 \-rampDownTime              20 \-standbyTime
0 \-iterations                1 \-rampUpInterval
1 \-sustainTime               20 \-timelineType
0 \-name                       "Timeline1"$Activity_TelnetClient1 con-
fig \-enable                   true \-name
"TelnetClient1" \-enableConstraint false \-userObjectiveValue
100 \-constraintValue          100 \-userObjectiveType
"simulatedUsers" \-timeline    $Timeline1$Activity_Tel-
netClient1 agent.config \-enable true \-name
"TelnetClient1"$Activity_TelnetClient1 agent.pm.advanced.config \-enableTOS
true \-esm                      1460 \-enableEsm
true \-implicitLoopCheck        true \-typeOfService
"Best Effort (0x0)"$Activity_TelnetClient1 agent.pm.basic.config \-commandPrompt
"#\" \-expectTimeout            120 \-enableOptions
true$Activity_TelnetClient1 agent.pm.ipHistory.clear$Activity_TelnetClient1 agent.p-
m.ipHistory.appendItem \-id      "Ip" \-name
""$Activity_TelnetClient1 agent.pm.commands.clear$Activity_TelnetClient1 agent.p-
m.commands.appendItem \-id      "Tel-
netSessionCommand" \-userName   "root\[00-\]" \-
exitCommand                     "exit" \-loginPrompt
"login:" \-send                  "ls" \-commandPrompt
"{Default Command Prompt}" \-passwordPrompt "Password:" \-
symServerIP                     "Traffic2_TelnetServer1:23" \-expect
"{Default Command Prompt}" \-password      "password\[00-
\]"$Activity_TelnetClient1 agent.pm.availableTosList.clear$Activity_TelnetClient1
agent.pm.availableTosList.appendItem \-id
"AvailableTypeOfService" \-tos_value      "Best Effort
(0x0)"$Activity_TelnetClient1 agent.pm.availableTosList.appendItem \-id
"AvailableTypeOfService" \-tos_value      "Class 1
(0x20)"$Activity_TelnetClient1 agent.pm.availableTosList.appendItem \-id
"AvailableTypeOfService" \-tos_value      "Class 2
(0x40)"$Activity_TelnetClient1 agent.pm.availableTosList.appendItem \-id
"AvailableTypeOfService" \-tos_value      "Class 3
(0x60)"$Activity_TelnetClient1 agent.pm.availableTosList.appendItem \-id
"AvailableTypeOfService" \-tos_value      "Class 4
(0x80)"$Activity_TelnetClient1 agent.pm.availableTosList.appendItem \-id
"AvailableTypeOfService" \-tos_value      "Express For-
warding (0xA0)"$Activity_TelnetClient1 agent.pm.availableTosList.appendItem \-id
"AvailableTypeOfService" \-tos_value      "Control (0xC0)"

```

**SEE ALSO**[Telnet Client Basic Options](#)[Telnet Client Advanced Options](#)[Telnet Client Command](#)

Telnet

---

[ixNetTraffic](#)

## Telnet Client Basic Options

Telnet Client Basic Options - configure a Telnet client's basic options

### SYNOPSIS

```
set Traffic1_Network1 [::IxLoad new ixNetTraffic]
set Activity_TelnetClient1 [$Traffic1_Network1 activityList.appendItem
$Activity_TelnetClient1 agent.pm.basic.config
```

### DESCRIPTION

Telnet basic options are set through the `pm.basic` option of the Telnet Client Agent object.

### SUBCOMMANDS

None.

### OPTIONS

`commandPrompt`

The default value of the command prompt. This is referenced in `- Telnet Client Command expect option` as `{Default Command Prompt}`. (Default = "#").

`enableOptions`

If `true`, enables option negotiation with the Telnet server. (Default = 3).

`expectTimeout`

The time, in seconds, to wait for receipt of the expected response. (Default = 120).

### EXAMPLE

```
set Traffic1_Network1 [::IxLoad new
ixNetTraffic]##### Activity Tel-
netClient1 of NetTraffic
Traffic1@Network1#####set Activity_Tel-
netClient1 [$Traffic1_Network1 activityList.appendItem \-protocolAndType
"Telnet Client" ]$Activity_TelnetClient1 agent.pm.basic.config \-commandPrompt
"#" \-expectTimeout          120 \-enableOptions
true
```

### SEE ALSO

[Telnet Client Agent](#)

## Telnet Client Advanced Options

Telnet Client Advanced Options - configure a Telnet client's advanced options

### SYNOPSIS

```
set Traffic1_Network1 [::IxLoad new ixNetTraffic]
set Activity_TelnetClient1 [$Traffic1_Network1 activityList.appendItem
$Activity_TelnetClient1 agent.pm.advanced.config options...
```

### DESCRIPTION

Telnet advanced options are set through the `pm.advanced` option of the `Telnet Client Agent` object.

### SUBCOMMANDS

None.

### OPTIONS

`enableEsm`

If `true`, enables the use of ESM. (Default = `false`).

`esm`

If `enableEsm` is `true`, the ESM value to negotiate with. (Default = `1,460`).

### EXAMPLE

```
$Activity_TelnetClient1 agent.pm.advanced.config \-enableTOS
true \-esm 1460 \-enableEsm
true \-implicitLoopCheck true \-typeOfService
"Best Effort (0x0)"
```

### SEE ALSO

[Telnet Client Agent](#)

## Telnet Client Command

Telnet Client Command - configure a command that the Telnet client will execute

### SYNOPSIS

```
set Traffic1_Network1 [::IxLoad new ixNetTraffic]
set Activity_TelnetClient1 [$Traffic1_Network1 activityList.appendItem
$Activity_TelnetClient1 agent.pm.commands.appendItem
```

### DESCRIPTION

A Telnet command is added to the `pm.commands` option of the `Telnet Client Agent` object using its `appendItem`.

### SUBCOMMANDS

None.

### OPTIONS

`id`

Specifies the type of command defined. The remaining options in this command are dependent on this setting. One of:

Option	Usage
<code>OpenCommand</code>	Open a connection to a Telnet server.
<code>LoginCommand</code>	Login to the Telnet server, sending the user name.
<code>PasswordCommand</code>	Send a password.
<code>SendCommand</code>	Send an arbitrary string.
<code>ThinkCommand</code>	Wait for a random period of time within a specirange.
<code>ExitCommand</code>	Close the session with the Telnet server.
<code>"{LoopBegin}"</code>	An IxLoad command that you can add to the Command List to cause the commands between it and the <code>{Loop End}</code> to be executed a specified number of times.
<code>"{LoopEnd}"</code>	Ends the list of commands that will be executed by the preceding <code>{Loop Begin}</code> command.

### Options for id = OpenCommand

expect

The expected response from the command. (Default = "login:").

serverIP

The name or IP address of the Telnet server or Telnet server activity. (Default = "").

### Options for id = LoginCommand

expect

The expected response from the command. (Default = "Password:").

send

The login name to send to the Telnet server. (Default = "root").

You can insert sequence generators into this field to create unique entries automatically. For example:

```
$clnt_traffic agentList(0).pm.commands.appendItem \           -id
>LoginCommand" \           -send           "kaushik\[00-\]"           \
-expect           "Password:"
```

For information on how to use sequence generators, see the AutoSequence Generators appendix.

### Options for id = PasswordCommand

expect

The expected response from the command. The default value of this option may be referenced by using the text {Default Command Prompt}.

send

The password to send to the Telnet server. (Default = "root").

You can insert sequence generators into this field to create unique entries automatically.

```
$clnt_traffic agentList(0).pm.commands.appendItem \           -id           "Pass-
wordCommand" \           -send           "124444\[a-\]"           \           -
expect           "$"
```

For information on how to use sequence generators, see the AutoSequence Generators appendix.

### Options for id = SendCommand

expect

The expected response from the command. The default value of this option may be referenced by using the text {Default Command Prompt}.

send

The string to send to the Telnet server. (Default = "root").

## Options for id = ThinkCommand

maxInterval

The upper limit of a randomly chosen sleep, expressed in microseconds. (Default = 1,000)

minInterval

The lower limit of a randomly chosen sleep, expressed in microseconds. (Default = 1,000).

## Options for id = ExitCommand

send

The string to send to the Telnet server to exit the Telnet session. (Default = "exit").

### EXAMPLE

```
$Activity_TelnetClient1 agent.pm.commands.appendItem \-id
"TelnetSessionCommand" \-userName          "root\[00-\]" \-exitCommand
"exit" \-loginPrompt                       "login:" \-send          "ls"
\-\commandPrompt                          "{Default Command Prompt}" \-\passwordPrompt
"Password:" \-\symServerIP                 "Traffic2_TelnetServer1:23" \-\expect
"{Default Command Prompt}" \-\password    "password\[00-\]"
```

### SEE ALSO

[Telnet Client Agent](#)

## Telnet Server Agent

Telnet Server Agent - create a Telnet server

### SYNOPSIS

```
set Traffic2_Network2 [::IxLoad new ixNetTraffic]
set Activity_TelnetServer1 [$Traffic2_Network2 activityList.appendItem options...]
$Activity_TelnetServer1 agent.config
```

### DESCRIPTION

A Telnet server agent is added to the `activityList` object. The `activityList` object is added to the `ixNetTraffic` object using the `appendItem` subcommand from the `ixConfigSequenceContainer` command.

Each member of the list, however may be separately addressed and modified using the `ixConfig` subcommands.

### SUBCOMMANDS

The options for this command are configured and read using the standard `config`, `cget`, and `getOption` subcommands defined in the `ixConfig` command.

### OPTIONS

`enable`

Enables the use of this action. (Default = true).

`name`

The name associated with this object, which must be set at object creation time.

### STATISTICS

Note that a number of login failures may be visible in the statistics. These are caused by aborted logins at the time of test ramp-down.

### EXAMPLE

```
set Traffic2_Network2 [::IxLoad new
ixNetTraffic]##### Activity Tel-
netServer1 of NetTraffic
Traffic2@Network2#####set Activity_Tel-
netServer1 [$Traffic2_Network2 activityList.appendItem \-protocolAndType
"Telnet Server" ]set _Match_Longest_ [::IxLoad new ixMatchLongestTimeline]$Activity_
TelnetServer1 config \-enable true \-name
"TelnetServer1" \-timeline $_Match_Longest_$Activity_
```



```

TelnetServer1 agent.config \-enable true \-name
"TelnetServer1"$Activity_TelnetServer1 agent.pm.advanced.config \-enableTOS
true \-esm 1460 \-enableEsm
true \-typeOfService "Best Effort (0x0)"$Activity_Tel-
netServer1 agent.pm.basic.config \-linemode false \-
listenPort "23" \-echo
true \-commandPrompt "#" \-suppressGoAhead
true \-closeCommand "exit"$Activity_TelnetServer1 agent.p-
m.availableTosList.clear$Activity_TelnetServer1 agent.pm.availableTosList.appendItem
\ -id "AvailableTypeOfService" \-tos_value
"Best Effort (0x0)"$Activity_TelnetServer1 agent.pm.availableTosList.appendItem \-id
"AvailableTypeOfService" \-tos_value "Class 1
(0x20)"$Activity_TelnetServer1 agent.pm.availableTosList.appendItem \-id
"AvailableTypeOfService" \-tos_value "Class 2 (0x40)"

$Activity_TelnetServer1 agent.pm.availableTosList.appendItem \-id
"AvailableTypeOfService" \-tos_value "Class 3
(0x60)"$Activity_TelnetServer1 agent.pm.availableTosList.appendItem \-id
"AvailableTypeOfService" \-tos_value "Class 4
(0x80)"$Activity_TelnetServer1 agent.pm.availableTosList.appendItem \-id
"AvailableTypeOfService" \-tos_value "Express For-
warding (0xA0)"$Activity_TelnetServer1 agent.pm.availableTosList.appendItem \-id
"AvailableTypeOfService" \-tos_value "Control (0xC0)"

```

**SEE ALSO**[Telnet Server Basic Options](#)[Telnet Server Advanced Options](#)

## Telnet Server Basic Options

Telnet Server Basic Options - configure a Telnet server' basic options

### SYNOPSIS

```
set Traffic2_Network2 [::IxLoad new ixNetTraffic]
set Activity_TelnetServer1 [$Traffic2_Network2 activityList.appendItem options...]
$Activity_TelnetServer1 agent.pm.basic.config
```

### DESCRIPTION

Telnet basic options are set through the `pm.basic` option of the `Telnet Server Agent` object (see the example below).

### SUBCOMMANDS

None.

### OPTIONS

`closeCommand`

The value of the close command expected from the client. (Default = "exit").

`commandPrompt`

The command prompt to send to clients. (Default = "#").

`echo`

Causes the server to echo received characters. (Default = true).

`linemode`

Causes the line-mode option to be negotiated with the client. (Default = false).

`listenPort`

Port that the Telnet server listens on. To specify multiple ports, separate the port numbers with commas (,). You can specify up to 50 listening ports. (Default = 23).

`suppressGoAhead`

If true, suppress the 'go ahead' command. (Default = true).

### EXAMPLE

```
set Traffic2_Network2 [::IxLoad new
ixNetTraffic]##### Activity Tel-
netServer1 of NetTraffic
Traffic2@Network2#####set Activity_Tel-
netServer1 [$Traffic2_Network2 activityList.appendItem \-protocolAndType
```

```
"Telnet Server" ]$Activity_TelnetServer1 agent.pm.basic.config \-linemode  
false \-listenPort "23" \-echo  
true \-commandPrompt "#" \-suppressGoAhead  
true \-closeCommand "exit"
```

**SEE ALSO**

[Telnet Server Agent](#)

## Telnet Server Advanced Options

Telnet Server Advanced Options - configure a Telnet server's advanced options

### SYNOPSIS

```
set Traffic2_Network2 [::IxLoad new ixNetTraffic]
set Activity_TelnetServer1 [$Traffic2_Network2 activityList.appendItem options...]
$Activity_TelnetServer1 agent.pm.advanced.config
```

### DESCRIPTION

Telnet advanced options are set through the `pm.advanced` option of the `Telnet Server Agent` object (see the example below).

### SUBCOMMANDS

None.

### OPTIONS

`enableEsm`

If `true`, enables the use of ESM. (Default = `false`).

`esm`

If `enableEsm` is `true`, the ESM value to negotiate with. (Default = `1,460`).

### EXAMPLE

```
set Traffic2_Network2 [::IxLoad new
ixNetTraffic]##### Activity Tel-
netServer1 of NetTraffic
Traffic2@Network2#####set Activity_Tel-
netServer1 [$Traffic2_Network2 activityList.appendItem \-protocolAndType
"Telnet Server" ]$Activity_TelnetServer1 agent.pm.advanced.config \-enableTOS
true \-esm 1460 \-enableEsm
true \-typeOfService "Best Effort (0x0)"
```

### SEE ALSO

Telnet Server Agent

## Telnet Statistics

For the Telnet statistics, see the following sections.

[Telnet Client Statistics](#)

[Telnet Server Statistics](#)

For TCP statistics, see [TCP, Run State, and Curve Segment Statistics](#).

Statistics in the results files and reports are averaged over all ports. If a statistic for an interval is missing, IxLoad interpolates it from the statistic immediately prior to it and the statistic after it.

The test results are available from the location defined on the User Directories window. See User Directories.

## Telnet Client Statistics

The table below describes the Telnet client statistics.

Statistic	Description
<b>Connection Statistics</b>	
Telnet Active Connections	Number of active Telnet connections. <i>A connection</i> refers to the TCP connection established to start a Telnet session.
Telnet Total Connections Requested	Number Telnet connections requested by the client.
Telnet Total Connections Succeeded	Number of Telnet connections established by the client.
Telnet Total Connections Failed	Number of failed attempts to establish Telnet connections.
Telnet Total Connections Latency	Average amount of time required to establish a Telnet connection. Note for Tcl API users: This is a weighted statistic. If you are using this statistic in a Tcl script, use the <i>kWeightedAverage</i> aggregation type.
Telnet Total Sessions Completed	Total number of Telnet sessions in which all the Telnet commands in the session completed successfully. <i>A session</i> refers to a sequence of Telnet commands that begins with a Telnet OPEN command, may be followed by one or more Telnet commands, and ends by being terminated with a Telnet EXIT command. If the each command in the sequence is completed successfully, the session is counted as being completed successfully.
Telnet Total Sessions Not Completed	Total number of Telnet sessions that were established but in which one or more commands did not complete successfully.
Telnet Average Session Length	Average Telnet session duration. Note for Tcl API users: This is a weighted statistic. If you are using this statistic in a Tcl script, use the <i>kWeightedAverage</i> aggregation type.
<b>Login Statistics</b>	
Telnet Total Login Prompts Received	Total number of login prompts received.

Telnet Total Login Prompts Not Received	Total number instances in which the client connected to the server but did not receive a login prompt in return.
Telnet Total Password Prompts Received	Total number of password prompts received.
Telnet Total Password Prompts Not Received	Total number of instances in which the client sent a user name to the server but did not receive a password prompt in return.
Telnet Total Logins Sent	Total number of logins sent by the clients.
Telnet Total Logins Succeeded	Total number of successful logins by the clients.
Telnet Total Logins Failed	Total number of login attempts that failed.
Telnet Total Logins Failed (Timed Out)	Total number of login attempts that failed because a response was not received within the timeout period.
Telnet Total Logins Failed (Other)	Total number of login attempts that failed for reasons other than a timeout.
Telnet Total Passwords Sent	Total number of passwords sent by the client.
Telnet Total Passwords Succeeded	Total number of passwords that succeeded.
Telnet Total Passwords Failed	Total number of passwords that failed.
Telnet Total Passwords Failed (Timed Out)	Total number of passwords that failed because no response was received within the timeout period.
Telnet Total Passwords Failed (Other)	Total number of passwords that failed for reasons other than a timeout.
<b>Transaction Statistics</b>	

Telnet Total Transactions	Total number of Telnet transactions completed. One transaction consists of a LOGIN, PASSWORD, SEND, or EXIT command and the response to it.
Telnet Total Commands Sent	Total number of SEND commands sent by the client.
Telnet Total Commands Succeeded	Number of SEND commands during a Telnet session that succeeded. IxLoad considers a command to be successful if the client sent a SEND command to the server and the server returned the expected string.
Telnet Total Commands Failed	Number of SEND commands that failed. IxLoad considers a command to have failed if the client sent a SEND command to the server and the server did not return the expected string.
Telnet Total Commands Failed (Timed Out)	Total number of SEND commands that failed because no response was received within the timeout period.
Telnet Total Commands Failed (Other)	Total number of SEND commands that failed for reasons other than a timeout.
<b>Bytes Statistics</b>	
Telnet Total Bytes Sent	Total number of bytes sent over Telnet connections.
Telnet Total Bytes Received	Total number of bytes received by the client over Telnet.
Telnet Total Bytes Sent And Received	Total number of bytes sent and received by the client over Telnet.
Telnet Total Throughput	Total throughput over Telnet.
<b>Echo Options Statistics</b>	
Telnet Total Echo Options Do Received	Number of requests received from the server to begin using the Echo option.
Telnet Total Echo Options Dont Received	Number of requests received from the server to stop using the Echo option.



Telnet Total Echo Options Will Received	Number of responses received from the server agreeing to use the Echo option.
Telnet Total Echo Options Wont Received	Number of responses received from the server rejecting use of the Echo option.
Telnet Total Echo Options Do Sent	Number of requests sent to the server to begin using the Echo option.
Telnet Total Echo Options Dont Sent	Number of requests sent to the server to stop using the Echo option.
Telnet Total Echo Options Will Sent	Number of responses sent by the client agreeing to use the Echo option.
Telnet Total Echo Options Wont Sent	Number of responses sent by the client rejecting use of the Echo option.
<b>Suppress Go Ahead Options</b>	
Telnet Total Suppress Go Ahead Options Do Received	Number of requests received from the server to begin using the Go Ahead option.
Telnet Total Suppress Go Ahead Options Dont Received	Number of requests received from the server to stop using the Go Ahead option.
Telnet Total Suppress Go Ahead Options Will Received	Number of responses received from the server agreeing to use the Go Ahead option.
Telnet Total Suppress Go Ahead Options Wont Received	Number of responses received from the server rejecting use of the Go Ahead option.
Telnet Total Suppress Go Ahead Options Do Sent	Number of requests sent to the server to begin using the Go Ahead option.

Telnet Total Suppress Go Ahead Options Don't Sent	Number of requests sent to the server to stop using the Go Ahead option.
Telnet Total Suppress Go Ahead Options Will Sent	Number of responses sent by the client agreeing to use the Go Ahead option.
Telnet Total Suppress Go Ahead Options Wont Sent	Number of responses sent by the client rejecting use of the Go Ahead option.
<b>Line Mode Options Statistics</b>	
Telnet Total Line Mode Options Do Received	Number of requests received from the server to begin using the Line Mode option.
Telnet Total Line Mode Options Dont Received	Number of requests received from the server to stop using the Line Mode option.
Telnet Total Line Mode Options Will Received	Number of responses received from the server agreeing to use the Line Mode option.
Telnet Total Line Mode Options Wont Received	Number of responses received from the server rejecting use of the Line Mode option.
Telnet Total Line Mode Options Do Sent	Number of requests sent to the server to begin using the Line Mode option.
Telnet Total Line Mode Options Dont Sent	Number of requests sent to the server to stop using the Line Mode option.
Telnet Total Line Mode Options Will Sent	Number of responses sent by the client agreeing to use the Line Mode option.
Telnet Total Line Mode Options Wont Sent	Number of responses sent by the client rejecting use of the Line Mode option.
<b>Sub-Options Statistics</b>	

---

Telnet Total Sub-options Received	Total number of Telnet sub-options received by the client.
Telnet Total Sub-options Sent	Total number of Telnet sub-options sent by the client.
<b>Line Mode Sub-Options Edit Mask Statistics</b>	
Telnet Total Line Mode Suboptions Edit Mask Received	Total number of Telnet sub-option edit masks received by the client.
Telnet Total Line Mode Suboptions Edit Mask Sent	Total number of Telnet sub-option edit masks sent by the client.

## Telnet Server Statistics

The table below describes the Telnet server statistics.

Statistic	Description
<b>Connection Statistics</b>	
Telnet Active Connections	Number of Telnet connections up. <i>A connection</i> refers to the TCP connection established to start a Telnet session.
Telnet Total Accepted Connections	Total number of requests for Telnet connections accepted by the server.
<b>Username Statistics</b>	
Telnet Login Prompts Sent	Number of login prompts sent by the server to the clients.
Telnet UserNames Succeeded	Number of user names accepted by the server.
Telnet UserNames Failed	Number of instances in which the server did not receive a user name for any reason.
Telnet UserNames Failed (Timed Out)	Number of instances in which the server did not receive a user name within the timeout period.
Telnet UserNames Failed (Other)	Number of instances in which the server did not receive user names for reasons other than a timeout.
<b>Password Statistics</b>	
Telnet Password Prompts Sent	Number of password prompts sent by the server to the clients.
Telnet Passwords Succeeded	Number of passwords accepted by the server.
Telnet Passwords Failed	Number of passwords rejected for any reason by the server.
Telnet Passwords Failed (Timed Out)	Number of passwords rejected by the server because they were not received within the specified time.
Telnet Passwords Failed (Other)	Number of passwords rejected by the server for reasons other than a timeout.

<b>Login Statistics</b>	
Telnet Logins Succeeded	Number of successful logins to the server. A successful login occurs when the server received a user name and password from the client and then returned a command prompt.
Telnet Logins Failed	Number of attempts to login to the server that failed.
<b>Transaction Statistics</b>	
Telnet Commands Processed	Total number of SEND commands received over Telnet connections and executed on the server.
<b>Byte Statistics</b>	
Telnet Total Bytes Sent	Total number of bytes sent over Telnet connections by the server.
Telnet Total Bytes Received	Total number of bytes received over Telnet connections by the server.
Telnet Total Bytes Sent And Received	Total number of bytes sent and received over Telnet by the server.
Telnet Total Throughput	Total Telnet throughput.
<b>Generic Option Statistics</b>	
Telnet Option Negotiation Failed	Total number of attempts to negotiate Telnet options that failed for any reason.
Telnet Option Negotiation Failed (Timed Out)	Total number of attempts to negotiate Telnet options that failed because no response was received within the timeout period.
Telnet Option Negotiation Failed (Other)	Total number of attempts to negotiate Telnet options that failed for reasons other than a timeout.
<b>Generic Sub-Option Statistics</b>	
Telnet Suboption Negotiation Failed	Total number of attempts to negotiate Telnet sub-options that failed for any reason.
Telnet Suboption Negotiation Failed (Timed Out)	Total number of attempts to negotiate Telnet sub-options that failed because no response was received within the timeout period.
Telnet Suboption Negotiation Failed (Other)	Total number of attempts to negotiate Telnet sub-options that failed for reasons other than a timeout.
<b>Echo Option Statistics</b>	

Telnet Echo Options DO Sent	Number of requests sent by the server to the client to begin using the Echo option.
Telnet Echo Options WILL Sent	Number of responses sent by the server agreeing to begin using the Echo option.
Telnet Echo Options DONT Sent	Number of requests sent by the server to the client to stop using the Echo option.
Telnet Echo Options WONT Sent	Number of responses sent by the server rejecting use of the Echo option.
Telnet Echo Options DO Received	Number of requests received by the server to begin using the Echo option.
Telnet Echo Options WILL Received	Number of responses received by the server agreeing to begin using the Echo option.
Telnet Echo Options DONT Received	Number of responses received by the server rejecting use of the Echo option.
Telnet Echo Options WONT Received	Number of responses received by the server agreeing to stop using the Echo option.
<b>GA Suppress Option Statistics</b>	
Telnet GA Suppress Options DO Sent	Number of requests sent by the server to suppress Go Ahead messages. Effectively, the server requests the clients not to send Go Ahead messages.
Telnet GA Suppress Options WILL Sent	Number of the responses sent by the server agreeing to suppress Go Ahead messages.
Telnet GA Suppress Options DONT Sent	Number of requests sent by the server asking the clients not to suppress Go Ahead messages. Effectively, the server requests that the clients send Go Ahead messages.
Telnet GA Suppress Options WONT Sent	Number of responses sent by the server rejecting suppression of Go Ahead messages. Effectively, the server signals that it will send Go Ahead messages.
Telnet GA Suppress Options DO Received	Number of requests received by the server to suppress Go Ahead messages. Effectively, the server is being requested to not send Go Ahead messages.

Telnet GA Suppress Options WILL Received	Number of responses received by the server indicating that the client will suppress Go Ahead messages. Effectively, the clients agree to not send Go Ahead messages.
Telnet GA Suppress Options DONT Received	Number of requests received by the server to not suppress Go Ahead messages. Effectively, the server is being requested to send Go Ahead messages.
Telnet GA Suppress Options WONT Received	Number of responses received by the server indicating that the client will not suppress Go Ahead messages. Effectively, the clients agree to send Go Ahead messages.
<b>Line-Mode Option Statistics</b>	
Telnet Line-mode Options DO Sent	Number of requests sent by the server to the clients to begin using the Line Mode option.
Telnet Line-mode Options WILL Sent	Number of responses sent by the server agreeing to begin using the Line mode option.
Telnet Line-mode Options DONT Sent	Number of requests sent by the server to the clients to stop using the Line Mode option.
Telnet Line-mode Options WONT Sent	Number of responses sent by the server agreeing to stop using the Line mode option.
Telnet Line-mode Options DO Received	Number of requests received by the server to begin using the Line Mode option.
Telnet Line-mode Options WILL Received	Number of responses received by the server agreeing to begin using the Line Mode option.
Telnet Line-mode Options DONT Received	Number of requests received by the server to stop using the Line Mode option.
Telnet Line-mode Options WONT Received	Number of responses received by the server rejecting use of the Line Mode option.
<b>Line-Mode Sub-Option Statistics</b>	
Telnet Line-mode Sub-options Sent	Number of messages setting the Line Mode sub-options sent by the server.
Telnet Line-mode Sub-options Received	Number of messages setting the Line Mode sub-options received by the server.
<b>Special Statistics</b>	

Telnet Line-mode Edit Mask Sent	Number of Line Mode Edit Mask messages sent by the server.
Telnet Line-mode Edit Mask Received	Number of Line Mode Edit Mask messages received by the server.



# TFTP

This section describes the TFTP Tcl API objects.

## Overview

The IxLoad TFTP API consists of a client agent and its commands, structured as shown below.

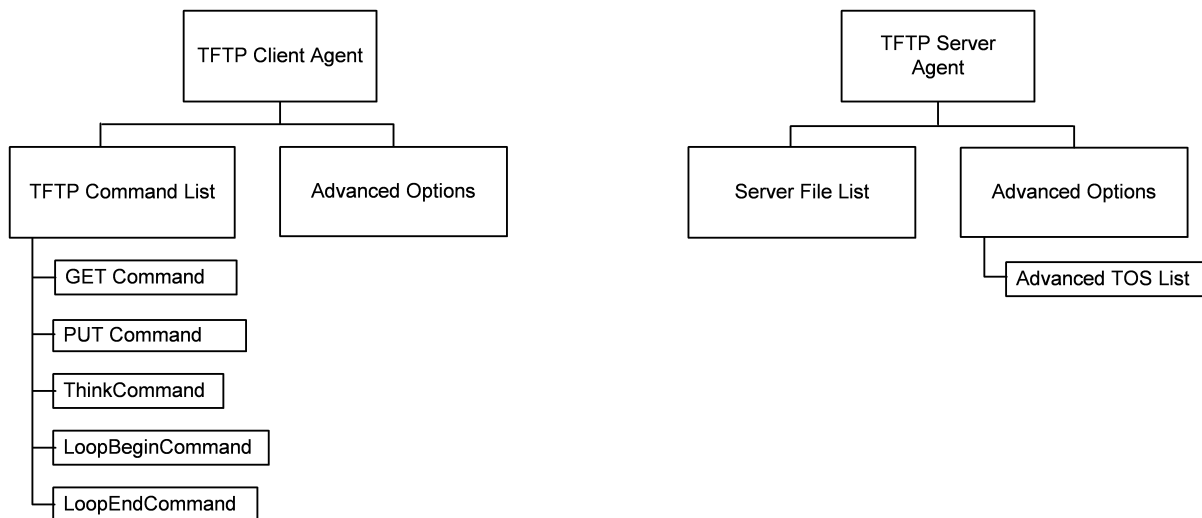

## Objectives

The objectives (userObjective) you can set for TFTP are listed below. Test objectives are set in the ixTimeline object.

- transactionRate
- simulatedUsers

## TFTP Client Agent

Trivial File Transfer Protocol (TFTP) is a very simple file transfer protocol that functions essentially like a stripped-down version of FTP. Refer to `TFTP Client Agent` on page 26-3 for a full description of this command. The most significant options of this command are listed below.

Option	Description
enable	Enables the use of the TFTP client agent.
name	Name associated with the client agent.

## TFTP Command List

The TFTP Command List creates the list of TFTP commands that the client will send to a TFTP server. Refer to `TFTP Command List` on page 26-8 for a full description of this command. The most significant options of this command are listed below.

Option	Description
id	Command that client will send.

## TFTP Client Advanced Options

The TFTP client advanced options define additional connection options. Refer to `TFTP Client Advanced` for a full description of this command. The important options of this command are listed below.

Option	Usage
responseTimeout	Time, in seconds, that the client waits for a response from the server.
ipPreference	If you have a mixture of IPv4 and IPv6 subnets configured on the client network, these fields select the order that the TFTP client will use the subnets.
numberOfRetries	Number of times that the TFTP client will re-send an un-acknowledged GET (RRQ packet) or PUT (WRQ packet) command.



## TFTP Client Agent

TFTP Client Agent - create a TFTP client

### SYNOPSIS

```
set Traffic1_Network1 [::IxLoad new ixNetTraffic]
set Activity_TFTPClient1 [$Traffic1_Network1 activityList.appendItem \ options...]
$Activity_TFTPClient1 agent.config \
```

### DESCRIPTION

A TFTP client agent is added to the `activityList` option of the `ixNetTraffic` object using the `appendItem` subcommand from the `ixConfigSequenceContainer` command. Other `ixConfigSequenceContainer` subcommands may be used to modify the `agentList`. It is customary to set all the options of the client agent during the `appendItem` call.

Each member of the list, however may be separately addressed and modified using the `ixConfig` subcommands.

### SUBCOMMANDS

The options for this command are configured and read using the standard `config`, `cget`, and `getOption` subcommands defined in the `ixConfig` command.

### OPTIONS

`enable`

Enables the use of this client agent. (Default = true).

`name`

The name associated with this object, which must be set at object creation time.

### STATISTICS

#### EXAMPLE

```
set Traffic1_Network1 [::IxLoad new ixNetTraffic]#-----
-----# Activity TFTPClient1 of NetTraffic Traffic1@Network1#-----
-----set Activity_TFTPClient1 [$Traffic1_
Network1 activityList.appendItem \-protocolAndType          "tftp Cli-
ent" ]$Activity_TFTPClient1 agent.config \-enable
true \-name                    "TFTPClient1"
```

### SEE ALSO

[ixNetTraffic](#)



## TFTP Command List

TFTP Command List—Creates the list of TFTP commands that the client will send to a TFTP server.

### SYNOPSIS

```
set Traffic1_Network1 [::IxLoad new ixNetTraffic]
$Activity_TFTPClient1 agent.pm.cmdList.appendItem \ options...
```

### DESCRIPTION

A command is added to the TFTP Command List object using the `appendItem` subcommand from the `ixConfigSequenceContainer` command.

### SUBCOMMANDS

The options for this command are configured and read using the standard `config`, `cget`, and `getOptions` subcommands defined in the `ixConfig` command.

### OPTIONS

`id`

TFTP command to be executed. One of the following:

Command	Description
GETCommand	The GET command retrieves a file from a TFTP Server by sending an RRQ (Read request) packet.
PUTCommand	The PUT command stores a file on a server by sending a WRQ request. The file can be an actual file, or a dummy file that consists of generated data.
ThinkCommand	The THINK Command causes the client to become idle for a specified length of time, to simulate real-world usage scenarios in which a user may spend time absorbing or processing information received from the server before sending the next command. If you specify identical values for the minimum and maxintervals, the client will be inactive for a fixed length of time. If you specify different values for the minand maximum intervals, IxLoad will select a value within the range and cause the client to be inactive for that length of time.
LoopBeginCommand	The Loop BeginCommand is an IxLoad command that you can add to the Command List to cause the combetween it and the LoopEndCommand to be executed a specified number of times.
LoopEndCommand	LoopEndCommand ends the list of commands that will be executed by the preceding LoopBeginCommand.

## Arguments for id = GET Command

`getFileName`

Specifies the name and path of the file to be retrieved. The file path must be Unix-style. For example: `/abcd/foo.txt`

You can include sequence generators in this field to generate requests for multiple files automatically. (Default = "").

`enableFileSizeOption`

If enabled, the client includes the Transfer Size (`tsize`) option in the RRQ packet, with the value set to 0. (Default = "0").

`transportMode`

Type of data contained in file to be transferred:

Value	Description
<code>netascii</code> (Default)	0
<code>octet</code>	1

`enableBlkSizeOption`

If `true`, the client suggests the size of the Data field to be used in DATA packets from the server. (Default = "0").

`enableTimeoutOption`

If enabled, the client includes the Timeout (`tout`) option in the RRQ packet, with the value configured on the Advanced Options. (Default = "0").

`blksize`

Specifies the value of the block size, if it is enabled. (Default = "512").

`serverAddr`

IP address and port number of the external TFTP server. If you do not specify a port number, the IxLoad client uses port 69. (Default = "198.18.0.100" ).

## Arguments for id = PUT Command

`fileType`

The file type can be of:

Value	Description
real file (Default)	0
dummy file	1

transportMode

Type of data contained in file to be transferred:

Value	Description
netascii (Default)	0
octet	1

enableBlkSizeOption

If true, the client suggests the size of the Data field to be used in DATA packets from the server. (Default = "0").

remoteFileName

Name and path that the file will be stored on the remote server. (Default = "").

dummyFileRange

If selected as fileType, the IxLoad TFTP client transfers a file composed of generrandom data. (Default = "8-8").

blksize

Specifies the value of the block size, if it is enabled. (Default = "512").

serverAddr

IP address and port number of the external TFTP server. If you do not specify a port number, the IxLoad client uses port 69. (Default = "198.18.0.100" ).

putFileName

Specifies the name of the file. (Default = "").

### Arguments for id = ThinkCommand

minimumInterval

Minimum length of time that the client is idle. Minimum = "1000," maximum = "2,147,483,647." (Default = "1000").



---

maximumInterval

Maximum length of time that the client is idle. Minimum = "1000," maximum = "2,147,483,647."  
(Default = "1000").

### Arguments for id = LoopBeginCommand

loopCount

Number of times to repeat the enclosed commands. '0' treated as infinity. Mini= "0," maximum = "2,147,483,647." (Default = "5").

### Arguments for id = LoopEndCommand

None.

### EXAMPLE

```
$Activity_TFTPClient1 agent.pm.cmdList.appendItem \-id
"GET" \-getFileName                "" \-enableFileSizeOption
false \-transportMode              0 \-enableBlkSizeOption
false \-enableTimeoutOption        false \-blksize
"512" \-serverAddr                 "198.18.0.100"
```

### SEE ALSO

[TFTP Client Agent](#)

## TFTP Client Advanced

TFTP Client Advanced Options - configure a TFTP client's advanced options

### SYNOPSIS

```
set Traffic1_Network1 [::IxLoad new ixNetTraffic]
set Activity_TFTPClient1 [$Traffic1_Network1 activityList.appendItem \.]
$Activity_TFTPClient1 agent.pm.advOptions.config options...
```

### DESCRIPTION

A TFTP client's advanced options are set by modifying the options of the `pm.advanced` option of the `TFTP Client Agent` object using its `appendItem`.

### SUBCOMMANDS

None.

### OPTIONS

`responseTimeout`

Time, in seconds, that the client waits for a response from the server. You can enter values from 1 to 255 seconds.

This value is included as the value for the `Tout` option included with an `RRQ` (GET command) or `WRQ` (PUT command). Minimum = "1", Maximum = "2147483", Default = "20".

`ipPreference`

If you have a mixture of IPv4 and IPv6 subnets configured on the client network, these fields select the order that the TFTP client will use the subnets. The values are:

Value	Description
0	IPv4: The client will use addresses from the IPv4 subnets only.
1	IPv6: The client will use addresses from the IPv6 subnets only.
2 (default)	Both, IPv4 first: The client will use addresses from the IPv4 subnets first, then if it needs more addresses, it will use addresses from the IPv6 subnets.
3	Both, IPv6 first: The client will use addresses from the IPv6 subnets first, then if it needs more addresses, it will use addresses from the IPv4 subnets.

`numberOfRetries`

Number of times that the TFTP client will re-send an un-acknowledged GET (RRQ packet) or PUT (WRQ packet) command. (Default = "3").

**EXAMPLE**

```
$Activity_TFTPClient1 agent.pm.advOptions.config \-responseTimeout
120 \-implicitLoopCheck           true \-ipPreference
2 \-numberOfRetries                3
```

**SEE ALSO**

[TFTP Client Agent](#)

[TFTP Command List](#)

## TFTP Server Agent

TFTP Server Agent - create a TFTP server

### SYNOPSIS

```
set Activity_TFTPServer1 [$myNetTraffic activityList.appendItem \  
-protocolAndType          "tftp Server" ]
```

### DESCRIPTION

A TFTP server agent is added to the `activityList` option of the `ixNetTraffic` object using the `appendItem` subcommand from the `ixConfigSequenceContainer` command. Other `ixConfigSequenceContainer` subcommands may be used to modify the `agentList`. It is customary to set all the options of the client agent during the `appendItem` call.

Each member of the list, however may be separately addressed and modified using the `ixConfig` subcommands.

### SUBCOMMANDS

The options for this command are configured and read using the standard `config`, `cget`, and `getOption` subcommands defined in the `ixConfig` command.

### OPTIONS

`enable`

Enables the use of this server agent. (Default = true).

`name`

The name associated with this object, which must be set at object creation time.

`timeline`

The name of the timeline to be used with this object.

### STATISTICS

### EXAMPLE

```
set Activity_TFTPServer1 [$myNetTraffic activityList.appendItem \  
-protocolAndType          "tftp Server" ]
```

```
set _Match_Longest_ [::IxLoad new ixMatchLongestTimeline]
```

```
$Activity_TFTPServer1 config \  
-enable          true \  
-name            "TFTPServer1" \  
-timeline        $_Match_Longest_
```

**SEE ALSO**

ixNetTraffic

## fileList

fileList - add files to a TFTP server

### SYNOPSIS

```
$Activity_TFTPServer1 agent.pm.files.fileList.appendItem \-id  
"File" \-filePath                "<Dummy File>" \-fileName  
"/#1"
```

### DESCRIPTION

The `fileList` object adds files to the list of files hosted by a TFTP server. Files can be real files or simulated ("dummy") files.

To add a file to the list, you use the `appendItem` subcommand from the `ixConfigSequenceContainer` command. Other `ixConfigSequenceContainer` subcommands may be used to modify the `fileList`. It is customary to set all the options of the `fileList` during the `appendItem` call.

Each member of the list, however may be separately addressed and modified using the `ixConfig` subcommands.

Before you add items to the `fileList`, you should initialize the list by using the `clear` subcommand of the `ixConfigSequenceContainer` command.

### SUBCOMMANDS

#### OPTIONS

`id`

Server file list name. (Default = "File").

`filePath`

For an actual file, this is the name and full path of the file. For a simulated file, this is `<Dummy File>`. (Default = "`<Dummy File>`").

`fileName`

For an actual file, `fileName` is the label of the file, as advertised by the server. For a simulated file, `fileName` is the size of the file, in the format `/#n`, where `n` is the size in bytes. For example, for a 64-byte simulated file, specify `/#64`. (Default = `"/#1"`).

### STATISTICS

### EXAMPLE

```
$Activity_TFTPServer1 agent.pm.files.fileList.clear
```

```
$Activity_TFTPServer1 agent.pm.files.fileList.appendItem \
```

```
-id                "File" \  
-filePath          "<Dummy File>" \  
-fileName          "/#1"
```

**SEE ALSO**

## advanced

advanced - configure a TFTP server's global properties

### SYNOPSIS

```
$Activity_TFTPServer1 agent.pm.advanced.config \-enableTOS  
false \
```

### DESCRIPTION

The `advanced` object configures the TFTP server's global properties. .

### SUBCOMMANDS

#### OPTIONS

`enableTOS`

Enables use of Type of Service (TOS) bits in TFTP packets. Configure the selected ToS type in `typeOfService`. Default = "false".

`enableFileSizeOption`

If enabled and the server receives a GET or PUT request from client with the File Size Option set, the server responds by sending an OACK with containing the size of file size, in octets. Default = "false".

`enableBlkSizeOption`

Causes the server to negotiate a Block Size with the client. Configure the server's Block Size value in the `blkSize` option. Default = "false".

`enableTimeoutOption`

Causes the server to negotiate a timeout interval with the client. Configure the server's timeout value in the `responseTimeOut` field. Default = "false".

`typeOfService`

ToS bit set in traffic from the TFTP server. To configure the list of allowed ToS settings, create an `availableTosList` object. Default = "Best Effort (0x0)".

`blkSize`

Block size used when `enableBlkSizeOption` is true. Default = "512".

`retryCount`

Number of DATA or ACK/OACK packets to be re-sent to the client if no response is received. Default = "3".

`responseTimeOut`



---

Length of time, in seconds, that the server waits for a response from the client. Default = "120".

tftpPort

Port number that the TFTP server listens on. Default = "69".

## STATISTICS

### EXAMPLE

```
$Activity_TFTPServer1 agent.pm.advanced.config \  
-enableTOS                false \  
-enableFileSizeOption     false \  
-enableBlkSizeOption      false \  
-enableTimeoutOption      false \  
-typeOfService            "Best Effort (0x0)" \  
-blkSize                   "512" \  
-retryCount                3 \  
-responseTimeOut          120 \  
-tftpPort                  69
```

### SEE ALSO

## TFTP Client Statistics

The table below describes the TFTP client statistics.

Statistic	Description
<b>Test Objective Statistics</b>	
TFTP Simulated Users	Number of TFTP users simulated.
TFTP Transactions	Number of TFTP transactions completed.
TFTP Transaction Rate	Rate at which TFTP transactions were completed.
<b>Upload / Download Statistics</b>	
TFTP Total File Download Requests Sent	Number of GET commands (RRQ requests) sent by the client.
TFTP Total File Download Requests Successful	Number of files that the client successfully downloaded.
TFTP Total File Download Requests Failed	Number of files that the client failed to download.
TFTP Total File Upload Requests Sent	Number of PUT commands (WRQ requests) sent by the client.
TFTP Total File Upload Requests Successful	Number of files that the client successfully uploaded.
TFTP Total File Upload Requests Failed	Number of files that the client failed to upload.
<b>ACK / OACK Statistics</b>	

TFTP Total Acknowledgement (ACK) Sent	Number of ACK packets sent by the client.
TFTP Total Acknowledgement (ACK) Received	Number of ACK packets received by the client.
TFTP Total Option Acknowledgement (OACK) Received	Number of OACK packets received by the client.
<b>Bytes Sent / Received Statistics</b>	
TFTP Total Bytes Sent	Total number of bytes sent in TFTP packets of all types.
TFTP Total Bytes Received	Total number of bytes received in TFTP packets of all types.
TFTP Total Bytes Sent And Received	Combined total of bytes sent and received in TFTP packets of all types.
<b>Data Bytes Sent / Received Statistics</b>	
TFTP Total Data Bytes Sent	Number of bytes sent in DATA packets.
TFTP Total Data Bytes Received	Number of bytes received in DATA packets.
TFTP Total Data Bytes Sent per sec	Rate, in bytes per second, at which the client sent DATA packets.
TFTP Total Data Bytes Received per sec	Rate, in bytes per second, at which the client received DATA packets.
<b>Bytes Sent / Received Rate Statistics</b>	
TFTP Total Bytes Sent per sec	Rate, in bytes per second, at which the client sent TFTP packets of all types.
TFTP Total Bytes Received per sec	Rate, in bytes per second, at which the client received TFTP packets of all types.

TFTP Total Bytes Sent And Received per sec	Combined rate, in bytes per second, at which the client sent and received TFTP packets of all types.
TFTP Total Out of Sequence Packets Received	Number of TFTP packets that were received out of order.
<b>Error Statistics</b>	
TFTP Total Timeouts Received	Number of timeouts received.
TFTP Total Errors	Number of ERROR packets received by the client.
TFTP Total Errors Received In Response to Read Request	Number of ERROR packets that the client received in response to a GET command (RRQ request).
TFTP Total Errors Received In Response to Write Request	Number of ERROR packets that the client received in response to a PUT command (WRQ request).
TFTP ERROR Received (code 0)	Number of ERROR packets received with error code 0 (Not defined, see error message (if any)).
TFTP ERROR Received (code 1)	Number of ERROR packets received with error code 1 (File not found).
TFTP ERROR Received (code 2)	Number of ERROR packets received with error code 2 (Access violation).
TFTP ERROR Sent (code 3)	<p>Number of ERROR packets sent with error code 3 (Disk full or allocation exceeded).</p> <p>In addition to sending error code 3 packets in case of <i>disk full</i> or <i>allocation exceeded</i> errors, the client will also send an error code 3 packet if the server responds to the client's RRQ with an OACK that contains a tsize that the client cannot handle.</p>

TFTP ERROR Received (code 3)	Number of ERROR packets received with error code 3 (Disk full or allocation exceeded). In addition to receiving error code 3 packets in case of <i>disk full</i> or <i>allocation exceeded</i> errors on the server, if the client sends a WRQ with a tsize that the server cannot handle, the server returns an error code 3 packet.
TFTP ERROR Received (code 4)	Number of ERROR packets received with error code 4 (Illegal TFTP operation).
TFTP ERROR Received (code 5)	Number of ERROR packets received with error code 5 (Unknown transfer ID).
TFTP ERROR Received (code 6)	Number of ERROR packets received with error code 6 (File already exists).
TFTP ERROR Received (code 7)	Number of ERROR packets received with error code 7 (No such user).
TFTP ERROR Sent (code 8)	Number of ERROR packets sent with error code 8 (Block size rejected).
TFTP ERROR Received (code 8)	Number of ERROR packets received with error code 8 (Block size rejected).
TFTP Other error	Number of ERROR packets received that were not error codes 1-8.

## TFTP Server Statistics

The table below describes the TFTP server statistics.

Statistic	Description
<b>TFTP Request / Response Statistics</b>	
TFTP Total Download Request Received	Number of GET requests received.
TFTP Total Download Request Succeeded	Number of GET requests completed successfully.
TFTP Total Download Request Failed	Number of GET requests that failed.
TFTP Total Upload Request Received	Number of PUT requests received.
TFTP Total Upload Request Succeeded	Number of PUT requests completed successfully.
TFTP Total Upload Request Failed	Number of PUT requests that failed.
TFTP Total ACK Sent	Number of ACK responses sent.
TFTP Total ACK Received	Number of ACK responses received.
TFTP Total OACK Sent	Number of OACK responses sent.
<b>Total Bytes Stats</b>	
TFTP Total Bytes Sent	Number of bytes sent in TFTP packets of all types.
TFTP Total Bytes Received	Number of bytes received in TFTP packets of all types.
TFTP Total Bytes Sent And Received	Combined total of bytes sent and received in TFTP packets of all types.
TFTP Throughput	Combined rate, in bytes per second, at which the server sent and received TFTP packets of all types.
<b>Data Bytes Statistics</b>	
TFTP Total Data Bytes Sent	Number of bytes sent in DATA packets.

TFTP Total Data Bytes Received	Number of bytes received in DATA packets.
TFTP Total Data Bytes Sent And Received	Combined total of bytes sent and received in DATA packets.
TFTP Data Throughput	Combined rate, in bytes per second, at which the server sent and received DATA packets.
<b>Error Statistics</b>	
TFTP Total Errors Received	Total number of TFTP error messages received.
TFTP Total Timeout Errors	Number of times that the server did not receive a response within the timeout period.
TFTP ERROR Sent (code 0)	Number of error code 0 messages sent. Error code 0 is undefined; a description of the error may be in the string portion of the message.
TFTP ERROR Sent (code 1)	Number of error code 1 messages sent. Error code 1 is: File not found.
TFTP ERROR Sent (code 2)	Number of error code 2 messages sent. Error code 2 is: Access violation.
TFTP ERROR Received (code 3)	Number of error code 3 messages received. Error code 3 is: Disk full or allocation exceeded.
TFTP ERROR Sent (code 3)	Number of error code 3 messages sent. Error code 3 is: Disk full or allocation exceeded.
TFTP ERROR Sent (code 4)	Number of error code 4 messages received. Error code 4 is: Illegal TFTP operation.
TFTP ERROR Sent (code 5)	Number of error code 5 messages received. Error code 5 is: Unknown transfer ID.
TFTP ERROR Sent (code 6)	Number of error code 6 messages received. Error code 6 is: File already exists.
TFTP ERROR Sent (code 7)	Number of error code 7 messages received. Error code 7 is: No such user.

TFTP ERROR Received (code 8)	Number of error code 8 messages received. Error code 8 is sent to terminate a transfer due to a failure in option negotiation.
TFTP ERROR Sent (code 8)	Number of error code 8 messages received. Error code 8 is sent to terminate a transfer due to a failure in option negotiation.
TFTP Other error	Number of TFTP errors that were not classified as error code 0-8.



# Trace File Replay

This section describes the Trace File Replay Tcl API objects.

## Overview

The IxLoad Trace File Replay API consists of client agent and server agents and their commands.

Figure 22-1. Trace File Replay Client API Structure

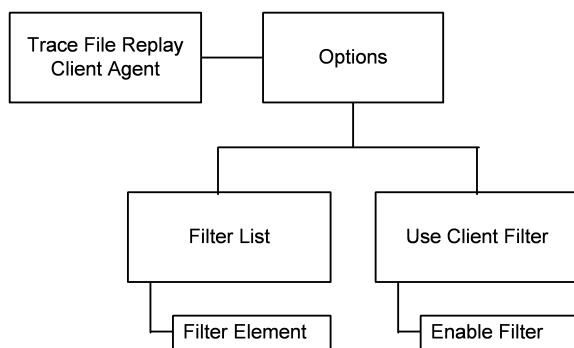

## Objectives

The objectives (userObjective) you can set for Trace File Replay are listed below. Test objectives are set in the ixTimeline object.

- simulatedUsers

## Trace File Replay Client Commands

This section lists the Trace File Replay client commands.

## Trace File Replay Client Agent

The Trace File Replay Client Agent command defines a client that will transmit a packet stream to a Trace File Replay Server Agent. Refer to `Trace File Replay Client Agent` on page 22-5 for a full description of this command. The most sigoptions of this command are listed below.

Option	Description
<code>enable</code>	Enables the use of this client agent.
<code>name</code>	The name associated with this object, which must be set at object creation time .
<code>protocol</code>	Protocol used by the client agent.
<code>type</code>	Defines the agent as either a client or server.

## Options

The Options command configures the Trace File Replay client's options. Refer to `Options` on page 22-7 for a full description of this command. The most signioptions of this command are listed below.

Option	Description
<code>destinationServerActivity</code>	Name of the IxLoad Trace File Replay server that the client will connect to.
<code>traceFileName</code>	Name and path of the pcap-format trace file that the client will use to generate the traffic stream.
<code>replayBidirectionalTraffic</code>	If <code>true</code> , the client uses the same trace (pcap) file as selected for the server agent.
<code>enableFilter</code>	If <code>true</code> , the filters in the client's <code>filterList</code> are applied to the incoming packet stream from the server.
<code>filterList</code>	List of filters applied to incoming packet stream.

## Filter List

The Filter List command configures a filter to be applied to the packet stream. Refer to `Filter List` on page 22-9 for a full description of this command. The most significant options of this command are

listed below.

Option	Description
protocol	Protocol to be filtered.
srcDest	Address type that <code>ipSubnet</code> applies to.
ipSubnet	IP address to be filtered.
prefixLength	Subnet mask applied to address to be filtered.
srcDestPort	Port type that <code>portNumber</code> applies to.
portNumber	Port number to be filtered.

## Trace File Replay Server Commands

The Trace File Replay Server API structure is shown below.

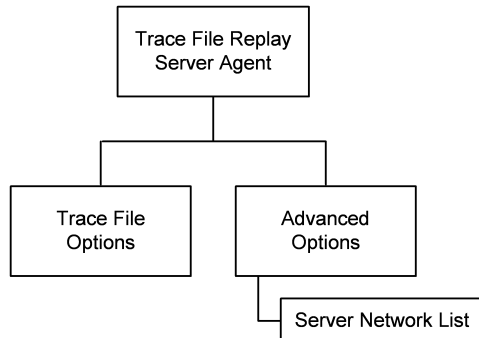

### Trace File Replay Server Agent

The Trace File Replay Server Agent command defines a server that transmits a packet stream to a Trace File Replay client. Refer to [Trace File Replay Client Agent](#) on page 22-5 for a full description of this command. The most significant options of this command listed below.

Option	Description
--------	-------------

enable	Enables the use of this client agent.
name	The name associated with this object, which must be set at object creation time .
protocol	Protocol used by the client agent.
type	Defines the agent as either a client or server.

## Trace File Options

The Trace File Options command configures the list of parameters for a Trace File Replay server. Refer to `Trace File Options` on page 22-13 for a full description of this command. The most significant options of this command are listed below.

Option	Description
sourceClientActivity	Name of the IxLoad Trace File Replay client that the server will connect to.
traceFileName	Name and path of the pcap-format trace file that the client will use to generate the traffic stream.
useDefaultTraceFile	If true, the client uses the same trace (pcap) file as selected for the server agent.
enableFilter	If true, the filters in the client's filterList are applied to the incoming packet stream from the server.
filterList	List of filters to be applied to the specified trace (pcap) file.

## Advanced Options

The Trace File Server Advanced Options command configures the advanced options for a Trace File Replay server. Refer to `Advanced Options` on page 22-14 for a full description of this command. The most significant options of this command are listed below.

Option	Description
serverNetworkList	List of IP addresses in the trace (pcap) file identified as server addresses.

---

useSpecifiedServerAddr	If <code>true</code> , the server scans the trace file and automatically determines which addresses are server addresses.
------------------------	---

## Server Network List

The `Server Network List` command configures the list of server IP addresses in the trace (pcap) file. Refer to `Server Network List` on page 22-15 for a full description of this command. The most significant options of this command are listed below.

Option	Description
<code>ipSubnet</code>	IP address identified as a server IP address.
<code>prefixLength</code>	Width of subnet mask applied to <code>subnetID</code> .

## Trace File Replay Client Agent

Trace File Replay Client Agent - create a Trace File Replay client

### SYNOPSIS

```
set Traffic1_Network1 [::IxLoad new ixNetTraffic]
set Activity_TraceFileReplClient1 [$Traffic1_Network1 activityList.appendItem
options...]
$Activity_TraceFileReplClient1 agent.config
```

### DESCRIPTION

A Trace File Replay client agent is added to the `activityList` object. The `activityL` object is added to the `ixNetTraffic` object using the `appendItem` subcommand from the `ixCon-`  
`figSequenceContainer` command.

### SUBCOMMANDS

The options for this command are configured and read using the standard `config`, `cget`, and `getOp-`  
`tions` subcommands defined in the `ixConfig` command.

### OPTIONS

`enable`

Enables the use of this client agent. (Default = true).

`name`

The name associated with this object, which must be set at object creation time.

### STATISTICS

### EXAMPLE

```
set Traffic1_Network1 [::IxLoad new
ixNetTraffic]##### Activity
TraceFileReplClient1 of NetTraffic
Traffic1@Network1#####set Activity_
TraceFileReplClient1 [$Traffic1_Network1 activityList.appendItem \-protocolAndType
"capturereplay Client" ]$Activity_TraceFileReplClient1 agent.config \-enable
true \-name "TraceFileReplClient1"
```

### SEE ALSO

[ixNetTraffic](#)

## Options

Options—Configures the list of parameters for a Trace File Replay client.

### SYNOPSIS

```
set Traffic1_Network1 [::IxLoad new ixNetTraffic]
set Activity_TraceFileReplClient1 [$Traffic1_Network1 activityList.appendItem
options...]
$Activity_TraceFileReplClient1 agent.pm.options.config
```

### DESCRIPTION

An option is added to the list of Options using the `appendItem` subcommand from the `ixConfigSequenceContainer` command.

### SUBCOMMANDS

The options for this command are configured and read using the standard `config`, `cget`, and `getOption` subcommands defined in the `ixConfig` command.

### OPTIONS

`destinationServerActivity`

Name of the IxLoad Trace File Replay server that the client will connect to. (Default = {}).

`traceFileName`

Name and path of the pcap-format trace file that the client will use to generate the traffic stream. (Default = {}).

`replayBidirectionalTraffic`

If `true`, the client uses the same trace (pcap) file as selected for the server agent. (Default = `true`).

`enableFilter`

If `true`, the filters in the client's `filterList` are applied to the incoming packet stream from the server.

`filterList`

List of filters to be applied to the specified trace (pcap) file. This is a list of `Filter List` objects. (Default = {}).

### EXAMPLE

```
$Activity_TraceFileReplClient1 agent.pm.options.config \-traceFileName
"" \-destinationServerActivity          "" \-serverAddrString
"" \-enableFilter                       false \-replayBidirectionalTraffic
true
```

**SEE ALSO**

[Trace File Replay Client Agent](#)



## Filter List

Filter List—Configures a filter to be applied to the packet stream.

### SYNOPSIS

```
set Traffic1_Network1 [::IxLoad new ixNetTraffic]
set Activity_TraceFileReplClient1 [$Traffic1_Network1 activityList.appendItem
options...]
$Activity_newClientActivity1 agent.pm.filterList.appendItem
```

### DESCRIPTION

The Filter List command configures a filter that can be applied to the incoming packet stream. This command is added to the list of Trace File Replay client agent object using the `appendItem` subcommand from the `ixConfigSequenceContainer` command.

### SUBCOMMANDS

The options for this command are configured and read using the standard `config`, `cget`, and `getOptions` subcommands defined in the `ixConfig` command.

### OPTIONS

`protocol`

Protocol to be filtered. The choices are:

- (default) TCP
- UDP
- ICMP
- Any

`srcDest`

Address type that `ipSubnet` applies to. The choices are:

- (default) Source
- Destination
- Both
- Any

`ipSubnet`

IP address to be filtered. This is one of the IP addresses contained within the trace file.

`prefixLength`

Subnet mask applied to address to be filtered. Packets matching the subnet mask will be accepted. The choices are "1" through "32." (Default = "24").

srcDestPort

Port type that portNumber applies to. The choices are:

- Source
- (default) Destination
- Any

portNumber

Port number to be filtered.

### EXAMPLE

```
$Activity_newClientActivity1 agent.pm.filterList2.appendItem \-id  
"FilterElement" \-ipSubnet "198.18.1.1" \-portNumber  
"33729" \-srcDestPort "Source" \-protocol  
"TCP" \-prefixLength "32" \-srcDest  
"Any"
```

## Enable Filter

Enable Filter—Enables the client’s list of filters to be applied to the incoming packet stream.

### SYNOPSIS

```
set Traffic1_Network1 [::IxLoad new ixNetTraffic]
set Activity_TraceFileReplClient1 [$Traffic1_Network1 activityList.appendItem
options...]
$Activity_TraceFileReplClient1 agent.pm.options.config
```

### DESCRIPTION

Enable Filter causes the Trace File Replay client to use the filters configured on the client to be applied to the trace (pcap) file configured for the Trace File Replay client. The Trace File Replay client can specify its filters only if the `useDefaultTraceFile` option is disabled.

This command is added to the list of Trace File Replay client agent object using the `appendItem` subcommand from the `ixConfigSequenceContainer` command.

### SUBCOMMANDS

The options for this command are configured and read using the standard `config`, `cget`, and `getOption` subcommands defined in the `ixConfig` command.

### OPTIONS

`enableFilter`

If `true`, the client applies the client-side filters to the incoming packet stream. (Default = 0).

### EXAMPLE

```
$Activity_TraceFileReplClient1 agent.pm.options.config \-enableFilter
true \
```

### SEE ALSO

[Options](#)

## Trace File Replay Server Agent

Trace File Replay Server Agent

### SYNOPSIS

```
set ServerTraffic1_ServerNetwork1 [::IxLoad new ixNetTraffic]
set Activity_newServerActivity1 [$ServerTraffic1_ServerNetwork1 activityLoption...]
$Activity_newServerActivity1 agent.config
```

### DESCRIPTION

A Trace File Replay server agent is added to the `activityList` object. The `activity` object is added to the `ixNetTraffic` object using the `appendItem` subcommand from the `ixConfigSequenceContainer` command.

### SUBCOMMANDS

The options for this command are configured and read using the standard `config`, `cget`, and `getOption` subcommands defined in the `ixConfig` command.

### OPTIONS

`enable`

Enables the use of this server agent. (Default = true).

`name`

The name associated with this object, which must be set at object creation time.

### STATISTICS

### EXAMPLE

```
set ServerTraffic1_ServerNetwork1 [::IxLoad new
ixNetTraffic]##### Activity newServer-
Activity1 of NetTraffic
ServerTraffic1@ServerNetwork1#####set
Activity_newServerActivity1 [$ServerTraffic1_ServerNetwork1 activityList.appendItem
\-protocolAndType "capturereplay Server" ]$Activity_
newServerActivity1 agent.config \-enable true \-
name "newServerActivity1"
```

### SEE ALSO

[ixNetTraffic](#)

## Trace File Options

Trace File Options—Configures the list of parameters for a Trace File Replay server.

### SYNOPSIS

```
set ServerTraffic1_ServerNetwork1 [::IxLoad new ixNetTraffic]
set Activity_newServerActivity1 [$ServerTraffic1_ServerNetwork1 activityLoption...]
$Activity_newServerActivity1 agent.pm.traceFileOptions.config
```

### DESCRIPTION

An option is added to the list of Options using the `appendItem` subcommand from the `ixConfigSequenceContainer` command.

### SUBCOMMANDS

The options for this command are configured and read using the standard `config`, `cget`, and `getOption` subcommands defined in the `ixConfig` command.

### OPTIONS

`sourceClientActivity`

Name of the IxLoad Trace File Replay client that the server will connect to.

`traceFileName`

Name and path of the pcap-format trace file that the server will use to generate the traffic stream. (Default = {}).

`enableFilter`

If `true`, the filters in the client's `filterList` are applied to the incoming packet stream from the server.

`filterList`

List of filters applied to incoming packet stream. This is a list of `Filter List` objects. (Default = {}).

### EXAMPLE

```
$Activity_newServerActivity1 agent.pm.traceFileOptions.config \
-enableFiltertrue \
-traceFileName"C:/Program Files/Ixia/IxLoad/ \
\Repository/Samples/TraceFileReplay/Captures/oracle1.cap" \
-clientAddrString"sym:newServerActivity1!ClientTraffic1_newClientActivity1" \
-sourceClientActivity"ClientTraffic1_newClientActivity1"
```

**SEE ALSO**

[Trace File Replay Server Agent](#)

## Server Network List

Server Network List—Lists of server IP addresses contained in trace (pcap) file.

### SYNOPSIS

```
set ServerTraffic1_ServerNetwork1 [::IxLoad new ixNetTraffic]
set Activity_newServerActivity1 [$ServerTraffic1_ServerNetwork1 activityLoption...]
$Activity_newServerActivity1 agent.pm.advancedOptions.serverNet
```

### DESCRIPTION

Server Network List is a list of IP addresses and subnet masks contained within the trace (pcap) file that are determined (either manually by the user/application or automatically by IxLoad) to be server addresses.

This command is added to the list of Trace File Replay server agent advancedOptions using the appendItem subcommand from the ixConfigSequenceContainer command.

### SUBCOMMANDS

The options for this command are configured and read using the standard config, cget, and getOptions subcommands defined in the ixConfig command.

### OPTIONS

ipSubnet

IP address identified as a server IP address.

prefixLength

Width of subnet mask applied to ipSubnet.

### EXAMPLE

```
$Activity_newServerActivity1 agent.pm.advancedOptions.serverNetworkList.appendItem
-id                               "Network" \-prefixLength
"32" \-ipSubnet                   "198.18.1.11"
```

### SEE ALSO

[Advanced Options](#)

## Advanced Options

Advanced Options—Configures the list of advanced options for a Trace File Replay server.

### SYNOPSIS

```
set ServerTraffic1_ServerNetwork1 [::IxLoad new ixNetTraffic]
set Activity_newServerActivity1 [$ServerTraffic1_ServerNetwork1 activityLoption...]
$Activity_newServerActivity1 agent.pm.advancedOptions.config
```

### DESCRIPTION

The Advanced Options command configures the global options of a Trace File Replay server. The command is configured using the `config` subcommand of the `ixConfig` command.

### SUBCOMMANDS

The options for this command are configured and read using the standard `config`, `cget`, and `getOption` subcommands defined in the `ixConfig` command.

### OPTIONS

`serverNetworkList`

List of IP addresses in the trace (pcap) file identified as server addresses. See `Server Network List`.

`useSpecifiedServerAddr`

If `true`, the server scans the trace file and automatically determines which addresses are server addresses. IxLoad adds the IP addresses to the `Server Network List`.

### EXAMPLE

```
$Activity_newServerActivity1 agent.pm.advancedOptions.config \-
useSpecifiedServerAddr           true
```

### SEE ALSO

[Trace File Replay Server Agent](#)

[Server Network List](#)



## Statistics

For Trace File Replay client statistics, see [Trace File Replay Client Statistics](#).

For Trace File Replay server statistics, see [Trace File Replay Server Statistics](#).

For TCP statistics, see [TCP, Run State, and Curve Segment Statistics](#).

## Trace File Replay Client Statistics

The following table describes the statistics for the Trace File Replay client.

Statistic	Description
Trace File Replay Client Initializing State	Number of users currently being initialized.
Trace File Replay Client Synchronizing State	Number of users currently awaiting synchronization.
Trace File Replay Client Active State	Number of users currently active.
TraceFileReplay Client Packets Sent	Number of packets sent by the Trace File Replay client.
TraceFileReplay Client TCP Packets Sent	Number of TCP packets sent by the Trace File Replay client.
TraceFileReplay Client UDP Packets Sent	Number of UDP packets sent by the Trace File Replay client.
TraceFileReplay Client ARP Packets Sent	Number of ARP packets sent by the Trace File Replay client.
TraceFileReplay Client ICMP Packets Sent	Number of ICMP packets sent by the Trace File Replay client.
TraceFileReplay Client Other Packets Sent	Number of packets sent by the Trace File Replay client that were not TCP, UDP, ARP, or ICMP packets.
TraceFileReplay Client Discarded Packets	Number packets discarded by the Trace File Replay client.
TraceFileReplay Client Bytes Sent	Number of bytes sent by the Trace File Replay client.
TraceFileReplay Client TCP Bytes Sent	Number of TCP bytes sent by the Trace File Replay client.
TraceFileReplay Client UDP Bytes Sent	Number of UDP bytes sent by the Trace File Replay client.
TraceFileReplay Client ARP Bytes Sent	Number of ARP bytes sent by the Trace File Replay client.

---

TraceFileReplay Client ICMP Bytes Sent	Number of ICMP bytes sent by the Trace File Replay client.
TraceFileReplay Client Other Bytes Sent	Number of bytes sent by the Trace File Replay client that were not TCP, UDP, ARP, or ICMP bytes.
TraceFileReplay Client Discarded Bytes	Number of bytes discarded by the Trace File Replay Client.

## Trace File Replay Server Statistics

The following table describes the statistics for the Trace File Replay server.

Statistic	Description
Trace File Replay Server Initializing State	Number of users currently being initialized.
Trace File Replay Server Synchronizing State	Number of users currently awaiting synchronization.
Trace File Replay Server Active State	Number of users currently active.
TraceFileReplay Server Packets Sent	Number of packets sent by the Trace File Replay server.
TraceFileReplay Server TCP Packets Sent	Number of TCP packets sent by the Trace File Replay server.
TraceFileReplay Server UDP Packets Sent	Number of UDP packets sent by the Trace File Replay server.
TraceFileReplay Server ARP Packets Sent	Number of ARP packets sent by the Trace File Replay server.
TraceFileReplay Server ICMP Packets Sent	Number of ICMP packets sent by the Trace File Replay server.
TraceFileReplay Server Other Packets Sent	Number of packets sent by the Trace File Replay server that were not TCP, UDP, ARP, or ICMP packets.
TraceFileReplay Server Discarded Packets	Number packets discarded by the Trace File Replay server.
TraceFileReplay Server Bytes Sent	Number of bytes sent by the Trace File Replay server.
TraceFileReplay Server TCP Bytes Sent	Number of TCP bytes sent by the Trace File Replay server.
TraceFileReplay Server UDP Bytes Sent	Number of UDP bytes sent by the Trace File Replay server.
TraceFileReplay Server ARP Bytes Sent	Number of ARP bytes sent by the Trace File Replay server.

---

TraceFileReplay Server ICMP Bytes Sent	Number of ICMP bytes sent by the Trace File Replay server.
TraceFileReplay Server Other Bytes Sent	Number of bytes sent by the Trace File Replay server that were not TCP, UDP, ARP, or ICMP bytes.
TraceFileReplay Server Discarded Bytes	Number of bytes discarded by the Trace File Replay server.

This page intentionally left blank.

## **VDI**

This section describes the VDI Tcl API objects.

### **API Overview**

The IxLoad VDI API consists of the VDI Client Agent and its commands.

## VDI Client Agent

VDI client agent - create a VDI/RDP client agent

### SYNOPSIS

```
set Activity_VDIclient1 [$Traffic1_Network1 activityList.appendItem \  
-protocolAndType          "rdp Client" ]
```

### DESCRIPTION

A VDI client agent is added to the `activityList` object. The `activityList` object is added to the `ixNetTraffic` object using the `appendItem` subcommand from the `ixConfigSequenceContainer` command.

### SUBCOMMANDS

None.

### OPTIONS

The options for this command are configured and read using the standard `config`, `cget`, and `getOption` subcommands defined in the `ixConfig` command.

### STATISTICS

### EXAMPLE

```
set Activity_VDIclient1 [$Traffic1_Network1 activityList.appendItem \  
-protocolAndType          "rdp Client" ]
```

### SEE ALSO

`ixNetTraffic`



## settings

settings - configure the settings of a VDI client agent

### SYNOPSIS

```
$Activity_VDIclient1 agent.pm.settings.config
```

### DESCRIPTION

This object configures the settings for a VDI client agent.

### SUBCOMMANDS

None.

### OPTIONS

```
resolutionH
```

Horizontal resolution. Default = 600.

```
encryption
```

Type of encryption. One of the following:

Choice	Description
0 (default)	Full encryption
1	Login encryption only
2	None

```
enableVDI
```

Enables use of a connection server. Default = false.

```
connectionServerPort
```

Connection server listening port. Default = 443.

```
connectionServer
```

Hostname or IP address of connection server. Default = "" (none)

```
depth
```

Color depth (number of bits per pixel) of remote desktop. Default = 8.

```
enableTunnel
```

Use secure tunnel to establish connection to remote desktop. Default = true.

desktopPool

Name of desktop pool. Default = "" (none).

credentialsFullPath

Path of credentials file. Default = "" (none).

resolutionW

Vertical resolution of remote desktop. Default = 800.

### EXAMPLE

```
$Activity_VDIclient1 agent.pm.settings.config \
```

```
-resolutionH          600 \  
-encryption           0 \  
-enableVDI            false \  
-connectionServerPort 443 \  
-connectionServer     "" \  
-depth                8 \  
-enableTunnel          true \  
-desktopPool          "" \  
-credentialsFullPath  "" \  
-resolutionW          800
```

### SEE ALSO

`ixNetTraffic`

## VDI Client Commands

This section lists the VDI client agent's commands.

## VoIP H.248 Peer

The IxLoad VoIP H.248 Peer Tcl API consists of a VoIP MGW and VOIP MGC Peer agent, with separate APIs for configuring each major aspect of the agent's functionality.

There is also a TermGroup Agent with separate configuration parameters.

- When defined on a MGW activity, a TermGroup refers to terminations present on that gateway.
- When defined on a MGC activity, a TermGroup refers to terminations managed by that controller.

## Limitations

The following restrictions and limitations of the VoIP H.248 Peer API exist:

- Individual VoIP H248 script functions can not be added and edited from the Tcl API. Instead, you must add and configure the test scenario in the Scenario Editor, then save the test scenario file and pass it as an argument to the `ScenarioSettings` API class.

## VoIP H248 Peer API Commands

The IxLoad VoIP H248 Peer API commands are organized as shown in the figures below.

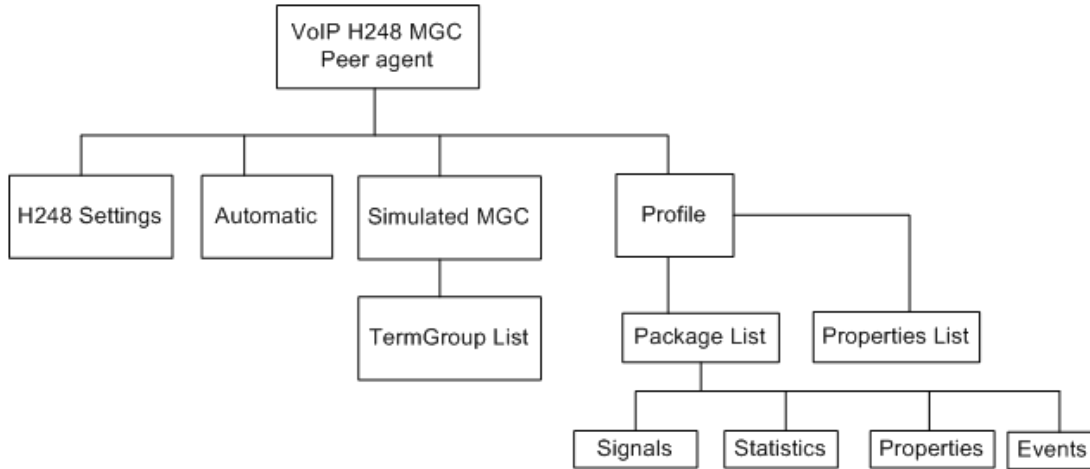

VoIP H248 MGW Peer API Structure

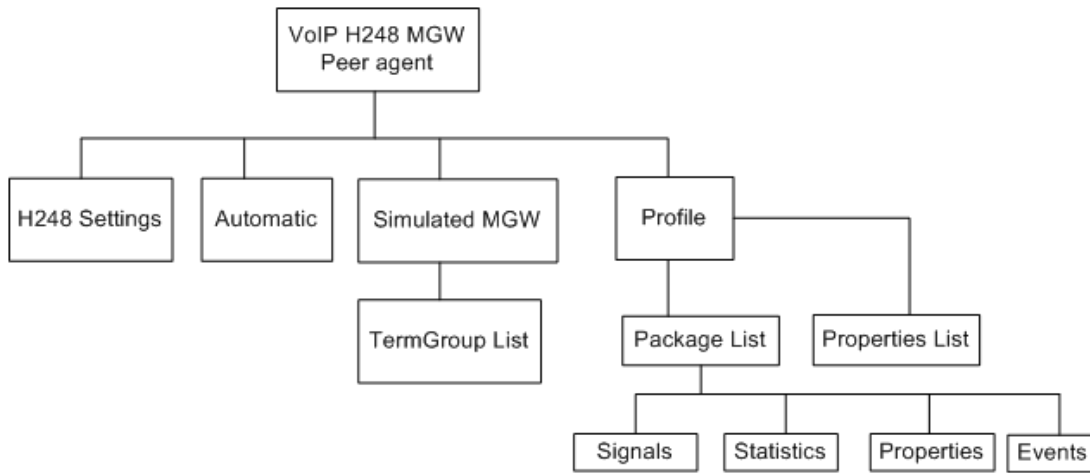

VoIP H248 Term Group API Structure

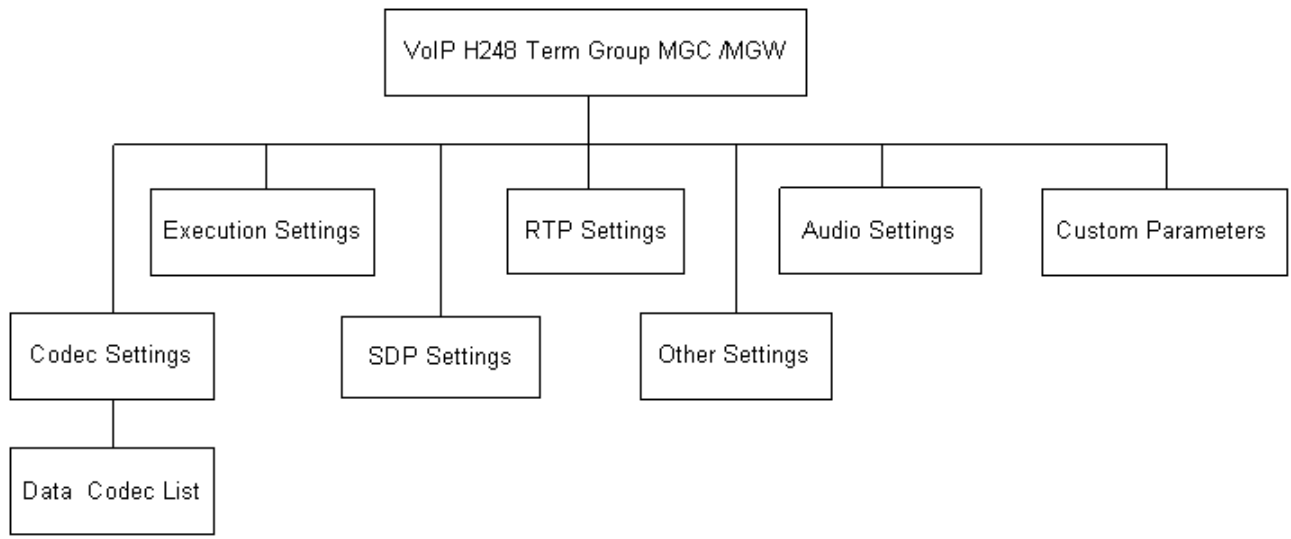

## VoIP H248 MGC/MGW Peer API Objects

The following table summarizes the VoIP H248 MGC/MGW Peer API Objects

Object	Description
VoIP H248 Peer Agent	Top-level object defining the VoIP H248 Peer activity.
H248 Settings	Configures the H.248 Settings separately for the Media Gateway or Media Controller.
Automatic	Sets the automatic functionality parameters for the MGC and MGW side.
SimulatedMGC / MGW	Simulates the source address in H.248 messages, designates the simulation type, and so on. Also contains the list of all termination groups associated with the gateway or controller.
TermGroups	Contains the list of all termination groups associated with the gateway or controller. Each termination groups has a name and two expressions to generate termination names. When a new TermGroup is added, a new activity is added in the same NetTraffic.
Profiles	A collection of packages where each package is a collection of events, signals, statistics, properties, and procedures. During registration, an MGW declares a supported profile and MGC sends audit commands to find the packages that are supported by a particular profile. The profile selected in Profiles depends on the SimulatedMGW type declared in SimulatedMGW/MGC.
Packages	A collection of events, signals, statistics, properties, and procedures.
Properties	H.248 has two basic components: Terminations and Contexts. Terminations have properties, which can be inspected and modified by the MGC.
Signals	Represents the signals of a transmission.
Statistics	Represents the statistics available for MGC and MGW.
Events	Represents the events of a transmission.

## VoIP H248 TermGroup Peer API Objects

The following table summarizes the VoIP H248 TermGroup API Objects

Object	Description
VoIP H248 MGC/MGW TermGroup Agent	Top-level object defining the VoIP H248 MGC/MGW TermGroup agent activity.
Scenario Settings	Selects the Test Scenario file; corresponds to the Scenario Settings GUI tab.
Codec Settings	List of <code>Data Codecs</code> and <code>Codecs</code> objects.
Data Codecs	Data codec with parameters.
Codecs	Audio codec with parameters.
Other Settings	VoIP H323 Peer miscellaneous parameters; corresponds to the Other Settings GUI tab.
SDP Settings	H.248 uses SDP for specification and negotiation of media capabilities of GW terminations. SDP information is sent using a Stream descriptor that specifies as a single bi-directional media stream.
RTP Settings	RTP transport configuration; corresponds to the RTP Settings GUI tab.
Audio Settings	Audio settings; corresponds to the Audio GUI tab.
Custom Activity Link Settings, CustomParameters	BHCA objective configuration; corresponds to the Custom Parameters GUI tab.
Execution Settings	Run-time test configuration; corresponds to the Execution Settings GUI tab.

## VoIP H248 Peer Agent

VoIP H248MGW or H248MGC Peer Agent

### SYNOPSIS

```
set Activity_H248MGC1 [$Traffic1_Network1 activityList.appendItem \-protocolAndType  
"H248MGC Peer" ]
```

### DESCRIPTION

A VoIP H.248 Peer agent is added to the `agentList` option of the `ixConfig` object using the `appendItem` subcommand from the `ixConfigSequenceContainer` command. Other `ixConfigSequenceContainer` subcommands may be used to modify the `agentList`. See the following example:

```
set Activity_H248MGC1 [$Traffic1_Network1 activityList.appendItem \-protocolAndType  
"H248MGC Peer" ]
```

```
$Activity_H248MGC1 config \-enable 1 \-name  
"H248MGC1"
```

```
$Activity_H248MGC1 agent.config \-enable 1 \-name  
"H248MGC1" \-uniqueID 1
```

Each member of the list, however may be separately addressed and modified using the `ixConfig` subcommands. For example, the first agent uses an index of 0 and its name may be modified by:

```
$Activity_H248MGC1 agent(0).config -name "H248MGC Peer new"
```

### SUBCOMMANDS

None.

### OPTIONS

`enable`

Enables the use of this agent. (Default = true).

`name`

The name associated with this object, which must be set at object creation time.

`uniqueID`

The unique ID of this object. (Default = 1)

### STATISTICS

The available H248/MEGACO statistics are listed in below:



Statistic	Description	
<b>H.248 MGC Transport</b>		
Bytes Sent	The number of bytes sent by MGC.	
Bytes Received	The number of bytes received by MGC.	
Messages Sent	The number of messages sent by MGC.	
Messages Received	The number of messages received by MGC.	
Avg Sent/Received Message Size	The average sent/received messages size by MGC.	
<b>H.248 MGC Transactions</b>		
Transaction Requests Sent	The number of transaction requests sent by MGC.	
Transaction Requests Received	The number of transaction requests received by MGC.	
Transaction Replies Sent	The number of transaction replies sent by MGC.	
Transaction Replies Received	The number of transaction replies received by MGC.	
Transaction Pending Sent	The number of 'Transaction pending' responses sent by MGC.	
Transaction Pending Received	The number of 'Transaction pending' responses received by MGC.	
Transaction Response Ack Sent	The number of Ack transaction responses sent by MGC.	
Transaction Response Ack Received	The number of Ack transaction responses received by MGC.	
<b>H.248 MGC Retransmissions</b>		
Retransmitted Transaction Requests Sent	The number of retransmitted transaction requests sent.	
Retransmitted Transaction Requests Received	The number of retransmitted transaction requests received.	
Retransmitted Transaction Replies Sent	The number of retransmitted transaction replies sent.	

Retransmitted Transaction Replies Received	The number of retransmitted transaction replies received.	
<b>H.248 MGC Commands</b>		
Add command requests sent	The number of Add command requests sent by MGC.	
Add command replies received	The number of Add command replies received by MGC.	
Modify command requests sent	The number of Modify command requests sent by MGC.	
Modify command replies received	The number of Modify command replies received by MGC.	
Move command requests sent	The number of Move command requests sent by MGC.	
Move command replies received	The number of Move command replies received by MGC.	
Subtract command requests sent	The number of Move command requests sent by MGC.	
Subtract command replies received	The number of Move command replies received by MGC.	
AuditValue command requests sent	The number of AuditValue command requests sent by MGC.	
AuditValue command replies received	The number of AuditValue command replies received by MGC.	
AuditCapability command requests sent	The number of AuditCapability command requests sent by MGC.	
AuditCapability command replies received	The number of AuditCapability command replies received by MGC.	
ServiceChange command requests sent	The number of ServiceChange command requests sent by MGC.	
ServiceChange command requests received	The number of ServiceChange command requests received by MGC.	
ServiceChange command replies sent	The number of ServiceChange command replies sent by MGC.	

ServiceChange command replies received	The number of ServiceChange command replies received by MGC.	
Notify command requests received	The number of Notify command requests received by MGC.	
Notify command replies sent	The number of Notify command replies sent by MGC.	
<b>H.248 MGC Protocol Errors</b>		
4xx Errors	The number of 4xx error messages sent and received by MGC.	
5xx Errors	The number of 5xx error messages sent and received by MGC.	
<b>H.248 MGC Errors</b>		
Transport Errors	The number of transport protocol errors.	
SDP Errors	The number of SDP errors.	
Parser Errors	The number of parser errors.	
<b>H.248 MGC Received Requests/Replies</b>		
Transactions Not Matched	The number of transactions not matched.	
Transactions Matched	The number of transactions matched.	
Discarded Transactions	The number of discarded transactions.	
Processed Transactions	The number of processed transactions.	
Auto Processed Transactions	The number of automatically processed transactions.	
<b>H.248 MGW Transport</b>		
Bytes Sent	The number of bytes sent by MGW.	
Bytes Received	The number of bytes received by MGW.	
Messages Sent	The number of messages sent by MGW.	
Messages Received	The number of messages received by MGW.	
Avg Sent/Received Message Size	The average sent/received messages size by MGW.	
<b>H.248 MGW Transactions</b>		

Transaction Requests Sent	The number of transaction requests sent by MGW.	
Transaction Requests Received	The number of transaction requests received by MGW.	
Transaction Replies Sent	The number of transaction replies sent by MGW.	
Transaction Replies Received	The number of transaction replies received by MGW.	
Transaction Pending Sent	The number of 'Transaction pending' responses sent by MGW.	
Transaction Pending Received	The number of 'Transaction pending' responses received by MGW.	
Transaction Response Ack Sent	The number of Ack transaction responses sent by MGW.	
Transaction Response Ack Received	The number of Ack transaction responses received by MGW.	
<b>H.248 MGW Retransmissions</b>		
Retransmitted Transaction Requests Sent	The number of retransmitted transaction requests sent.	
Retransmitted Transaction Requests Received	The number of retransmitted transaction requests received.	
Retransmitted Transaction Replies Sent	The number of retransmitted transaction replies sent.	
Retransmitted Transaction Replies Received	The number of retransmitted transaction replies received.	
<b>H.248 MGW Commands</b>		
Add command requests received	The number of Add command requests received by MGW.	
Add command replies sent	The number of Add command replies sent by MGW.	
Modify command requests received	The number of Modify command requests received by MGW.	
Modify command replies sent	The number of Modify command replies sent by MGW.	

Move command requests received	The number of Move command requests received by MGW.	
Move command replies sent	The number of Move command replies sent by MGW.	
Subtract command requests received	The number of Move command requests received by MGW.	
Subtract command replies sent	The number of Move command replies sent by MGW.	
AuditValue command requests received	The number of AuditValue command requests received by MGW.	
AuditValue command replies sent	The number of AuditValue command replies sent by MGW.	
AuditCapability command requests received	The number of AuditCapability command requests received by MGW.	
AuditCapability command replies sent	The number of AuditCapability command replies sent by MGW.	
ServiceChange command requests sent	The number of ServiceChange command requests sent by MGW.	
ServiceChange command requests received	The number of ServiceChange command requests received by MGW.	
ServiceChange command replies sent	The number of ServiceChange command replies sent by MGW.	
ServiceChange command replies received	The number of ServiceChange command replies received by MGW.	
Notify command requests sent	The number of Notify command requests received by MGW.	
Notify command replies received	The number of Notify command replies sent by MGW.	
<b>H.248 MGW Protocol Errors</b>		
4xx Errors	The number of 4xx error messages sent and received by MGW.	
5xx Errors	The number of 5xx error messages sent and received by MGW.	
<b>H.248 MGW Errors</b>		

Transport Errors	The number of transport protocol errors.	
SDP Errors	The number of SDP errors.	
Parser Errors	The number of parser errors.	
<b>H.248 MGW Received Requests/Replies</b>		
Transactions Not Matched	The number of transactions not matched.	
Transactions Matched	The number of transactions matched.	
Discarded Transactions	The number of discarded transactions.	
Processed Transactions	The number of processed transactions.	
Auto Processed Transactions	The number of automatically processed transactions.	
<b>H.248 Loop Rate</b>		
Loops-per-second	The per polling interval loops-per-second value.	Global

**EXAMPLE**

```
##### Activity H248MGC1 of NetTraffic
Traffic1@Network1#####set Activity_
H248MGC1 [$Traffic1_Network1 activityList.appendItem \-protocolAndType
"H248MGC Peer" ]
```

```
$Activity_H248MGC1 config \-enable 1 \-name
"H248MGC1"
```

```
$Activity_H248MGC1 agent.config \-enable 1 \-name
"H248MGC1" \-uniqueID 1
```

**SEE ALSO**

[ixConfig](#)

## Simulated MGC

VoIP H248 Simulated MGC settings

### SYNOPSIS

```
set Activity_H248MGC1 [$Traffic1_Network1 activityList.appendItem \-protocolAndType
"H248MGC Peer" ]$Activity_H248MGC1 agent.config$Activity_H248MGC1 agent.p-
m.simulatedMGC.config
```

### DESCRIPTION

Simulates the source address in H.248 messages, designates the simulation type, and so on. Also contains the list of all termination groups associated with the gateway or controller.

### SUBCOMMANDS

None.

### OPTIONS

The options for this command are configured and read using the standard `config`, `cget`, and `getOption` subcommands defined in the `ixConfig` command.

`sourcePort`

Indicates the port number of the source address. Default = "2944"

`mgcName`

Indicates the device name or DNS name. It is not used when MID format is IP Address or IP Address:port.

**NOTE:** Sequence generator expressions are also supported, for example, `MEGACOCA|00-|`.

`controlledGWType`

Indicates the gateway types. The types are:

- Border Gateway (IP2IP)
- Trunking Gateway (PSTN2IP)
- Residential Gateway (PSTN2IP)
- Access Gateway (PSTN2IP)

`mid`

Indicates the format of the source address in H.248 messages. The options are:

- IP Address
- IP Address:port
- Device Name
- MGC DNS Name

- MGC DNS Name:port

**EXAMPLE**

```
set Activity_H248MGC1 [$Traffic1_Network1 activityList.appendItem \-protocolAndType  
"H248MGC Peer" ]
```

```
$Activity_H248MGC1 config \-enable 1 \-name  
"H248MGC1"
```

```
$Activity_H248MGC1 agent.config \-enable 1 \-name  
"H248MGC1" \-uniqueID 1
```

```
$Activity_H248MGC1 agent.pm.simulatedMGC.config \-sourcePort  
"2944" \-mgcName "MEGACOCA\[00-\]" \-  
controlledGWType 1 \-mid  
1
```

```
$Activity_H248MGC1 agent.pm.simulatedMGC.termGroups.clear
```

**SEE ALSO**

[VoIP H248 Peer Agent](#)



## Simulated MGW

VoIP H248 Simulated MGW settings

### SYNOPSIS

```
set Activity_H248MGW1 [$Traffic1_Network1 activityList.appendItem \-protocolAndType
"H248MGW Peer" ]$Activity_H248MGW1 agent.config$Activity_H248MGW1 agent.p-
m.simulatedMGW.config
```

### DESCRIPTION

Simulates the source address in H.248 messages, designates the simulation type, and so on. Also contains the list of all termination groups associated with the gateway.

### SUBCOMMANDS

None.

### OPTIONS

The options for this command are configured and read using the standard `config`, `cget`, and `getOption` subcommands defined in the `ixConfig` command.

`sourcePort`

Indicates the port number of the source address. Default = "2944"

`gwName`

Indicates the device name or DNS name. It is not used when MID format is IP Address or IP Address:-port.

**NOTE:** Sequence generator expressions are also supported, for example, MEGACOCA|00-|.

`simulatedType`

Indicates the gateway types. The types are:

- Border Gateway (IP2IP)
- Trunking Gateway (PSTN2IP)
- Residential Gateway (PSTN2IP)
- Access Gateway (PSTN2IP)

`dest`

The address of the controlling MGC, specified as an activity name or an IP address, followed by a port number.

`mid`

Indicates the format of the source address in H.248 messages. The format options are:

- IP Address
- IP Address:port
- Device Name
- GW DNS Name
- GW DNS Name:port

### EXAMPLE

```
$Activity_H248MGW1 agent.pm.simulatedMGW.config \
```

```
-sourcePort      "2944" \  
-gwName          "MEGACOGW|00-|" \  
-simulatedType   1 \  
-dest            "Traffic1_H248MGC1:2944" \  
-mid             1
```

```
$Activity_H248MGW1 agent.pm.simulatedMGW.termGroups.clear
```

### SEE ALSO

[VoIP H248 Peer Agent](#)

## H248 TermGroups

VoIP H248 MGW/MGC TermGroup settings

### SYNOPSIS

```
H248 MGW TermGroupset Activity_H248MGW1 [$Traffic2_Network2 activityList.appendItem
\ -protocolAndType "H248MGW Peer" ]$Activity_H248MGW1 agent.-
config \ $Activity_H248MGW1 agent.pm.simulatedMGW.termGroups.appendItem\
```

```
H248 MGC TermGroupset Activity_H248MGC1 [$Traffic2_Network2 activityList.appendItem
\ -protocolAndType "H248MGC Peer" ]$Activity_H248MGC1 agent.-
config \ $Activity_H248MGC1 agent.pm.simulatedMGC.termGroups.appendItem\
```

### DESCRIPTION

The list of all termination groups associated with the selected gateway or controller type.

### SUBCOMMANDS

None.

### OPTIONS

The options for this command are configured and read using the standard `config`, `cget`, and `getOption` subcommands defined in the `ixConfig` command.

`enabled`

If `true`, the term group is enabled. Default=`false`

`id`

Indicates the term group identification ID. Default=`TermGroup`

`name`

Indicates the name of the term group. For example: `"H248TermGroupMGC1" \`

`physicalId`

The physical identification of the term group. If a message with termination name `$` and without a physical name is received, the message can not be handled.

`mgw`

Indicates the media gateway.

`rootTermination`

Enables a request that is addressed to the ROOT termination. The request may be processed only by an user from a Termination Group marked as Root in the SimulatedMGC/MGW. Default = 0

`rtpId1`

The RTP termination ID.

```
rtpId2
```

The second RTP termination ID.

### EXAMPLE

```
$Activity_H248MGC1 agent.pm.simulatedMGC.termGroups.appendItem \-id  
"TermGroup" \-name "H248TermGroupMGC1" \-  
physicalId "tdm/s_0/e1_{000-}/{00-29}" \-enabled  
true \-mgw "Traffic2_H248MGW1:2944" \-  
rootTermination 0 \-rtpId1  
"Ephemeral/0/0/[00000-]" \-rtpId2 ""
```

### SEE ALSO

[Simulated MGW](#)

[Simulated MGC](#)

## MGW Automatic

VoIP H248 MGW Automatic settings

### SYNOPSIS

```
H248 MGW Automaticset Activity_H248MGW1 [$Traffic2_Network2 activityList.appendItem
\ -protocolAndType "H248MGW Peer" ]$Activity_H248MGW1 agent.-
config \ $Activity_H248MGW1 agent.pm.automatic.config \
```

### DESCRIPTION

Automatic Settings specifies the automatic functionality parameters for the MGW side.

### SUBCOMMANDS

None.

### OPTIONS

The options for this command are configured and read using the standard `config`, `cget`, and `getOption` subcommands defined in the `ixConfig` command.

`autoReplyServiceChange`

If `true`, enables auto reply for Service Change. In this condition, Service Change requests are not dispatched to TermGroup users. `Default=false`.

`autoReplyAuditRequests`

If `true`, auto reply for Audit requests are not dispatched to TermGroup users.

**Note:** If a TermGroup associated with this MGW has `WaitAuditVal` or `WaitAuditCap` in scenario, the functions end with a Timeout status.

`sendTransAck`

If `true`, enables sending of Transaction Acknowledgement. In the enabled state, Ack is sent after each reply is received, and a Transaction Ack is expected after each reply sent. `Default=false`.

`sendTransPend`

If `true`, enables sending of TransactionPending reply. TransactionPending is sent when a TransactionRequest is received. The request is a retransmission. `Default=false`.

`autoReplyModifyOnRoot`

If `true`, Modify requests with Termination ROOT are not dispatched to TermGroup users.

**Note:** If a TermGroup associated with ROOT on this MGW has `WaitModify` in scenario, the function ends with a Timeout status.

`sendModifyOnRoot`

If `true`, Modify requests with Termination ROOT are not dispatched to TermGroup users. Default=`false`.

`enableRetransmissions`

If `true`, enables retransmissions of messages for which a response has not been received. Default=`false`

`maxRetransmissions`

When `enableRetransmissions` is configured `true`, this is the maximum number of retransmissions. Default=`1`

`retransmissionInterval`

When `enableRetransmissions` is configured `true`, this is the time in milliseconds for the first retransmission. Default=`10`

`commonDigitMap`

If `true`, the Gateway uses a specified default digit map. Default=`false`.

`digitMapName`

When `commonDigitMap` is `true`, this specifies the name of the default digit map. Default=`"dgmap"`

`digitMapValue`

When `commonDigitMap` is `true`, this specifies the value of the default digit map. Default=`"1234567890"`

`startWithRestart`

If `true`, the simulated MGW automatically registers with the MGC.

**Note:** Retransmissions for each transaction are not counted.

`retryCount`

Indicates the number of transactions with ServiceChange(Restart) generated.

**Note:** Retransmissions for each transactions are not counted.

`timeoutBetweenRetries`

Indicates the time between two transactions with ServiceChange(Restart) generated.

`maxInactivityTime`

The maximum inactivity time, after which an `Inactivity` event is generated.

#### EXAMPLE

```
$Activity_H248MGW1 agent.pm.automatic.config \-enableRetransmissions
false \-_gbCommonDigitMap                false \-maxInactivityTime
0 \-startWithRestart                      true \-sendTransPend
false \-commonDigitMap                    false \-retransmissionInterval
```

```
10 \-autoReplyToModifyOnRoot          true \-digitMapName
"" \-digitMapValue                    "" \-autoReplyServiceChange
false \-sendTransAck                  false \-autoReplyAuditRequests
false \-retryCount                    5 \-timeoutBetweenRetries
5 \-maxRetransmissions                1
```

**SEE ALSO**

[VoIP H248 Peer Agent](#)

## MGC Automatic

VoIP H248 MGC Automatic settings

### SYNOPSIS

```
H248 MGC Automaticset Activity_H248MGC1 [$Traffic2_Network2 activityList.appendItem
\ -protocolAndType "H248MGC Peer" ]$Activity_H248MGC1 agent.-
config \ $Activity_H248MGC1 agent.pm.automatic.config \
```

### DESCRIPTION

Automatic Settings specifies the automatic functionality parameters for the MGC side.

### SUBCOMMANDS

None.

### OPTIONS

The options for this command are configured and read using the standard `config`, `cget`, and `getOption` subcommands defined in the `ixConfig` command.

`autoReplyService`  
Change

If `true`, enables auto reply for Service Change. In this condition, Service Change requests are not dispatched to TermGroup users. `Default=false`.

`autoReplyNotify`

If `true`, enables auto reply for Notify. `Default=false`.

`sendModifyOnRoot`

If `true`, Modify requests with Termination ROOT are not dispatched to TermGroup users. `Default=false`

`sendTransAck`

If `true`, enables sending of Transaction Acknowledgement. In the enabled state, Ack is sent after each reply is received, and a Transaction Ack is expected after each reply sent. `Default=false`.

`sendTransPend`

If `true`, enables sending of TransactionPending reply. TransactionPending is sent when a TransactionRequest is received. The request is a retransmission. `Default=false`.

`enableRetransmissions`

If `true`, enables retransmissions of messages for which a response has not been received. `Default=false`

`retransmissionInterval`



If `enableRetransmissions` is `true`, this specifies the time in milliseconds for the first retransmission.  
Default=10

`maxRetransmissions`

If **`enableRetransmissions`** is `true`, this specifies the maximum number of retransmissions.  
Default=1

`waitRestart`

If `true`, enables the restart procedure. Default=`true`.

`timeoutForRestart`

If **`waitRestart`** is `true`, this indicates the time before restart. Default=0

`auditValue`

If `true`, sends an `AuditValue` request with the specified context, termination, and descriptors specified.  
Default=`false`.

`auditContextVal`

When **`auditValue`** is `true`, this specifies the context ID to which the `AuditValue` request is sent.  
Default="`-`".

`auditTerminationVal`

When **`auditValue`** is `true`, this specifies the termination ID to which the `AuditValue` request is sent.  
Default="`ROOT`"

`digitMapVal`

If `true`, includes the descriptor in the request. Default=`false`

`eventsVal`

If `true`, includes the descriptor in the request. Default=`false`

`eventBufferVal`

If `true`, includes the descriptor in the request. Default=`false`

`mediaVal`

If `true`, includes the descriptor in the request. Default=`false`

`modemVal`

If `true`, includes the descriptor in the request. Default=`false`

`multiplexerVal`

If `true`, includes the descriptor in the request. Default=`false`

`observedEventsVal`

If true, includes the descriptor in the request. Default=false

packagesVal

If true, includes the descriptor in the request. Default=true

statisticsVal

If true, includes the descriptor in the request. Default=false

signalsVal

If true, includes the descriptor in the request. Default=false

auditCapabilities

**If true, sends an AuditCapabilities request with context, termination, and descriptors as specified. Default=false**

auditContextCap

When **auditCapabilities** is true, this specifies the context ID to which the AuditCapabilities request is sent. Default="-"

auditTerminationCap

When **auditCapabilities** is true, this specifies the termination ID to which the AuditCapabilities request is sent. Default="ROOT"

digitMapVal

If true, includes the descriptor in the request. Default=false.

eventsCap

If true, includes the descriptor in the request. Default=false.

eventBufferCap

If true, includes the descriptor in the request. Default=false

mediaCap

If true, includes the descriptor in the request. Default=false

modemCap

If true, includes the descriptor in the request. Default=false

multiplexerCap

If true, includes the descriptor in the request. Default=false

observedEventsCap

If true, includes the descriptor in the request. Default=false

statisticsCap

If true, includes the descriptor in the request. Default=false

signalsCap

If true, includes the descriptor in the request. Default=false.

digitMapPerMGW

If true, sets a default DigitMap for the gateway. Default=false.

digitMapName

When **digitMapPerGW** is true, this specifies the name of the default Digit Map. Default="dgmap".

digitMapValue

When **digitMapPerGW** is true, this specifies the value of the default digit map. Default="1234567890".

enableKeepAlive

If true, activates the MGC keepalive mechanism by sending an inactivity timeout parameter to the GW. Default=false.

maxInactivityTime

If the Inactivity Timer Package is selected and the `enableKeepAlive` option is enabled, the configured timeout value value is sent to the GW. Default=10000.

## EXAMPLE

```
$Activity_H248MGC1 agent.pm.automatic.config \-enableKeepAlive
false \-signalsCap                false \-eventBufferVal
false \-sendTransPend             false \-modemVal
false \-digitMapName              "dgmap" \-autoReplyNotify
false \-multiplexerVal           false \-eventsVal
false \-auditTerminationCap      "ROOT" \-timeoutForRestart
0 \-packagesVal                  true \-mediaCap
false \-statisticsCap            false \-autoReplyServiceChange
false \-auditTerminationVal      "ROOT" \-auditCapabilities
false \-sendTransAck             false \-observedEventsCap
false \-maxRetransmissions       1 \-auditValue
false \-digitMapPerMGW          false \-maxInactivityTime
10000 \-signalsVal              false \-auditContextVal
 "-" \-statisticsVal             false \-digitMapValue
"1234567890" \-eventsCap         false \-sendModifyOnRoot
false \-enableRetransmissions    false \-mediaVal
false \-retransmissionInterval   10 \-modemCap
false \-eventBufferCap           false \-observedEventsVal
false \-digitMapVal             false \-waitRestart
true \-auditContextCap          "-" \-multiplexerCap
```

false

**SEE ALSO**

[VoIP H248 Peer Agent](#)

## Profiles

### VoIP H248 MGC/MGW Profiles Settings

#### SYNOPSIS

```
MGC Profileset Activity_H248MGC1 [$Traffic2_Network2 activityList.appendItem \-
protocolAndType                "H248MGC Peer" ]$Activity_H248MGC1 agent.-
config \ $Activity_H248MGC1 agent.pm.profiles.config \MGW Profileset Activity_
H248MGW1 [$Traffic2_Network2 activityList.appendItem \-protocolAndType
"H248MGW Peer" ]$Activity_H248MGW1 agent.config \ $Activity_H248MGW1 agent.p-
m.profiles.config \
```

#### DESCRIPTION

A collection of packages where each package is a collection of events, signals, statistics, properties, and procedures.

#### SUBCOMMANDS

None.

#### OPTIONS

The options for this command are configured and read using the standard `config`, `cget`, and `getOption` subcommands defined in the `ixConfig` command.

`profile`

The name of the profile. Default="ETSI\_TGW/1"

#### EXAMPLE

```
$Activity_H248MGC1 agent.pm.profiles.config \-profile
"ETSI_TGW/1"
```

#### SEE ALSO

[VoIP H248 Peer Agent](#)

## Packages

### VoIP H248 MGC/MGW Packages

#### SYNOPSIS

```
MGC Packageset Activity_H248MGC1 [$Traffic2_Network2 activityList.appendItem \-
protocolAndType                "H248MGC Peer" ]$Activity_H248MGC1 agent.-
config \ $Activity_H248MGC1 agent.pm.profiles.config \ $Activity_H248MGC1 agent.p-
m.profiles.packages.appendItemMGW Packageset Activity_H248MGW1 [$Traffic2_Network2
activityList.appendItem \-protocolAndType                "H248MGW Peer"
] $Activity_H248MGW1 agent.config \ $Activity_H248MGW1 agent.pm.profiles.config
\ $Activity_H248MGW1 agent.pm.profiles.packages.appendItem
```

#### DESCRIPTION

A collection of events, signals, statistics, properties, and procedures.

#### SUBCOMMANDS

None.

#### OPTIONS

The options for this command are configured and read using the standard `config`, `cget`, and `getOption` subcommands defined in the `ixConfig` command.

`id`

Shows the package type and package description of the supported packages for a particular profile type. Default="Package"

`supported`

Indicates the packages supported by the selected profile.

**NOTE:** The is editable when a custom profile is selected.

`hexid`

Indicates the hexadecimal id. Default=1

`version`

Indicates the protocol version. Allowed values are 1, 2, or 3. Default=2

#### EXAMPLE

```
$Activity_H248MGC1 agent.pm.profiles.packages.appendItem \-id
"Package" \-supported                0 \-hexid
1 \-version                          2
```

**SEE ALSO**

[Profiles](#)

## Events

### VoIP H248 MGC/MGW Events

#### SYNOPSIS

```
MGC Packageset Activity_H248MGC1 [$Traffic2_Network2 activityList.appendItem \-
protocolAndType                "H248MGC Peer" ]$Activity_H248MGC1 agent.-
config \ $Activity_H248MGC1 agent.pm.profiles.config \ $Activity_H248MGC1 agent.p-
m.profiles.packages.appendItem$Activity_H248MGC1 agent.pm.profiles.packages
(0).events.appendItem \MGW Packageset Activity_H248MGW1 [$Traffic2_Network2 activ-
ityList.appendItem \-protocolAndType                "H248MGW Peer" ]$Activ-
ity_H248MGW1 agent.config \ $Activity_H248MGW1 agent.pm.profiles.config \ $Activity_
H248MGW1 agent.pm.profiles.packages.appendItem$Activity_H248MGW1 agent.p-
m.profiles.packages(0).events.appendItem \
```

#### DESCRIPTION

Configures a collection of events.

#### SUBCOMMANDS

None.

#### OPTIONS

The options for this command are configured and read using the standard `config`, `cget`, and `getOption` subcommands defined in the `ixConfig` command.

`id`

Indicates the identification for events. Default="CID"

`hexid`

Indicates the hexadecimal id. Default=1

#### EXAMPLE

```
$Activity_H248MGC1 agent.pm.profiles.packages(1).events.appendItem \-id
"CID" \-hexid                1
```

#### SEE ALSO

[Packages](#)



## Properties

### VoIP H248 MGC/MGW Properties

#### SYNOPSIS

```
MGC Packageset Activity_H248MGC1 [$Traffic2_Network2 activityList.appendItem \-
protocolAndType "H248MGC Peer" ]$Activity_H248MGC1 agent.-
config \"$Activity_H248MGC1 agent.pm.profiles.config \"$Activity_H248MGC1 agent.p-
m.profiles.packages.appendItem$Activity_H248MGC1 agent.pm.profiles.packages
(2).properties.appendItem \MGW Packageset Activity_H248MGW1 [$Traffic2_Network2
activityList.appendItem \-protocolAndType "H248MGW Peer"
]$Activity_H248MGW1 agent.config \"$Activity_H248MGW1 agent.pm.profiles.config
\"$Activity_H248MGW1 agent.pm.profiles.packages.appendItem$Activity_H248MGW1 agent.p-
m.profiles.packages(2).properties.appendItem \
```

#### DESCRIPTION

Configures a collection of properties.

#### SUBCOMMANDS

None.

#### OPTIONS

The options for this command are configured and read using the standard `config`, `cget`, and `getOption` subcommands defined in the `ixConfig` command.

`id`

Indicates the identification for properties. Default="CID"

`hexid`

Indicates the hexadecimal id. Default=1

#### EXAMPLE

```
$Activity_H248MGC1 agent.pm.profiles.packages(2).properties.appendItem \-id
"CID" \-hexid 1
```

#### SEE ALSO

[Packages](#)

## Signals

### VoIP H248 MGC/MGW Signals

#### SYNOPSIS

```
MGC Packagesset Activity_H248MGC1 [$Traffic2_Network2 activityList.appendItem \-
protocolAndType                "H248MGC Peer" ]$Activity_H248MGC1 agent.-
config \ $Activity_H248MGC1 agent.pm.profiles.config \ $Activity_H248MGC1 agent.p-
m.profiles.packages.appendItem$Activity_H248MGC1 agent.pm.profiles.packages
(5).signals.appendItem \MGW Packagesset Activity_H248MGW1 [$Traffic2_Network2 activ-
ityList.appendItem \-protocolAndType                "H248MGW Peer" ]$Activ-
ity_H248MGW1 agent.config \ $Activity_H248MGW1 agent.pm.profiles.config \ $Activity_
H248MGW1 agent.pm.profiles.packages.appendItem$Activity_H248MGC1 agent.p-
m.profiles.packages(5).signals.appendItem \
```

#### DESCRIPTION

Configures a collection of signals.

#### SUBCOMMANDS

None.

#### OPTIONS

The options for this command are configured and read using the standard `config`, `cget`, and `getOption` subcommands defined in the `ixConfig` command.

`id`

Indicates the identification for signals. Default="CID"

`hexid`

Indicates the hexadecimal id. Default=1

#### EXAMPLE

```
$Activity_H248MGC1 agent.pm.profiles.packages(5).signals.appendItem \-id
"CID" \-hexid                1
```

#### SEE ALSO

[Packages](#)

## Statistics

### VoIP H248 MGC/MGW Statistics

#### SYNOPSIS

```
MGC Packageset Activity_H248MGC1 [$Traffic2_Network2 activityList.appendItem \-
protocolAndType "H248MGC Peer" ]$Activity_H248MGC1 agent.-
config \ $Activity_H248MGC1 agent.pm.profiles.config \ $Activity_H248MGC1 agent.p-
m.profiles.packages.appendItem$Activity_H248MGC1 agent.pm.profiles.packages
(16).statistics.appendItem \MGW Packageset Activity_H248MGW1 [$Traffic2_Network2
activityList.appendItem \-protocolAndType "H248MGW Peer"
]$Activity_H248MGW1 agent.config \ $Activity_H248MGW1 agent.pm.profiles.config
\ $Activity_H248MGW1 agent.pm.profiles.packages.appendItem$Activity_H248MGW1 agent.p-
m.profiles.packages(16).statistics.appendItem \
```

#### DESCRIPTION

Configures a collection of statistics.

#### SUBCOMMANDS

None.

#### OPTIONS

The options for this command are configured and read using the standard `config`, `cget`, and `getOption` subcommands defined in the `ixConfig` command.

`id`

Indicates the identification for statistics. Default="CID"

`hexid`

Indicates the hexadecimal id. Default=1

#### EXAMPLE

```
$Activity_H248MGC1 agent.pm.profiles.packages(16).statistics.appendItem \-id
"CID" \-hexid 5
```

#### SEE ALSO

[Packages](#)

## H248 Settings

VoIP H248 Settings for MGW or MGC

### SYNOPSIS

```
H248 Settings for MGWset Activity_H248MGW1 [$Traffic2_Network2 activ-
ityList.appendItem \-protocolAndType "H248MGW Peer" ]$Activ-
ity_H248MGW1 agent.config$Activity_H248MGW1 agent.pm.h248Settings.config
```

```
H248 Settings for MGCset Activity_H248MGC1 [$Traffic2_Network2 activ-
ityList.appendItem \-protocolAndType "H248MGC Peer" ]$Activ-
ity_H248MGC1 agent.config$Activity_H248MGC1 agent.pm.h248Settings.config \
```

### DESCRIPTION

H248 Settings specifies the H248 protocol settings for MGC and MGW.

### SUBCOMMANDS

None.

### OPTIONS

The options for this command are configured and read using the standard `config`, `cget`, and `getOption` subcommands defined in the `ixConfig` command.

`enableTos`

Enables the type of service for H248.

`transportType`

Indicates the transport type of type UDP.

`ipPreference`

Indicates the IP preference of IPv4 or IPv6.

`tos`

Indicates whether the TOS/DSCP byte setting is taken into consideration when sending SIP packets.

`textEncoding`

Indicates the type of text encoding:

- Compact
- Normal
- Pretty

`nUdpMaxSize`

Indicates the maximum size of UDP. Default=1024

protocolVersion

Indicates the versions of the protocol type. Allowed values of protocol versions are 1, 2, or 3.

encodingType

Indicates the encoding type of type text.

### EXAMPLE

```
$Activity_H248MGW1 agent.pm.h248Settings.config \-enableTos
false \-transportType                0 \-ipPreference
0 \-tos                               0 \-textEncoding
3 \-nUdpMaxSize                       1024 \-protocolVersion
3 \-encodingType                       0
```

```
$Activity_H248MGC1 agent.pm.h248Settings.config \-enableTos
false \-transportType                0 \-ipPreference
0 \-tos                               0 \-textEncoding
3 \-nUdpMaxSize                       1024 \-protocolVersion
3 \-encodingType                       0
```

### SEE ALSO

[VoIP H248 Peer Agent](#)

## Codec Settings

VoIP H248 MGC/MGW Term Group Codec settings

### SYNOPSIS

```
VoIP H248 MGC TermGroup Codec Settingsset Activity_H248MGC1 [$Traffic2_Network2
activityList.appendItem \-protocolAndType "H248MGC Peer"
]$Activity_H248MGC1 agent.config \ $Activity_H248TermGroupMGC1 agent.p-
m.codecSettings.config \VoIP H248 MGW TermGroup Codec Settingsset Activity_H248MGW1
[$Traffic2_Network2 activityList.appendItem \-protocolAndType
"H248MGW Peer" ]$Activity_H248MGW1 agent.config \ $Activity_H248TermGroupMGW1 agent.p-
m.codecSettings.config \
```

### DESCRIPTION

Codec Settings contains the list of codecs that is used by the VoIP H248 MGC/MGW Term Groups in the test. Codec Settings is a list of one or more `codec` (audio codec) objects. To add `codec` objects, use the `appendItem` command. To clear the codec settings, use the `clear` subcommand.

### SUBCOMMANDS

None

### OPTIONS

`codecs_number`

Indicates the codec numbers. Default=2

### EXAMPLE

```
$Activity_H248TermGroupMGC1 agent.pm.codecSettings.config \-codecs_number
2
```

### SEE ALSO

[VoIP H248 Peer Agent](#)

## Data Codecs

VoIP H248 MGC/MGW Term Group Data Codecs

### SYNOPSIS

```
VoIP H248 MGC TermGroup Data Codec Settingsset Activity_H248MGC1 [$Traffic2_Network2
activityList.appendItem \-protocolAndType "H248MGC Peer"
]$Activity_H248MGC1 agent.config \ $Activity_H248TermGroupMGC1 agent.p-
m.codecSettings.config \ $Activity_H248TermGroupMGC1 agent.p-
m.codecSettings.dataCodecs.appendItem \VoIP H248 MGW TermGroup Data Codec
Settingsset Activity_H248MGW1 [$Traffic2_Network2 activityList.appendItem \-
protocolAndType "H248MGW Peer" ]$Activity_H248MGW1 agent.-
config \ $Activity_H248TermGroupMGW1 agent.pm.codecSettings.config \ $Activity_H248Ter-
mGroupMGW1 agent.pm.codecSettings.dataCodecs.appendItem \
```

### DESCRIPTION

Data Codecs configures a data codec object, which is added to the `Codec Settings` list of codecs.

### SUBCOMMANDS

None.

### OPTIONS

`id`

Codec type. One of the following:

Codec	Description
Rtp2833Events	Named Events Payload format used for carrying DTMF digits and other line and trunk signals as events.
Rtp2833Tones	RTP Payload format that can represent tones consisting of one or more frequencies.

`dPayloadType`

Payload type used for RTP data packets. Default=(see table) min="96" max="127"

Codec	Default value for dPayloadType
Rtp2833Events	100
Rtp2833Tones	101

### EXAMPLE

```
$Activity_H248TermGroupMGC1 agent.pm.codecSettings.dataCodecs.clear
```

```
$Activity_H248TermGroupMGC1 agent.pm.codecSettings.dataCodecs.appendItem \-id  
"Rtp2833Events" \-dPayloadType 100
```

```
$Activity_H248TermGroupMGC1 agent.pm.codecSettings.dataCodecs.appendItem \-id  
"Rtp2833Tones" \-dPayloadType 101
```

**SEE ALSO**

[Codec Settings](#)



## Codecs

### VoIP H248 MGC/MGW Term Group Audio Codecs

#### SYNOPSIS

```
VoIP H248 MGC TermGroup Codecsset Activity_H248MGC1 [$Traffic2_Network2 activ-
ityList.appendItem \-protocolAndType "H248MGC Peer" ]$Activ-
ity_H248MGC1 agent.config \ $Activity_H248TermGroupMGC1 agent.pm.codecSettings.config
\ $Activity_H248TermGroupMGC1 agent.pm.codecSettings.codecs.appendItem \VoIP H248 MGW
TermGroup Data Codecsset Activity_H248MGW1 [$Traffic2_Network2 activ-
ityList.appendItem \-protocolAndType "H248MGW Peer" ]$Activ-
ity_H248MGW1 agent.config \ $Activity_H248TermGroupMGW1 agent.pm.codecSettings.config
\ $Activity_H248TermGroupMGW1 agent.pm.codecSettings.codecs.appendItem \
```

#### DESCRIPTION

Codecs configures an audio codec object, which is added to the `Codec Settings` list of codecs. To add a codec object, use the `appendItem` command.

#### SUBCOMMANDS

None.

#### OPTIONS

`id`

The codec type, which is one of the following:

Codec	Description
CodecAMR	Adaptive multi-rate codec
CodecG711u	G.711 mu-law codec
CodecG711a	G.711 A-law codec
CodecG723x153	G.723.1 codec @ 5.3 kbps
CodecG723x163	G.723.1 codec @ 6.3 kbps
CodecG726x16	G.726 codec @ 16 Kbps
CodecG726x24	G.726 codec @ 24 Kbps
CodecG726x32	G.726 codec @ 32 Kbps
CodecG726x40	G.726 codec @ 40 Kbps

CodecG729A	G.729 Annex-A codec
CodecILBC	iLBC codec

## Options for CodecAMR

dPayloadIn

Incoming dynamic payload type. Default="98" min="0" max="127".

dPayloadOut

Outgoing dynamic payload type. Default="98" min="0" max="127".

frameSize

Bytes per frame. Must be one of the following: 14. Default=14.

payloadFormat

Payload format.

Value	Usage
0 (default)	Bandwidth-efficient format
1	Octet-aligned format

mode

Codec bit rate. One of the following:

Mode	Description
0 (default)	4.75 kbps
1	5.15 kbps
2	5.90 kbps
3	6.70 kbps
4	7.40 kbps
5	7.95 kbps
6	10.20 kbps

7	12.20 kbps
---	------------

### Options for CodecG711u

dPayloadIn

Incoming dynamic payload type. Default="0" min="0" max="127".

dPayloadOut

Outgoing dynamic payload type. Default="0" min="0" max="127".

frameSize

Bytes per frame. Must be one of the following: 40, 80, 160, 240. Default=160.

### Options for CodecG711a

dPayloadIn

Incoming dynamic payload type. Default="8" min="0" max="127".

dPayloadOut

Outgoing dynamic payload type. Default="8" min="0" max="127".

frameSize

Bytes per frame. Must be one of the following: 40, 80, 160, 240. Default=160.

### Options for CodecG723x153

dPayloadIn

Incoming dynamic payload type. Default="4" min="0" max="127".

dPayloadOut

Outgoing dynamic payload type. Default="4" min="0" max="127".

frameSize

Bytes per frame. Must be one of the following: 20. Default=20.

### Options for CodecG723x163

dPayloadIn

Incoming dynamic payload type. Default="4" min="0" max="127".

dPayloadOut

Outgoing dynamic payload type. Default="4" min="0" max="127".

frameSize

Bytes per frame. Must be one of the following: 24. Default=24.

### Options for CodecG723x163

dPayloadIn

Incoming dynamic payload type. Default="4" min="0" max="127".

dPayloadOut

Outgoing dynamic payload type. Default="4" min="0" max="127".

frameSize

Bytes per frame. Must be one of the following: 24. Default=24.

### Options for CodecG726x16

dPayloadIn

Incoming dynamic payload type. Default="102" min="0" max="127".

dPayloadOut

Outgoing dynamic payload type. Default="102" min="0" max="127".

byteOrder

Byte order.

Option	Description
0 (default)	Big Endian
1	Little Endian

frameSize

Bytes per frame. Must be one of the following: 20, 40, 60. Default=20.

### Options for CodecG726x24

dPayloadIn

Incoming dynamic payload type. Default="103" min="0" max="127".

dPayloadOut

Outgoing dynamic payload type. Default="103" min="0" max="127".

byteOrder

Byte order.

Option	Description
0 (default)	Big Endian
1	Little Endian

frameSize

Bytes per frame. Must be one of the following: 30, 60, 90. Default=30.

### Options for CodecG726x32

dPayloadIn

Incoming dynamic payload type. Default="104" min="0" max="127".

dPayloadOut

Outgoing dynamic payload type. Default="104" min="0" max="127".

byteOrder

Byte order.

Option	Description
0 (default)	Big Endian
1	Little Endian

frameSize

Bytes per frame. Must be one of the following: 40, 80, 120. Default=40.

### Options for CodecG729

dPayloadIn

Incoming dynamic payload type. Default="18" min="0" max="127".

dPayloadOut

Outgoing dynamic payload type. Default="18" min="0" max="127".

cbxFrameSize

Bytes per frame. Must be one of the following: 10, 20, 30, 40, 50, Custom. Default=10.

customFrameSize

If `cbxFrameSize` is Custom, this option configures the custom frame size. Default="120" min="10" max="200".

### EXAMPLE

```
$Activity_H248TermGroupMGC1 agent.pm.codecSettings.codecs.clear
```

```
$Activity_H248TermGroupMGC1 agent.pm.codecSettings.codecs.appendItem \-id  
"CodecG711u" \-dPayloadOut 0 \-dPayloadIn  
0 \-frameSize 160
```

```
$Activity_H248TermGroupMGC1 agent.pm.codecSettings.codecs.appendItem \-id  
"CodecG711a" \-dPayloadOut 8 \-dPayloadIn  
8 \-frameSize 160
```

### SEE ALSO

[Codec Settings](#)

## Other Settings

### VoIPH248 MGC/MGW Term Group Peer Other Settings

#### SYNOPSIS

```
VoIP H248 MGC TermGroup Other Settingsset Activity_H248MGC1 [$Traffic2_Network2
activityList.appendItem \-protocolAndType "H248MGC Peer"
]$Activity_H248MGC1 agent.config \ $Activity_H248TermGroupMGC1 agent.p-
m.otherSettings.configVoIP H248 MGW TermGroup Other Settingsset Activity_H248MGW1
[$Traffic2_Network2 activityList.appendItem \-protocolAndType
"H248MGW Peer" ]$Activity_H248MGW1 agent.config \ $Activity_H248TermGroupMGW1 agent.p-
m.otherSettings.config
```

#### DESCRIPTION

This object configures the VoIP H248 MGC/MGW Term Group Peer activity's miscellaneous options.

#### SUBCOMMANDS

None.

#### OPTIONS

VOIP\_Var0

The VOIP\_Var1...VOIP\_Var5 and VOIP\_IPAddr1...VOIP\_IPAddr5 string-type variables supporting generator expressions enable you to generate 10 series of global variables whose values are used at runtime by the simulated H.248 Term Group phones/channels. `Default=""`.

Use the VOIP\_Var1...VOIP\_Var5 variables to represent phone numbers, and the VOIP\_IPAddr1...VOIP\_IPAddr5 to represent IP addresses.

VOIP\_Var1

See VOIP\_Var0.

VOIP\_Var2

See VOIP\_Var0.

VOIP\_Var3

See VOIP\_Var0.

VOIP\_Var4

See VOIP\_Var0.

VOIP\_IPAddress0

See VOIP\_Var0.

VOIP\_IPAddress1

See VOIP\_Var0.

VOIP\_IPAddress2

See VOIP\_Var0.

VOIP\_IPAddress3

See VOIP\_Var0.

VOIP\_IPAddress4

See VOIP\_Var0.

ipPreference

Type of addressing to be used on the subnet that the VOIP H248 Term Group runs on.

Value	Usage
0 (default)	IPv4
1	IPv6

**EXAMPLE**

```
$Activity_H248TermGroupMGC1 agent.pm.otherSettings.config \-VOIP_Var1  
"" \-VOIP_Var0                               "" \-VOIP_Var3  
"" \-VOIP_Var2                               "" \-VOIP_Var4  
"" \-VOIP_IPAddress4                        "" \-VOIP_IPAddress1  
"" \-VOIP_IPAddress0                       "" \-VOIP_IPAddress3  
"" \-VOIP_IPAddress2                       ""
```

**SEE ALSO**

[VoIP H248 Peer Agent](#)



## SDP Settings

### VoIPH248 MGC/MGW Term Group SDP Settings

#### SYNOPSIS

```
VoIP H248 MGC TermGroup SDP Settingsset Activity_H248MGC1 [$Traffic2_Network2 activ-
ityList.appendItem \-protocolAndType "H248MGC Peer" ]$Activ-
ity_H248MGC1 agent.config \ $Activity_H248TermGroupMGC1 agent.pm.sdpSettings.config
\VoIP H248 MGW TermGroup SDP Settingsset Activity_H248MGW1 [$Traffic2_Network2 activ-
ityList.appendItem \-protocolAndType "H248MGW Peer" ]$Activ-
ity_H248MGW1 agent.config \ $Activity_H248TermGroupMGW1 agent.pm.sdpSettings.config \
```

#### DESCRIPTION

H.248 uses SDP for specification and negotiation of media capabilities of GW terminations. SDP information is sent using a Stream descriptor that specifies as a single bi-directional media stream.

#### SUBCOMMANDS

None.

#### OPTIONS

replaceAutoSdpTemplate

If `true`, the auto SDP template constructed from the codec list can be overridden by editing the SDP template. Default=false

encodeRtpMap

If `true`, a static payload type is included in the auto SDP. Default=false

replaceAutoSDP

If `true`, the auto SDP description constructed from the codecs list is overridden by editing the SDP template. Default=false

skipSdpProcessing

If `true`, the MGC automatically processes and sends Local descriptors (the SDP template). Default=0

autoSdpTemplate

The SDP string that is used when the Auto option is selected for an SDP descriptor. Default="v=0

#### EXAMPLE

```
$Activity_H248TermGroupMGC1 agent.pm.sdpSettings.config \-replaceAutoSdpTemplate
false \-encodeRtpMap false \-replaceAutoSDP
false \-skipSdpProcessing 0 \
-autoSdpTemplate"v=0 c=IN IP4 \ $
```

```
m=audio \${ RTP/AVP 0" \  
-autoSDP"v=0 o=- 0 0 IN IP4 \  
[\${VOIP_MediaIP}] s=session c=IN IP4 \[\${VOIP_MediaIP}] b=CT:1000 t=0 0 m=audio \  
[\${VOIP_MediaBasePort}] RTP/AVP 0 101 a=rtpmap:0 PCMU/8000\a=rtpmap:101 telephone-  
event/8000\a=fmtp:101 0-16"
```

### **SEE ALSO**

[VoIP H248 Peer Agent](#)

## RTP Settings

VoIPH248 MGC/MGW TermGroup RTP settings

### SYNOPSIS

```
VoIP H248 MGC TermGroup RTP Settings$Activity_H248TermGroupMGC1 agent.p-
m.rtpSettings.configVoIP H248 MGW TermGroup RTP Settings$Activity_H248TermGroupMGW1
agent.pm.rtpSettings.config
```

### DESCRIPTION

The RTP Settings configure the VoIPH248 MGC/MGW TermGroup RTP transport settings.

### SUBCOMMANDS

None.

### OPTIONS

enableRTP

If true, enables use of RTP to transport the media traffic. Default= False

rtpPort

The port used for RTP streaming. Default="10000".

enableRTCP

Enables the sending and receiving of RTCP packets.

chEnableHwAcc

If true, enables hardware acceleration for RTP traffic. Default=false.

enableAdvStatCalc

If true, enables the computation of advanced RTP statistics.

enablePerStream

Enables computation of per-stream statistics.

enableMDI

Enables computation of MDI DF and MDI MLR statistics.

enableNBExec

If true, all RTP functions from a scenario execute in a non-blocking mode, i.e the current function from a channel executes in the background, allowing the execution to continue on that channel with the next script function. Default= False.

### EXAMPLE

```
$Activity_H248TermGroupMGC1 agent.pm.rtpSettings.config \-enableRTP
```

```
true \-enableRTCP
false \-chEnableHwAcc
false \-enableAdvStatCalc
false \-rtpPort
false
```

```
false \-enableMDI
true \-chDisableHwAcc
false \-enablePerStream
"\[10000-65535,4\]" \-enableNBExec
```

### **SEE ALSO**

[VoIP H248 Peer Agent](#)

## Audio Settings

H.248 TermGroup audio settings

### SYNOPSIS

```
$Activity_H248TermGroupMGC1 agent.pm.rtpSettings.config\$Activity_H248TermGroupMGW1
agent.pm.rtpSettings.config
```

### DESCRIPTION

The Audio Settings configure the VoIPH248 TermGroup audio RTP settings.

### SUBCOMMANDS

None.

### OPTIONS

`enableAudio`

If selected, audio script functions are executed, otherwise they are skipped.

`audioClip`

The played audio clip file.

`playTypeAudio`

The mode in which the clip is played.

Value	Usage
0 (default)	The clip is played for clip duration or for the duration of the Talk Time parameter in the case of BHCA/CPS/LPS objectives.
1	The clip is played for a user-defined duration.

`audioDurationUnit`

The play duration unit, which can be milliseconds (0), seconds (1), minutes (2), or hours (3).

`outputLevel`

The output level of the played clip.

`enableTosRtp`

Enables use of TOS/DSCP. Use the `rtpTos` option to specify the TOS/DSCP value. Default= False

`rtpTosVal`

The Type of Service (TOS/DSCP) byte setting in the sent RTP packets has one of the following values:

- Best Effort (0x00): Routine service
- Class 1 (0x20): Priority service, Assured Forwarding class 1
- Class 2 (0x40): Immediate service, Assured Forwarding class 2
- Class 3 (0x60): Flash, Assured Forwarding class 3
- Class 4 (0x80): Flash-override, Assured Forwarding class 4
- Express Forwarding (0xA0): Critical-ecp
- Control (0xC0): Internet-control
- Custom: A user-specified value.

useMOS

Enables the computation of MOS scores. Default= False.

enableAudioOWD

If true, IxLoad computes the One-way Delay metric, a network measurement specifying the amount of time (in ms) that a packet has spent on the network before it was received on the destination side.

Default= False

useJitter

If true, enables use of a jitter buffer. Default= False.

jitMs

If **useJitter** is 1, this option configures the size of the jitter buffer, in milliseconds. Default="20" min="1" max="3000".

useJitComp

If true, enables dynamic modification of the jitter buffer size. Default= False.

jitCMs

If **useJitComp** is 1, this option configures the maximum size in of the jitter buffer, in milliseconds. Default="1000" min="0" max="3000".

jitCMaxDrop

If **useJitComp** is 1, this option configures the condition - a maximum number of consecutive packets dropped - that determines the jitter buffer size to be increased.

enableQoV

If true, this enables QoV P.862 PESQ and P.56 QoV computation. Default= False.

channelTypeQoV

When **enableQoV** is true, this specifies the objective type as either of the following:

- Number of channels (0)
- Percentage (1)

valueQoV

When `enableQoV` is `true`, this specifies the number of channels for which PESQ and P.56 QoV metrics are computed (when `channelTypeQoV` is 0). Alternatively this represents the percentage of channels for which PESQ and P.56 QoV metrics are computed (when `channelTypeQoV` is 1).

unitsQoV

The channels selection mode, which can be any of the following:

- First channels (0)
- Last channels (1)
- Evenly-spaced channels (2)
- Random (3)

metricsQoV

When `enableQoV` is `true`, this specifies the metric that is calculated by the Zion card. Available options are:

- PESQ and P.56 (0)
- PESQ (1)
- P56 (2)

useSilence

If `true`, RTP packets containing artificial background noise are sent when no other media (DTMF, MF, real payload, and so on) is sent over the communication channel. Default= `False`.

silenceMode

If `useSilence` is 1, this option configures the silence mode.

Value	Usage
0	Null data encoded
1 (default)	Comfort noise.

## EXAMPLE

```
$Activity_H248TermGroupMGC1 agent.pm.audioSettings.config \-enableAudio
true \-audioClip                                "US_042.wav" \-playTypeAudio
0 \-audioDurationUnit                          1 \-audioDuration
10 \-outputLevel                                -20 \-enableAudioOWD
false \-enableTosRtp                            false \-rtpTosVal
32 \-useMos                                     false \-useJitter
false \-jitMs                                   20 \-useJitComp
false \-jitCMs                                 1000 \-jitCMaxDrop
7 \-enableQoV                                  false \-channelTypeQoV
```

```
0 \-valueQoV          100 \-unitsQoV
0 \-metricsQoV       0 \-useSilence
false \-silenceMode   1 \
```

**SEE ALSO**



## Execution Settings

### VoIP H248 MGC/MGW Term Group Execution Settings

#### SYNOPSIS

```
VoIP H248 MGC TermGroup Execution Settingsset Activity_H248MGC1 [$Traffic2_Network2
activityList.appendItem \-protocolAndType "H248MGC Peer"
]$Activity_H248MGC1 agent.config \ $Activity_H248TermGroupMGC1 agent.p-
m.executionSettings.config \VoIP H248 MGW TermGroup Execution Settingsset Activity_
H248MGW1 [$Traffic2_Network2 activityList.appendItem \-protocolAndType
"H248MGW Peer" ]$Activity_H248MGW1 agent.config \ $Activity_H248TermGroupMGW1 agent.p-
m.executionSettings.config \
```

#### DESCRIPTION

This object defines the execution settings for the VoIP H248 MGC/MGW Term Group.

#### SUBCOMMANDS

None.

#### OPTIONS

The options for this command are configured and read using the standard `config`, `cget`, and `getOption` subcommands defined in the `ixConfig` command.

`gracefulRampDown`

If enabled, allows the user to exit gracefully after a session. Default=1

`loopCount`

If `loopMode` is 1, this option defines the number of loops that the test performs. Default="1".

`loopPreDelay`

Delay before first loop (ms). Default="0".

`loopMode`

Defines how many loops are executed for every voice channel corresponding to this activity.

Value	Description
0 (default)	Loop for the entire test duration.
1	Execute a number of loops. Specify the number of loops in <code>loopCount</code> .

`loopMidDelay`

Delay between loops (ms). Default="0".

**EXAMPLE**

```
$Activity_H248TermGroupMGC1 agent.pm.executionSettings.config \-gracefulRampDown
1 \-loopMidDelay                0 \-loopPreDelay
0 \-loopCount                    2 \-loopMode
1
```

**SEE ALSO**

[VoIP H248 Peer Agent](#)

## Scenario Settings

VoIP H248 MGC/MGW TermGroup Scenario Settings

### SYNOPSIS

```
VoIP H248 MGC TermGroup Scenario Settingsset Activity_H248MGC1 [$Traffic2_Network2
activityList.appendItem \-protocolAndType "H248MGC Peer"
]$Activity_H248MGC1 agent.config \ $Activity_H248TermGroupMGC1 agent.p-
m.scenarioSettings.config \VoIP H248 MGW TermGroup Scenario Settingsset Activity_
H248MGW1 [$Traffic2_Network2 activityList.appendItem \-protocolAndType
"H248MGW Peer" ]\ $Activity_H248MGW1 agent.config \ $Activity_H248TermGroupMGW1
agent.pm.scenarioSettings.config \
```

### DESCRIPTION

Scenario Settings specifies the test scenario file that will be used by the Tcl script.

### SUBCOMMANDS

None.

### OPTIONS

The options for this command are configured and read using the standard `config`, `cget`, and `getOption` subcommands defined in the `ixConfig` command.

`scenarioFile`

The full path to the test scenario file for the activity.

`activeScenarioChannel`

Test scenario channel (0-based index) that is associated with the VoIP H248 Peer activity. Default=0

### EXAMPLE

```
$Activity_H248TermGroupMGC1 agent.pm.scenarioSettings.config \
-scenarioFile "C:\\Documents and Settings\\bmoraru\\My \ Documents
\\Load3.70\\test1.tst" \
-activeScenarioChannel0
```

### SEE ALSO

[VoIP H248 Peer Agent](#)

! 37

## VoIP H.323 Peer

The IxLoad VoIP H.323 Peer Tcl API consists of a VoIP H.323 Peer agent, with separate APIs for configuring each major aspect of the agent's functionality.

## API Overview

### Limitations

The following restrictions and limitations of the VoIPH.323 Peer API exist:

- Individual VoIP H323 script functions can not be added and edited from the Tcl API. Instead, you must add and configure the commands in the Scenario Editor, save the test scenario file, then pass it as an argument to the `ScenarioSettings` API class.
- Implementation of the BHCA objective features relies on two classes, `CustomParameters` and `CustomActivityLinkSettings` that have to be configured using the same parameters.

## VoIP H323 Peer API Commands

The IxLoad VoIP H323 Peer API commands are organized as shown in the following figure.

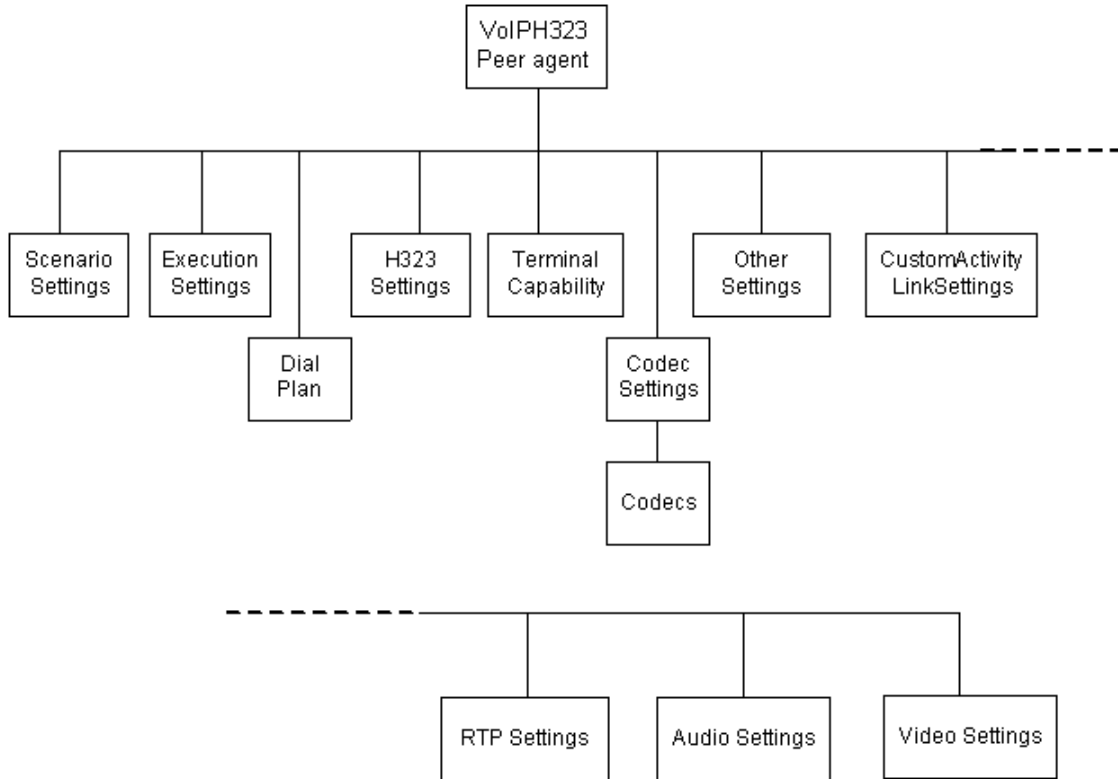

## VoIP H323 Peer API Objects

The following table summarizes the VoIP H323 Peer API Objects

Object	Description
VoIP H323 Peer Agent	Top-level object defining the VoIP H323 Peer activity.
Scenario Settings	Selects the Test Scenario file; corresponds to the Scenario Settings GUI tab.
Codec Settings	List of <code>Codecs</code> objects.
Codecs	Audio codec with parameters.
H323 Settings	VoIP H323 Peer parameters; corresponds to the H323 Settings GUI tab.
Execution Settings	Run-time test configuration; corresponds to the Execution Settings GUI tab.
Terminal Capability	Configures the terminal capability settings.
Dial Plan	Configures the registration names, phone numbers, and source, destination, and transfer addresses for the channels/phones; corresponds to the Dial Plan GUI tab.
RTP Settings	RTP transport configuration; corresponds to the RTP Settings GUI tab.
Audio Settings	Audio settings; corresponds to the Audio GUI tab.
Other Settings	VoIP H323 Peer miscellaneous parameters; corresponds to the Other Settings GUI tab.
Custom Activity Link Settings, CustomParameters	BHCA objective configuration; corresponds to the Custom Parameters GUI tab.

## VoIP H323 Peer Agent

VoIP H323 Peer Agent

### SYNOPSIS

```
set Activity_VoIPH323Peer1 \[$Traffic1_Network1 activityList.appendItem \-
protocolAndType                "VoIPH323 Peer" ]
```

### DESCRIPTION

A VoIP H.323 Peer agent is added to the `agentList` option of the `ixConfig` object using the `appendItem` subcommand from the `ixConfigSequenceContainer` command. Other `ixConfigSequenceContainer` subcommands may be used to modify the `agentList`. See the following example:

```
set Activity_VoIPH323Peer1 \[$Traffic1_Network1 activityList.appendItem \-
protocolAndType                "VoIPH323 Peer" ]$Activity_VoIPH323Peer2 con-
fig \-enable                    true \-name
"VoIPH323Peer1" \-enableConstraint      false \-userObjectiveValue
1 \-constraintValue              100 \-userObjectiveType
"channels" \-timeline              $Timeline1 \
```

```
$Activity_VoIPH323Peer1 agent.config \-enable          true
\ -name                "VoIPH323Peer1"
```

Each member of the list, however may be separately addressed and modified using the `ixConfig` subcommands. For example, the first agent uses an index of 0 and its name may be modified by:

```
$Activity_VoIPH323Peer1 agent(0).config -name "VoIPH323Peer new"
```

### SUBCOMMANDS

None.

### OPTIONS

`enable`

Enables the use of this agent. (Default = true).

`name`

The name associated with this object, which must be set at object creation time.

`uniqueID`

The unique ID of this object. (Default = 1)

### STATISTICS

The available H.323 statistics are listed below.



Statistic	Description	Per Channel/Global
<b>VoIPH323 Channels</b>		
Total Channels	The per polling interval total number of channels, a sum of active and non-active channels.	Global
Completed Channels	The per polling interval number of COMPLETED channels. A channel is COMPLETED if all the channel loops were COMPLETED.	Global
Warning Channels	The per polling interval number of WARNING channels. A channel is WARNING if all the channel loops were COMPLETED or WARNING and at least one loop had a WARNING result.	Global
Failed Channels	The per polling interval number of FAILED channels. A channel is FAILED if all the channel loops were COMPLETED or WARNING, and at least one loop was FAILED.	Global
Aborted Channels	The per polling interval number of ABORTED channels. A channel is ABORTED if all the channel loops were COMPLETED, WARNING, FAILED, or ABORTED and at least one loop was ABORTED.	Global
Active Channels	The per polling interval number of active channels. Active channels are the channels executing a scenario channel functions flow.	Global
<b>VoIPH323 Loops</b>		
Completed Channel Loops	The cumulative count of COMPLETED channel loops. A channel loop is COMPLETED if all executed script functions in the corresponding scenario channel produced SKIPPED or COMPLETED results.	Global
Warning Channel Loops	The cumulative count of WARNING channel loops. A channel loop has a WARNING result if all executed script functions in the corresponding scenario channel produced SKIPPED, COMPLETED, or WARNING results and at least one script function had a WARNING result.	Global

Failed Channel Loops	The cumulative count of FAILED channel loops. A channel loop is FAILED if all executed script functions in the corresponding scenario channel produced SKIPPED, COMPLETED, WARNING, or FAILED results and at least one script function had a FAILED result.	Global
Aborted Channel Loops	The cumulative count of ABORTED channel loops. A channel loop is FAILED if all the executed script functions in the corresponding scenario channel produced SKIPPED, COMPLETED, WARNING, FAILED, or ABORTED results and at least one script function had an ABORTED result.	Global
Total Channel Loops	The cumulative count of executed loops.	Global
Interloop Duration (Avg) [ms]	The time gap between loops.	Global
<b>VoIPH323 Calls</b>		
Attempted Calls	The number of initiated calls.	Global
Connected Calls	The number of established calls.	Global
Received Calls	The number of received incoming calls.	Global
Answered Calls	The number of answered incoming calls.	Global
End Calls Initiated	The count of initiated end call procedures, incremented whenever an Initiate EndCall (EndCall with "Wait other party to disconnect" option is disabled) command execution is started.	Global
End Calls Received	The count of received end call procedures, incremented whenever an Await EndCall(EndCall with "Wait other party to disconnect" option is enabled) command execution is started.	Global
End Calls Completed	The count of completed end call procedures.	Global
Active Calls	The number of active calls at one time. For the initiator side a call is active after having sent a SETUP message and until receiving or sending a RELEASE COMPLETE message. For the terminating side, a call is active after having received SETUP message and until sending or receiving RELEASE COMPLETE message.	Global

Busy Calls	Updated when an incoming call is received for an alias/number on which an existing call is in progress.	Global
<b>VoIPH323 Call Rates</b>		
Attempted calls/s, Connected Calls/s, Received Calls/s, Answered Calls/s, Rejected Calls/s, Busy Calls/s	The per polling interval rates for the above <i>VoIPH323 Call</i> statistics.	Global
<b>VoIPH323 Busy Hour Call Measurements</b>		
BHCA	The per polling interval Busy Hour Call Attempts rate that represents the number of calls initiated in one hour.	Global
BHCC	The per polling interval Busy Hour Call Completions rate that represents the number of calls initiated and connected in one hour.	Global
<b>VoIPH323 Call Times</b>		
Call Setup Time (Avg) [ms]	The average duration between the moment a call is initiated and call is connected.	Global
Talk Time (Avg) [ms]	The average talk time (the duration between the moment the call is connected and the moment the call is disconnected by one of the parties).	Global
End Call Time (Avg) [ms]	From the time the EndCall is executed to the time it takes to tear down the call and complete the EndCall execution.	Global
Total Call Duration (Avg) [ms]	The average call duration. When referring to a single call: (Entire) Call Length = Call Setup-Time + Talk Time + Call Teardown Time.	Global
<b>VoIPH323 Registrations</b>		
Attempted Registrations	This statistic is updated when a RRQ is sent. <b>Note:</b> It is not updated when a light-weight RRQ is sent.	Global

Successful Registrations	This statistic is updated when a RFC is received for an RRQ which is not a light weight RRQ.	Global
Failed Registrations	This statistic is updated when a RRJ is received for an RRQ which is not a light weight RRQ.	Global
Attempted DeRegistrations	This statistic is updated when an URQ is sent.	Global
Successful De-Registrations	The cumulative count of successful de-registrations, incremented when the phone receives the reply <i>UnregisterConfirm</i> message from the gatekeeper.	Global
Failed De-Registrations	This statistic is updated when an URJ is received.	Global
<b>VoIPH323 Registration Rates</b>		
Attempted Registrations /sec	The per polling interval rate of attempted registrations.	Global
Successful Registrations /sec	The per polling interval rate of successful registrations.	Global
Attempted DeRegistrations /sec	The per-polling interval rate of attempted de-registrations.	Global
Successful DeRegistrations /sec	The per polling interval rate of successful registrations.	Global
<b>VoIPH323 Registration Times</b>		
Registration Time (Avg) [ms]	The registration time from the time a RRQ is sent to the time a RCF is received. <b>Note:</b> This statistic is not updated for light-weight RRQ transactions.	Global
DeRegistration Time (Avg) [ms]	The de-registration time from the time an URQ is sent to the time an UCF is received.	Global
<b>VoIPH323 Gatekeeper Discovery Requests</b>		
VoIPH323 GK Request GRQ Transmitted	The number of Gatekeeper requests transmitted.	Global
VoIPH323 GK Confirm GCF Received	The number of Gatekeeper confirmations received.	Global

VoIPH323 GK Reject GRJ Received	The number of Gatekeeper Rejects received.	Global
VOIPH323 GRQ Timed Out	The number of sent Gatekeeper requests that timed out.	Global
<b>VoIPH323 Gatekeeper Registration Requests</b>		
VoIPH323 Registration Request RRQ Transmitted	The number of sent Registration Requests messages transmitted.	Global
VoIPH323 Registration Confirm RCF Received	The number of received confirmation messages.	Global
VoIPH323 Registration Reject RRJ Received	The number of received reject messages.	Global
VOIPH323 RRQ Timed Out	The number of sent request messages that timed out.	Global
<b>VoIPH323 Gatekeeper Admission Requests</b>		
VoIPH323 Admission Request ARQ Transmitted	The number of admission request messages transmitted.	Global
VoIPH323 Admission Confirm ACF Received	The number of admission confirmations received.	Global
VoIPH323 Admission Reject ARJ Received	The number of admission rejects received.	Global
VOIPH323 ARQ Timed Out	The number of sent admission request messages that timed out.	Global
<b>VoIPH323 Gatekeeper Disengage Requests</b>		
VoIPH323 Disengage Request DRQ Transmitted	The number of disengage requests transmitted.	Global
VoIPH323 Disengage Confirm DCF Received	The number of disengage confirmation messages received.	Global
VoIPH323 Disengage Reject DRJ Received	The number of disengage reject messages received.	Global
VOIPH323 DRQ Timed Out	The number of sent request messages that timed out.	Global

VoIPH323 Disengage Request DRQ Received	The number of disengage requests received.	Global
VoIPH323 Disengage Confirm DCF Transmitted	The number of disengage confirmations received.	Global
<b>VoIPH323 Gatekeeper Unregistration Requests</b>		
VoIPH323 Unregister Request URQ Transmitted	The number of unregister requests transmitted.	Global
VoIPH323 Unregister Confirm UCF Received	The number of unregister confirmations received.	Global
VoIPH323 Unregister Reject URJ Received	The number of unregister reject messages received.	Global
VOIPH323 URQ Timed Out	The number of unregister messages that timed out.	Global
VoIPH323 URQ Received	The number of unregister request messages received.	
VoIPH323 UCF Transmitted	The number of unregister confirmation messages transmitted.	
<b>VoIPH323 H225 Requests and Responses</b>		
VoIPH323 Setup Transmitted	The number of Setup messages transmitted.	Global
VoIPH323 Setup Received	The number of Setup messages received.	Global
VoIPH323 CallProceeding Transmitted	The number of CallProceeding messages transmitted.	Global
VoIPH323 CallProceeding Received	The number of CallProceeding messages received.	Global
VoIPH323 Alerting Transmitted	The number of Alerting messages transmitted.	Global
VoIPH323 Alerting Received	The number of Alerting messages received.	Global
VoIPH323 Connect Transmitted	The number of Connect messages transmitted.	Global
VoIPH323 Connect Received	The number of Connect messages received.	Global

VoIPH323 releaseComplete Transmitted	The number of releasecomplete messages transmitted.	Global
<b>VoIPH323 H245 Requests and Responses</b>		
VoIPH323 TCS Transmitted	The number of TerminalCapabilitySet messages transmitted.	Global
VoIPH323 TCS Received	The number of TerminalCapabilitySet messages received.	Global
VoIPH323 TCSAck Transmitted	The number of TerminalCapabilitySetAcknowledgement messages transmitted.	Global
VoIPH323 TCSAck Received	The number of TerminalCapabilitySetAcknowledgement messages received.	Global
VoIPH323 masterSlaveDetermination Transmitted	The number of MasterSlaveDetermination messages transmitted.	Global
VoIPH323 masterSlaveDetermination Received	The number of MasterSlaveDetermination messages received.	Global
VoIPH323 masterSlaveDeterminationAck Transmitted	The number of MasterSlaveDetermination Acknowledgement messages transmitted.	Global
VoIPH323 masterSlaveDeterminationAck Received	The number of MasterSlaveDeterminationAcknowledgement messages received.	Global
VoIPH323 openLogicalChannel Transmitted	The number of OpenLogicalChannel messages transmitted.	Global
VoIPH323 openLogicalChannel Received	The number of OpenLogicalChannel messages received.	Global
VoIPH323 openLogicalChannelAck Transmitted	The number of OpenLogicalChannelAcknowledgement messages transmitted.	Global

VoIPH323 openLogicalChannelAck Received	The number of OpenLogicalChannelAcknowledgement messages received.	Global
VoIPH323 closeLogicalChannel Transmitted	The number of CloseLogicalChannel messages transmitted.	Global
VoIPH323 closeLogicalChannel Received	The number of CloseLogicalChannel messages received.	Global
VoIPH323 closeLogicalChannelAck Transmitted	The number of CloseLogicalChannelAcknowledgement messages transmitted.	Global
VoIPH323 closeLogicalChannelAck Received	The number of CloseLogicalChannelAcknowledgement messages received.	Global
<b>VoIPH323 H245 Reject Messages</b>		
VoIPH323 TCSReject Transmitted	The number of TerminalCapabilitySet reject messages transmitted.	Global
VoIPH323 TCSReject Received	The number of TerminalCapabilitySet reject messages received.	Global
VoIPH323 masterSlaveDeterminationReject Transmitted	The number of MasterSlaveDetermination reject messages transmitted.	Global
VoIPH323 masterSlaveDeterminationReject Received	The number of MasterSlaveDetermination reject messages received.	Global
VoIPH323 openLogicalChannelReject Transmitted	The number of OpenLogicalChannel reject messages transmitted.	Global
VoIPH323 openLogicalChannelReject Received	The number of OpenLogicalChannel reject messages received.	Global
<b>VoIPH323 Errors</b>		
Trigger Errors	The total number of trigger errors.	Global



RTP Errors	The total number of RTP related errors, incremented when any RTP script function is failing or exiting on the Warning or Timeout outputs. Possible causes include media sessions that have been closed by the signaling engine, or <b>Generate DTMF/MF/Tone</b> or <b>Detect DTMF/MF/Tone</b> functions that failed. This statistic is also incremented when the signaling engine cannot start a media session, such as when the negotiated codec or the negotiated <i>ptime</i> is unsupported.	Global
Internal Errors	The total number of internal errors.	Global
Timeout Errors	The total number of script functions that have timed out.	Global
Transport Errors	The total number of transport errors reported during I/O operation.	Global
<b>VoIPH323 Specific Errors</b>		
Parser Error	The total number of parser errors encountered during parsing.	Global
Call Flow Errors	The total number of H323 call flow errors.	Global
<b>VoIPH323 Throughput</b>		
VoIPH323 Bytes Transmitted/sec	The total number of bytes transmitted in H.323 call signaling and call control packets (excluding RTP packets).	Global
VoIPH323 Bytes Received/sec	The total number of bytes received in H.323 call signaling and call control packets (excluding RTP packets).	Global
VoIPH323 Bytes Transmitted And Received/sec	The total number of bytes transmitted and received in H.323 call signaling and call control packets (excluding RTP packets).	Global
<b>VoIPH323 Other</b>		

ActiveCallers	The instantaneous value of H323 callers (on the scenario channel that the objective is applied to) that are active at a given time during the test execution. An emulated H323 caller is considered to be active if he has completed the execution of the Start script function and has not yet reached the Stop function.	Global
---------------	--	--------



**Note:** Statistics from the *Other* category are only stored in application-generated CSV files and are not displayed in any of the predefined views, but can be assigned to custom statistics views of the StatViewer module.

### EXAMPLE

```
set Activity_VoIPH323Peer1 [${Traffic1_Network1 activityList.appendItem \-
protocolAndType                "VoIPH323 Peer" ]

set Timeline1 [::IxLoad new ixTimeline]$Timeline1 config \-rampUpValue
1 \-rampUpType                    0 \-offlineTime
0 \-rampDownTime                  20 \-standbyTime
0 \-iterations                    1 \-rampUpInterval
1 \-sustainTime                   20 \-timelineType
0 \-name                          "Timeline1"

${Activity_VoIPH323Peer1 config \-enable                                true \-name
"VoIPH323Peer1" \-enableConstraint                                   false \-userObjectiveValue
1 \-constraintValue                                                100 \-userObjectiveType
"channels" \-timeline                                             $Timeline1

${Activity_VoIPH323Peer1 agent.config \-enable                        true
\ -name                    "VoIPH323Peer1" \
```

### SEE ALSO

[ixConfig](#)

## Codec Settings

### VoIP H323 Peer Codec Settings

#### SYNOPSIS

```
set Activity_VoIPH323Peer1 [${Traffic1_Network1 activityList.appendItem \-
protocolAndType                "VoIPH323 Peer" ]$Activity_VoIPH323Peer1
agent.config \${Activity_VoIPH323Peer1 agent.pm.codecSettings.config \
```

#### DESCRIPTION

Codec Settings contains the list of codecs that will be used by the VoIP H323 Peers in the test. Codec Settings is a list of one or more `codec` (audio codec) objects. To add `codec` objects, use the `appendItem` command. To clear the codec settings, use the `clear` subcommand.

#### SUBCOMMANDS

`clear`

Clears the list of codec settings. For example:

```
Activity_VoIPH323Peer1 agent.pm.codecSettings.codecs.clear
```

#### OPTIONS

`codecs_number`

Indicates the codec numbers. Default= 0

#### EXAMPLE

```
Activity_VoIPH323Peer1 agent.pm.codecSettings.config \-codecs_number
0
```

#### SEE ALSO

[VoIP H323 Peer Agent](#)

## Codecs

### VoIP H323 Peer Audio Codec

#### SYNOPSIS

```
set Activity_VoIPH323Peer1 [$Traffic1_Network1 activityList.appendItem \-
protocolAndType                "VoIPH323 Peer" ]$Activity_VoIPH323Peer1
agent.config \ $Activity_VoIPH323Peer1 agent.pm.codecSettings.config \ $Activity_
VoIPH323Peer1 agent.pm.codecSettings.codecs.appendItem \
```

#### DESCRIPTION

Codecs configures an audio codec object, which is added to the `Codec Settings` list of codecs. To add a codec object, use the `appendItem` command.

#### SUBCOMMANDS

None.

#### OPTIONS

`id`

Codec type. One of the following:

Codec	Description
CodecAMR	Adaptive multi-rate codec
CodecG711u	G.711 mu-law codec
CodecG711a	G.711 A-law codec
CodecG723x153	G.723.1 codec @ 5.3 kbps
CodecG723x163	G.723.1 codec @ 6.3 kbps
CodecG726x16	G.726 codec @ 16 Kbps
CodecG726x24	G.726 codec @ 24 Kbps
CodecG726x32	G.726 codec @ 32 Kbps
CodecG726x40	G.726 codec @ 40 Kbps
CodecG729A	G.729 Annex-A codec
CodecILBC	Internet low-bitrate codec

## Options for CodecAMR

dPayloadIn

Incoming dynamic payload type. Default="98" min="0" max="127".

dPayloadOut

Outgoing dynamic payload type. Default="98" min="0" max="127".

frameSize

Bytes per frame. Must be one of the following: 14. Default=14.

payloadFormat

Payload format.

Value	Usage
0 (default)	Bandwidth-efficient format
1	Octet-aligned format

mode

Codec bit rate. One of the following:

Mode	Description
0 (default)	4.75 kbps
1	5.15 kbps
2	5.90 kbps
3	6.70 kbps
4	7.40 kbps
5	7.95 kbps
6	10.20 kbps
7	12.20 kbps

## Options for CodecG711u

dPayloadIn

Incoming dynamic payload type. Default="0" min="0" max="127".

dPayloadOut

Outgoing dynamic payload type. Default="0" min="0" max="127".

frameSize

Bytes per frame. Must be one of the following: 40, 80, 160, 240. Default=160.

### **Options for CodecG711a**

dPayloadIn

Incoming dynamic payload type. Default="8" min="0" max="127".

dPayloadOut

Outgoing dynamic payload type. Default="8" min="0" max="127".

frameSize

Bytes per frame. Must be one of the following: 40, 80, 160, 240. Default=160.

### **Options for CodecG723x153**

dPayloadIn

Incoming dynamic payload type. Default="4" min="0" max="127".

dPayloadOut

Outgoing dynamic payload type. Default="4" min="0" max="127".

frameSize

Bytes per frame. Must be one of the following: 20. Default=20.

### **Options for CodecG723x163**

dPayloadIn

Incoming dynamic payload type. Default="4" min="0" max="127".

dPayloadOut

Outgoing dynamic payload type. Default="4" min="0" max="127".

frameSize

Bytes per frame. Must be one of the following: 24. Default=24.

### **Options for CodecG723x163**

dPayloadIn

Incoming dynamic payload type. Default="4" min="0" max="127".

dPayloadOut

Outgoing dynamic payload type. Default="4" min="0" max="127".

frameSize

Bytes per frame. Must be one of the following: 24. Default=24.

### Options for CodecG726x16

dPayloadIn

Incoming dynamic payload type. Default="102" min="0" max="127".

dPayloadOut

Outgoing dynamic payload type. Default="102" min="0" max="127".

byteOrder

Byte order.

Option	Description
0 (default)	Big Endian
1	Little Endian

frameSize

Bytes per frame. Must be one of the following: 20, 40, 60. Default=20.

Options for CodecG726x24

dPayloadIn

Incoming dynamic payload type. Default="103" min="0" max="127".

dPayloadOut

Outgoing dynamic payload type. Default="103" min="0" max="127".

byteOrder

Byte order.

Option	Description
0 (default)	Big Endian
1	Little Endian

frameSize

Bytes per frame. Must be one of the following: 30, 60, 90. Default=30.

### Options for CodecG726x32

dPayloadIn

Incoming dynamic payload type. Default="104" min="0" max="127".

dPayloadOut

Outgoing dynamic payload type. Default="104" min="0" max="127".

byteOrder

Byte order.

Option	Description
0 (default)	Big Endian
1	Little Endian

frameSize

Bytes per frame. Must be one of the following: 40, 80, 120. Default=40.

### Options for CodecG729

dPayloadIn

Incoming dynamic payload type. Default="18" min="0" max="127".

dPayloadOut

Outgoing dynamic payload type. Default="18" min="0" max="127".

cbxFrameSize

Bytes per frame. Must be one of the following: 10, 20, 30, 40, 50, Custom. Default=10.

customFrameSize

If `cbxFrameSize` is `Custom`, this option configures the custom frame size. Default="120" min="10" max="200".

### EXAMPLE

```
$Activity_VoIPH323Peer1 agent.pm.codecSettings.codecs.clear
```

```
$Activity_VoIPH323Peer1 agent.pm.codecSettings.codecs.appendItem \-id  
"CodecG711u" \-dPayloadOut 0 \-dPayloadIn  
0 \-frameSize 160
```

```
$Activity_VoIPH323Peer1 agent.pm.codecSettings.codecs.appendItem \-id
```



```
"CodecG711a" \-dPayloadOut      8 \-dPayloadIn
8 \-frameSize                    160
```

**SEE ALSO**

[Codec Settings](#)

## Data Codecs

VoIP H248 MGC/MGW Term Group Data Codecs

### SYNOPSIS

```
set Activity_VoIPH323Peer1 [$Traffic1_Network1 activityList.appendItem \-
protocolAndType                "VoIPH323 Peer" ]$Activity_VoIPH323Peer1
agent.config \ $Activity_VoIPH323Peer1 agent.pm.codecSettings.config \ $Activity_
VoIPH323Peer1 agent.pm.codecSettings.dataCodecs.appendItem \
```

### DESCRIPTION

Data Codecs configures a data codec object, which is added to the `Codec Settings` list of codecs.

### SUBCOMMANDS

None.

### OPTIONS

`id`

Codec type. One of the following:

Codec	Description
Rtp2833Events	Named Events Payload format used for carrying DTMF digits and other line and trunk signals as events.
Rtp2833Tones	RTP Payload format that can represent tones consisting of one or more frequencies.

`dPayloadType`

Payload type used for RTP data packets. Default=(see table) min="96" max="127"

Codec	Default value for dPayloadType
Rtp2833Events	100
Rtp2833Tones	101

### EXAMPLE

```
$Activity_VoIPH323Peer1 agent.pm.codecSettings.dataCodecs.clear
```

```
$Activity_VoIPH323Peer1 agent.pm.codecSettings.dataCodecs.appendItem \-id
"Rtp2833Events" \-dPayloadType                100
```

```
$Activity_VoIPH323Peer1 agent.pm.codecSettings.dataCodecs.appendItem \-id  
"Rtp2833Tones" \-dPayloadType 101
```

```
$Activity_VoIPH323Peer1 agent.pm.codecSettings.codecs.clear
```

**SEE ALSO**

[Codec Settings](#)

## Other Settings

### VoIPH323 Peer Other Settings

#### SYNOPSIS

```
set Activity_VoIPH323Peer1 [$Traffic1_Network1 activityList.appendItem \-  
protocolAndType "VoIPH323 Peer" ]$Activity_VoIPH323Peer1  
agent.config \ $Activity_VoIPH323Peer1 agent.pm.otherSettings.config \
```

#### DESCRIPTION

This object configures the VoIP H323 Peer activity's miscellaneous options.

#### SUBCOMMANDS

None.

#### OPTIONS

VOIP\_Var0

The VOIP\_Var1...VOIP\_Var5 and VOIP\_IPAddr1...VOIP\_IPAddr5 string-type variables supporting generator expressions enable you to generate 10 series of global variables whose values are used at runtime by the simulated H.323 phones/channels. Default="".

Use the VOIP\_Var1...VOIP\_Var5 variables to represent phone numbers, and the VOIP\_IPAddr1...VOIP\_IPAddr5 to represent IP addresses.

VOIP\_Var1

See VOIP\_Var0.

VOIP\_Var2

See VOIP\_Var0.

VOIP\_Var3

See VOIP\_Var0.

VOIP\_Var4

See VOIP\_Var0.

VOIP\_IPAddress0

See VOIP\_Var0.

VOIP\_IPAddress1

See VOIP\_Var0.

VOIP\_IPAddress2

See VOIP\_Var0.

VOIP\_IPAddress3

See VOIP\_Var0.

VOIP\_IPAddress4

See VOIP\_Var0.

ipPreference

Type of addressing to be used on the subnet that the VOIP H323 Peer runs on.

Value	Usage
0 (default)	IPv4
1	IPv6

### EXAMPLE

```
$Activity_VoIPH323Peer1 agent.pm.otherSettings.config \-ipPreference
0 \-stackConfigFilename          "" \-VOIP_Var1
"" \-VOIP_Var0                    "" \-VOIP_Var3
"" \-VOIP_Var2                    "" \-VOIP_Var4
"" \-VOIP_IPAddress4              "" \-totalUserCount
0 \-VOIP_IPAddress1               "" \-VOIP_IPAddress0
"" \-VOIP_IPAddress3              "" \-VOIP_IPAddress2
""
```

### SEE ALSO

[VoIP H323 Peer Agent](#)

## RTP Settings

VoIPH323 Peer RTP Settings

### SYNOPSIS

```
$Activity_VoIPH323Peer1 agent.pm.rtpSettings.config \  
-optionvalue
```

### DESCRIPTION

RTP Settings configures the VoIPH323Peer RTP transport settings.

### SUBCOMMANDS

None.

### OPTIONS

enableRTP

Enables use of RTP to transport the media traffic.

0 = disabled (default)

1 = enabled

rtpPort

RTP port number. Default="10000".

**Note:** Valid port numbers are between 1000 and 65534.

enableRTCP

Enables the sending and receiving of RTCP packets.

chEnableHwAcc

If true, enables hardware acceleration for RTP traffic. Default=false.

enableAdvStatCalc

Enables the computation of advanced RTP statistics.

enablePerStream

Enables computation of per-stream statistics.

enableMDI

Enables computation of MDI DF and MDI MLR statistics.

### EXAMPLE

```
$Activity_VoIPH323Peer1 agent.pm.rtpSettings.config \-enableRTP
```

```
true \-enableRTCP
false \-chEnableHwAcc
false \-enablePerStream
"\[10000-65535,4\]" \
false \-enableMDI
true \-enableAdvStatCalc
false \-rtpPort
```

**SEE ALSO**

## Audio Settings

VoIPH323 Peer audio settings

### SYNOPSIS

```
$Activity_VoIPH323Peer1 agent.pm.audioSettings.config \
```

### DESCRIPTION

The Audio Settings configure the VoIPH323 Peer audio RTP settings.

### SUBCOMMANDS

None.

### OPTIONS

`enableAudio`

If selected, audio script functions are executed, otherwise they are skipped.

`audioClip`

The played audio clip file.

`playTypeAudio`

The mode in which the clip is played.

Value	Usage
0 (default)	The clip is played for clip duration or for the duration of the Talk Time parameter in the case of BHCA/CPS/LPS objectives.
1	The clip is played for a user-defined duration.

`audioDurationUnit`

The play duration unit, which can be milliseconds (0), seconds (1), minutes (2), or hours (3).

`outputLevel`

The output level of the played clip.

`enableTosRtp`

Enables use of TOS/DSCP. Use the `rtpTos` option to specify the TOS/DSCP value. Default= False

`rtpTosVal`

- The Type of Service (TOS/DSCP) byte setting in the sent RTP packets has one of the following values:



- Best Effort (0x00): Routine service
- Class 1 (0x20): Priority service, Assured Forwarding class 1
- Class 2 (0x40): Immediate service, Assured Forwarding class 2
- Class 3 (0x60): Flash, Assured Forwarding class 3
- Class 4 (0x80): Flash-override, Assured Forwarding class 4
- Express Forwarding (0xA0): Critical-ecp
- Control (0xC0): Internet-control
- Custom: A user-specified value.

useMOS

Enables the computation of MOS scores. Default= False.

enableAudioOWD

If true, IxLoad computes the One-way Delay metric, a network measurement specifying the amount of time (in ms) that a packet has spent on the network before it was received on the destination side.

Default= False

useJitter

If true, enables use of a jitter buffer. Default= False.

jitMs

If useJitter is 1, this option configures the size of the jitter buffer, in milliseconds. Default="20" min="1" max="3000".

useJitComp

If true, enables dynamic modification of the jitter buffer size. Default= False.

jitCMs

If useJitComp is 1, this option configures the maximum size in of the jitter buffer, in milliseconds. Default="1000" min="0" max="3000".

jitCMaxDrop

If useJitComp is 1, this option configures the condition - a maximum number of consecutive packets dropped - that determines the jitter buffer size to be increased.

enableQoV

If true, this enables QoV P.862 PESQ and P.56 QoV computation. Default= False.

channelTypeQoV

When enableQoV is true, this specifies the objective type as either of the following:

- Number of channels (0)
- Percentage (1)

valueQoV

When `enableQoV` is `true`, this specifies the number of channels for which PESQ and P.56 QoV metrics are computed (when `channelTypeQoV` is 0). Alternatively this represents the percentage of channels for which PESQ and P.56 QoV metrics are computed (when `channelTypeQoV` is 1).

`unitsQoV`

The channels selection mode, which can be any of the following:

- First channels (0)
- Last channels (1)
- Evenly-spaced channels (2)
- Random (3)

`metricsQoV`

When `enableQoV` is `true`, this specifies the metric that is calculated by the Zion card. Available options are:

- PESQ and P.56 (0)
- PESQ (1)
- P56 (2)

`useSilence`

If `true`, RTP packets containing artificial background noise are sent when no other media (DTMF, MF, real payload, and so on) is sent over the communication channel. `Default= False`.

`silenceMode`

If `useSilence` is 1, this option configures the silence mode.

Value	Usage
0	Null data encoded
1 (default)	Comfort noise.

## EXAMPLE

```
$Activity_VoIPH323Peer1 agent.pm.audioSettings.config \-enableAudio
true \-audioClip "US_042.wav" \-playTypeAudio
0 \-audioDurationUnit 1 \-audioDuration
10 \-outputLevel -20 \-enableAudioOWD
false \-enableTosRtp false \-rtpTosVal
32 \-useMos false \-useJitter
false \-jitMs 20 \-useJitComp
false \-jitCMs 1000 \-jitCMaxDrop
7 \-enableQoV false \-channelTypeQoV
0 \-valueQoV 100 \-unitsQoV
```

```
0 \-metricsQoV  
false \-silenceMode
```

```
0 \-useSilence  
1 \
```

**SEE ALSO**

## Video Settings

VoIPH323 Peer Video Settings

### SYNOPSIS

```
$Activity_VoIPH323Peer1 agent.pm.VideoSettings.config \  
-optionvalue
```

### DESCRIPTION

Video Settings configures the VoIPH323 Peer's video settings.

### SUBCOMMANDS

None.

### OPTIONS

enableVideo

Enables use of video as media traffic.

0 = disabled (default)

1 = enabled

videoClip

Name of the video file. Default = "Fire\_avc.mp4"

playTypeVideo

Determines parameters for running video. Following values are available:

Value	Usage
0 (default)	Play for clip duration
1	Play for specified duration.
2	Conference mode

videoDuration

If `playTypeVideo = 1`, determines duration of video. Maximum value = 259200000.

videoDurationUnit

Unit of duration. The following values are available:

Value	Usage
0	milliseconds
1	seconds
2	minutes
3	hours

`useConference`

If `playTypeVideo = 2`, enables use of conference mode. The following values are available:

Value	Usage
0	All speak
1	Sequential
2	Random

`confVideoDuration`

If `playTypeVideo = 2`, enables selection of conference video duration.

`confVideoDurationUnit`

If `playTypeVideo = 2`, enables selection unit of conference video duration. The following values are available:

Value	Usage
0	milliseconds
1	seconds
2	minutes
3	hours

`confDuration`

If `playTypeVideo = 2`, enables selection of conference audio duration.

`confDurationUnit`

If `playTypeVideo = 2`, enables selection unit of conference audio duration. The following values are available:

Value	Usage
0	milliseconds
1	seconds
2	minutes
3	hours

`enableTosVideo`

Enables use of TOS/DSCP. Use the `tosVideo` option to specify the TOS/DSCP value.

`tosVideo`

The following values are available:

Value	Usage
0	Best Effort (0x00)"
1	Class 1 (0x20)
2	Class 2 (0x40)
3	Class 3 (0x60)
4	Class 4 (0x80)
5	Express Forwarding (0xA0)
6	Control (0xC0)
7	Custom

`useMosVideo`

Enables computation of MOS.

0 = disabled (default)

1 = enabled

**Note:** If MOS computation is enabled, the `enableVideoOWD` option also has to be enabled.

`enableVideoOWD`

If enabled, the One-way Delay metric is computed, a network measurement specifying the amount of time (in ms) that a packet has spent on the network before it was received on the destination side.

Default = disabled.

`ignoreHintTrack`

If enabled, the hint track (if any) in the video clip is ignored. The video streaming uses a new hint track which is recreated using one of the packetization modes defined by `hintTrackType`. Default = disabled.

`hintTrackType`

Allows to select the packetization mode. The following values are available:

Value	Usage
0 (default)	Single NAL Unit
1	STAP-A, with FU-A fragmentation

`AdvancedVideoSettings`

If enabled, allows selecting the advanced settings. Valid only for H323 activities.

`enableCustomMaxMBPS`

If enabled, allows selecting the maximum number of macroblocks per second supported. Default = disabled.

`customMaxMBPS`

The maximum number of macroblocks per second supported.

`enableCustomMaxFS`

If enabled, allows selecting the maximum frame size supported. Default = disabled.

`customMaxFS`

The maximum frame size supported.

`enableCustomMaxDPB`

If enabled, allows selecting the maximum decoded picture buffer size supported. By default it is disabled.

`customMaxDPB`

The maximum decoded picture buffer size supported.

`enableCustomMaxBRandCPB`

If enabled, allows selecting the maximum supported video bitrate and coded picture buffer.

`customMaxBRandCPB`

The maximum number of static macroblocks per second.

`enableMaxStaticMBPS`

If enabled, allows selecting the maximum number of static macroblocks per second. Default = disabled.

maxStaticMBPS

The maximum number of static macroblocks per second.

enableMaxRcmdNalUnitSize

If enabled, allows selecting the maximum recommended NALU size. Default = disabled.

enableMaxNalUnitSize

If enabled, allows selecting the maximum NALU size supported. Default = disabled.

maxNalUnitSize

The maximum NALU size supported.

### EXAMPLE

```
$Activity_VoIPH323Peer1 agent.pm.videoSettings.config \-rotationScheme
0 \-confDuration 1 \-useMosVideo
false \-enableVideoOWD false \-ignoreHintTrack
false \-enableTosVideo true \-enableVideo
true \-videoClip "Fire_avc.mp4" \-
useH323AdvancedSettings false \-videoDuration
5 \-confVideoDurationUnit 1 \-useConference
false \-confDurationUnit 1 \-confVideoDuration
1 \-videoDurationUnit 1 \-hintTrackType
1 \-fmt " \-rtpmap
" \-playTypeVideo 0 \-tosValVideo
32
```

### SEE ALSO



## Alternative Capability Value Set List

VoIP H323 Alternative Capability Value Set List

### SYNOPSIS

```
set Activity_VoIPH323Peer1 [$Traffic1_Network1 activityList.appendItem \-
protocolAndType           "VoIPH323 Peer" ]$Activity_VoIPH323Peer1
agent.config \ $Activity_VoIPH323Peer1 agent.p-
m.alternativeCapabilitySetList.alternativeCapabilityValueSetList.appendItem \
```

### DESCRIPTION

Helps to configure the alternative capability value list.

### SUBCOMMANDS

None.

### OPTIONS

id

Indicates the id of the alternative capability name.

Default= "AlternativeCapability"

alternativeCapabilityName

The name of the alternative capability list.

Default= "Default\_Alternative\_Capability"

refCount

The reference count that is used to deallocate objects which are no longer referenced. Default= 0

### EXAMPLE

```
$Activity_VoIPH323Peer1 agent.p-
m.alternativeCapabilitySetList.alternativeCapabilityValueSetList.appendItem \
-id "AlternativeCapability" \
-alternativeCapabilityName"Default_Alternative_Capability" \
-refCount 0
```

### SEE ALSO

[VoIP H323 Peer Agent](#)

## Capability List

VoIP H323 Alternative Capability Value Set List

### SYNOPSIS

```
set Activity_VoIPH323Peer1 [$Traffic1_Network1 activityList.appendItem \-
protocolAndType                "VoIPH323 Peer" ]$Activity_VoIPH323Peer1
agent.config \($Activity_VoIPH323Peer1 agent.p-
m.alternativeCapabilitySetList.alternativeCapabilityValueSetList.appendItem \($Activ-
ity_VoIPH323Peer1
agent.p-
m.al-
ternativeCapabilitySetList.alternativeCapabilityValueSetList.capabilityList.appendItem
\
```

### DESCRIPTION

Helps to configure the capability list.

### SUBCOMMANDS

None.

### OPTIONS

id

Indicates the id of the capability list. Default= "Capability".

transportType

The transport type used for the VoIP data for the various versions. Default= 3.

capabilityTableEntryNumber

The number that is entered in the capability table. This table is referred to take policy actions based on whether the system has a particular capability. Default= 1

### EXAMPLE

```
$Activity_VoIPH323Peer1 agent.p-
m.al-
ternativeCapabilitySetList.alternativeCapabilityValueSetList.capabilityList.appendItem
\ -id                "Capability" \ -transportType
3 \ -capabilityTableEntryNumber      1
```

### SEE ALSO

[VoIP H323 Peer Agent](#)

## Custom Activity Link Settings

VoIP H323 Peer CustomActivityLinkSettings

### SYNOPSIS

```
set Activity_VoIPH323Peer1 [$Traffic1_Network1 activityList.appendItem \-
protocolAndType                "VoIPH323 Peer" ]$Activity_VoIPH323Peer1
agent.config \ $Activity_VoIPH323Peer1 agent.pm.customActivityLinkSettings.config \
```

### DESCRIPTION

CustomActivityLinkSettings configures the settings for the BHCA objective for VoIPH323 Peer activities. This options in this object correspond to the controls on the Custom Parameters tab for a NetTraffic/ActivityLink in the Timeline and Objective branch of the Test Configuration tree in the IxLoad GUI.

**Note:** The CustomActivityLinkSettings class must be configured alongside the CustomParameters class that implements the same functionality.

**Note:** CPS objective related settings are not available for VoIPH323 Peer activities.

### SUBCOMMANDS

None.

### OPTIONS

bhcaObjectiveValue

The BHCA test objective value. Default="80000".

bhcaType

Determines how the BHCA objective will be met: by specifying the talk time or the number of channels.

Value	Usage
0 (default)	BHCA will be met by specifying the talk time. Specify the talk time in <code>talkTime</code> .
1	BHCA will be met by specifying the number of channels. Specify the number of channels in <code>channelsNo</code> .

talkTime

If `bhcaType` is 0, this option specifies the Talk Time that will be used to attain the BHCA test objective. Default="40000".

channelsNo

If `bhcaType` is 1, this option specifies the number of channels that will be used to attain the BHCA test objective. Default="100".

callSetupTime

Estimated call setup time. Default="500".

callTeardownTime

Estimated call teardown time. Default="500".

interCallDuration

Inter-call duration. Default="4000".

**EXAMPLE**

```
$Activity_VoIPH323Peer1 agent.pm.customActivityLinkSettings.config \-talkTime
40000 \-cpsObjectiveValue          100 \-cpsType
0 \-cpsInterCallDuration          150 \-channelsNo
1 \-cpsTalkTime                    750 \-cpsOverheadTime
100 \-cpsChannelsNo               100 \-bhcaType
0 \-callTeardownTime              500 \-interCallDuration
4000 \-bhcaObjectiveValue         80000 \-callSetupTime
500
```

**SEE ALSO**

[VoIP H323 Peer Agent](#)

## Execution Settings

### VoIP H323 Peer Execution Settings

#### SYNOPSIS

```
set Activity_VoIPH323Peer1 [$Traffic1_Network1 activityList.appendItem \-
protocolAndType                "VoIPH323 Peer" ]$Activity_VoIPH323Peer1
agent.config \ $Activity_VoIPH323Peer1 agent.pm.executionSettings.config \
```

#### DESCRIPTION

This object defines the execution settings for the VoIP H323 Peer.

#### SUBCOMMANDS

None.

#### OPTIONS

The options for this command are configured and read using the standard `config`, `cget`, and `getOption` subcommands defined in the `ixConfig` command.

`gracefulRampDown`

If enabled, the execution is stopped gracefully and the call is closed before the rampdown period ends.

`loopCount`

If `loopMode` is 1, this option defines the number of loops that the test performs.

Default="1".

`loopPreDelay`

Delay before first loop (ms). Default="0".

`loopMode`

Defines how many loops are executed for every voice channel corresponding to this activity.

Value	Description
0 (default)	Loop for the entire test duration.
1	Execute a number of loops. Specify the number of loops in <code>loopCount</code> .

`loopMidDelay`

Delay between loops (ms). Default="0".

`phoneRule`

Defines how phone numbers are incremented for H323 activity.

**EXAMPLE**

```
$Activity_VoIPH323Peer1 agent.pm.executionSettings.config \-gracefulRampDown
true \-loopCount          1 \-loopPreDelay
0 \-loopMode              0 \-loopMidDelay
0 \-phoneRule             1
```

**SEE ALSO**

[VoIP H323 Peer Agent](#)

## Simultaneous Capability

VoIP H323 Simultaneous Capability

### SYNOPSIS

```
set Activity_VoIPH323Peer1 [$Traffic1_Network1 activityList.appendItem \-  
protocolAndType           "VoIPH323 Peer" ]$Activity_VoIPH323Peer1  
agent.config \ $Activity_VoIPH323Peer1 agent.pm.simultaneousCapability.config \
```

### DESCRIPTION

Configures the simultaneous capability name.

### SUBCOMMANDS

None.

### OPTIONS

refCount

The reference count that is used to deallocate objects which are no longer referenced. Default= 0

simultaneousCapabilityName

The name of the simultaneous capability. Default= ""

### EXAMPLE

```
$Activity_VoIPH323Peer1 agent.pm.simultaneousCapability.config \-refCount  
0 \-simultaneousCapabilityName           ""
```

### SEE ALSO

[VoIP H323 Peer Agent](#)

## H323 Settings

### VoIP H323 Peer Signaling Settings

#### SYNOPSIS

```
set Activity_VoIPH323Peer1 [$Traffic1_Network1 activityList.appendItem \-  
protocolAndType "VoIPH323 Peer" ]$Activity_VoIPH323Peer1  
agent.config \ $Activity_VoIPH323Peer1 agent.pm.h323Settings.config \
```

#### DESCRIPTION

This object defines the VoIP H323 Peer settings.

#### SUBCOMMANDS

None.

#### OPTIONS

`enableParallelH245`

If true, H.323 initiates parallel H.245 channel establishment simultaneously with FastStart. Default= False

**Note:** This option is enabled only if `enableFastStart` is true.

`useGKforAdmission`

If true, `MakeCall` sends ARQ request to gatekeeper and waits for ACF request before establishing the call. Default= False

`H225Version`

The version specified in the protocol-identifier field of the Q.931 and RAS packet. Default= 5

`rasRetryCount`

Sets the number of retries to be done for RAS requests. Default= 1

`enableDisengage`

If true, `EndCall` request sends a Disengage message to the gatekeeper. Default= False

`textUserUser`

Specifies the user information to be sent in the Q.931 User-User IE. This can be either a character string or a byte stream encoded in hexadecimal digits. Default= False

`bandwidth`

The value of bandwidth requested by the endpoint and also advertised in RAS messages. Default= 64 Kbps

`textDisplay`



---

Specifies the display information that is sent in the Q.931 Display IE.

enableH245tunneling

If true, H323 uses tunnel H.245 payloads within Q.931/H.225 packets. Default= True

enableCallAlerting

If true, sends out a call alerting message. Default= False

GKAdresstext

If enableAutoGKDiscovery is false, you can specify IP address or hostname for up to three gatekeepers. The plug-in, in this case, accepts redirection requests for the gatekeepers. Default= False

enableTos

If true, allows to configure Type of Service.TOS value is set for all UDP and TCP packets originating from the IxLoad H.323 stack.

useRegistration

Parameters

If true, the values sent by the gatekeeper during registration overrides the corresponding values set by the user for various parameters. Default= False

enableFastStart

If true, H.323 call establishment tries to use the FastStart mechanism. Default= True

ckHexUserUserData

If true, the user information that is sent in the Q.391 UserUser IE can be sent as a byte stream encoded in hexadecimal digits. Default= False

rasTimeout

Sets the number of seconds after which a RAS request reaches time-out state if no response to that request is received in the specified period. After a timeout, retry happens if so configured. Default= 4 seconds

enableCallProceeding

If true, sends out a call proceeding message. Default= False

enableRas

If true, RAS message is sent and received. Default= False

enableKeepAliveReg

If true, sends keep alive ARQ to the gatekeeper. Default= False

GKAddress

If `enableAutoGKdiscovery` is true, the IP address or hostname can be specified up to three gatekeepers.

`tosVal`

If `enableTos` is true, this option sets the value of the TOS bits.

Value	Usage
0 (default)	Best Effort (0x00)
1	Class 1 (0x20)
2	Class 2 (0x40)
3	Class 3 (0x60)
4	Class 4 (0x80)
5	Express Forwarding (0xA0)
6	Control (0xC0)

`displayData`

Specifies the display information to be sent in the Q.931 Display IE. This is IA5 character string. This field supports sequence generators. Default= "Ixia\[00-\\]" \

`terminalType`

Indicates the type of the endpoint. The terminal types are:

- Terminal Entity Without MC
- Gatekeeper Entity Without MC

`H245Version`

Specified version in the protocol-identifier field of the H.245 packet. Default= 9.

`autoRegisterToGk`

If true, H.323 MakeCall option sends RAS signaling (including registration) to establish the call and EndCall unregisters with the gatekeeper. Default= False.

`userUserData`

Specifies the user information to be sent in the Q.931 User-User IE. This can be either IA5 character string or a byte stream encoded in hexadecimal digits. This field supports sequence generators for IA5 characters. Default= "1234\[00-\\]" \.

`enableAutoGKdiscovery`

If true, Automatic Gatekeeper Discovery is attempted by sending GRQ to the well-known Discovery Multicast Address. Default= False.

callSignalingViaUDP

If true, call signaling is done over UDP and not over TCP as per Annex E specification. Default= False.

enableH323

If true, the H323 script functions are executed; otherwise they are skipped. Default= True.

### EXAMPLE

```
$Activity_VoIPH323Peer1 agent.pm.h323Settings.config \-enableParallelH245
false \-useGKforAdmission                false \-H225Version
5 \-rasRetryCount                          1 \-enableDisengage
false \-textUserUser                       false \-bandwidth
64 \-textDisplay                          false \-enableH245tunneling
true \-enableCallAlerting                 false \-GKAddressText
false \-enableTos                         false \-useRegistrationParameters
false \-enableFastStart                   true \-bandwidthText
false \-ckHexUserUserData                 false \-rasTimeout
4 \-enableCallProceeding                  false \-enableRas
false \-enableKeepAliveReg               false \-GKAddress
"198.18.80.80" \-tosVal                    0 \-displayData
"Ixia\[00-\]" \-terminalType              50 \-H245Version
9 \-autoRegisterToGk                     false \-userUserData
"1234\[00-\]" \-enableH323                true
```

### SEE ALSO

[VoIP H323 Peer Agent](#)

## Simultaneous Capability Value Set List

VoIP H323 Simultaneous Capability Value Set List

### SYNOPSIS

```
set Activity_VoIPH323Peer1 [$Traffic1_Network1 activityList.appendItem \-
protocolAndType                "VoIPH323 Peer" ]$Activity_VoIPH323Peer1
agent.config \ $Activity_VoIPH323Peer1 agent.pm.terminalCapabilitySet.config \ $Activ-
ity_VoIPH323Peer1 agent.p-
m.terminalCapabilitySet.simultaneousCapabilityList.appendItem
```

### DESCRIPTION

Helps to configure the simultaneous capability list.

### SUBCOMMANDS

None.

### OPTIONS

id

Indicates the id of the simultaneous capability name. Default= "SimultaneousCapabilityName"

refCount

The reference count that is used to deallocate objects which are no longer referenced. Default= 0

simultaneousCapabilityName

The name of the simultaneous capability list. Default= "Default\_Simultaneous\_Capability"

### EXAMPLE

```
$Activity_VoIPH323Peer1
agent.pm.simultaneousCapabilitySetList.simultaneousCapabilityValueSetList.appendItem
\
-id "SimultaneousCapability" \
-refCount 0 \
-simultaneousCapabilityName "Default_Simultaneous_Capability"
```

### SEE ALSO

[Terminal Capability Set](#)

## Alternative Capability List

VoIP H323 Alternative Capability List

### SYNOPSIS

```
set Activity_VoIPH323Peer1 [$Traffic1_Network1 activityList.appendItem \-
protocolAndType "VoIPH323 Peer" ]$Activity_VoIPH323Peer1
agent.config \ $Activity_VoIPH323Peer1 agent.p-
m.sim-
ultaneousCapabilitySetList.simultaneousCapabilityValueSetList.alternativeCapabilityList.append
\
```

### DESCRIPTION

Configures the alternative capability list.

### SUBCOMMANDS

None.

### OPTIONS

id

Indicates the id of the alternative capability name. Default= "AlternativeCapabilityName"

alternativeCapabilityName

The name of the alternative capability list. Default= "Default\_Alternative\_Capability"

### EXAMPLE

```
$Activity_VoIPH323Peer1 agent.p-
m.sim-
ultaneousCapabilitySetList.simultaneousCapabilityValueSetList.alternativeCapabilityList.append
\
```

```
-id "AlternativeCapabilityName" \
-alternativeCapabilityName "Default_Alternative_Capability"
```

### SEE ALSO

[Simultaneous Capability Value Set List](#)

## Alternative Capability

VoIP H323 Alternative Capability

### SYNOPSIS

```
set Activity_VoIPH323Peer1 [$Traffic1_Network1 activityList.appendItem \-  
protocolAndType           "VoIPH323 Peer" ]$Activity_VoIPH323Peer1  
agent.config \ $Activity_VoIPH323Peer1 agent.pm.alternativeCapability.config \
```

### DESCRIPTION

Configures the alternative capability descriptors.

### SUBCOMMANDS

None.

### OPTIONS

alternativeCapabilityName

The name of the alternative capability. Default= "".

refCount

The reference count that is used to deallocate objects which are no longer referenced. Default= 0.

### EXAMPLE

```
$Activity_VoIPH323Peer1 agent.pm.alternativeCapability.config \-  
alternativeCapabilityName           "" \-refCount  
0
```

### SEE ALSO

[VoIP H323 Peer Agent](#)

## Dial Plan

VoIP H323 Peer Dial Plan

### SYNOPSIS

```
set Activity_VoIPH323Peer1 [${Traffic1_Network1 activityList.appendItem \-
protocolAndType                "VoIPH323 Peer" ]$Activity_VoIPH323Peer1
agent.config \${Activity_VoIPH323Peer1 agent.pm.dialPlan.config \
```

### DESCRIPTION

The Dial Plan object configures the registration names, phone numbers, and source, destination, and transfer addresses for the channels/phones emulated by the VoIP H323 Peer activity.

### SUBCOMMANDS

None.

### OPTIONS

The options for this command are configured and read using the standard `config`, `cget`, and `getOption` subcommands defined in the `ixConfig` command.

`_useSPB`

Method used to select phone number.

Value	Usage
0	Use the phone number specified by pattern.
1	Use the phone number specified by Phonebook entry.

**Note:** This options appears in the generated tcl code only if the test configuration contains a reference to a Phonebook entry (`_useSPb=1`). The generated Tcl script will run only on the machine it has been generated on and only if the corresponding Phonebook entry has not yet been deleted since the generation of the Tcl code.

`_symDestStr`

String identifying the VoIP H323 Peer that is the destination for traffic from this VoIP H323 Peer activity. Default="None".

`_sPhone`

If `_useSPb` is 0, this option specifies the phone number. You can use sequence generators in this field to generate multiple phone numbers. See the sequence generator appendix. Default="160[00000000-]".

`_sBp`

If `_useSPb` is 1, this option specifies the phone book entry name.  
Default="&lt;None&gt;".

`srcPhoneType`

Indicates the type of source phone number.

Value	Usage
0	Specified by <code>sourcePhoneSpecified</code> as digits (default).
1	Specified by <code>sourcePhoneBook</code> as a file name.

`_dBp`

If `_useDPb` is 1, this option specifies the phone book file name.  
Default="&lt;None&gt;".

`ovrDestPhone`

Enables overriding of phone number from the destination VoIP H323 Peer.  
Default= False.

`_dPhone`

If `_useDPb` is 0, this option specifies the phone number. Default="170[00000000-]".

`_useDPb`

Method used to select the phone number used to override destination phone number.

Value	Usage
0 (default)	Specify pattern.
1	Specify Phonebook entry.

**Note:** This option appears in the generated tcl code only if the test configuration contains a reference to a Phonebook entry (`useDestPhoneBook=1`). The generated Tcl script will run only on the machine it has been generated on and only if the corresponding Phonebook entry has not yet been deleted since the generation of the Tcl code.

`destPhoneType`

Method used to select phone number.

Value	Usage
0 (default)	Use the phone number specified by pattern.
1	Use the phone number specified by Phonebook entry.



**Note:** This options appears in the generated tcl code only if the test configuration contains a reference to a Phonebook entry (`useSourcePhoneBook=1`). The generated Tcl script will run only on the machine it has been generated on and only if the corresponding Phonebook entry has not yet been deleted since the generation of the Tcl code.

### EXAMPLE

```
$Activity_VoIPH323Peer1 agent.pm.dialPlan.config \-_useSPb
0 \-symDestStr                "Traffic2_VoIPH323Peer2" \-_sPhone
"160\[00000000-\]" \-_sBp                "&lt;None&gt;" \-
srcPhoneType                0 \-_dBp
"&lt;None&gt;" \-ovrDestPhone                false \-_dPhone
"170\[00000000-\]" \-_useDPb                0 \-destPhoneType
0
```

### SEE ALSO

[VoIP H323 Peer Agent](#)

## Terminal Capability Set

VoIP H323 Terminal Capability Set

### SYNOPSIS

```
set Activity_VoIPH323Peer1 [$Traffic1_Network1 activityList.appendItem \-  
protocolAndType           "VoIPH323 Peer" ] \${Activity_VoIPH323Peer1  
agent.config \${Activity_VoIPH323Peer1 agent.pm.terminalCapabilitySet.config \
```

### DESCRIPTION

Configures the terminal capability descriptors.

### SUBCOMMANDS

None.

### OPTIONS

defaultCodecIndex

Helps to edit the default codex index. Default = 0.

defaultCodecName

Helps to edit the default codec name. Default = "".

### EXAMPLE

```
\${Activity_VoIPH323Peer1 agent.pm.terminalCapabilitySet.config \-defaultCodecIndex  
0 \-defaultCodecName           ""
```

### SEE ALSO

[VoIP H323 Peer Agent](#)

## Simultaneous Capability List

VoIP H323 Simultaneous Capability List

### SYNOPSIS

```
set Activity_VoIPH323Peer1 [ $Traffic1_Network1 activityList.appendItem \-
protocolAndType                "VoIPH323 Peer" ] \ $Activity_VoIPH323Peer1
agent.config \ $Activity_VoIPH323Peer1 agent.pm.terminalCapabilitySet.config \ $Activ-
ity_VoIPH323Peer1 agent.p-
m.terminalCapabilitySet.simultaneousCapabilityList.appendItem
```

### DESCRIPTION

Helps to configure the simultaneous capability list.

### SUBCOMMANDS

None.

### OPTIONS

id

Indicates the id of the simultaneous capability name. Default= "SimultaneousCapabilityName".

simultaneousCapabilityName

The name of the simultaneous capability list. Default= "Default\_Simultaneous\_Capability".

### EXAMPLE

```
$Activity_VoIPH323Peer1
agent.pm.terminalCapabilitySet.simultaneousCapabilityList.appendItem \
-id "SimultaneousCapabilityName" \
-simultaneousCapabilityName"Default_Simultaneous_Capability"
```

### SEE ALSO

[Terminal Capability Set](#)

## Scenario Settings

### VoIP H323 Peer Scenario Settings

#### SYNOPSIS

```
set Activity_VoIPH323Peer1 [${Traffic1_Network1 activityList.appendItem \-  
protocolAndType "VoIPH323 Peer" ]$Activity_VoIPH323Peer1  
agent.config \${Activity_VoIPH323Peer1 agent.pm.scenarioSettings.config \
```

#### DESCRIPTION

Scenario Settings specifies the test scenario file that will be used by the Tcl script.

#### SUBCOMMANDS

None.

#### OPTIONS

The options for this command are configured and read using the standard `config`, `cget`, and `getOption` subcommands defined in the `ixConfig` command.

`scenarioFile`

The full path to the test scenario file for the activity.

`activeScenarioChannel`

Test scenario channel (0-based index) that is associated with the VoIP H323 Peer activity.  
Default=0.

#### EXAMPLE

```
Activity_VoIPH323Peer1 agent.pm.scenarioSettings.config \  
-scenarioFile"C:\\Documents and Settings\\supanda\\Desktop \  
\\H323-rxf\\Simple H323 calls with FirstConnect..tst" \  
-activeScenarioChannel0
```

#### SEE ALSO

[VoIP H323 Peer Agent](#)

## Custom Parameters

VoIPH323 Peer CustomParameters

### SYNOPSIS

```
set Activity_VoIPH323Peer1 [$Traffic1_Network1 activityList.appendItem \-
protocolAndType                "VoIPH323 Peer" ]$Activity_VoIPH323Peer1
agent.config \ $Activity_VoIPH323Peer1 customParameters.config \
```

### DESCRIPTION

CustomParameters configures the settings for the BHCA objective for VoIPH323Peer activities. This options in this object correspond to the controls on the Custom Parameters tab for a NetTraffic/ActivityLink in the Timeline and Objective branch of the Test Configuration tree in the GUI.

**Note:** The CustomParameters class has to be configured alongside the CustomActivityLinkSettings class that implements the same functionality.

**Note:** CPS objective related settings are not available for VoIPH323 Peer activities.

### SUBCOMMANDS

None.

### OPTIONS

bhcaObjectiveValue

The BHCA test objective value. Default="80000".

bhcaType

Determines how the BHCA objective will be met: by specifying the talk time or the number of channels.

Value	Usage
0 (default)	BHCA will be met by specifying the talk time. Specify the talk time in talkTime.
1	BHCA will be met by specifying the number of channels. Specify the number of channels in channelsNo.

talkTime

If bhcaType is 0, this option specifies the Talk Time that will be used to attain the BHCA test objective. Default="40000".

channelsNo

If bhcaType is 1, this option specifies the number of channels that will be used to attain the BHCA test objective. Default="100".

interCallDuration

Inter-call duration. Default="4000".

callSetupTime

Estimated call setup time. Default="500".

callTeardownTime

Estimated call teardown time. Default="500".

### EXAMPLE

```
$Activity_VoIPH323Peer1 customParameters.config \-talkTime
40000 \-cpsObjectiveValue                100 \-cpsType
0 \-cpsInterCallDuration                 150 \-channelsNo
1 \-cpsTalkTime                          750 \-cpsOverheadTime
100 \-cpsChannelsNo                      100 \-bhcaType
0 \-callTeardownTime                    500 \-interCallDuration
4000 \-bhcaObjectiveValue                80000 \-callSetupTime
500
```

### SEE ALSO

[VoIP H323 Peer Agent](#)

## VoIP MGCP

The IxLoad VoIP MGCP Peer Tcl API consists of VoIP GW and VOIP MGC agents with separate APIs for configuring each major aspect of the agent's functionality.

There is also an Endpoint Agent with separate configuration parameters.

- When defined on a GW activity, an Endpoint agent refers to endpoints present on that gateway.
- When defined on a CA activity, an Endpoint agent refers to endpoints managed by that controller.

## Limitations

The following restrictions and limitations of the VoIP MGCP Peer API exist:

- Individual VoIP MGCP script functions can not be added and edited from the Tcl API. Instead, you must add and configure the test scenario in the Scenario Editor, then save the test scenario file and pass it as an argument to the `ScenarioSettings` API class.

## VoIP MGCP Peer API Commands

The IxLoad VoIP MGCP Peer API commands are organized as shown in the figure below.

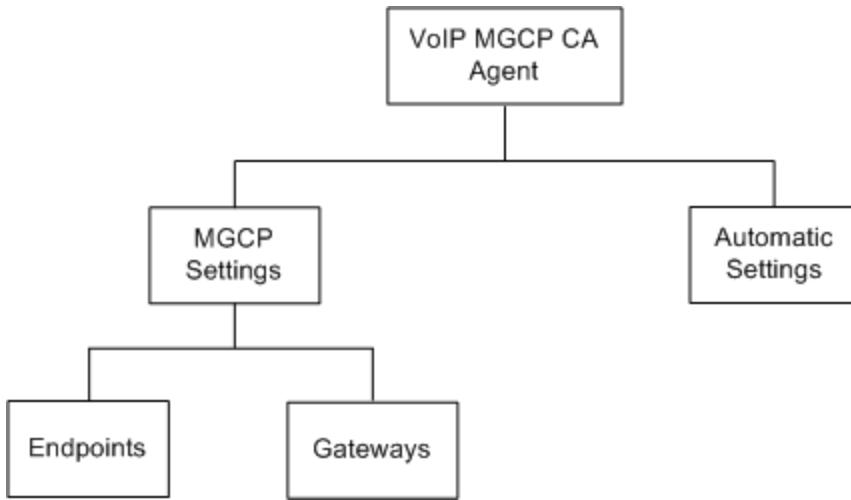
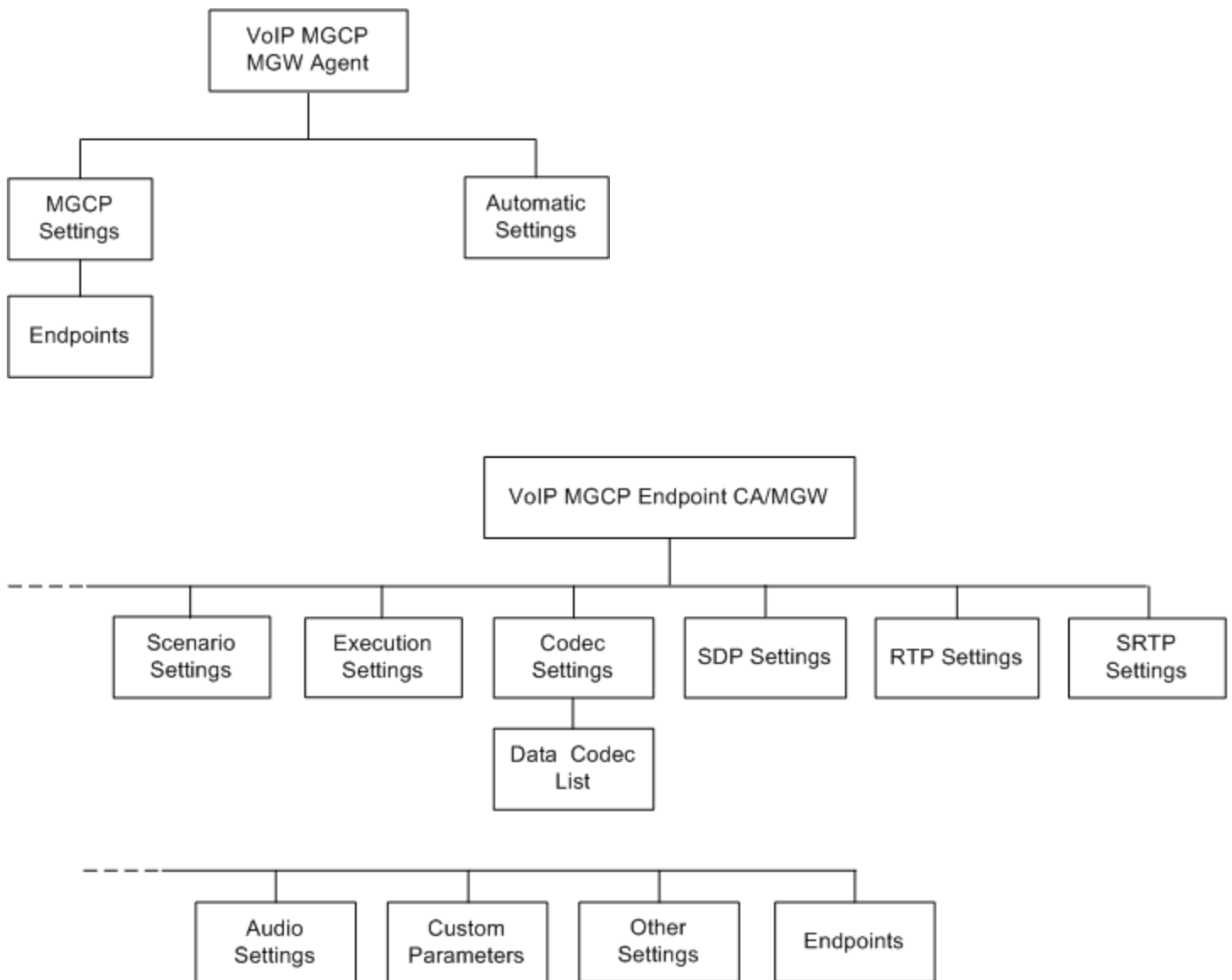

Figure 30-2. VoIP MGCP GW Peer API Structure





## VoIP MGCP CA/MGW Peer API Objects

The table below summarizes the VoIP MGCP CA/GW API objects.

Object	Description
VoIP MGCP CA Agent	Top-level object defining the VoIP CA activity.
VoIP MGCP GW Agent	Top-level object defining the VoIP GW activity.
MGCP Settings	Configures the MGCP Settings separately for the Media Gateway or Media Controller. Also contains the list of all endpoint groups associated with the gateway or controller.
Automatic Settings	Sets the automatic functionality parameters for the MGC and GW side.
Endpoints	Contains the list of all endpoint groups associated with the gateway or controller. When a new Endpoint is added, a new activity is added in the same NetTraffic.
Gateways	The list of CA-controlled Gateways.

## VoIP MGCP Endpoint Peer API Objects

The table below summarizes the MGCP Endpoint API objects.

Object	Description
VoIP MGCP Endpoint Agent	Top-level object defining the VoIP MGCP CA/GW Endpoint agent activity.
Scenario Settings	This object corresponds to the Scenario Settings GUI tab and enables the selection of the scenario channel.
Execution Settings	Run-time test configuration; corresponds to the Execution Settings GUI tab.
Endpoints	The list of simulated endpoint groups.
Codec Settings	List of <code>Data Codecs</code> and <code>Codecs</code> objects.
Data Codecs	Data codec with parameters.
Codecs	Audio codecs with parameters.
SDP Settings	The SDP settings for the simulated endpoints.
RTP Settings	RTP transport configuration corresponding to the RTP Settings GUI tab.
SRTP Settings	SRTP settings corresponding to the SRTP GUI tab.
Other Settings	VoIP MGCP Peer miscellaneous parameters which corresponds to the Other Settings GUI tab.
Custom Activity Link Settings, CustomParameters	BHCA objective configuration which corresponds to the Custom Parameters GUI tab.

## MGCP GW Agent

VoIP MGCPGW Agent

### SYNOPSIS

```
set Activity_MGCPGW1 [$Traffic1_Network1 activityList.appendItem \-protocolAndType
"MgcpGw Peer" ]
```

### DESCRIPTION

A VoIP MGCPGW agent is added to the `agentList` option of the `ixConfig` object using the `appendItem` subcommand from the `ixConfigSequenceContainer` command. Other `ixConfigSequenceContainer` subcommands may be used to modify the `agentList`. See the following example:

```
set Activity_MGCPGW1 [$Traffic1_Network1 activityList.appendItem \-protocolAndType
"MgcpGw Peer" ]
```

```
$Activity_MGCPGW1 config \-enable 1 \-name
"MGCPGW1"
```

```
$$Activity_MGCPGW1 agent.config \-cmdListLoops 0
```

Each member of the list, however may be separately addressed and modified using the `ixConfig` subcommands. For example, the first agent uses an index of 0 and its name may be modified by:

```
$Activity_MGCPGW1 agent(0).config -name "MgcpGw Peer new"
```

### SUBCOMMANDS

None.

### OPTIONS

`enable`

Enables the use of this agent. (Default = 1).

`name`

The name associated with this object, which must be set at object creation time.

### STATISTICS

The available MGCP statistics are listed in the table below.

Statistic	Description	Applies To
<b>MGCP Transactions</b>		

Transactions Sent	The number of transactions sent from test start.	MGW, CA	
Transactions Received	The number of transactions received from test start.	MGW, CA	
Transactions Failed	The number of transactions initiated and failed from test start.	MGW, CA	
<b>MGCP Transaction Rates</b>			
Transactions Sent/sec	The number of transactions sent per second from test start.	MGW, CA	
Transactions Received/sec	The number of transactions received per second from test start.	MGW, CA	
Transactions Failed/sec	The number of transactions failed per second from test start.	MGW, CA	
<b>MGCP Transaction Times</b>			
Transactions Sent Duration (ms) (min, avg, max)	The min/max/average duration of sent transactions.	MGW, CA	
Transactions Received Duration (ms) (min, avg, max)	The min/max/average duration of sent transactions.	MGW, CA	
<b>MGCP Calls</b>			
Calls Attempted	The number of attempted calls since test start. This statistic is incremented when the phone number digits are dialed.	MGW, CA	
Calls Received	The number of received calls since test start. This statistic is incremented when a receiver connection becomes <i>sendreceive</i> .	MGW, CA	
Calls Connected	The number of connected calls since test start. This statistic is incremented when a connection state becomes <i>sendreceive</i> following an originated call.	MGW, CA	
Calls Answered	The number of calls since test start that were not answered. This statistic is incremented when a receiver endpoint sends an RQNT (S:L/rg).	MGW, CA	

Calls Busy	The number of calls since test start that resulted in an endpoint busy condition. This statistic is incremented when an originating call is in <i>hd</i> state.	MGW, CA
Calls Rejected	The number of calls since test start that were rejected. This statistic is incremented when a delete call message is received before the call is connected.	MGW, CA
<b>MGCP Call Times</b>		
MGCP Call Setup Time for MGW (ms) (min, avg, max)	The min/max/average call setup time from the MGW perspective. This is defined as the time duration between the first digit is sent and the moment when the MGCP connection becomes <i>sendrecv</i> .	MGW
MGCP Call Setup Time for CA (ms) (min, avg, max)	The min/max/average call setup time from the CA perspective. This is the time duration between the moment the RQNT with <i>rg</i> (or <i>wt</i> ) is sent and the moment when the MGCP connection becomes <i>sendrecv</i> .	CA
MGCP End Call Time MGW (ms) (min, avg, max)	The min/max/average end call call time from the MGW perspective. This is the duration between the DLCX is received and the NTFY ( <i>hu</i> ) is sent, or inversed flow.	MGW
MGCP End Call Time CA (ms) (min, avg, max)	The min/max/average end call call time from the CA perspective. This is the time duration between the DLCX is sent and the NTFY ( <i>hu</i> ) is received.	CA
MGCP Post Dial Delay (ms) (min, avg, max)	The min/max/average post dial delay. This is defined as the time between the last digit is sent and moment when the MGCP connection becomes <i>sendrecv</i> .	MGW
MGCP Post Pickup Delay (ms) (min, avg, max)	The min/max/average post pickup delay. This is defined as the time duration between the NTFY ( <i>hd</i> ) sent and the moment when the MGCP connection becomes <i>sendrecv</i> .	MGW
MGCP Media Delay Tx (ms)	The transmitting side media delay. This is the time duration between the moment the call setup is finished and the moment the first RTP packet is received.	MGW

MGCP Media Delay Rx (ms)	The receiving side media delay. The time duration between the moment the call setup is finished and the moment the first RTP packet is received.	CA	
MGCP Total Call Time (min, avg, max)	The min/max/average total call time, which includes the call setup time, talk time, and end call time. This is defined as the time duration between the NTFY (hd) sent/received and the moment when the End Call is finished (NTFY(hu) after DLCX, or DLCX after NTFY(hu)).	MGW, CA	
<b>MGCP Call Rates</b>			
Calls Attempted/sec	The number of attempted calls per second since test start.	MGW, CA	
Calls Received/sec	The number of received calls per second since test start.	MGW, CA	
Calls Connected/sec	The number of connected calls per second since test start.	MGW, CA	
<b>MGCP Commands</b>			
MGCP RSIP Sent	Number of MGCP RSIP commands sent by the MGW since test start, including retransmitted commands.	MGW	
MGCP NTFY Sent	Number of MGCP NTFY commands sent by the MGW since test start, including retransmitted commands.	MGW	
MGCP DLCX Sent	Number of MGCP DLCX commands sent by the CA since test start, including retransmitted commands.	CA	
MGCP RQNT Received	Number of MGCP RQNT commands received by the MGW since test start, including retransmitted commands.	MGW	
MGCP CRCX Received	Number of MGCP CRCX commands received by the MGW since test start, including retransmitted commands.	MGW	
MGCP MDCX Received	Number of MGCP MDCX commands received by the MGW since test start, including retransmitted commands.	MGW	
MGCP DLCX Received	Number of MGCP DLCX commands received by the MGW since test start, including retransmitted commands.	MGW	
MGCP AUCX Received	Number of MGCP AUCX commands received by the MGW since test start, including retransmitted commands.	MGW	

MGCP AUEP Received	Number of MGCP AUEP commands received by the MGW since test start, including retransmitted commands.	MGW	
MGCP EPCF Received	Number of MGCP EPCF commands received by the MGW since test start, including retransmitted commands.	MGW	
MGCP RSIP Received	Number of MGCP RSIP commands received by the MGW since test start, including retransmitted commands.	MGW	
MGCP NTFY Received	Number of MGCP NTFY commands received by the CA since test start, including retransmitted commands.	CA	
MGCP DLCX Received	Number of MGCP DLCX commands received by the MGW since test start, including retransmitted commands.	MGW	
MGCP RQNT Sent	Number of MGCP RQNT commands sent by the CA since test start, including retransmitted commands.	CA	
MGCP CRCX Sent	Number of MGCP CRCX commands sent by the CA since test start, including retransmitted commands.	CA	
MGCP MDCX Sent	Number of MGCP MDCX commands sent by the CA since test start, including retransmitted commands.	CA	
MGCP DLCX Sent	Number of MGCP DLCX commands sent by the CA since test start, including retransmitted commands.	CA	
MGCP AUCX Sent	Number of MGCP AUCX commands sent by the CA since test start, including retransmitted commands.	CA	
MGCP AUEP Sent	Number of MGCP AUEP commands sent by the CA since test start, including retransmitted commands.	CA	
MGCP EPCF Sent	Number of MGCP EPCF commands sent by the CA since test start, including retransmitted commands.	CA	
<b>MGCP Responses</b>			
MGCP 1xx Received	The number of 1xx responses received since test start, including retransmissions.	MGW, CA	
MGCP 1xx Sent	The number of 1xx responses sent since test start, including retransmissions.	MGW, CA	
MGCP 2xx Received	The number of 2xx responses received since test start, including retransmissions.	MGW, CA	



MGCP 2xx Sent	The number of 2xx responses sent since test start, including retransmissions.	MGW, CA	
MGCP 4xx Received	The number of 4xx responses received since test start, including retransmissions.	MGW, CA	
MGCP 4xx Sent	The number of 4xx responses sent since test start, including retransmissions.	MGW, CA	
MGCP 5xx Received	The number of 4xx responses received since test start, including retransmissions.	MGW, CA	
MGCP 5xx Sent	The number of 5xx responses sent since test start, including retransmissions.	MGW, CA	
MGCP 5xx Received	The number of 5xx responses received since test start, including retransmissions.	MGW, CA	
<b>MGCP Messages</b>			
MGCP msgs tx	The number of sent MGCP messages since test start.	MGW, CA	
MGCP msgs rx	The number of received MGCP messages since test start.	MGW, CA	
MGCP matched msgs	The number of matched MGCP messages since test start.	MGW, CA	
MGCP commands tx	The number of sent MGCP commands since test start.	MGW, CA	
MGCP commands rx	The number of received MGCP commands since test start.	MGW, CA	
MGCP responses tx	The number of sent MGCP responses since test start.	MGW, CA	
MGCP responses rx	The number of received MGCP responses since test start.	MGW, CA	
<b>MGCP Retransmissions TX</b>			
MGCP retransmitted messages sent	The percentage of retransmitted messages sent.	MGW, CA	

MGCP messages sent	The percentage of distinct messages sent, not including retransmissions sent.	MGW, CA	
<b>MGCP Retransmissions RX</b>			
MGCP retransmitted messages received	The percentage of retransmitted messages received.	MGW, CA	
MGCP messages received	The percentage of distinct messages received, not including received retransmissions.	MGW, CA	
<b>MGCP Restart Duration</b>			
MGCP RSIP-Restart Duration	The duration of MGW restarts with a <i>restart</i> reason. This is the time elapsed between the sending of an RSIP (reason= <i>restart</i> ) command and the receiving of a 200 OK response.	MGW	
MGCP RSIP-Forced Duration	The duration of MGW restarts with a <i>forced</i> reason. This is the time elapsed between the sending of an RSIP (reason= <i>forced</i> ) command and the receiving of a 200 OK response.	MGW	
<b>MGCP Active Calls/Transactions</b>			
Number of active calls	The number of active calls.	MGW, CA	
Number of active transactions	The number of active transactions.	MGW, CA	
<b>MGCP Errors</b>			
MGCP Call Flow Errors	The number of call flow errors. Such an error occurs when: <ul style="list-style-type: none"> <li>• A gateway has no IP assigned;</li> <li>• A script function exits on the Error output</li> </ul>	MGW, CA	
MGCP Parser Errors	The number of MGCP parser errors. This statistic is incremented when a MGCP message is received with the first line malformed. When a parser error occurs, the message is not dispatched any more.	MGW, CA	
MGCP Parser Warnings	The number of MGCP parser warning. This statistic is incremented when a MGCP message is received with a malformed line. When a parser warning occurs, the message is still dispatched.		

MGCP SDP Errors	The number of SDP errors. This statistic is incremented in any of the following situations: <ul style="list-style-type: none"> <li>• The SDP body cannot be constructed (invalid or empty custom SDP);</li> <li>• The SDP parsing error occurred;</li> <li>• The SDP negotiation failed;</li> <li>• The SDP Glare;</li> </ul>	MGW, CA	
MGCP RTP Errors	The number of RTP errors.	MGW, CA	
MGCP Transport Errors	The number of errors resulting in the incapability to send a message.	MGW, CA	
MGCP Protocol Errors	The number of MGCP protocol errors. This statistic is incremented in any of the following situations: <ul style="list-style-type: none"> <li>• An RSIP with restart method is received for a gateway that is already restarted;</li> <li>• An RSIP with force method is received for a gateway that is already force-restarted;</li> <li>• An invalid message is intended to be sent;</li> <li>• A message with an incompatible version is received;</li> <li>• An RSIP message is received on a gateway;</li> <li>• An inappropriate parameters has been received for a certain endpoint state;</li> <li>• An invalid message is received (with not allowed parameters for that message);</li> </ul>	MGW, CA	
MGCP Timeout Errors	The number of MGCP timeout errors. This statistic is incremented when a Wait-type script function timeout period has expired or when the transaction timeout period has expired.	MGW, CA	
MGCP Unknown Phone No	The number of errors having an unknown destination phone number as a cause. This statistic is incremented only on the Call Agent when the dialed phone number received through a NTFY command is not defined in the Call Agent.	CA	
MGCP Unknown Endpoint	The number of errors having a failed endpoint resolution as cause. This statistic is incremented when the GW/CA received a MGCP command for an endpoint that is not defined on the gateway/call agent.	MGW, CA	

MGCP Incorrect ConnectionId	The number of errors caused by an incorrect connection id parameter. This statistic is incremented on the Call Agent when it receives a ConnectionId (I) parameter in a MDCX or DLCX command and that connection has not been created.		
MGCP Incorrect CallId	The number of errors caused by an incorrect call id parameter. This statistic is incremented on the Gateway/Call Agent when it receives a CallId (C) parameter in a MDCX, CRCX, or DLCX command and there is no connection created for that call id.		
MGCP Unsupported Functionality	This statistic is incremented when the SDP information that is intended to be sent references a connection that has already been deleted.		
MGCP Unknown Restart Method	This statistic is incremented whenever a RSIP message is received with an unknown RM parameter value.		
MGCP Unknown Gateway IP	This statistic is incremented every time a Call Agent tries to send a message to a gateway whose IP cannot be determined.		

**EXAMPLE**

```
##### Activity MGCPGW1 of NetTraffic
Traffic1@Network1#####set Activity_
MGCPGW1 [$Traffic1_Network1 activityList.appendItem \-protocolAndType
"MgcpGw Peer" ]
```

```
$Activity_MGCPGW1 config \-enable 1 \-name
"MGCPGW1"
```

```
$Activity_MGCPGW1 agent.config \-cmdListLoops 0
```

**SEE ALSO**

[ixConfig](#)

## MGCP Settings (GW)

VoIP MGCP simulated GW settings

### SYNOPSIS

```
set Activity_MGCPGW1 [$Traffic1_Network1 activityList.appendItem \-protocolAndType
"MgcpGw Peer" ]$Activity_MGCPGW1 config \ $Activity_MGCPGW1 agent.p-
m.mgcpSettings.config
```

### DESCRIPTION

Simulates the source address in MGCP messages and contains the list of all endpoint groups provisioned on the GW.

### SUBCOMMANDS

Endpoints.

### OPTIONS

The options for this command are configured and read using the standard `config`, `cget`, and `getOption` subcommands defined in the `ixConfig` command.

`port`

The MGCP listening port. `Default = "2427"`.

`callAgent`

The address of the controlling CA as a symbolic link or as an IP address.

`enableTos`

Enables use of TOS/DSCP settings. When `enableTos` is configured to 1, the `tos` option specifies the TOS/DSCP value.

0 = TOS disabled (default)

1= TOS enabled

`tosVal`

If `enableTos` is configured 1, this option sets the value of the TOS bits.

Value	Usage
0 (default)	Best Effort (0x00)
1	Class 1 (0x20)
2	Class 2 (0x40)

3	Class 3 (0x60)
4	Class 4 (0x80)
5	Express Forwarding (0xA0)
6	Control (0xC0)

domainName

The MGCP GW domain name. Sequence generator expressions are supported, for example, gw[001-100].ixialab.com which defines a number of 100 hosts, gw001 through gw100.

mgcpVersion

The currently supported MGCP version.

ncsTgcpVersion

The currently supported NCS version.

udpMaxSize

The maximum UDP size for MGCP traffic.

ipPreference

The IP preference, IPv4 or IPv6.

### EXAMPLE

```
$Activity_MGCPGW1 agent.pm.mgcpSettings.config \-enableTos
false \-tosVal 0 \-domainName
"gw[001-100].ixialab.com" \-ncsTgcpVersion "NCS 1.0" \-
callAgent "Traffic2_MGCPA1" \-udpMaxSize
1470 \-mgcpActivitiesCount 0 \-ipPreference
0 \-mgcpVersion "1.0" \-port
"2427"
```

```
$Activity_MGCPGW1 agent.pm.mgcpSettings.endpoints.clear
```

### SEE ALSO

[VoIP MGCPGW Agent](#)

## Automatic Settings (GW)

VoIP MGCP GW automatic settings.

### SYNOPSIS

```
s$Activity_MGCPGW1 agent.pm.automaticSettings.config \
```

### DESCRIPTION

Defines automatic settings for the MGCP GW.

### SUBCOMMANDS

None.

### OPTIONS

The options for this command are configured and read using the standard `config`, `cget`, and `getOption` subcommands defined in the `ixConfig` command.

`rsipAtBegin`

If configured to `true`, an RSIP command is sent at the test start.

`restartDelay`

If `rsipAtBegin` is configured `true`, this specifies a restart delay value (Default=0).

`rsipAtEnd`

If configured to `true`, an RSIP command is sent at the test end.

`retransmit`

If configured to `true`, this option enables retransmissions of message for whom a reply has not been received.

`ignoreRecvRetransmit`

If configured `true`, retransmissions are ignored.

`retransmTimerType`

Specifies a timer type as either of the following:

- 0 = A timer value is specified
- 1 = The timer value is calculated internally according to RFC 3435

`retransmTimerDuration`

If `retransmTimerType` is configured 0, this specifies a retransmission timer value (default = 3000 ms).

`transactionTimeout`

Specifies a transaction timeout (default = 50000 ms).

waitTimeout

Specifies a wait timeout (default = 50000 ms).

**EXAMPLE**

```
$Activity_MGCPGW1 agent.pm.automaticSettings.config \-restartDelay  
"0" \-ignoreRecvRetransmit true \-rsipAtBegin  
true \-transactionTimeout 50000 \-retransmTimerType  
0 \-rsipAtEnd true \-waitTimeout  
50000 \-retransmTimerDuration 3000 \-retransmit  
true
```

**SEE ALSO**

[MGCP Settings \(GW\)](#)



## Endpoints

VoIP MGCP GW endpoint group settings.

### SYNOPSIS

```
$Activity_MGCPGW1 agent.pm.mgcpSettings.endpoints.appendItem
```

### DESCRIPTION

Defines the properties of an endpoint group provisioned on the GW.

### SUBCOMMANDS

None.

### OPTIONS

The options for this command are configured and read using the standard `config`, `cget`, and `getOption` subcommands defined in the `ixConfig` command.

`id`

Indicates the endpoint group id.

`endpoint`

Indicates the endpoint group name.

**NOTE:** Sequence generator expressions are supported, such as for example, `aaln[1-3]`.

`enabled`

Indicates if the endpoint group is active (`true`) or not (`disabled = false`).

`activity`

The name of the corresponding Endpoint activity.

### EXAMPLE

```
$Activity_MGCPGW1 agent.pm.mgcpSettings.endpoints.appendItem \-id
"Endpoint" \-endpoint                "aaln1" \-enabled
true \-activity                      "Endpoint1"
```

### SEE ALSO

## MGCP CA Agent

VoIP MGCP CA Agent

### SYNOPSIS

```
set Activity_MGCPA1 [$Traffic2_Network2 activityList.appendItem \-protocolAndType
"MgcpCa Peer" ]
```

```
$Activity_MGCPA1 config \-enable 1 \-name
"MGCPA1"
```

### DESCRIPTION

A VoIP MGCP CA agent is added to the `agentList` option of the `ixConfig` object using the `appendItem` subcommand from the `ixConfigSequenceContainer` command. Other `ixConfigSequenceContainer` subcommands may be used to modify the `agentList`. See the following example:

```
set Activity_MGCPA1 [$Traffic1_Network1 activityList.appendItem \-protocolAndType
"MgcpCa Peer" ]
```

```
$Activity_MGCPA1 config \-enable 1 \-name
"MGCPA1"
```

```
$$Activity_MGCPA1 agent.config \-cmdListLoops 0
```

Each member of the list, however may be separately addressed and modified using the `ixConfig` subcommands. For example, the first agent uses an index of 0 and its name may be modified by:

```
$Activity_MGCPA1 agent(0).config -name "MgcpCa Peer new"
```

### SUBCOMMANDS

None.

### OPTIONS

`enable`

Enables the use of this agent. (Default = 1).

`name`

The name associated with this object, which must be set at object creation time.

### EXAMPLE

```
##### Activity MGCPA1 of NetTraffic
Traffic1@Network1#####set Activity_
MGCPA1 [$Traffic1_Network1 activityList.appendItem \-protocolAndType
"MgcpCa Peer" ]
```

```
$Activity_MGCPA1 config \-enable 1 \-name
```

"MGCPA1"

**SEE ALSO**

ixConfig

## MGCP Settings (CA)

### VoIP MGCP Simulated CA settings

#### SYNOPSIS

```
$Activity_MGCPCA1 agent.pm.mgcpSettings.config \
```

#### DESCRIPTION

Simulates the source address in MGCP messages, designates the MGCP CA settings. Also contains the list of all gateways and endpoint groups controlled by the CA.

#### SUBCOMMANDS

Endpoints, Gateways.

#### OPTIONS

The options for this command are configured and read using the standard `config`, `cget`, and `getOption` subcommands defined in the `ixConfig` command.

`port`

The MGCP CA listening port (default `2727`).

`mgcpVersion`

The currently supported MGCP version.

`ncsTgcpVersion`

The currently supported NCS version.

`enable Tos`

Enables use of TOS/DSCP settings. When `enableTos` is configured to 1, the `tos` option specifies the TOS/DSCP value.

0 = TOS disabled (default)

1 = TOS enabled

`tosval`

If `enableTos` is configured 1, this option sets the value of the TOS bits.

Value	Usage
0 (default)	Best Effort (0x00)
1	Class 1 (0x20)

2	Class 2 (0x40)
3	Class 3 (0x60)
4	Class 4 (0x80)
5	Express Forwarding (0xA0)
6	Control (0xC0)

useDigitMap

If configured true, a digit map is specified.

digitMap

The digit map to be send to the GW.

ipPreference

The IP address preference, IPv4 or IPv6.

udpMaxSize

The maximum UDP size for MGCP traffic.

### EXAMPLE

```
$Activity_MGCPA1 agent.pm.mgcpSettings.config \-enableTos
false \-tosVal 0 \-digitMap
"160xxxxxx" \-ipPreference 0 \-ncsTgcpVersion
"NCS 1.0" \-useDigitMap true \-mgcpActivitiesCount
0 \-udpMaxSize 1470 \-mgcpActivityId
0 \-mgcpVersion "1.0" \-port
2727
```

### SEE ALSO

[Endpoints](#)

[Gateways](#)

## Automatic Settings (CA)

VoIP MGCP CA automatic settings

### SYNOPSIS

```
s$Activity_MGCPCA1 agent.pm.automaticSettings.config \
```

### DESCRIPTION

The automated settings for the simulated CA.

### SUBCOMMANDS

None

### OPTIONS

The options for this command are configured and read using the standard `config`, `cget`, and `getOption` subcommands defined in the `ixConfig` command.

`rsipAtBegin`

If configured to `true`, an RSIP command is awaited at test start.

`restartDelay`

If `rsipAtBegin` is configured `true`, this specifies a restart delay value (Default=0).

`rsipAtEnd`

If configured to `true`, an RSIP command is awaited at test end.

`retransmit`

If configured to `true`, retransmissions are enabled.

`ignoreRecvRetransmit`

If configured `true`, retransmissions are ignored.

`retransmTimerType`

Specifies a timer type as either of the following:

- 0 = A timer value is specified
- 1 = The timer value is calculated internally according to RFC 3435

`retransmTimerDuration`

If `retransmTimerType` is configured 0, this specifies a retransmission timer value (default = 3000 ms).

`transactionTimeout`

Specifies a transaction timeout (default = 50000 ms).

---

waitTimeout

Specifies a wait timeout (default = 50000 ms).

**EXAMPLE**

```
$Activity_MGCPA1 agent.pm.automaticSettings.config \-restartDelay
"0" \-ignoreRecvRetransmit           true \-rsipAtBegin
true \-transactionTimeout             50000 \-retransmTimerType
0 \-rsipAtEnd                         true \-waitTimeout
50000 \-retransmTimerDuration         3000 \-retransmit
true
```

**SEE ALSO**

## Endpoints

VoIP MGCPCA controlled Endpoint settings.

### SYNOPSIS

```
$Activity_MGCPCA1 agent.pm.mgcpSettings.endpoints.clear$Activity_MGCPCA1 agent.p-  
m.mgcpSettings.endpoints.appendItem \
```

### DESCRIPTION

The properties of endpoint groups controlled by the CA.

### SUBCOMMANDS

None.

### OPTIONS

The options for this command are configured and read using the standard `config`, `cget`, and `getOption`s subcommands defined in the `ixConfig` command.

`id`

Indicates the endpoint group id.

`set`

Indicates the endpoint set id.

`endpoint`

Indicates the endpoint group name.

**NOTE:** Sequence generator expressions are supported, for example, `aaln[1-3]`.

`enabled`

Indicates if the endpoint group is active (`true`) or not (`disabled = false`).

`activity`

The name of the corresponding MGCP Endpoint activity.

### EXAMPLE

```
$Activity_MGCPCA1 agent.pm.mgcpSettings.endpoints.clear
```

```
$Activity_MGCPCA1 agent.pm.mgcpSettings.endpoints.appendItem \-id  
"Endpoint" \-set "Set1" \-endpoint  
"aaln1" \-enabled true \-activity  
"Endpoint2"
```



**SEE ALSO**

[Gateways](#)

## Gateways

VoIP MGCP controlled GW settings

### SYNOPSIS

```
$Activity_MGCPA1 agent.pm.mgcpSettings.gateways.clear
```

```
$Activity_MGCPA1 agent.pm.mgcpSettings.gateways.appendItem \
```

### DESCRIPTION

The properties of gateways controlled by the CA.

### SUBCOMMANDS

None.

### OPTIONS

The options for this command are configured and read using the standard `config`, `cget`, and `getOption` subcommands defined in the `ixConfig` command.

`id`

Indicates the gateway id.

`set`

Indicates the name of the endpoint set.

`endpoint`

Indicates the endpoint group name.

**NOTE:** Sequence generator expressions are supported, for example, `aaln[1-3]`.

`gateway`

A controlled gateway.

**NOTE:** Sequence generator expressions are supported, for example `gw[001-100].ixialab.com`.

### EXAMPLE

```
$Activity_MGCPA1 agent.pm.mgcpSettings.gateways.clear
```

```
$Activity_MGCPA1 agent.pm.mgcpSettings.gateways.appendItem \-id  
"Gateway" \-set "Set1" \-endpoint  
"aaln1" \-gateway "gw\[001-100\].ixialab.com"
```

**SEE ALSO**

[Endpoints](#)

## Scenario Settings

VoIP MGCP Endpoint scenario settings.

### SYNOPSIS

```
$Activity_Endpoint2 agent.pm.scenarioSettings.config \
```

### DESCRIPTION

Specifies the test scenario file and channel executed by the Tcl script.

### SUBCOMMANDS

None.

### OPTIONS

The options for this command are configured and read using the standard `config`, `cget`, and `getOption` subcommands defined in the `ixConfig` command.

`scenarioFile`

The full path to the test scenario file for the activity.

`activeScenarioChannel`

Test scenario channel (0-based index) that is associated with the VoIP MGCP Endpoint activity.  
Default=0.

### EXAMPLE

```
$Activity_Endpoint2 agent.pm.scenarioSettings.config \-scenarioFile  
"C:\\Documents and Settings\\user11\\Desktop\\MGCP rxf\\MBCP_BC_GWvsCA.tst" \-  
activeScenarioChannel 1
```

### SEE ALSO

## Execution Settings

VoIP MGCP Endpoint execution settings.

### SYNOPSIS

```
$Activity_Endpoint2 agent.pm.executionSettings.config \
```

### DESCRIPTION

This object defines the execution settings for the VoIP MGCP Endpoint.

### SUBCOMMANDS

None.

### OPTIONS

The options for this command are configured and read using the standard `config`, `cget`, and `getOption` subcommands defined in the `ixConfig` command.

`gracefulRampDown`

If enabled, allows the user to exit gracefully after a session. `Default=1`

`loopCount`

If `loopMode` is 1, this option defines the number of loops that the test performs.

`Default="1"`.

`loopPreDelay`

Delay before first loop (ms). `Default="0"`.

`loopMode`

Defines how many loops are executed for every voice channel corresponding to this activity.

Value	Description
0 (default)	Loop for the entire test duration.
1	Execute a number of loops. Specify the number of loops in <code>loopCount</code> .

`loopMidDelay`

Delay between loops (ms). `Default="0"`.

### EXAMPLE

```
$Activity_Endpoint2 agent.pm.executionSettings.config \-gracefulRampDown
true \-loopMidDelay 0 \-loopPreDelay
0 \-loopCount 1 \-loopMode
```

1

**SEE ALSO**

## Custom Activity Link Settings

VoIP MGCP Endpoint link settings.

### SYNOPSIS

```
$Activity_Endpoint1 agent.pm.customActivityLinkSettings.config \
```

### DESCRIPTION

This object defines the link settings for the VoIP MGCP Endpoint.

### SUBCOMMANDS

None.

### OPTIONS

The options for this command are configured and read using the standard `config`, `cget`, and `getOption` subcommands defined in the `ixConfig` command.

`bhcaObjectiveValue`

The BHCA test objective value. Default="80000".

`bhcaType`

Determines how the BHCA objective will be met: by specifying the talk time or the number of channels.

Value	Usage
0 (default)	BHCA will be met by specifying the talk time. Specify the talk time in <code>talkTime</code> .
1	BHCA will be met by specifying the number of channels. Specify the number of channels in <code>channelsNo</code> .

`talkTime`

If `bhcaType` is 0, this option specifies the Talk Time that will be used to attain the BHCA test objective. Default="40000".

`channelsNo`

If `bhcaType` is 1, this option specifies the number of channels that will be used to attain the BHCA test objective. Default="100".

`callSetupTime`

Estimated call setup time. Default="500".

`callTeardownTime`

Estimated call teardown time. Default="500".

interCallDuration

Inter-call duration. Default="4000".

cpsObjectiveValue

The Calls per Second test objective value. Default="100"

cpsType

Determines how the CPS objective will be met: by specifying the talk time or the number of channels.

Value	Usage
0 (default)	CPS objective will be met by specifying the talk time. Based on the the talk time value specified in <code>cpstalkTime</code> , the <code>cpsChannelsNo</code> value is computed.
1	CPS objective will be met by specifying the number of channels. Based on the the channels number value specified in <code>cpsChannelsNo</code> , the <code>cpstalkTime</code> value is computed.

cpsTalkTime

If `cpsType` is 0, this option specifies the Talk Time that will be used to attain the CPS test objective. Default="40000".

cpsChannelsNo

If `bhcaType` is 1, this option specifies the number of channels that will be used to attain the CPS test objective. Default="100".

cpsOverheadTime

Indicates the duration of all other actions on the channel except the talk time and minimum inter-call duration.

cpsInterCallDuration

The minimum time interval between the end of a call on a Voice channel and the start of a new call on the same voice channel.

lpsObjectiveValue

The Loops-per-Second test objective value. Default="100".

lpsType

The mode in which the Loops-per-Second objective is met, either by specifying the talk time or the number of channels, as follows:

Value	Usage
-------	-------



0 (default)	LPS will be met by specifying the talk time. Specify the talk time in <code>lpstalkTime</code> .
1	LPS will be met by specifying the number of channels. Specify the number of channels in <code>lpschannelsNo</code> .

`lpstalkTime`

If `lpstype` is configured 0, this is the estimated talk time value. Default="750".

`lpschannelsNo`

If `lpstype` is configured 1, this is the estimated talk time value. Default="100".

`lpsOverheadTime`

The estimated overhead time. Default="1500".

`lpsInterloopDuration`

The estimated interloop duration. Default="2000".

`lpsActiveChannel`

The referenced test scenario channel.

`activeUsersNo`

The total number of simulated VoIP users (for `ActiveCallers` test objective). Default="100".

`activeUsersObjectValue`

The `ActiveCallers` test objective value. Active callers at any time represent a subset of the total number of users. Default="100".

`activeUserChannel`

The referenced test scenario channel.

`activeUsersTalkTime`

The estimated talk time for the `ActiveCallers` test objective. Default="750".

## EXAMPLE

```
$Activity_Endpoint1 agent.pm.customActivityLinkSettings.config \-lpsActiveChannel
0 \-talkTime 40000 \-lpstalkTime
750 \-interCallDuration 4000 \-callSetupTime
500 \-lpsChannelsNo 100 \-activeUsersNo
100 \-cpsType 0 \-lpsObjectiveValue
100 \-lpsInterLoopDuration 2000 \-cpsOverheadTime
1500 \-activeUsersChannel 0 \-activeUsersObjectiveValue
100 \-cpsInterCallDuration 2000 \-lpsOverheadTime
1500 \-lpstype 0 \-callTeardownTime
```

500	\-bhcaObjectiveValue	80000	\-cpsObjectiveValue
100	\-activeUsersTalkTime	750	\-cpsTalkTime
750	\-bhcaType	0	\-channelsNo
100	\-cpsChannelsNo	100	

**SEE ALSO**

## Simulated Endpoints

Simulated endpoint settings.

### SYNOPSIS

```
$Activity_Endpoint2 agent.pm.endpoints.config \
```

### DESCRIPTION

This object configures the simulated endpoint settings of an Endpoint activity. This object can reside both under an MGCP GW and MGCP CA object.

### SUBCOMMANDS

None.

### OPTIONS

endpointName

The endpoint name.

**Note:** Sequence generator expressions are supported, for example, `aaln[1-3]`.

gwIpAsName

If configured `true`, the `gwName` parameter is specified as an IP address, otherwise it is specified as a fully qualified host name.

gwName

The GW(s) the endpoint is provisioned on.

**Note:** Sequence generator expressions are supported, for example, `gw[001-100].ixialab.com`.

destPhoneSource

Defines the mode in which the destination phone number (for GW) or source phone number (for CA) is specified:

0 = The phone number is specified by the `destPhoneUser` parameter

1 = The phone number is specified by a phone book entry (`destPhonePB` parameter)

2 = The phone number is taken from the CA activity (available for an MGCP GW activity)

destPhonePB

If `destPhoneSource` is configured with a value of 2, this specifies a phone book entry.

destPhoneUser

If `destPhoneSource` is configured with a value of 0, this specifies the call destination phone (for GW) or source phone (for CA).

**Note:** Sequence generator expressions are supported, for example, 170[000000-].

### EXAMPLE

```
$Activity_Endpoint2 agent.pm.endpoints.config \-gwIpAsName
false \-destPhone "170\[000000-\]" \-_labelDestPhone
false \-destPhonePreview "" \-gwName
"gw\[01-10\].ixialab.com" \-endpointName "aaln1" \-
destPhoneType 0 \-destPhoneSource
0 \-destPhonePB "<None>" \-_phoneNoFromCA
false \-destPhoneUser "170\[000000-\]"
```

### SEE ALSO

[MGCP Settings \(GW\)](#)

[MGCP CA Agent](#)

## Data Codecs

VoIP MGCP Endpoint Group Data Codecs

### SYNOPSIS

```
$Activity_Endpoint1 agent.pm.codecSettings.dataCodecs.clear$Activity_Endpoint1
agent.pm.codecSettings.dataCodecs.appendItem \
```

### DESCRIPTION

Data Codecs configures a data codec object, which is added to the `Codec Settings` list of codecs.

### SUBCOMMANDS

None.

### OPTIONS

`id`

Codec type. One of the following:

Codec	Description
Rtp2833Events	Named Events Payload format used for carrying DTMF digits and other line and trunk signals as events.
Rtp2833Tones	RTP Payload format that can represent tones consisting of one or more frequencies.

`dPayloadType`

Payload type used for RTP data packets. Default=(see table) min="96" max="127"

Codec	Default value for dPayloadType
Rtp2833Events	100
Rtp2833Tones	101

### EXAMPLE

```
$Activity_Endpoint1 agent.pm.codecSettings.dataCodecs.clear
```

```
$Activity_Endpoint1 agent.pm.codecSettings.dataCodecs.appendItem \-id
"Rtp2833Events" \-dPayloadType 100
```

**SEE ALSO**

[Codec Settings](#)

## Codecs

VoIP MGCP CA/GW Endpoint audio codecs

### SYNOPSIS

```
$Activity_Endpoint1 agent.pm.codecSettings.codecs.clear$Activity_Endpoint1 agent.p-
m.codecSettings.codecs.appendItem \
```

### DESCRIPTION

Codecs configures an audio codec object, which is added to the `Codec Settings` list of codecs. To add a codec object, use the `appendItem` command.

### SUBCOMMANDS

None.

### OPTIONS

`id`

The codec type, which is one of the following:

Codec	Description
CodecG711u	G.711 mu-law codec
CodecG711a	G.711 A-law codec
CodecG723x153	G.723.1 codec @ 5.3 kbps
CodecG723x163	G.723.1 codec @ 6.3 kbps
CodecG726x16	G.726 codec @ 16 Kbps
CodecG726x24	G.726 codec @ 24 Kbps
CodecG726x32	G.726 codec @ 32 Kbps
CodecG726x40	G.726 codec @ 40 Kbps
CodecG729A	G.729 Annex-A codec
CodeciLBC	iLBC codec

### Options for CodecG711u

`dPayloadIn`

Incoming dynamic payload type. Default="0" min="0" max="127".

dPayloadOut

Outgoing dynamic payload type. Default="0" min="0" max="127".

frameSize

Bytes per frame. Must be one of the following: 40, 80, 160, 240. Default=160.

### **Options for CodecG711a**

dPayloadIn

Incoming dynamic payload type. Default="8" min="0" max="127".

dPayloadOut

Outgoing dynamic payload type. Default="8" min="0" max="127".

frameSize

Bytes per frame. Must be one of the following: 40, 80, 160, 240. Default=160.

### **Options for CodecG723x153**

dPayloadIn

Incoming dynamic payload type. Default="4" min="0" max="127".

dPayloadOut

Outgoing dynamic payload type. Default="4" min="0" max="127".

frameSize

Bytes per frame. Must be one of the following: 20. Default=20.

### **Options for CodecG723x163**

dPayloadIn

Incoming dynamic payload type. Default="4" min="0" max="127".

dPayloadOut

Outgoing dynamic payload type. Default="4" min="0" max="127".

frameSize

Bytes per frame. Must be one of the following: 24. Default=24.

### **Options for CodecG723x163**

dPayloadIn



Incoming dynamic payload type. Default="4" min="0" max="127".

dPayloadOut

Outgoing dynamic payload type. Default="4" min="0" max="127".

frameSize

Bytes per frame. Must be one of the following: 24. Default=24.

### Options for CodecG726x16

dPayloadIn

Incoming dynamic payload type. Default="102" min="0" max="127".

dPayloadOut

Outgoing dynamic payload type. Default="102" min="0" max="127".

byteOrder

Byte order.

Option	Description
0 (default)	Big Endian
1	Little Endian

frameSize

Bytes per frame. Must be one of the following: 20, 40, 60. Default=20.

### Options for CodecG726x24

dPayloadIn

Incoming dynamic payload type. Default="103" min="0" max="127".

dPayloadOut

Outgoing dynamic payload type. Default="103" min="0" max="127".

byteOrder

Byte order.

Option	Description
0 (default)	Big Endian
1	Little Endian

frameSize

Bytes per frame. Must be one of the following: 30, 60, 90. Default=30.

### Options for CodecG726x32

dPayloadIn

Incoming dynamic payload type. Default="104" min="0" max="127".

dPayloadOut

Outgoing dynamic payload type. Default="104" min="0" max="127".

byteOrder

Byte order.

Option	Description
0 (default)	Big Endian
1	Little Endian

frameSize

Bytes per frame. Must be one of the following: 40, 80, 120. Default=40.

### Options for CodecG729

dPayloadIn

Incoming dynamic payload type. Default="18" min="0" max="127".

dPayloadOut

Outgoing dynamic payload type. Default="18" min="0" max="127".

cbxFrameSize

Bytes per frame. Must be one of the following: 10, 20, 30, 40, 50, Custom. Default=10.

customFrameSize

If `cbxFrameSize` is `Custom`, this option configures the custom frame size. Default="120" min="10" max="200".

### EXAMPLE

```
$Activity_Endpoint1 agent.pm.codecSettings.codecs.clear$Activity_Endpoint1 agent.p-  
m.codecSettings.codecs.appendItem \-id  
"CodecG711u" \-dPayloadOut 0 \-dPayloadIn  
0 \-frameSize 160
```

**SEE ALSO**

[Codec Settings](#)

## SDP Settings

### VoIP MGCP Endpoint SDP Settings

#### SYNOPSIS

```
$Activity_Endpoint1 agent.pm.sdpSettings.config \
```

#### DESCRIPTION

MGCP uses SDP for specification and negotiation of media capabilities of GW endpoints. SDP information is sent using a stream descriptor that specifies a single bi-directional media stream.

#### SUBCOMMANDS

None.

#### OPTIONS

```
useCustomSdp
```

If `true`, the auto SDP template constructed from the codec list can be overridden by editing the SDP template. Default=`false`.

```
customSPDP
```

The SDP string that is used when the Auto option is selected for an SDP descriptor.

#### EXAMPLE

```
$Activity_Endpoint1 agent.pm.sdpSettings.config \-useCustomSDP
false \-customSDP "v=0 \o=- 0 0 IN IP4 <\$VOIP_Sig-
nalingIP> \s=session \c=IN IP4 <\$VOIP_MediaIP> \t=0 0 \m=audio <\$VOIP_Medi-
aBasePort> RTP/AVP 0 8 100 101 \a=rtpmap:0 PCMU/8000 \a=rtpmap:8 PCMA/8000
\a=rtpmap:100 telephone-event/8000 \a=rtpmap:101 tone/8000 \a=ptime:20"
```

#### SEE ALSO

[VoIP MGCPGW Agent](#)

## RTP Settings

VoIP MGCP Endpoint RTP settings

### SYNOPSIS

```
$Activity_Endpoint1 agent.pm.rtpSettings.config \
```

### DESCRIPTION

The RTP Settings configure the VoIP MGCP MGC/GW Endpoint group RTP settings.

### SUBCOMMANDS

None.

### OPTIONS

enableRTP

If true, enables use of RTP to transport the media traffic. Default= false.

enableRTCP

If true, enables use of RTCP for RTP traffic. Default= false.

rtpPort

The port used for audio/video RTP streaming. Default="10000".

chEnableHwAcc

If true, enables hardware acceleration for RTP traffic. Default=false.

enableAdvStatCalc

If true, enables the computation of advanced audio RTP statistics.

enableMDI

Enables computation of MDI DF and MDI MLR statistics.

enableNBExec

If true, all RTP functions from a scenario execute in a non-blocking mode, i.e the current function from a channel executes in the background, allowing the execution to continue on that channel with the next script function. Default= False.

### EXAMPLE

```
$Activity_Endpoint1 agent.pm.rtpSettings.config \-enableRTP
false \-enableRTCP                               false \-chEnableHwAcc
true \-chDisableHwAcc                             false \-enableAdvStatCalc
false \-enablePerStream                           false \
-enableMDI false \
-rtpPort                                           "[10000-65535,4]" \-enableNBExec
```

false

**SEE ALSO**

[VoIP MGCPGW Agent](#)

## Audio Settings

VoIP MGCP MGC/GW Endpoint audio settings

### SYNOPSIS

```
$Activity_Endpoint1 agent.pm.audioSettings.config \
```

### DESCRIPTION

The Audio Settings configure the VoIP MGCP MGC/GW Endpoint audio RTP settings.

### SUBCOMMANDS

None.

### OPTIONS

```
enableAudio
```

If selected, audio script functions are executed, otherwise they are skipped.

```
audioClip
```

The played audio clip file.

```
playTypeAudio
```

The mode in which the clip is played.

Value	Usage
0 (default)	The clip is played for clip duration or for the duration of the Talk Time parameter in the case of BHCA/CPS/LPS objectives.
1	The clip is played for a user-defined duration.

```
audioDurationUnit
```

The play duration unit, which can be milliseconds (0), seconds (1), minutes (2), or hours (3).

```
outputLevel
```

The output level of the played clip.

```
enableTosRtp
```

Enables use of TOS/DSCP. Use the `rtpTos` option to specify the TOS/DSCP value. Default= False

```
rtpTosVal
```

The Type of Service (TOS/DSCP) byte setting in the sent RTP packets has one of the following values:

- Best Effort (0x00): Routine service

- Class 1 (0x20): Priority service, Assured Forwarding class 1
- Class 2 (0x40): Immediate service, Assured Forwarding class 2
- Class 3 (0x60): Flash, Assured Forwarding class 3
- Class 4 (0x80): Flash-override, Assured Forwarding class 4
- Express Forwarding (0xA0): Critical-ecp
- Control (0xC0): Internet-control
- Custom: A user-specified value.

useMOS

Enables the computation of MOS scores. Default= False.

enableAudioOWD

If true, IxLoad computes the One-way Delay metric, a network measurement specifying the amount of time (in ms) that a packet has spent on the network before it was received on the destination side. Default= False

useJitter

If true, enables use of a jitter buffer. Default= False.

jjitMs

If useJitter is 1, this option configures the size of the jitter buffer, in milliseconds. Default="20" min="1" max="3000".

useJitComp

If true, enables dynamic modification of the jitter buffer size. Default= False.

jitCms

If useJitComp is 1, this option configures the maximum size in of the jitter buffer, in milliseconds. Default="1000" min="0" max="3000".

jitCMaxDrop

If useJitComp is 1, this option configures the condition - a maximum number of consecutive packets dropped - that determines the jitter buffer size to be increased.

enableQoV

If true, this enables QoV P.862 PESQ and P.56 QoV computation. Default= False.

channelTypeQoV

When enableQoV is true, this specifies the objective type as either of the following:

- Number of channels (0)
- Percentage (1)

valueQoV



When `enableQoV` is `true`, this specifies the number of channels for which PESQ and P.56 QoV metrics are computed (when `channelTypeQoV` is 0). Alternatively this represents the percentage of channels for which PESQ and P.56 QoV metrics are computed (when `channelTypeQoV` is 1).

`unitsQoV`

The channels selection mode, which can be any of the following:

- First channels (0)
- Last channels (1)
- Evenly-spaced channels (2)
- Random (3)

`metricsQoV`

When `enableQoV` is `true`, this specifies the metric that is calculated by the Zion card. Available options are:

- PESQ and P.56 (0)
- PESQ (1)
- P56 (2)

`useSilence`

If `true`, RTP packets containing artificial background noise are sent when no other media (DTMF, MF, real payload, and so on) is sent over the communication channel. `Default= False`.

`silenceMode`

If `useSilence` is 1, this option configures the silence mode.

Value	Usage
0	Null data encoded
1 (default)	Comfort noise.

## EXAMPLE

```
$Activity_Endpoint1 agent.pm.audioSettings.config \-enableAudio
true \-audioClip "US_042.wav" \-playTypeAudio
0 \-audioDurationUnit 1 \-audioDuration
10 \-outputLevel -20 \-enableAudioOWD
false \-enableTosRtp false \-rtpTosVal
32 \-useMos false \-useJitter
false \-jitMs 20 \-useJitComp
false \-jitCMs 1000 \-jitCMaxDrop
7 \-enableQoV false \-channelTypeQoV
0 \-valueQoV 100 \-unitsQoV
```

```
0 \-metricsQoV  
false \-silenceMode
```

```
0 \-useSilence  
1 \
```

**SEE ALSO**

[VoIP MGCPGW Agent](#)

## Other Settings

VoIPMGCP MGC/GW EndpointGroup Other Settings

### SYNOPSIS

```
$Activity_Endpoint1 agent.pm.otherSettings.config \
```

### DESCRIPTION

This object configures the VoIP MGCP MGC/GW Endpoint Group activity's miscellaneous options.

### SUBCOMMANDS

None.

### OPTIONS

VOIP\_Var0

The VOIP\_Var1...VOIP\_Var5 and VOIP\_IPAddr1...VOIP\_IPAddr5 string-type variables supporting generator expressions enable you to generate 10 series of global variables whose values are used at runtime by the simulated MGCP Endpoint Group phones/channels. `Default=""`.

Use the VOIP\_Var1...VOIP\_Var5 variables to represent phone numbers, and the VOIP\_IPAddr1...VOIP\_IPAddr5 to represent IP addresses.

VOIP\_Var1

See VOIP\_Var0.

VOIP\_Var2

See VOIP\_Var0.

VOIP\_Var3

See VOIP\_Var0.

VOIP\_Var4

See VOIP\_Var0.

VOIP\_IPAddress0

See VOIP\_Var0.

VOIP\_IPAddress1

See VOIP\_Var0.

VOIP\_IPAddress2

See VOIP\_Var0.

VOIP\_IPAddress3

See VOIP\_Var0.

VOIP\_IPAddress4

See VOIP\_Var0.

**EXAMPLE**

```
$Activity_Endpoint1 agent.pm.otherSettings.config \-VOIP_Var1
"" \-VOIP_Var0                               "" \-VOIP_Var3
"" \-VOIP_Var2                               "" \-VOIP_Var4
"" \-VOIP_IPAddress4                         "" \-VOIP_IPAddress1
"" \-VOIP_IPAddress0                         "" \-VOIP_IPAddress3
"" \-VOIP_IPAddress2                         ""
```

**SEE ALSO**

[VoIP MGCPGW Agent](#)

## VoIP SIP Cloud

The IxLoad VoIP SIP Cloud Peer Tcl API consists of a VoIP SIP Cloud Peer agent, with separate APIs for configuring each major aspect of the agent's functionality.

## Limitations

The following restrictions and limitations of the VoIP SIP Cloud Peer API exist:

- A VoIPSIP Cloud Peer activity and the VoIPSIP Peer activity it is associated to must reside on the same NetTraffic.
- A network range assigned to a VoIPSIP Cloud necessarily has to be of the Round-Robin IP distribution type.

## VoIP SIP Cloud API Commands

The IxLoad VoIP SIP Cloud API commands are organized as shown in the figure below.

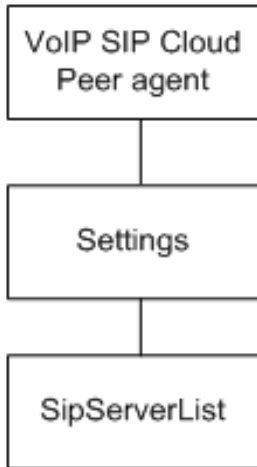

## API Objects

The following table lists the VoIP SIP Cloud Peer API objects

Object	Description
VoIP SIPCloud Peer Agent	Top-level object defining the VoIP SIP Cloud Peer activity.
Settings	VoIPSIP Cloud IP addressing type settings.
SipServerList	List of SIP Proxy servers emulated by the activity.

## VoIPSIP Cloud Agent

VoIPSIPCloud Peer Agent

### SYNOPSIS

```
set Activity_VoIPSIPPeer1 [$Traffic1_Network1 activityList.appendItem \  
-protocolAndType          "VoIPSIPCloud Peer" ]
```

### DESCRIPTION

A VoIPSIPCloud Peer agent is added to the `agentList` option of the `ixConfig` object using the `appendItem` subcommand from the `ixConfigSequenceContainer` command, as shown in the following example:

```
set Activity_VoIPSipCloud1 [$Traffic1_Network1 activityList.appendItem \  
protocolAndType          "VoIPSipCloud Peer" ]  
  
$Activity_VoIPSipCloud1 config \-enable          true \-name  
"VoIPSipCloud1"  
  
$Activity_VoIPSipCloud1 agent.config \-enable          true  
\-name          "VoIPSipCloud1"
```

Each member of the list may be separately addressed and modified using the `ixConfig` subcommands. For example, the first agent uses an index of 0 and its name may be modified by using the following command:

```
$Activity_VoIPSipCloud1 agent(0).config -name "VoIPSIP Cloud Peer2"
```

### SUBCOMMANDS

None.

### OPTIONS

`enable`

Enables the use of this agent. (Default = true).

`name`

The name associated with this object, which must be set at object creation time.



## STATISTICS

The following table lists the statistics published by this object.

Statistic	Description	Per Channel/Global
Dispatched messages	This statistic is incremented when a received message has been parsed and a matching dispatching rule was found for it.	Global
Undispatched messages	This statistic is incremented when a received message has been parsed and a matching dispatching rule was not found for it.	Global
Sent Messages	This statistics is incremented when an message was sent from a server in the cloud.	Global
Parsed Messages	This statistic is incremented when a message was successfully parsed.	Global
Parser errors	This statistic is incremented on the cloud in the data process function, after parsing the received stream, if we receive parser errors when we try to process the stream.	Global
Bytes Transmitted	This statistic is incremented only on the cloud for sent messages. Messages sent by a SIP peer through the cloud will not be accounted to the SIP peer's bytes sent.	Global
Bytes Received	This statistic is incremented only on the cloud for received messages. Messages received by a SIP peer through the cloud will not be accounted to the SIP peer's bytes received.	Global

### EXAMPLE

```
set Activity_VoIPSipCloud1 [${Traffic1_Network1 activityList.appendItem \-
protocolAndType                "VoIPSipCloud Peer" ]

$Activity_VoIPSipCloud1 config \-enable                true \-name
"VoIPSipCloud1"

$Activity_VoIPSipCloud1 agent.config \-enable                true
\ -name                "VoIPSipCloud1"
```

### SEE ALSO

ixConfig

## Settings

VoIPSIPCloud Peer Settings

### SYNOPSIS

```
$Activity_VoIPSipCloud1 agent.pm.settings.config \  
-ipPreference          0  
$Activity_VoIPSipCloud1 agent.pm.settings.sipServerList.clear
```

### DESCRIPTION

Contains the preferred IP addressing type used, IPv4- or IPv6-only.

### SUBCOMMANDS

None.

### OPTIONS

ipPreference

The preferred IP address type:

0 = Only IPv4 (default)

1 = Only IPv6

### EXAMPLE

```
$Activity_VoIPSipCloud1 agent.pm.settings.config \-ipPreference  
0
```

### SEE ALSO

## SIP Server List

SIP Proxy Servers List

### SYNOPSIS

```
$Activity_VoIPSipCloud1 agent.pm.settings.sipServerList.appendItem \  
-optionvalue
```

### DESCRIPTION

A `SipServerList` contains the list of SIP Proxy Servers emulated by the VoIPSIP Cloud Peer. To add `SipServer` objects, use the `appendItem` subcommand from the `ixConfigSequenceContainer` command.

**Note:** The `SipServerList` class has to be configured alongside the `CloudServers` class of a VoIP SIP Peer that implements the same functionality.

### SUBCOMMANDS

None.

### OPTIONS

`id`

The SIP server list ID.

`firstIp`

The first IP address in the network range associated with the SIP Proxy server. This is the SIP Proxy server that is located at the cloud boundary.

`name`

The server name (default `sip_server#1` and subsequent strings).

`rangeType`

The range type, which can be only IP for VoIP SIP Cloud peers.

`ipAddr`

The start IP address of the associated network range.

`netMask`

The network mask.

`ipStep`

The incrementation step of the start IP address (default "0.0.0.1").

attachedInfo

An extra string associated with the proxy, such as for example a domain name (default = sip-test.my-domain.com).

ipCount

The number of hosts (default = 1).

port

The SIP port (default = 5060).

ipType

The IP addressing type, IPv4 or or IPv6.

### EXAMPLE

```
$Activity_VoIPSipCloud1 agent.pm.settings.sipServerList.appendItem \  
-id"SipServer" \  
-firstIp"172.20.13.1" \  
-name"sip_server#1" \  
-rangeType"IP" \  
-ipAddr"Network Range 2 in Network1 (172.20.13.1+1)" \  
-ipStep"0.0.0.1" \  
-attachedInfo"sip-test.my-domain.com" \  
-netMask"255.254.0.0" \  
-ipCount"1" \  
-port5060 \  
-ipType"IPv4"
```

### SEE ALSO

! 40

## VoIP SIP Peer

The IxLoad VoIP SIP Peer Tcl API consists of a VoIP SIP Peer agent, with separate APIs for configuring each major aspect of the agent's functionality.

**Note:** IxLoad supports two different approaches for SIP protocol testing:

- Basic SIP protocol testing support, the simpler of the two supported approaches for SIP testing, is based on SIP Client and SIP Server activities having only limited call flow configuration capabilities.  
The Tcl API configuration commands corresponding to this approach are covered in `SIP Protocol Support`.
- Advanced SIP testing support is based on VoIPSIPPeer activities capable of executing more complex, custom protocol message flows.  
The Tcl API configuration commands for this approach are covered in this chapter.

## Limitations

The following restrictions and limitations of the VoIP SIP Peer API exist:

- The PhoneBook and other related classes, such as PhoneBookEntry, cannot be edited from the Tcl API.
- Individual VoIP SIP script functions cannot be added and edited from the Tcl API. Instead, you must add and configure the commands in the Scenario Editor, save the test scenario file, then pass it as an argument to the `Scenario Settings` API class.
- Implementation of the BHCA and CPS objective features relies on two classes, `CustomParameters` and `CustomActivityLinkSettings` that have to be configured using the same parameters.

## VoIP SIP Peer API Commands

The IxLoad VoIP SIP Peer API commands are organized as shown in the figure below.

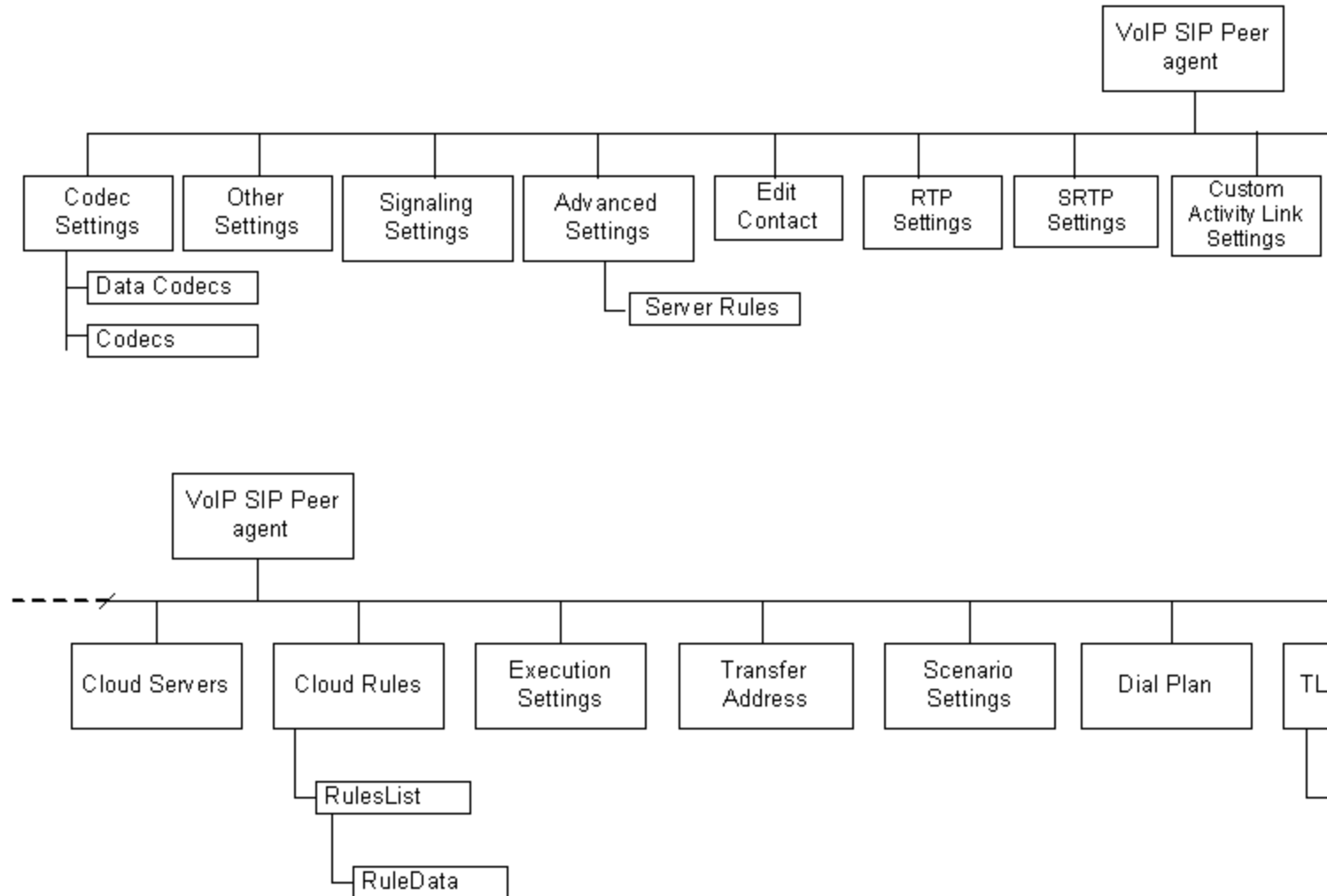

## VoIP SIP Peer API Objects

The table below summarizes the objects in the VoIP SIP Peer API.

Object	Description
VoIP SIP Peer Agent	Top-level object defining the VoIP SIP Peer activity.
Codec Settings	List of <code>Data Codecs</code> and <code>Codecs</code> objects.
Data Codecs	Data codec with parameters.
Codecs	Audio codec with parameters.
Other Settings	VoIP SIP Peer miscellaneous parameters; corresponds to the Other Settings tab in GUI.
Signaling Settings	VoIP SIP Peer parameters corresponding to the SIP Settings GUI tab.
Edit Contact	Replacement contact information; corresponds to Override Contact control on the Contact Settings tab in GUI.
RTP Settings	RTP transport configuration; corresponds to the RTP Settings GUI tab.
Audio Settings	Audio settings; corresponds to the Audio GUI tab.
T.38 Settings	T.38 IP fax settings; corresponds to the T.38 GUI tab.
T.30 Settings	T.30 settings; corresponds to the T.30 GUI tab.
SRTP Settings	SRTP configuration corresponding to the SRTP Settings GUI tab.
MSRP Settings	MSRP configuration that corresponds to the MSRP GUI tab.
MSRP GUI files	The configuration of files sent over an established MSRP session.
MSRP Relays	The configuration of MSRP relays an endpoint authenticates against.
Custom Activity Link Settings	BHCA and CPS objective configuration; corresponds to the Custom Parameters GUI tab.
Execution Settings	Run-time test configuration; corresponds to the Execution Settings GUI tab.
Transfer Address	Configures a SIP transfer address. corresponds to the Transfer Address window opened from the SIP Settings GUI tab.
Scenario Settings	Selects the Test Scenario file; corresponds to the Scenario Settings GUI tab.

Dial Plan	Configures the source, destination, and transfer addresses and phone numbers for the channels/endpoints; corresponds to the Dial Plan GUI tab.
Timer Settings	Configures session refresh and SIP message retransmission settings; corresponds to the Automatic GUI tab.
TLS Settings	TLS transport configuration corresponding to the TLS GUI tab.
TlsCyphers	Configures a list of cyphers supported by the VoIPSipPeer activity.
CustomParameters	BHCA and CPS objective configuration; corresponds to the Custom Parameters GUI tab.
Advanced Settings	Configures a VoIPSIP Cloud Peer activity associated with the VoIPSIP Peer. Corresponds to the SIP Cloud Settings GUI tab.
CloudServers	Configures the list of SIP Proxy servers emulated by a VoIPSIP Cloud Peer.
ServerRules	Configures a list of rules associated with each emulated SIP Proxy server in the cloud.
CloudRules	Configures a list of dispatching rules that override the default VoIP SIP Cloud rules.
RuleData	Configures the processing operations applied to incoming SIP messages for extracting an overriding dispatching rule. Corresponds to the Edit Cloud Rule GUI.



## VoIP SIP Peer Agent

VoIP SIP Peer Agent

### SYNOPSIS

```
set Activity_VoIPSIPPeer1 [$SIP_Network1 activityList.appendItem \-protocolAndType
"VoIPSIP Peer" ]
```

### DESCRIPTION

A VoIP SIP Peer agent is added to the `agentList` option of the `ixConfig` object using the `appendItem` subcommand from the `ixConfigSequenceContainer` command. Other `ixConfigSequenceContainer` subcommands may be used to modify the `agentList`. See the following example:

```
set Activity_VoIPSIPPeer1 [$SIP_Network1 activityList.appendItem \-protocolAndType
"VoIPSIP Peer" ]
```

```
$Activity_VoIPSIPPeer1 config \-enable true \-name
"VoIPSIPPeer1" \-enableConstraint false \-userObjectiveValue
1 \-constraintValue 100 \-userObjectiveType
"channels" \-timeline $Timeline1
```

```
$Activity_VoIPSIPPeer1 agent.config \-enable true
\-name "VoIPSIPPeer1"
```

Each member of the list, however may be separately addressed and modified using the `ixConfig` subcommands. For example, the first agent uses an index of 0 and its name may be modified by:

```
$Activity_VoIPSIPPeer1 agent(0).config -name "VoIPSIP Peer new"
```

### SUBCOMMANDS

None

### OPTIONS

`enable`

Enables the use of this agent. (Default = true).

`name`

The name associated with this object, which must be set at object creation time.

### STATISTICS

The statistics published by this agent are listed below.

Statistic	Description	Per Channel/Global
<b>VoIPSIP Channels</b>		
Successful Channels	The instantaneous number of COMPLETED channels. A channel is COMPLETED if all the channel loops were COMPLETED.	Global
Warning Channels	The instantaneous number of WARNING channels. A channel is WARNING if all the channel loops were COMPLETED or WARNING and at least one loop had a WARNING result.	Global
Failed Channels	The instantaneous number of FAILED channels. A channel is FAILED if all the channel loops were COMPLETED or WARNING, and at least one loop was FAILED.	Global
Aborted Channels	The instantaneous number of ABORTED channels. A channel is ABORTED if all the channel loops were COMPLETED, WARNING, FAILED, or ABORTED and at least one loop was ABORTED.	Global
Active Channels	The instantaneous number of active channels. Active channels are the channels executing a scenario channel functions flow.	Global
Total Channels	The instantaneous total number of channels, a sum of active and non-active channels.	Global
<b>VoIPSIP Loops</b>		
Successful Channel Loops	The cumulative count of COMPLETED channel loops. A channel loop is COMPLETED if all executed script functions in the corresponding scenario channel produced SKIPPED or COMPLETED results.	Global
Warning Channel Loops	The cumulative count of WARNING channel loops. A channel loop has a WARNING result if all executed script functions in the corresponding scenario channel produced SKIPPED, COMPLETED, or WARNING results and at least one script function had a WARNING result.	Global

Failed Channel Loops	The cumulative count of FAILED channel loops. A channel loop is FAILED if all executed script functions in the corresponding scenario channel produced SKIPPED, COMPLETED, WARNING, or FAILED results and at least one script function had a FAILED result.	Global
Aborted Channel Loops	The cumulative count of ABORTED channel loops. A channel loop is FAILED if all the executed script functions in the corresponding scenario channel produced SKIPPED, COMPLETED, WARNING, FAILED, or ABORTED results and at least one script function had an ABORTED result.	Global
Total Channel Loops	The cumulative count of executed loops.	Global
Interloop Duration (Avg) [ms]	The time gap between loops.	Global
<b>VoIPSIP Loop Rate</b>		
Loops-per-second	The instantaneous loops-per-second value, taking into account started loops.	Global
<b>VoIPSIP Calls</b>		
Attempted Calls	The cumulative count of initiated calls. This statistic is incremented when an INVITE for a new dialog is sent.	Global
Connected Calls	The cumulative count of established calls. This statistic is incremented when a 200 OK response is received and the SDP negotiation is successful for the call.	Global
Received Calls	The cumulative count of received incoming calls. This statistic is incremented when an INVITE for a new dialog is parsed and matched.	Global
Answered Calls	The cumulative count of answered incoming calls. This statistic is incremented when a 200 OK message is sent and the SDP negotiation is successful for the call.	Global
Rejected Calls	The cumulative count of rejected incoming calls.	Global

Failed Calls	<p>The cumulative count of failed calls.</p> <p>This statistic is calculated at the end of the script loop as (Attempted Calls - Connected Calls) on originating endpoints and as (Received Calls - Answered Calls) on receiving endpoints.</p> <p><b>NOTE:</b> This statistic deals only with failed originated/received calls - problems with the initiation part of the call and not with the successful conclusion of the call.</p>	Global
Transferred Calls	The cumulative count of originated or incoming calls that were transferred.	Global
Busy Calls	The cumulative count of originated or incoming calls that were rejected with busy cause.	Global
Redirected Calls	The cumulative count of originated or incoming calls that were redirected.	Global
Calls with Authentication Required	The cumulative count of originated or incoming calls that required use of authentication.	Global
Calls Over UDP	The cumulative count of completed originated or incoming calls using UDP transport.	Global
Calls Over TCP	The cumulative count of completed originated or incoming calls using TCP transport.	Global
Calls Over TLS	The cumulative count of completed originated or incoming calls using TLS transport.	Global
Calls Over Mixed Transport	The cumulative count of completed originated or incoming calls using mixed UDP/TCP transport.	Global
Active Calls	<p>The cumulative count of active calls at one time.</p> <p>For the initiator side a call is active after having sent an ACK message and until receiving or sending a 200 OK for BYE message, depending on who is disconnecting the session.</p> <p>For the terminating side, a call is active after having sent an 200 OK for INVITE message (with SDP negotiation having completed successfully) and until sending or receiving a 200 OK for BYE message, depending on the party disconnecting the session.</p>	Global

End Calls Initiated	The cumulative count of initiated end call procedures, incremented whenever a SIP BYE message is sent.	Global
End Calls Received	The cumulative count of received end call procedures, incremented whenever a SIP BYE message is received.	Global
End Calls Completed	The cumulative count of completed end call procedures.	Global
<b>VoIPSIP Call Rates</b>		
Attempted calls/s, Connected Calls/s, Received Calls/s, Answered Calls/s, Rejected Calls/s, Transferred Calls/s, Busy Calls/s, Redirected Calls/s, Calls with Authentication Required/s, Calls Over UDP /s, Calls Over TCP /s, Calls Over TLS /s,	The rates for the above <i>VoIPSIP Call</i> statistics.	Global
<b>VoIPSIP Call Times</b>		
Call Setup Time (Avg) [ms]	The average duration between the moment a call is initiated (e.g. a SIP INVITE request message is sent/received) and the moment the call is connected (e.g. SIP ACK for INVITE is sent/received).	Global
Talk Time (Avg) [ms]	The average talk time (the duration between the moment the call is connected and the moment the call is disconnected by one of the parties).	Global

Call End Time (Avg) [ms]	The average duration between the moment a call disconnect is initiated (e.g. a SIP BYE request message is sent) and the moment the call is cleared (e.g. a 200 OK response is received)	Global
Total Call Duration (Avg) [ms]	The average call duration. When referring to a single call: (Entire) Call Length = Call Setup-Time + Talk Time + Call Teardown Time.	Global
<b>VoIPSIP Session Refreshes</b>		
Attempted Session Refreshes	The cumulative count of attempted session refreshes (re-registrations, re-invites, updates treated as refreshes).	
Received Session Refreshes	The cumulative count of received session refreshes (re-invites, updates treated as refreshes).	
Successful Session Refreshes	The cumulative count of successful session refreshes (ACK received for INVITE refresh, 200 Ok to UPDATE sent, or 200 Ok received for REGISTER)	
Failed Session Refreshes	The cumulative count of failed session refreshes (non 2xx responses and transaction failures).	
<b>VoIPSIP SSL Handshake</b>		
Client Hello Sent	The cumulative count of Client Hello messages sent.	Global
Client Hello Received	The cumulative count of Client Hello messages received.	Global
Server Hello Sent	The cumulative count of Server Hello messages sent.	Global
Server Hello Received	The cumulative count of Server Hello messages received.	Global
SSL Negotiations Finished Successfully	The cumulative count of SSL sessions negotiations finished successfully.	Global
SSL Errors Sent	The cumulative count of errors sent.	Global
SSL Errors Received	The cumulative count of errors received.	Global
SSL Alerts Sent	The cumulative count of SSL alerts of all types sent.	Global
SSL Alerts Received	The cumulative count of SSL alerts of all types received.	Global

<b>VoIPSIP SSL Throughput</b>		
SSL Throughput (Mbps)	The combined rate at which the peer sends and receives SSL data.	Global
SSL Tx Rate (Mbps), SSL Rx Rate (Mbps)	The total bytes sent/received over the SSL connection, including control and data bytes.	Global
<b>VoIPSIP SSL Warning Alerts</b>		
SSL Alerts Sent (user_canceled)	The cumulative count of <i>User Canceled</i> alerts sent.	Global
SSL Alerts Sent (unsupported_certificate)	The cumulative count of <i>Unsupported Certificate</i> alerts sent.	Global
SSL Alerts Sent (record_overflow)	The cumulative count of <i>Record Overflow</i> alerts sent.	Global
SSL Alerts Sent (no_renegotiation)	The cumulative count of <i>No Renegotiation</i> alerts sent.	Global
SSL Alerts Sent (no_certificate)	The cumulative count of <i>No Certificate</i> alerts sent.	Global
<b>VoIPSIP SSL Fatal Alerts</b>		
SSL Alerts Sent (unknown_ca)	The cumulative count of <i>Unknown CA</i> alerts sent.	Global
SSL Alerts Sent (unexpected_message)	The cumulative count of <i>Unexpected Message</i> alerts sent.	Global
SSL Alerts Sent (protocol_version)	The cumulative count of <i>Protocol Version</i> messages sent.	Global
SSL Alerts Sent (internal_error)	The cumulative count of <i>Internal Error</i> messages sent.	Global
SSL Alerts Sent (insufficient_security)	The cumulative count of <i>Insufficient Security</i> alerts sent.	Global
SSL Alerts Sent (illegal_parameter)	The cumulative count of <i>Illegal Parameter</i> alerts sent.	Global

SSL Alerts Sent (handshake_failure)	The cumulative count of <i>Handshake Failure</i> alerts sent.	Global
SSL Alerts Sent (export_restriction)	The cumulative count of <i>Export Restriction</i> alerts sent.	Global
SSL Alerts Sent (decompression_failure)	The cumulative count of <i>Decompression Failure</i> alerts sent.	Global
SSL Alerts Sent (decode_error)	The cumulative count of <i>Decode Error</i> alerts sent.	Global
SSL Alerts Sent (bad_record_mac)	The cumulative count of <i>Bad MAC Record</i> alerts sent.	Global
SSL Alerts Sent (access_denied)	The cumulative count of <i>Access Denied</i> alerts sent.	Global
SSL Alerts Received (unknown_ca)	The cumulative count of <i>Unknown CA</i> alerts received. An <i>Unknown CA</i> alert is sent if a valid certificate chain or partial chain was received, but the certificate was not accepted because the CA certificate could not be located or could not be matched with a known, trusted CA.	Global
SSL Alerts Received (unexpected_message)	The cumulative count of <i>Unexpected Message</i> alerts received. An <i>Unexpected Message</i> alert is sent when an SSL peer receives a message that it was not expecting, for example if it received handshake data when it was expecting application data.	Global
SSL Alerts Received (protocol_version)	The cumulative count of <i>Protocol Version</i> alerts received. A <i>Protocol Version</i> alert is sent if the protocol version the client has attempted to negotiate is recognized, but not supported. (For example, old protocol versions might be avoided for security reasons).	Global
SSL Alerts Received (internal_error)	The cumulative count of <i>Internal Error</i> alerts received. An <i>Internal Error</i> alert is sent if an internal error unrelated to the peer or the correctness of the protocol makes it impossible to continue, such as a memory allocation failure.	Global



SSL Alerts Received (insufficient_security)	The cumulative count of <i>Insufficient Security</i> messages received. An <i>Insufficient Security</i> alert is returned instead of a <i>Handshake Failure</i> when a negotiation has failed specifically because the peer requires ciphers more secure than those supported by the client.	Global
SSL Alerts Received (illegal_parameter)	The cumulative count of <i>Illegal Parameter</i> alerts received. An <i>Illegal Parameter</i> alert is sent if a field in the handshake was out of range or inconsistent with other fields.	Global
SSL Alerts Received (handshake_failure)	The cumulative count of <i>Handshake Failure</i> alerts received. The reception of a <i>Handshake Failure</i> alert message indicates that the sender was unable to negotiate an acceptable set of security parameters from the options available.	Global
SSL Alerts Received (decompression_failure)	The cumulative count of <i>Decompression Failure</i> alerts received. A <i>Decompression Failure</i> alert is sent when the decompression function received improper input (data that expanded to an excessive length).	Global
SSL Alerts Received (decode_error)	The cumulative count of <i>Decode Error</i> alerts received. A <i>Decode Error</i> alert is sent when a message could not be decoded because a field was out of the specified range or the length of the message was incorrect.	Global
SSL Alerts Received (bad_record_mac)	The cumulative count of <i>Bad MAC Record</i> alerts received. A <i>Bad MAC Record</i> alert is sent when a message is received with an incorrect MAC (Message Authentication Code).	Global
SSL Alerts Received (access_denied)	The cumulative count of <i>Access Denied</i> alerts received. An <i>Access Denied</i> alert is sent if a valid certificate was received, but when access control was applied, the sender decided not to proceed with negotiation.	Global

SSL Alerts Received (export_restriction)	The cumulative count of <i>Export Restriction</i> alerts received. An <i>Export Restriction</i> alert is sent when a negotiation not in compliance with export restrictions was detected; for example, attempting to transfer a 1024 bit ephemeral RSA key for the RSA_EXPORT handshake method.	Global
<b>VoIPSIP SSLv2 Errors</b>		
SSL Errors Sent (unsupported certificate)	The cumulative count of <i>Unsupported Certificate</i> error messages sent.	Global
SSL Errors Sent (undefined error)	The cumulative count of <i>Undefined Error</i> messages sent.	Global
SSL Errors Sent (no cipher)	The cumulative count of <i>No Cipher</i> messages sent.	Global
SSL Errors Sent (bad certificate)	The cumulative count of <i>Bad Certificate</i> error messages. sent.	Global
SSL Errors Received (unsupported certificate)	The cumulative count of <i>Unsupported Certificate</i> error messages received. This error is returned when a peer receives a certificate type that it does not support. An <i>Unsupported Certificate</i> error is recoverable for client authentication only.	Global
SSL Errors Received (undefined error)	The cumulative count of <i>Undefined Error</i> messages received. An <i>Undefined Error</i> is returned by the client to the peer when it cannot find a supported cipher or key size that is also supported by the peer. An <i>Undefined Error</i> is not recoverable.	Global
SSL Errors Received (no cipher)	The cumulative count of <i>No Cipher</i> messages received. A <i>No Cipher</i> error is returned by the client to the peer when it cannot find a cipher or key size that it supports that is also supported by the peer. A <i>No Cipher</i> error is not recoverable.	Global
SSL Errors Received (no certificate)	The cumulative count of <i>No Certificate</i> error messages received. When a REQUEST-CERTIFICATE message is sent, this error may be returned if the client has no certificate to reply with. A <i>No Certificate</i> error is recoverable for client authentication only.	Global

SSL Errors Received (bad certificate)	The cumulative count of <i>Bad Certificate</i> error messages received. A <i>Bad Certificate</i> error is returned when a certificate is deemed `bad' by the receiving party, either because the signature of the certificate was bad, or the values in the certificate were inappropriate (for example, a name in the certificate did not match the expected name).  A <i>Bad Certificate</i> error is recoverable for client authentication only.	Global
<b>VoIPSIP Delays</b>		
Post Dial Delay (Avg) [ms]	The per polling interval time elapsed between sending an INVITE message and receiving an answer from the peer endpoint. This statistic is relevant for the call originating endpoint.	Global
Media Delay TX (Avg) [ms], Media Delay TX (Max) [ms], Media Delay TX (Min) [ms]	The per polling interval average/min/max media delay computed as the time elapsed between the sending of the SIP INVITE and the receiving of the first RTP packet at the call initiating endpoint.  The media delay value includes the full call setup time and the time it takes to receive the first media packet at the call initiating endpoint.  This statistic is relevant for the call originating endpoint.	Global
Media Delay RX (Avg) [ms], Media Delay RX (Max) [ms], Media Delay RX (Min) [ms]	The per polling interval average/min/max time elapsed between receiving the initial SIP INVITE and receiving the first media packet.  The media delay includes the call setup delay and post-pickup delay.  This statistic is relevant for the call terminating endpoint.	Global
Post-Pickup Delay (Avg) [ms], Post-Pickup Delay (Max) [ms], Post-Pickup Delay (Min) [ms]	The per polling interval average/min/max time elapsed between answering the call and receiving the first media packet.  The post pickup delay is computed as time between the sending of the SIP 200 OK response (after receiving the SIP INVITE) and the receiving of the first RTP packet.  This statistic is relevant for the call terminating endpoint.	Global

<b>VoIPSIP Registrations</b>		
Attempted Registrations	The cumulative count of generated registrations, retransmissions of REGISTER and REGISTER w/ Auth messages not taken into account. This count includes automatic registration or registration refreshes.	Global
Successful Registrations	The cumulative count of registration messages that completed successfully. This count includes automatic registration or registration refreshes.	Global
Failed Registrations	<p>The cumulative count of failed registrations, defined as an initial REGISTER request followed by a final response from the destination registrar or interim proxies indicating a failure. This count includes automatic registration or registration refreshes.</p> <p>A failure response is described as a 4XX (excepting the 401 and 407 responses), 5XX, or 6XX message.</p> <p><b>Notes:</b></p> <ul style="list-style-type: none"> <li>• An unsuccessful registration at loop end is considered a failed registration.</li> <li>• Since registration attempts are often repeated, a failed scenario must identify a failure response associated with the final attempt.</li> </ul>	Global
Attempted De-Registrations	The cumulative count of de-registration attempts computed as the number of sent registrations having a zero Expires header value.	Global
Successful De-Registrations	The cumulative count of de-registration attempts that completed successfully.	Global
Failed De-Registrations	The cumulative count of failed de-registration attempts.	Global
Registration Time (Avg) [ms]	The time elapsed between sending a registration request and receiving a final successful response, in milliseconds.	Global
De-Registration Time (Avg) [ms]	The time elapsed between sending a de-registration request and receiving a final successful response, in milliseconds.	Global
<b>VoIPSIP Registration Rates</b>		

Attempted Registrations /sec	The per polling interval rate of attempted registrations, including automatic registration or registration refreshes.	Global
Successful Registrations /sec	The per polling interval rate of successful registrations, including automatic registration or registration refreshes.	Global
Attempted De-Registrations /sec	The per-polling interval rate of attempted de-registrations, including automatic registration or registration refreshes.	Global
Successful De-Registrations /sec	The per polling interval rate of successful registrations.	Global
<b>VoIPSIP SIP Messages</b>		
Requests Sent	The cumulative count of sent SIP requests.	Global
Requests Parsed	The cumulative count of received and parsed SIP requests.	Global
Requests Matched	The cumulative count of matched SIP requests.	Global
Responses Sent	The cumulative count of sent SIP responses.	Global
Responses Parsed	The cumulative count of received and parsed SIP responses.	Global
Responses Matched	The cumulative count of matched SIP responses.	Global
INVITE Requests Sent	The cumulative count of SIP INVITE messages sent by the client.	Global
INVITE Requests Parsed	The cumulative count of received and parsed SIP INVITE requests.	Global
INVITE Requests Matched	The cumulative count of received, parsed, and matched SIP INVITE requests.	Global
INVITE Requests Retransmitted	The cumulative count of received SIP INVITE requests that were retransmissions.	Global
ACK Requests Sent	The cumulative count of SIP ACK messages sent by the client.	Global
ACK Requests Parsed	The cumulative count of received and parsed SIP ACK requests.	Global

ACK Requests Matched	The cumulative count of received, parsed, and matched SIP ACK requests.	Global
ACK Requests Retransmitted	The cumulative count of received SIP ACK requests that were retransmissions.	Global
BYE Requests Sent	The cumulative count of SIP BYE messages sent by the client.	Global
BYE Requests Parsed	The cumulative count of received and parsed SIP BYE requests.	Global
BYE Requests Matched	The cumulative count of received, parsed, and matched SIP BYE requests.	Global
BYE Requests Internally Matched	The cumulative count of SIP BYE requests that caused a "disconnect" during an RTP function execution, but were not explicitly expected in the test scenario.	Global
BYE Requests Retransmitted	The cumulative count of received SIP BYE requests that were retransmissions.	Global
CANCEL Requests Sent	The cumulative count of SIP CANCEL messages sent by the client.	Global
CANCEL Requests Parsed	The cumulative count of received and parsed SIP CANCEL requests.	Global
CANCEL Requests Matched	The cumulative count of received, parsed, and matched SIP CANCEL requests.	Global
CANCEL Requests Retransmitted	The cumulative count of received SIP CANCEL requests that were retransmissions.	Global
OPTIONS Requests Sent	The cumulative count of SIP OPTIONS messages sent by the client.	Global
OPTIONS Requests Parsed	The cumulative count of received and parsed SIP OPTIONS requests.	Global
OPTIONS Requests Matched	The cumulative count of received, parsed, and matched SIP OPTIONS requests.	Global
OPTIONS Requests Retransmitted	The cumulative count of received SIP OPTIONS requests that were retransmissions.	Global

REGISTER Requests Sent	The cumulative count of sent SIP REGISTER messages.	Global
REGISTER Requests Parsed	The cumulative count of received and parsed SIP REGISTER requests.	Global
REGISTER Requests Matched	The cumulative count of received, parsed, and matched SIP REGISTER requests.	Global
REGISTER Requests Retransmitted	The cumulative count of received SIP REGISTER requests that were retransmissions.	Global
NOTIFY Requests Sent	The cumulative count of sent SIP NOTIFY requests.	Global
NOTIFY Requests Parsed	The cumulative count of received and parsed SIP NOTIFY requests.	Global
NOTIFY Requests Matched	The cumulative count of received, parsed, and matched SIP NOTIFY requests.	Global
NOTIFY Requests Retransmitted	The cumulative count of received SIP NOTIFY requests that were retransmissions.	Global
SUBSCRIBE Requests Sent	The cumulative count total number of sent SIP SUBSCRIBE requests.	Global
SUBSCRIBE Requests Parsed	The cumulative count of received and parsed SIP SUBSCRIBE requests.	Global
SUBSCRIBE Requests Matched	The cumulative count of received, parsed, and matched SIP SUBSCRIBE requests.	Global
SUBSCRIBE Requests Retransmitted	The cumulative count of received SIP SUBSCRIBE requests that were retransmissions.	Global
REFER Requests Sent	The cumulative count of sent SIP REFER requests.	Global
REFER Requests Parsed	The cumulative count of received and parsed SIP REFER requests.	Global
REFER Requests Matched	The cumulative count of received, parsed, and matched SIP REFER requests.	Global
REFER Requests Retransmitted	The cumulative count of received SIP REFER requests that were retransmissions.	Global
MESSAGE Requests Sent	The cumulative count of sent SIP MESSAGE requests.	Global

MESSAGE Requests Parsed	The cumulative count of received and parsed SIP MESSAGE requests.	Global
MESSAGE Requests Matched	The cumulative count cumulative count of received, parsed, and matched SIP MESSAGE requests.	Global
MESSAGE Requests Retransmitted	The cumulative count of received SIP MESSAGE requests that were retransmissions.	Global
INFO Requests Sent	The cumulative count of sent SIP INFO requests.	Global
INFO Requests Parsed	The cumulative count of received and parsed SIP INFO requests.	Global
INFO Requests Matched	The cumulative count of received, parsed, and matched SIP INFO requests.	Global
INFO Requests Retransmitted	The cumulative count of received SIP INFO requests that were retransmissions.	Global
UPDATE Requests Sent	The cumulative count of sent SIP UPDATE requests.	Global
UPDATE Requests Parsed	The cumulative count of received and parsed SIP UPDATE requests.	Global
UPDATE Requests Matched	The cumulative count of received, parsed, and matched SIP UPDATE requests.	Global
UPDATE Requests Retransmitted	The cumulative count of received SIP UPDATE requests that were retransmissions.	Global
PRACK Requests Sent	The cumulative count of sent SIP PRACK requests.	Global
PRACK Requests Parsed	The cumulative count of received and parsed SIP PRACK requests.	Global
PRACK Requests Matched	The cumulative count of received, parsed, and matched SIP PRACK requests.	Global
PRACK Requests Retransmitted	The cumulative count of received SIP PRACK requests that were retransmissions.	Global
UNKNOWN Requests Parsed	The cumulative count of received and parsed SIP UNKNOWN requests.	Global



UNKNOWN Requests Matched	The cumulative count of unknown received, parsed and matched SIP request messages. A SIP request message is considered unknown if the method is none of the INVITE, ACK, OPTIONS, BYE, CANCEL, REGISTER, REFER, NOTIFY, SUBSCRIBE, MESSAGE, PRACK, INFO, UPDATE supported methods.	Global
UNKNOWN Responses Parsed	The cumulative count of received and parsed SIP UNKNOWN responses.	Global
UNKNOWN Responses Matched	The cumulative count of unknown received, parsed, and matched SIP response messages. A SIP response message is considered unknown if the response code is other than 100-699.	Global
1xx responses sent	The cumulative count of sent SIP 1xx response messages.	Global
1xx responses parsed	The cumulative count of received and parsed SIP 1xx response messages.	Global
1xx responses matched	The cumulative count of received, parsed, and matched SIP 1xx response messages.	Global
2xx responses sent	The cumulative count of sent SIP 2xx response messages.	Global
2xx responses parsed	The cumulative count of received and parsed SIP 2xx response messages.	Global
2xx responses matched	The cumulative count of received, parsed, and matched SIP 2xx response messages.	Global
3xx responses sent	The cumulative count of sent SIP 3xx response messages.	Global
3xx responses parsed	The cumulative count of received and parsed SIP 3xx response messages.	Global
3xx responses matched	The cumulative count of received, parsed, and matched SIP 3xx response messages.	Global
4xx responses sent	The cumulative count of sent SIP 4xx response messages.	Global
4xx responses parsed	The cumulative count of received and parsed SIP 4xx response messages.	Global

4xx responses matched	The cumulative count of received, parsed, and matched SIP 4xx response messages.	Global
5xx responses sent	The cumulative count of sent SIP 5xx response messages.	Global
5xx responses parsed	The cumulative count of received and parsed SIP 5xx response messages.	Global
5xx responses matched	The cumulative count of received, parsed, and matched SIP 5xx response messages.	Global
6xx responses sent	The cumulative count of sent SIP 6xx response messages.	Global
6xx responses parsed	The cumulative count of received and parsed SIP 6xx response messages.	Global
6xx responses matched	The cumulative count of received, parsed, and matched SIP 6xx response messages.	Global
Retransmitted Msgs	The cumulative count of retransmitted SIP messages.	Global
Ignored Re-transmissions	The cumulative count of parsed and ignored retransmitted messages following the enabling of the <b>Ignore Retransmissions</b> option.	Global
Requests Orphans	The cumulative count of failures to identify a call recipient for SIP request messages when running in a multiple channels per IP:port configuration.	Global
Responses Orphans	The cumulative count of failures to identify a call recipient for SIP response messages when running in a multiple channels per IP:port configuration.	Global
<b>VoIPSIP Errors</b>		
Transport Errors	The cumulative count of transport errors, occurring when a SIP message could not be sent due to a socket error or a failed DNS server query.	Global
SIP Call Flows Errors	The cumulative count of SIP call flow errors.	Global

SIP Parser Errors	<p>The cumulative count of SIP parser errors. A SIP parser error indicates a message with an invalid request/status line or invalid (malformed) message headers.</p> <p><b>Note:</b> In case the message has parser errors in the mandatory headers (To, From, CSeq, Call-ID, Via), the message is dropped without the statistic being incremented.</p> <p>In case the message has parser errors in the non-mandatory headers, the parser error statistic is incremented and the execution continues with the malformed message, without the message being dropped.</p> <p>At the same time, a new <i>parser_errors.log</i> log file comprising the most recent 100 entries is created on the port CPU in the /tmp/ folder.</p>	Global
SIP SDP Errors	<p>The cumulative count of SIP SDP errors. A SDP error occurs when an invalid SDP is parsed, when two offers or two answers are received in a row in the same session or when the SDP negotiation fails as described in RFC 3264.</p>	Global
SIP Internal Errors	<p>The cumulative count of SIP internal errors.</p>	Global
Trigger Errors	<p>The cumulative count of trigger errors.</p>	Global
RTP Errors	<p>The cumulative count of RTP related errors, incremented when any RTP script function is failing or exiting on the Warning or Timeout outputs. Possible causes include media sessions that have been closed by the signaling engine, or <b>Generate DTMF/MF/Tone</b> or <b>Detect DTMF/MF/Tone</b> functions that failed.</p> <p>This statistic is also incremented when the signaling engine cannot start a media session, such as when the negotiated codec or the negotiatedptime is unsupported.</p>	Global
Internal Errors	<p>The cumulative count of internal errors.</p>	Global
Timeout Errors	<p>The cumulative count of script functions that have timed out.</p>	Global
<b>VoIPSIP Busy Hour Call Measurements</b>		

BHCA	The per polling interval Busy Hour Call Attempts rate that represents the number of calls initiated in one hour.	Global
BHCC	The per polling interval Busy Hour Call Completions rate that represents the number of calls initiated and connected in one hour.	Global
<b>VoIPSIP Other</b>		
Extract Variables Errors	The number of encountered ExtractVariable function errors, occurring when at least one variable could not be extracted.	Global
Requests Sent /s	The number of sent SIP requests per second.	Global
Requests Parsed /s	The number of parsed SIP requests per second.	Global
Requests Matched /s	The number of matched SIP requests per second.	Global
Responses Sent/s	The number of sent SIP responses per second.	Global
Responses Parsed/s	The number of parsed SIP responses per second.	Global
Responses Matched /s	The number of parsed SIP responses per second.	Global
INVITE   ACK   CANCEL   OPTIONS   REGISTER   NOTIFY   SUBSCRIBE   REFER   MESSAGE   INFO   UPDATE   PRACK   UNKNOWN   BYE Requests Sent /s	The rate of SIP requests of the given message type sent.	Global
INVITE   ACK   CANCEL   OPTIONS   REGISTER   NOTIFY   SUBSCRIBE   REFER   MESSAGE   INFO   UPDATE   PRACK   UNKNOWN   BYE Requests Parsed /s	The rate of SIP requests of the given message type parsed.	Global
BYE Requests Internally Matched /s	The rate of BYE messages received when executing RTP functions.	Global

1xx   2xx   3xx   4xx   5xx   6xx Responses Sent /s	The rate of SIP responses of the given type sent.	Global
1xx   2xx   3xx   4xx   5xx   6xx Responses Parsed /s	The rate of SIP responses of the given type parsed.	Global
Retransmitted Msgs /s	The rate of retransmitted SIP messages.	Global
Requests Orphans /s	The rate of failures to identify a call recipient for SIP request messages when running in a multiple channels per IP:port configuration.	Global
Responses Orphans /s	The rate of failures to identify a call recipient for SIP response messages when running in a multiple channels per IP:port configuration.	Global
Bytes Received /s	The incoming SIP byte rate.	Global
TX Messages, TX Messages /s	The number of outbound SIP messages, rate of SIP outbound messages.	Global
TX SIP Msg Length (Avg), TX SIP Msg Length (Min), TX SIP Msg Length (Max)	The Avg/Min/Max outbound SIP message length.	Global
Bytes Transmitted, Bytes Received, Bytes Transmitted /s	The number of SIP bytes sent, received, rate of SIP bytes sent	Global
RX SIP Msg Length (Min), RX SIP Msg Length (Avg), RX SIP Msg Length (Max)	The Avg/Min/Max inbound SIP message length.	Global
RX Messages, RX Messages /sec	The number of inbound SIP messages, rate of inbound SIP messages	Global
Triggers Sent, Triggers Sent /s	The number of triggers sent, rate of triggers sent	Global
Triggers Received, Triggers Received /s	The number of triggers received, rate of triggers received	Global
Triggers Bytes Sent, Triggers Bytes Sent /s	The number of trigger bytes sent, rate of trigger bytes sent.	Global

Triggers Bytes Received, Triggers Bytes Received /s	The number of trigger bytes received, rate of trigger bytes received.	Global
ActiveCallers	The instantaneous value of SIP callers (on the scenario channel that the objective is applied to) that are active at a given time during the test execution. An emulated VoIPSIP caller is considered to be active if he has completed the execution of the Start script function and has not yet reached the Stop function.	Global



**Note:** Statistics from the *Other* category are only stored in application-generated CSV files and are not displayed in any of the predefined views, but can be assigned to custom statistics views of the StatViewer module.

#### EXAMPLE

```
set my_network1 [::IxLoad new ixNetTraffic]
```

```
##### Activity VoIPSIPPeer2 of
NetTraffic my_network1#####set Activity_
VoIPSIPPeer2 [$my_network1 activityList.appendItem \-protocolAndType
"VoIPSIP Peer" ]##### Timelinel for
activity VoIPSIPPeer2,
VoIPSIPPeer3#####set Timelinel
[::IxLoad new ixTimeline]
```

```
$Timelinel config \-rampUpValue 1 \-rampUpType
0 \-offlineTime 0 \-rampDownTime
60 \-standbyTime 0 \-iterations
1 \-rampUpInterval 1 \-sustainTime
80 \-timelineType 0 \-name
"Timelinel"
```

```
$Activity_VoIPSIPPeer2 config \-enable true \-name
"VoIPSIPPeer2" \-enableConstraint false \-userObjectiveValue
1 \-constraintValue 100 \-userObjectiveType
"channels" \-timeline $Timelinel
```

```
$Activity_VoIPSIPPeer2 agent.config \-enable true
\-name "VoIPSIPPeer2"
```

**SEE ALSO**

ixConfig

## Codec Settings

VoIP SIP Peer Codec Settings

### SYNOPSIS

```
$Activity_VoIPSIPPeer1 agent.pm.codecSettings.codecs.appendItem \  
-optionvalue
```

```
$Activity_VoIPSIPPeer1 agent.pm.codecSettings.dataCodecs.appendItem \  
-optionvalue
```

### DESCRIPTION

Codec Settings contains the list of codecs that will be used by the VoIP SIP peers in the test. Codec Settings is a list of one or more `codec` (audio codec) or `dataCodec` objects. To add `codec` or `dataCodec` objects, use the `appendItem` command.

### SUBCOMMANDS

None

### OPTIONS

None.

### EXAMPLE

See the examples for `Data Codecs` and `Codecs`.

### SEE ALSO

[Data Codecs](#)

[Codecs](#)



## Data Codecs

VoIP SIP Peer Data Codecs

### SYNOPSIS

```
$Activity_VoIPSIPPeer1 agent.pm.codecSettings.dataCodecs.appendItem \
-optionvalue
```

### DESCRIPTION

Data Codecs configures a data codec object, which is added to the `Codec Settings` list of codecs.

### SUBCOMMANDS

None.

### OPTIONS

`id`

Codec type. One of the following:

Codec	Description
Rtp2833Events	Named Events Payload format used for carrying DTMF digits and other line and trunk signals as events.
Rtp2833Tones	RTP Payload format that can represent tones consisting of one or more frequencies.

`dPayloadType`

Payload type used for RTP data packets. Default=(see table) min="96" max="127"

Codec	Default value for dPayloadType
Rtp2833Events	100
Rtp2833Tones	101

### EXAMPLE

```
$Activity_VoIPSIPPeer1 agent.pm.codecSettings.dataCodecs.clear
```

```
$Activity_VoIPSIPPeer1 agent.pm.codecSettings.dataCodecs.appendItem \
-id"Rtp2833Events" \
```

```
-dPayloadType100
```

```
$Activity_VoIPSIPPeer1 agent.pm.codecSettings.dataCodecs.appendItem \
```

```
-id"Rtp2833Tones" \
```

```
-dPayloadType101
```

### **SEE ALSO**

[Codec Settings](#)

## Codecs

VoIP SIP Peer Audio Codec

### SYNOPSIS

```
$Activity_VoIPSIPPeer1 agent.pm.codecSettings.codecs.appendItem \
-optionvalue
```

### DESCRIPTION

Codecs configures an audio codec object, which is added to the `Codec Settings` list of codecs.

### SUBCOMMANDS

None.

### OPTIONS

`id`

Codec type. One of the following:

Codec	Description
CodecAMR	Adaptive multi-rate codec
CodecG711u	G.711 mu-law codec
CodecG711a	G.711 A-law codec
CodecG723x153	G.723.1 codec @ 5.3 kbps
CodecG723x163	G.723.1 codec @ 6.3 kbps
CodecG726x16	G.726 codec @ 16 Kbps
CodecG726x24	G.726 codec @ 24 Kbps
CodecG726x32	G.726 codec @ 32 Kbps
CodecG726x40	G.726 codec @ 40 Kbps
CodecG729A	G.729 Annex-A codec
CodecILBC	Internet Low Bit Rate Codec

## Options for CodecAMR

dPayloadIn

Incoming dynamic payload type. Default="98" min="0" max="127".

dPayloadOut

Outgoing dynamic payload type. Default="98" min="0" max="127".

frameSize

Bytes per frame. Must be one of the following: 14. Default=14.

payloadFormat

Payload format.

Value	Usage
0 (default)	Bandwidth-efficient format
1	Octet-aligned format

mode

Codec bit rate. One of the following:

Mode	Description
0 (default)	4.75 kbps
1	5.15 kbps
2	5.90 kbps
3	6.70 kbps
4	7.40 kbps
5	7.95 kbps
6	10.20 kbps
7	12.20 kbps

## Options for CodecG711u

dPayloadIn

---

Incoming dynamic payload type. Default="0" min="0" max="127".

dPayloadOut

Outgoing dynamic payload type. Default="0" min="0" max="127".

frameSize

Bytes per frame. Must be one of the following: 40, 80, 160, 240. Default=160.

### Options for CodecG711a

dPayloadIn

Incoming dynamic payload type. Default="8" min="0" max="127".

dPayloadOut

Outgoing dynamic payload type. Default="8" min="0" max="127".

frameSize

Bytes per frame. Must be one of the following: 40, 80, 160, 240. Default=160.

### Options for CodecG723x153

dPayloadIn

Incoming dynamic payload type. Default="4" min="0" max="127".

dPayloadOut

Outgoing dynamic payload type. Default="4" min="0" max="127".

frameSize

Bytes per frame. Must be one of the following: 20. Default=20.

### Options for CodecG723x163

dPayloadIn

Incoming dynamic payload type. Default="4" min="0" max="127".

dPayloadOut

Outgoing dynamic payload type. Default="4" min="0" max="127".

frameSize

Bytes per frame. Must be one of the following: 24. Default=24.

### Options for CodecG723x163

dPayloadIn

Incoming dynamic payload type. Default="4" min="0" max="127".

dPayloadOut

Outgoing dynamic payload type. Default="4" min="0" max="127".

frameSize

Bytes per frame. Must be one of the following: 24. Default=24.

### Options for CodecG726x16

dPayloadIn

Incoming dynamic payload type. Default="102" min="0" max="127".

dPayloadOut

Outgoing dynamic payload type. Default="102" min="0" max="127".

byteOrder

Byte order.

Option	Description
0 (default)	Big Endian
1	Little Endian

frameSize

Bytes per frame. Must be one of the following: 20, 40, 60. Default=20.

### Options for CodecG726x24

dPayloadIn

Incoming dynamic payload type. Default="103" min="0" max="127".

dPayloadOut

Outgoing dynamic payload type. Default="103" min="0" max="127".

byteOrder

Byte order.

Option	Description
0 (default)	Big Endian
1	Little Endian

frameSize

Bytes per frame. Must be one of the following: 30, 60, 90. Default=30.

### Options for CodecG726x32

dPayloadIn

Incoming dynamic payload type. Default="104" min="0" max="127".

dPayloadOut

Outgoing dynamic payload type. Default="104" min="0" max="127".

byteOrder

Byte order.

Option	Description
0 (default)	Big Endian
1	Little Endian

frameSize

Bytes per frame. Must be one of the following: 40, 80, 120. Default=40.

### Options for CodecG726x40

dPayloadIn

Incoming dynamic payload type. Default="105" min="0" max="127".

dPayloadOut

Outgoing dynamic payload type. Default="105" min="0" max="127".

byteOrder

Byte order.

Option	Description
0 (default)	Big Endian
1	Little Endian

frameSize

Bytes per frame. Must be one of the following: 50, 100, 150. Default=50.

## Options for CodecG729

dPayloadIn

Incoming dynamic payload type. Default="18" min="0" max="127".

dPayloadOut

Outgoing dynamic payload type. Default="18" min="0" max="127".

cbxFrameSize

Bytes per frame. Must be one of the following: 10, 20, 30, 40, 50, Custom. Default=10.

customFrameSize

If cbxFrameSize is Custom, this option configures the custom frame size. Default="120" min="10" max="200".

## Options for CodecILBC

dPayloadIn

Incoming dynamic payload type. Default="97" min="0" max="127".

dPayloadOut

Outgoing dynamic payload type. Default="97" min="0" max="127".

frameSize

Bytes per frame. Must be one of the following: 38, 50, Custom. Default=38.

## EXAMPLE

```
$Activity_VoIPSIPPeer1 agent.pm.codecSettings.codecs.clear
```

```
$Activity_VoIPPeer1 agent.pm.codecSettings.codecs.appendItem \
```

```
-id"CodecG711u" \
```

```
-dPayloadOut0 \
```

```
-dPayloadIn0 \
```

```
-frameSize160
```

```
$Activity_VoIPPeer1 agent.pm.codecSettings.codecs.appendItem \
```

```
-id"CodecG711a" \
```

```
-dPayloadOut8 \
```

```
-dPayloadIn8 \
```



-frameSize160

**SEE ALSO**

[Codec Settings](#)

## Other Settings

### VoIP SIP Peer Other Settings

#### SYNOPSIS

```
$Activity_VoIPSIP Peer1 agent.pm.otherSettings.config \  
-optionvalue
```

#### DESCRIPTION

This object configures the VoIP SIP Peer activity's miscellaneous options.

#### SUBCOMMANDS

None.

#### OPTIONS

VOIP\_Var0

The VOIP\_Var1...VOIP\_Var5 and VOIP\_IPAddr1...VOIP\_IPAddr5 string-type variables supporting generator expressions enable you to generate 10 series of global variables whose values are used at runtime by the simulated endpoints/channels. Default="".

Use the VOIP\_Var1...VOIP\_Var5 variables to represent phone numbers, and the VOIP\_IPAddr1...VOIP\_IPAddr5 to represent IP addresses.

VOIP\_Var1

See VOIP\_Var0.

VOIP\_Var2

See VOIP\_Var0.

VOIP\_Var3

See VOIP\_Var0.

VOIP\_Var4

See VOIP\_Var0.

VOIP\_IPAddress0

See VOIP\_Var0.

VOIP\_IPAddress1

See VOIP\_Var0.

VOIP\_IPAddress2

See VOIP\_Var0.

VOIP\_IPAddress3

See VOIP\_Var0.

VOIP\_IPAddress4

See VOIP\_Var0.

ipPreference

Type of addressing you want to use on the subnet that the VOIP SIP Peer runs on.

Value	Usage
0 (default)	IPv4
1	IPv6

bUseStun

Enables use of a STUN server.

Value	Usage
0 (default)	Disabled
1	Enabled. Configure the STUN server's address and port number in <code>stunAddr</code> and <code>stunPort</code> .

stunAddr

If `bUseStun` is 1, this option configures the STUN server's address. You can include sequence generators in this field to generate multiple addresses. The STUN server address must be an IPv4 address. Default="127.0.0.1".

stunPort

If `bUseStun` is 1, this option configures the STUN port number. You can include sequence generators in this field to generate multiple port numbers. Default="3478".

### EXAMPLE

```
$Activity_VoIPSIPPeer1 agent.pm.otherSettings.config \
-ipPreference0 \
-stunAddr"127.0.0.1" \
-stunPort"3478" \
-bUseStunfalse \
```

```
-VOIP_Var1"" \  
-VOIP_Var0"" \  
-VOIP_Var3"" \  
-VOIP_Var2"" \  
-VOIP_Var4"" \  
-VOIP_IPAddress4"" \  
-VOIP_IPAddress1"" \  
-VOIP_IPAddress0"" \  
-VOIP_IPAddress3"" \  
-VOIP_IPAddress2""
```

### **SEE ALSO**

## Signaling Settings

VoIP SIP Peer Signaling Settings

### SYNOPSIS

```
$Activity_VoIPSIPPeer1 agent.pm.signalingSettings.config \
-optionvalue
```

### DESCRIPTION

This object defines the VoIP Peer SIP settings.

### SUBCOMMANDS

None.

### OPTIONS

enableSIP

Enables use of SIP signaling for the VoIPSIP Peer activity.

0 = SIP disabled

1 = SIP enabled (default)

port

Port used for SIP. You can use Sequence Generators in this field to generate multiple port numbers. See the Sequence Generator appendix for more information. Default="[5060-]".

**Note:** Valid port numbers are between 1000 and 65534.

realm

SIP registration realm (for User Agent Client (UAC) authentication with a registrar). Default="" (null).

user

User name of the emulated device (for User Agent Client (UAC) authentication with a registrar).

Default="Anonymous".

passwd

SIP registration password (for User Agent Client (UAC) authentication with a registrar). Default="" (null).

enableTos

Enables use of TOS/DSCP. Use the `tos` option to specify the TOS/DSCP value.

0 = TOS disabled (default)

1= TOS enabled

tosVal

If `enableTos` is 1, this option sets the value of the TOS bits.

Value	Usage
0 (default)	Best Effort (0x00)
1	Class 1 (0x20)
2	Class 2 (0x40)
3	Class 3 (0x60)
4	Class 4 (0x80)
5	Express Forwarding (0xA0)
6	Control (0xC0)

useServer

Enables use of a proxy server.

0 = disabled (default

1 = enabled

srvAddr

If `useServer` is 1, this option configures the proxy server address. You can use Sequence Generators in this field to generate multiple addresses. See the Sequence Generator appendix for more information. (Default = "").

srvPort

If `useServer` is 1, this option configures the proxy server port number. You can use Sequence Generators in this field to generate multiple port numbers. See the Sequence Generator appendix for more information. (Default="5060")

srvDomain

If `useServer` is 1, this option configures the proxy server domain or local IP address. Default="" (null).

outboundProxy

Enables the use of an outbound Proxy that receives requests from a client, even though it may not be the server resolved by the Request-URI.

0 = disabled (default)

1 = enabled

registrarSrv

Enables the use of a Registrar Proxy, a server that accepts register requests and places the information it receives in requests into the location service for the domain it handles.

0 = disabled (default)

1 = enabled

ovrContact

If set to 1, the default Contact message header (AUTO\_CONTACT) is ignored and the settings specified by Edit Contact are used

0 = disabled (default)

1 = enabled

ovrDest

If set to 1, this parameter enables you to specify a new destination host setting overriding the default setting.

0 = disabled (default)

1 = enabled

ovrDestHostPort

If set to 1, this parameter enables you to specify a new destination port setting overriding the default setting.

0 = disabled (default)

1 = enabled

nUdpMaxSize

Specifies the maximum SIP message size, beyond which messages are truncated, when the used transport protocol is UDP. Min="1024" Max="4000" Default="1024".

telURISource, telURIDest

If configured true, a tel URI is used for source and destination.

enableRetransmissions

If configured true, enables the retransmission of certain SIP messages, both requests and responses, for script functions pertaining to the activity. Retransmission is a mechanism whereby messages are re-sent with a pattern, until either a response message is received or a maximum timeout value is reached.

T1, T2

Specifies the retransmission timers.

ignoreRetransmissions

When selected, this option determines ignoring all the received retransmissions.

ovrTrans

If configured `true`, the preferred transport type for SIP messages can be selected as either of the following, overriding the scenario-level settings:

ovrTransOption

If `ovrTrans` is configured `true`, this parameter specifies the preferred transport as listed in the table below.

0 = UDP only

1 = TCP only

2 = UDP

3 = TCP

tcpWriteImmediate

If configured `true`, SIP messages are sent immediately instead of being queued.

ovrTimeout

If configured `true`, the timeout of the Wait Response (...) and the Wait ACK script functions is specified by the global `64*T1` value, instead of the function-level value.

### EXAMPLE

```
$Activity_VoIPSipPeer1 agent.pm.signalingSettings.config \-tcpWriteImmediate
false \-telURISource                false \-enableSIP
true \-srvPort                       "5060" \-port
"\[5060-]" \-realm                  "" \-ovrDest
false \-nUdpMaxSize                 1024 \-srvDomain
"" \-telURIDest                     false \-ovrTimeout
false \-enableRetransmissions       false \-enableTos
false \-srvAddr                     "" \-ovrDestHostPort
"" \-passwd                          "" \-T2
4000 \-T1                            500 \-outboundProxy
false \-user                         "Anonymous" \-useServer
false \-registrarSrv                false \-tosVal
0 \-ovrContact                      false \-ovrTrans
false \-useDnsSrv                   false \-ovrTransOption
0 \-ignoreRetransmissions           true
```

### SEE ALSO



## Edit Contact

VoIP SIP Peer Edit Contact

### SYNOPSIS

```
$Activity_VoIPSIPPeer1 agent.pm.editContact.config \  
-optionvalue
```

### DESCRIPTION

If the `ovrContact` option in `Contact Settings` is enabled, Edit Contact defines the replacement contact information.

### SUBCOMMANDS

None.

### OPTIONS

`useDomainName`

Domain name to be used.

Value	Usage
0 (default)	Use the domain associated with the source IP address
1	Use the domain specified in <code>domainName</code> .

`domainName`

If `useDomainName` is 1, this option specifies the domain name. Default=`t="mysipdomain.ixiacom.com"`

`_useEPb`

Source of phone number.

Value	Usage
0 (default)	Use the phone number specified in <code>_ePhone</code> .
1	Use the phone number specified by a Phonebook entry.

**Note:** This options appears in the generated tcl code only if the test configuration contains a reference to a Phonebook entry (`_useEPb=1`). The generated tcl script will run only on the machine it has been generated on and only if the corresponding Phonebook entry has not yet been deleted since the generation of the tcl code.

`_ePhone`

If `_useEPb` is 0, this identifies the phone number to be used. Default="160[00000000-]"

`_ckETelURI`

Enable usage of Tel URI parameters.

0 = disabled (default)

1 = enabled. Specify the Tel URI parameters in `_eTelURIParams`.

`_eTelURIParams`

If `_ckETelURI =1`, this option specifies the Tel URI parameters.

Default="phone-context=example.com".

### EXAMPLE

```
$Activity_VoIPSIPPeer1 agent.pm.editContact.config \  
-_useEPb0 \  
-domainName"mysipdomain.ixiacom.com" \  
-_eBp"&lt;None&gt;" \  
-_ePhone"160\[00000000-]" \  
-ePhoneType0 \  
-_eTelURIParams"phone-context=example.com" \  
-useDomainName0 \  
-editTelPar"" \  
-ePhone"160\[00000000-]" \  
-_ckETelURIfalse
```

### SEE ALSO

## RTP Settings

VoIP SIP Peer RTP Settings

### SYNOPSIS

```
$Activity_VoIPSIPPeer1 agent.pm.rtpSettings.config \  
-optionvalue
```

### DESCRIPTION

RTP Settings configures the VoIPSIPPeer RTP transport settings.

### SUBCOMMANDS

None.

### OPTIONS

```
enableRTP
```

Enables use of RTP to transport the media traffic.

0 = disabled (default)

1 = enabled

```
rtpPort
```

RTP port number. Default="10000".

**Note:** Valid port numbers are between 1000 and 65534.

```
enableRTCP
```

Enables the sending and receiving of RTCP packets.

```
chEnableHwAcc
```

If true, enables hardware acceleration for RTP traffic. Default=false.

```
enableAdvStatCalc
```

Enables the computation of advanced RTP statistics.

```
enablePerStream
```

Enables computation of per-stream statistics.

```
enableMDI
```

Enables computation of MDI DF and MDI MLR statistics.

```
enableNBExec
```

If `true`, all RTP functions from a scenario execute in a non-blocking mode, i.e the current function from a channel executes in the background, allowing the execution to continue on that channel with the next script function. Default= `False`.

### EXAMPLE

```
$Activity_VoIPSipPeer1 agent.pm.rtpSettings.config \-enableRTP
true \-enableRTCP false \-enableMDI
false \-chEnableHwAcc true \-chDisableHwAcc
false \-enableAdvStatCalc false \-enablePerStream
false \-rtpPort "[10000-65535,4]" \-enableNBExec
false
```

### SEE ALSO

## Audio Settings

VoIPSIP Peer audio settings

### SYNOPSIS

```
$Activity_VoIPsipPeer1 agent.pm.audioSettings.config \
```

### DESCRIPTION

The Audio Settings configure the VoIPSIP Peer audio RTP settings.

### SUBCOMMANDS

None.

### OPTIONS

```
enableAudio
```

If selected, audio script functions are executed, otherwise they are skipped.

```
audioClip
```

The played audio clip file.

```
playTypeAudio
```

The mode in which the clip is played.

Value	Usage
0 (default)	The clip is played for clip duration or for the duration of the Talk Time parameter in the case of BHCA/CPS/LPS objectives.
1	The clip is played for a user-defined duration.

```
audioDurationUnit
```

The play duration unit, which can be milliseconds (0), seconds (1), minutes (2), or hours (3).

```
outputLevel
```

The output level of the played clip.

```
enableTosRtp
```

Enables use of TOS/DSCP. Use the `rtpTos` option to specify the TOS/DSCP value. Default= False

```
rtpTosVal
```

The Type of Service (TOS/DSCP) byte setting in the sent RTP packets has one of the following values:

- Best Effort (0x00): Routine service

- Class 1 (0x20): Priority service, Assured Forwarding class 1
- Class 2 (0x40): Immediate service, Assured Forwarding class 2
- Class 3 (0x60): Flash, Assured Forwarding class 3
- Class 4 (0x80): Flash-override, Assured Forwarding class 4
- Express Forwarding (0xA0): Critical-ecp
- Control (0xC0): Internet-control
- Custom: A user-specified value.

useMOS

Enables the computation of MOS scores. Default= False.

enableAudioOWD

If true, IxLoad computes the One-way Delay metric, a network measurement specifying the amount of time (in ms) that a packet has spent on the network before it was received on the destination side. Default= False

useJitter

If true, enables use of a jitter buffer. Default= False.

jitMs

If useJitter is 1, this option configures the size of the jitter buffer, in milliseconds. Default="20" min="1" max="3000".

useJitComp

If true, enables dynamic modification of the jitter buffer size. Default= False.

jitCMs

If useJitComp is 1, this option configures the maximum size in of the jitter buffer, in milliseconds. Default="1000" min="0" max="3000".

jitCMaxDrop

If useJitComp is 1, this option configures the condition - a maximum number of consecutive packets dropped - that determines the jitter buffer size to be increased.

enableQoV

If true, this enables QoV P.862 PESQ and P.56 QoV computation. Default= False.

channelTypeQoV

When enableQoV is true, this specifies the objective type as either of the following:

- Number of channels (0)
- Percentage (1)

valueQoV

When `enableQoV` is `true`, this specifies the number of channels for which PESQ and P.56 QoV metrics are computed (when `channelTypeQoV` is 0). Alternatively this represents the percentage of channels for which PESQ and P.56 QoV metrics are computed (when `channelTypeQoV` is 1).

`unitsQoV`

The channels selection mode, which can be any of the following:

- First channels (0)
- Last channels (1)
- Evenly-spaced channels (2)
- Random (3)

`metricsQoV`

When `enableQoV` is `true`, this specifies the metric that is calculated by the Zion card. Available options are:

- PESQ and P.56 (0)
- PESQ (1)
- P56 (2)

`useSilence`

If `true`, RTP packets containing artificial background noise are sent when no other media (DTMF, MF, real payload, and so on) is sent over the communication channel. `Default= False`.

`silenceMode`

If `useSilence` is 1, this option configures the silence mode.

Value	Usage
0	Null data encoded
1 (default)	Comfort noise.

## EXAMPLE

```
$Activity_VoIPSipPeer1 agent.pm.audioSettings.config \-enableAudio
true \-audioClip "US_042.wav" \-playTypeAudio
0 \-audioDurationUnit 1 \-audioDuration
10 \-outputLevel -20-enableAudioOWD
false \-enableTosRtp false \-rtpTosVal
32 \-useMos false \-useJitter
false \-jitMs 20 \-useJitComp
false \-jitCMs 1000 \-jitCMaxDrop
7 \-enableQoV false \-channelTypeQoV
0 \-valueQoV 100 \-unitsQoV
```

```
0 \-activityIdQoV
0 \-useSilence
1 \
```

```
0 \-metricsQoV
false \-silenceMode
```

### **SEE ALSO**



## Video Settings

VoIP SIP Peer Video Settings

### SYNOPSIS

```
$Activity_VoIPSIPPeer1 agent.pm.VideoSettings.config \  
-optionvalue
```

### DESCRIPTION

Video Settings configures the VoIPSIP Peer's video settings.

### SUBCOMMANDS

None.

### OPTIONS

enableVideo

Enables use of video as media traffic.

0 = disabled (default)

1 = enabled

videoClip

Name of the video file. Default = "Fire\_avc.mp4"

playTypeVideo

Determines parameters for running video. Following values are available:

Value	Usage
0 (default)	Play for clip duration
1	Play for specified duration.
2	Conference mode

videoDuration

If `playTypeVideo = 1`, determines duration of video. Maximum value = 259200000.

videoDurationUnit

Unit of duration. Following values are available:

Value	Usage
0	milliseconds
1	seconds
2	minutes
3	hours

`useConference`

If `playTypeVideo = 2`, enables use of conference mode. Following values are available:

Value	Usage
0	All speak
1	Sequential
2	Random

`confVideoDuration`

If `playTypeVideo = 2`, enables selection of conference video duration.

`confVideoDurationUnit`

If `playTypeVideo = 2`, enables selection unit of conference video duration. The following values are available:

Value	Usage
0	milliseconds
1	seconds
2	minutes
3	hours

`confDuration`

If `playTypeVideo = 2`, enables selection of conference audio duration.

`confDurationUnit`

If `playTypeVideo = 2`, enables selection unit of conference audio duration. The following values are available:

Value	Usage
0	milliseconds
1	seconds
2	minutes
3	hours

`enableTosVideo`

Enables use of TOS/DSCP. Use the `tosVideo` option to specify the TOS/DSCP value.

`tosVideo`

The following values are available:

Value	Usage
0	Best Effort (0x00)"
1	Class 1 (0x20)
2	Class 2 (0x40)
3	Class 3 (0x60)
4	Class 4 (0x80)
5	Express Forwarding (0xA0)
6	Control (0xC0)
7	Custom

`useMosVideo`

Enables computation of MOS.

0 = disabled (default)

1 = enabled

**Note:** If MOS computation is enabled, the `enableVideoOWD` option also has to be enabled.

`enableVideoOWD`

If enabled, the One-way Delay metric is computed, a network measurement specifying the amount of time (in ms) that a packet has spent on the network before it was received on the destination side.

Default = disabled.

ignoreHintTrack

If enabled, the hint track present in the video clip is ignored. The video streaming uses a new hint track which is recreated using one of the packetization modes defined by `hintTrackType`. By default it is disabled.

hintTrackType

Allows to select the packetization mode. The following values are available:

Value	Usage
0 (default)	Single NAL Unit
1	STAP-A, with FU-A fragmentation

### EXAMPLE

```
$Activity_VoIPSipPeer1 agent.pm.videoSettings.config \-rotationScheme
0 \-confDuration 1 \-useMosVideo
false \-enableVideoOWD false \-ignoreHintTrack
false \-enableTosVideo true \-enableVideo
true \-videoClip "Fire_avc.mp4" \-
useH323AdvancedSettings false \-videoDuration
5 \-confVideoDurationUnit 1 \-useConference
false \-confDurationUnit 1 \-confVideoDuration
1 \-videoDurationUnit 1 \-hintTrackType
1 \-fmt " \-rtpmap
" \-playTypeVideo 0 \-tosValVideo
32
```

### SEE ALSO

## T.38 Settings

VoIP SIP Peer T.38 Settings

### SYNOPSIS

```
$Activity_VoIPSIPPeer1 agent.pm.Fax(T.38)Settings.config \  
-optionvalue
```

### DESCRIPTION

T.38 Settings configures the VoIP SIPPeer's fax T.38 settings.

### SUBCOMMANDS

None.

### OPTIONS

enableT38

Enables use of 'T.38 Fax Session' script function.

0 = disabled (default)

1 = enabled

t38Port

The T.38 listening port. Default = "40000". This parameter specifies a valid port (1000-65535) or simple sequence generator expression (e.g. [1000-2000,2])

faxImage

Fax image to be sent. Default = "Ixia2Pages.tif"

t38TransportType

The transport protocol used for carrying the T.38 traffic. Default = "1"

The following values are available

Value	Usage
0	TCP
1	UDP

t38UdpEncapsulation

If t38TransportType = 1, t38UdpEncapsulation defines the protocol used to encapsulate T.38 messages. The following values are available:

Value	Usage
0	UDPTL
1	RTP

`t38PayloadType`

The payload type identifier. Minimum = 0, Maximum = 127, and Default = 102

`useFaxVersion`

If enabled, allows selecting the T.38 protocol version.

`faxVersion`

If **useFaxVersion** is enabled, used to identify the T.38 protocol version, 0, 1, 2, or 3 (default = 0).

`useT38MaxBitrate`

If enabled, allows selecting the maximum fax transmission rate.

`t38MaxBitrate`

The maximum fax transmission rate supported by the endpoint (default = 5). The following values are allowed:

Value	Usage
0	2.4 kbps
1	4.8 kbps
2	7.2 kbps
3	9.6 kbps
4	12 kbps
5 (default)	14.4 kbps
6	16.8 kbps
7	19.2 kbps
8	21.6 kbps
9	24 kbps
10	26.4 kbps

11	28.8 kbps
12	31.2 kbps
13	33.6 kbps

useT38RateMgmt

If enabled, allows selecting the fax rate management model.

t38RateMgmt

The fax rate management model as defined in T.38. Following values are allowed:

Value	Usage
0	Transferred TCF
1	Local TCF

useErrorRecoverySchema

If enabled, allows selecting the desired error correction scheme.

errorRecoverySchema

The desired error correction scheme. The following values are allowed:

Value	Usage
0 (default)	Redundancy
1	FEC

useT38MaxDatagramSize

If enabled, allows selecting the maximum datagram size.

t38MaxDatagramSize

The maximum datagram size (default = 256), which represents the maximum number of bytes that can be stored on the remote device before an overflow condition occurs. Minimum = 0, Maximum = 256.

### EXAMPLE

```
$Activity_VoIPSipPeer1 agent.pm.t38Settings.config \-enableT38
true \-t38TranscodingMMR                false \-t38UdpEncapsulation
0 \-useT38MaxBitrate                     true \-t38RateMgmt
0 \-t38TranscodingJBIG                   false \-t38TransportType
1 \-t38Port                               "40000" \-t38FillBitRemoval
0 \-faxVersion                            0 \-useT38FillBitRemoval
```

```
false \-useT38RateMgmt                true \-faxImage
"Ixia2Pages.tif" \-useT38MaxBufferSize  false \-
errorRecoverySchema                    0 \-t38MaxDatagramSize
256 \-t38MaxBufferSize                 200 \-useFaxVersion
true \-useT38MaxDatagramSize           true \-t38MaxBitrate
5 \-t38PayloadType                     102 \-useErrorRecoverySchema
true
```

### **SEE ALSO**



## T.30 Settings

VoIP SIP Peer T.30 Settings

### SYNOPSIS

```
$Activity_VoIPSIPPeer1 agent.pm.Fax(T.30)Settings.config \
-optionvalue
```

### DESCRIPTION

T.30 Settings configures the VoIP SIPPeer's fax T.30 settings.

### SUBCOMMANDS

None.

### OPTIONS

t30StationId

The fax station's identifier sent in CSI, TSI and CIG. Required valid station ID or sequence generator expression (e.g. '5551[000-]'). Default = "5551[000-]"

t30SendCoding

The highest coding scheme available to compress the page data when sending. The following values are available:

Value	Usage
0	MH
1	MR
2 (Default)	MMR

t30SendDataRate

The data rate for sending. The following values are available:

Value	Usage
0	V.27 ter 2.4
1	V.27 ter 4.8
2	V.17 7.2

3	V.17 9.6
4	V.17 12
5(default)	V.17 14.4
6	V.29 7.2
7	V.29 9.6
8	V.34 16.8
9	V.34 19.2
10	V.34 21.6
11	V.34 24
12	V.34 26.4
13	V34 28.8
14	V.34 31.2
15	V34 33.6

t30SendPageSize

The page size for sending. The following values are available:

Value	Usage
0	A4 (210x297 mm)
1	B4 (255x364 mm)
2	A3 (297x420 mm)

t30SendMSLT

The minimum transmission time of one coded scan line. Default = 0

The following values are available:

Value	Usage
0 (default)	Auto (based on DIS)
1	5 ms T7.7 = T3.85

2	10 ms T7.7 = 1/2 T3.85
3	10 ms T7.7 = T3.85
4	20 ms T7.7 = 1/2 T3.85
5	20 ms T7.7 = T3.85
6	40 ms T7.7 = 1/2 T3.85
7	40 ms T7.7 = T3.85

t30SendProtocol

The protocol used for fax sending. The following values are available

Value	Usage
0	non-ECM
1 (default)	ECM.

t30SendResolution

The horizontal and vertical resolution of the page image. The following values are available

Value	Usage
0 (default)	R8x3.85 lines/mm
1	R8x7.7 lines/mm
2	R8x15.4 lines/mm
3	200x200 dots/inch

sendCNG

If enabled, CNG message is sent.

t30ReceiveCoding

The highest coding scheme available to compress the page data when receiving. The following values are available:

Value	Usage
0	MH

1	MR
2 (Default)	MMR

t30ReceivePageSize

The page size for receiving. The following values are available:

Value	Usage
0	A4 (210x297 mm)
1	B4 (255x364 mm)
2 (default)	A3 (297x420 mm)

t30ReceiveMSLT

The minimum transmission time of one coded scan line. Default = 0

The following values are available:

Value	Usage
0 (default)	0 ms T7.7 = T3.85
1	5 ms T7.7 = T3.85
2	10 ms T7.7 = 1/2 T3.85
3	10 ms T7.7 = T3.85
4	20 ms T7.7 = 1/2 T3.85
5	20 ms T7.7 = T3.85
6	40 ms T7.7 = 1/2 T3.85
7	40 ms T7.7 = T3.85

t30ReceiveProtocol

The protocol used for fax receiving. The following values are available:

Value	Usage
0	non-ECM
1 (default)	ECM.

sendCedBeforeDIS

If enabled, allows the answering fax to send a CED (Called station Id) signal.

t30ReceiveModulations

Allows to select the receiving protocol. The following values are available:

Value	Usage
0	V.27
1 (default)	V.27/V.29
2	V.27/V.29/V.17
3	V.27/V.29/V.17/V.34

t30ReceiveR8x3

If enabled, receive resolution is R8x3.85 lines/mm.

t30ReceiveR8x7

If enabled, receive resolution is R8x7.7 lines/mm.

t30ReceiveR8x15

If enabled, receive resolution is R8x15.4 lines/mm.

t30Receive200x200

If enabled, receive resolution is 200x200 dots/inch.

## EXAMPLE

```
$Activity_VoIPSipPeer1 agent.pm.t30Parameters.config \
```

```
-t30SendResolution          0 \
-sendCedBeforeDIS          1 \
-t30ReceiveR8x7            true \
-t30SendPageSize           0 \
-t30ReceiveR8x3            true \
-t30SendProtocol           1 \
-t30ReceiveProtocol        1 \
-sendCNG                    1 \
-t30SendCoding             0 \
```

```
-t30ReceiveMSLT          0 \  
-t30SendMSLT             0 \  
-t30ReceiveCoding        2 \  
-t30ReceivePageSize      2 \  
-t30ReceiveModulations   3 \  
-t30ReceiveR8x15        true \  
-t30StationId            "5551\[000-\]" \  
-t30SendDataRate         5 \  
-t30Receive200x200      true
```

**SEE ALSO**

## Timer Settings

VoIP SIP Peer Timer Settings

### SYNOPSIS

```
$Activity_VoIPSIPPeer1 agent.pm.TimerSettings.config \  
-optionvalue
```

### DESCRIPTION

Timer Settings configures the VoIP SIPPeer's timer settings.

### SUBCOMMANDS

None.

### OPTIONS

```
enableTimers
```

If enabled, the session refresh mechanism according to RFC4028 (Session Timers in SIP) and the registration refresh mechanism according to RFC3261 (Session Initiation Protocol) is allowed.

```
expirationValList
```

Defines the expiration value for each message.

```
sessionRefreshType
```

Allows you to select the session refresh time. The following values are available:

Value	Usage
0	After specified seconds.
1 (default)	After specified % of negotiated value.
2	With specified seconds before expiration

```
refreshAfterSecs
```

If sessionRefreshType = 0, minimum = 1, maximum = 9999, and default = 3000

```
refreshAfterPercent
```

If sessionRefreshType = 1, minimum = 1, maximum = 100, and default = 50

```
refreshInSecs
```

If sessionRefreshType = 2, minimum = 1, maximum = 9999, and default = 32

`enableRetransmissions`

If enabled, allows retransmission of certain SIP messages, both requests and responses, for script functions pertaining to the activity.

`ignoreRetransmissions`

If enabled, determines ignoring all the received retransmissions.

`retransmitACK`

If enabled, allows retransmission of the 200 Ok final response to an INVITE transaction causes the ACK message, in accordance with the provisions of RFC3261.

`autoEndCall`

If enabled, allows automatic deletion of active calls at the end of test loops

### EXAMPLE

```
$Activity_VoIPSipPeer1 agent.pm.timerSettings.config \-enableRetransmissions
false \-retransmitACK true \-refreshInSecs
32 \-refreshAfterSecs 3000 \-T2
4000 \-T1 500 \-refreshAfterPercent
50 \-ignoreRetransmissions true \-ovrTimeout
false \-sessionRefreshType 1 \-autoEndCall2
true \-enableTimers false
```

### SEE ALSO



## SRTP Settings

VoIP SIP Peer SRTP Settings

### SYNOPSIS

```
$Activity_VoIPSIPPeer1 agent.pm.srtpSettings.config \
-optionvalue
```

### DESCRIPTION

SRTP Settings configures the VoIP SIPPeer's SRTP settings.

### SUBCOMMANDS

None.

### OPTIONS

benableSRTP

Enables use of SRTP to transport the media traffic.

- false = disabled (default)
- true = enabled

bDisableSRTPAuthentication

If true, this option disables SRTP authentication.

bDisableSRTPEncryption

If true, this option disables SRTP stream encryption.

bIncludeMKI

If true, the generated SRTP packets include the MKI field.

bDisableValidations

If true, none of the validations below are performed on the received SRTP packets:

- SRTP packet authentication tag is not verified
- Master Key expiration is not verified
- SRTP packet MKI field is ignored

bDisableSRTCPEncryption

If true, this option disables SRTCP stream encryption.

bAllowOnlySecureStreams

If true, the SDP offer comprises only secure streams and SDP negotiates only secure streams.

bDisableMasterSalt

If true, the Master Salt value is null instead of it being randomly generated.

bStaticMasterKeySalt

If true, this option determines the use of a static master key and salt.

\_masterKeySelection

Specifies if a single key or multiple keys are used:

- 0 = A single key is used. The key is specified by the `staticSingleKeySalt` parameter.
- 1 = Multiple static keys are used. Keys are obtained from a file specified by the `staticKeyFile` parameter.

staticSingleKeySalt

If `bStaticMasterKeySalt` is true, this parameter defines a key value.

staticKeyFile

If `bStaticMasterKeySalt` is true, this parameter defines a file containing multiple key values.

### EXAMPLE

```
$Activity_VoIPSipPeer1 agent.pm.srtpSettings.config \-bDisableSRTPAuthentication
false \-bIncludeMKI true \-bEnableSRTP
true \-bDisableValidations false \-bDisableSRTCPEncryption
false \-bStaticMasterKeySalt true \-bAllowOnlySecureStreams
false \-bDisableMasterSalt false \-staticSingleKeySalt
"BjVFszwVXnYB2Rtr6BbFfbvDkuFtUjJWUCClq4gP" \-staticKeyFile
"" \-bDisableSRTPEncryption false \-_masterKeySelection
0
```

### SEE ALSO

## MSRP Settings

VoIPSIP Peer MSRP Settings

### SYNOPSIS

```
$Activity_VoIPSIPPeer1 agent.pm.msrpSettings.config \  
-optionvalue
```

### DESCRIPTION

Configures the settings for the MSRP endpoints emulated by a VoIPSIP Peer activity..

### SUBCOMMANDS

None

### OPTIONS

`enableMSRP`

Enables or disable MSRP emulation.

- `false` = disabled (default)
- `true` = enabled

`msrpPort`

Specifies the MSRP listening port (default 2855).

`domainType`

Defines the domain type, which can be specified using a domain name (for a '0' value) or using an IP address (for a '1' value).

`localDomain`

When the `domainType` parameter is configured to a value of '0', this specifies the name of the local domain, possibly using a sequence generator expression.

`relaysCount`

Specifies the number of configured MSRP relays.

`firstRelayIsIPv4`

If `true` (and if `firstRelayIpEnabled` is configured `true`), it specifies that the `firstRelayIp` parameter contains an IPv4 address, otherwise it contains an IPv6 address.

`firstRelayIpEnabled`

If `true`, the first relay is specified using an IP address.

`firstRelayIp`

Specifies the IP address of the first relay.

`msrpRelayPort`

Specifies the first relay's listening port.

`automaticMSRPAuth`

If selected, the emulated MSRP endpoints are authenticated at the start of the execution against all defined relay servers. The used credentials are those used by the emulated UAs of the VoIPSIP activity.

`msrpReuseTCP`

If `true`, the MSRP endpoint re-uses an existing TCP connection when establishing a new MSRP session.

`msrpSessionTimeout`

Specifies the time after which the session is closed (ms).if no connection was established or no data was received.

`msrpTransactionTimeout`

Specifies how long (the time period is expressed in ms) an MSRP endpoint waits for a response to a sent MSRP request.

`msrpFirstChunkTimeout`

Specifies the period of time an MSRP endpoint waits for a message to arrive (ms).

`msrpInterChunkTimeout`

Specifies how long an MSRP endpoint waits for receiving subsequent chunks from a multipart ('chunked') message (ms).

`enableMSRPTos`

Enables use of TOS/DSCP. Use the `tosMSRPVal` option to specify the TOS/DSCP value.

`tosMSRPVal`

The following values are available:

Value	Usage
0	Best Effort (0x00)"
1	Class 1 (0x20)
2	Class 2 (0x40)
3	Class 3 (0x60)
4	Class 4 (0x80)

5	Express Forwarding (0xA0)
6	Control (0xC0)
7	Custom

**EXAMPLE**

```

$Activity_VoIPSipPeer1 agent.pm.msrpSettings.config \
-tosMSRPVal          0 \
-relaysCount         2 \
-domainType          0 \
-enableMSRPTos       false \
-firstRelayIpEnabled true \
-msrpRelayPort        2855 \
-msrpFirstChunkTimeout 60000 \
-msrpReuseTCP         true \
-automaticMSRPAuth   true \
-firstRelayIp         "10.10.10.1" \
-msrpInterChunkTimeout 30000 \
-firstRelayIsIPv4     true \
-msrpTransactionTimeout 30000 \
-msrpSessionTimeout 10000 \
-msrpPort             "2855" \
-enableMSRP           true \
-localDomain           "alice\[00-99\].example.com"

```

**SEE ALSO**

[MSRP Relays](#)

[MSRP GUI Files](#)

## MSRP GUI Files

VoIP SIP Peer MSRP GUI Files

### SYNOPSIS

```
$Activity_Make_Call agent.pm.msrpSettings.msrpGuiFiles.appendItem \  
-optionvalue
```

### DESCRIPTION

Configures the VoIP SIP Peer's files transmitted over established MSRP sessions.

### SUBCOMMANDS

None

### OPTIONS

synthetic

Defines the file type, synthetic (for a '0' value) or real (for a '1' value).

name

The file name (for both synthetic and real files).

type

Depending on the transmitted file type, this parameter needs configured to either values:

- plain/text
- application/octet-stream
- binary/octet-stream
- image/jpeg
- video/mpeg
- audio/basic

fileClientPath

The complete file path for real files to be transmitted.

size

The file size in bytes.

### EXAMPLE

```
$Activity_Make_Call agent.pm.msrpSettings.msrpGuiFiles.appendItem \  
-id "FileRecord" \  
-optionvalue
```

```
-synthetic          0 \  
-name              "synthetic_1.bin" \  
-fileHash          "" \  
-nameSynthetic     "synthetic_1.bin" \  
-type              "application/octet-stream" \  
-fileClientPath    "" \  
-size              20971520
```

**SEE ALSO**

[MSRP Settings](#)

[MSRP Relays](#)

## MSRP Relays

MSRP Relays

### SYNOPSIS

```
$Activity_VoIPSIPPeer1 agent.pm.msrpSettings.relays.appendItem \  
-optionvalue
```

### DESCRIPTION

Configures a list of MSRP relays.

### SUBCOMMANDS

None

### OPTIONS

relayAddress

Specifies an MSRP relay address.

addressPort

Specifies the relay MSRP port, or 0 if the default port is to be used.

### EXAMPLE

```
$Activity_VoIPSipPeer1 agent.pm.msrpSettings.relays.clear
```

```
$Activity_VoIPSipPeer1 agent.pm.msrpSettings.relays.appendItem \  
-id "RelayServer" \  
-RelayAddress "relay1.example.com" \  
-AddressPort 0
```

### SEE ALSO

[MSRP Settings](#)



## Custom Activity Link Settings

VoIP SIP Peer CustomActivityLinkSettings

### SYNOPSIS

```
$Activity_VoIPSIPPeer1 agent.pm.customActivityLinkSettings.config \
-option value
```

### DESCRIPTION

CustomActivityLinkSettings configures the BHCA and CPS objective settings for VoIP SIP Peer activities. This options in this object correspond to the controls on the Custom Parameters tab for a NetTraffic/ActivityLink in the Timeline and Objective branch of the Test Configuration tree in the GUI.

**Note:** The CustomActivityLinkSettings class has to be configured alongside the CustomParameters class that implements the same functionality.

### SUBCOMMANDS

None.

### OPTIONS

bhcaObjectiveValue

The BHCA test objective value. Default="80000".

bhcaType

Determines how the BHCA objective will be met: by specifying the talk time or the number of channels.

Value	Usage
0 (default)	BHCA will be met by specifying the talk time. Specify the talk time in <code>talkTime</code> .
1	BHCA will be met by specifying the number of channels. Specify the number of channels in <code>channelsNo</code> .

talkTime

If `bhcaType` is 0, this option specifies the Talk Time that will be used to attain the BHCA test objective. Default="40000".

channelsNo

If `bhcaType` is 1, this option specifies the number of channels that will be used to attain the BHCA test objective. Default="100".

callSetupTime

Estimated call setup time. Default="500".

callTeardownTime

Estimated call teardown time. Default="500".

interCallDuration

Inter-call duration. Default="4000".

cpsObjectiveValue

The CPS test objective value.

cpsType

Determines how the CPS objective will be met: by specifying the talk time or the number of channels.

Value	Usage
0 (default)	CPS objective will be met by specifying the talk time. Based on the the talk time value specified in <code>talkTime</code> , the <code>cpsChannelsNo</code> value is computed.
1	CPS objective will be met by specifying the number of channels. Based on the the channels number value specified in <code>cpsChannelsNo</code> , the <code>talkTime</code> value is computed.

cpsTalkTime

If `cpsType` is 0, this option specifies the Talk Time that will be used to attain the CPS test objective. Default="40000".

cpsChannelsNo

If `bhcaType` is 1, this option specifies the number of channels that will be used to attain the CPS test objective. Default="100".

cpsOverheadTime

Indicates the duration of all other actions on the channel except the talk time and minimum inter-call duration.

cpsInterCallDuration

The minimum time interval between the end of a call on a Voice channel and the start of a new call on the same voice channel

### EXAMPLE

```
$Activity_Make_Call agent.pm.customActivityLinkSettings.config \-talkTime
40000 \-cpsObjectiveValue           100 \-cpsType
0 \-cpsInterCallDuration            2000 \-channelsNo
100 \-cpsTalkTime                   750 \-cpsOverheadTime
1500 \-cpsChannelsNo                425 \-bhcaType
```

0 \-callTeardownTime	500 \-interCallDuration
4000 \-bhcaObjectiveValue	100 \-callSetupTime
500	

**SEE ALSO**

## Execution Settings

VoIP SIP Peer Execution Settings

### SYNOPSIS

```
$Activity_<VoIPSIPPeer activity name>agent.pm.executionSettings.config \  
-optionvalue
```

### DESCRIPTION

This object defines the execution settings for the VoIP SIP Peer activity.

### SUBCOMMANDS

None.

### OPTIONS

loopMode

Defines how many loops are executed for every voice channel corresponding to this activity.

Value	Description
0 (default)	Loop for the entire test duration.
1	Execute a number of loops. Specify the number of loops in loopCount.

loopCount

If loopMode is 1, this option defines the number of loops that the test performs. Default="1".

loopPreDelay

Delay before first loop (ms). Default="0", min="0" max="3600000".

loopMidDelay

Delay between loops (ms). Default="0" min="0" max="3600000".

aliases

Number of aliases (phone numbers) per channel. Default="1", min="1" max="16000".

multipleUsersPerIO

Specifies if multiple VoIPSIP channels can share the same IP:port.

ipRule

A simulated VoIPSIP channel is uniquely identified by IP address, TCP/UDP/TLS port, and Phone number. This option selects the rule used for the IP address portion of the channel mapping rule.

- 0 = Use same value (per port)
- 1 = Use consecutive values (per port) (default)
- 2 = Use same value for every x channels. Specify the value for x in `-ipRuleCh`.

`ipRuleCh`

If `ipRule` is Use same value every, this specifies the number of channels. (Default="1" min="1" max="100000")

`portRule`

A simulated VoIPSIP channel is uniquely identified by IP address, TCP/UDP/TLS port, and Phone number. This option selects the rule used for the TCP/UDP portion of the channel mapping rule.

- 0 = Use same value (default)
- 1 = Use consecutive values (per port)
- 2 = Use consecutive values (per activity)
- 3 = Use same value for every x channels. Specify the value for x in `-portRuleCh`.

`portRuleCh`

If `portRule` is Use same value every, this specifies the number of channels. (Default="1" min="1" max="100000").

`phoneRule`

A simulated VoIPSIP channel is uniquely identified by IP address, TCP/UDP/TLS port, and Phone number. This option selects the rule used for the Phone number portion of the channel mapping rule.

- 0 = Use consecutive values (per port) (default)
- 1 = Use consecutive values (per activity)

`rtpIpRule`

A simulated RTP channel is uniquely identified by the IP address and UDP port. This option selects the rule used for the IP address portion of the RTP channel allocation.

- 0 = Use same value (per port) (default)
- 1 = Use consecutive values (per port)
- 2 = Use same value for every x channels. Specify the value for x in the `rtpIpRuleCh` parameter.

`rtpIpRuleCh`

If `rtpIpRule` is Use same value every, this parameter specifies the number of channels.

`rtpPortRule`

This option selects the rule used for the port portion of the RTP channel allocation.

- 0 = Use same value (default)

- 1 = Use consecutive values (per port)
- 2 = Use consecutive values (per activity)
- 3 = Use same value for every x channels. Specify the value for X in `rtpPortRuleCh`.

`rtpPortRuleCh`

If `rtpPortRule` is Use same value every, this parameter specifies the number of channels.

**EXAMPLE**

```
$Activity_VoIPSipPeer1 agent.pm.executionSettings.config \-portRuleCh
1 \-rtpPortRule                0 \-multipleUsersPerIO
false \-loopMidDelay           0 \-loopCount
1 \-rtpIpRule                  1 \-rtpIpRuleCh
1 \-rtpPortRuleCh             1 \-loopPreDelay
0 \-loopMode                   0 \-phoneRule
0 \-portRule                   0 \-ipRule
1 \-ipRuleCh                   1 \-aliases
1
```

**SEE ALSO**

## Transfer Address

VoIP SIP Peer Transfer Address

### SYNOPSIS

```
$Activity_VoIPSIPPeer1 agent.pm.transferAddress.config \  
-option value
```

### DESCRIPTION

Transfer Address configures a SIP transfer address (see RFC 3261).

### SUBCOMMANDS

None.

### OPTIONS

`symTransferStr`

Name of the VoIP SIP Peer configured as transfer destination (Default="None").

`overridePhoneNo`

Enables override of phone numbers from destination VoIP SIP Peer.

Value	Usage
0 (default)	Disabled
1	Enabled

`_useTPb`

If `overridePhoneNo` is 1, this option selects the source of the replacement phone numbers.

Value	Usage
0 (default)	Use phone number specified by <code>_tPhone</code> .
1	Use phone number specified by Phonebook entry.

**Note:** This options appears in the generated Tcl code only if the test configuration contains a reference to a Phonebook entry (`_useTPb=1`). The generated tcl script will run only on the machine it has been generated on and only if the correspon-ding Phonebook entry has not yet been deleted since the generation of the Tcl code.

`_tPhone`

If `_useTPb` is 0, this option specifies the replacement phone numbers. You can use sequence generators in this field. Default="150[00000000-]".

`_ckTTelURIParams`

Enables insertion of Tel URI parameters.

Value	Usage
0 (default)	Disabled
1	Enabled

`_tTelURIParams`

If `_ckTTelURIParams` is 1, this option specifies the Tel URI parameters. Default="phone-context=example.com".

### EXAMPLE

```
$Activity_VoIPSIPPeer1 agent.pm.transferAddress.config \  
-overridePhoneNofalse \  
-_useTPb0 \  
-tPhone"150\[00000000-]" \  
-transTelPar"" \  
-_tPhone"150\[00000000-]" \  
-_ckTTelURIParamsfalse \  
-symTransferStr"None" \  
-tPhoneType0 \  
-_tTelURIParams"phone-context=example.com" \  
-_tBp"&lt;None&gt;"
```

### SEE ALSO



## Scenario Settings

VoIP SIP Peer Scenario Settings

### SYNOPSIS

```
$Activity_VoIPSIPPeer1 agent.pm.scenarioSettings.config \  
-option value
```

### DESCRIPTION

Scenario Settings specifies the test scenario file used by the Tcl script.

### SUBCOMMANDS

None.

### OPTIONS

scenarioFile

The full path to the test scenario file for the activity.

activeScenarioChannel

Test scenario channel (0-based index) that is associated with the VoIP SIP Peer activity (Default=0) .

### EXAMPLE

```
$Activity_VoIPSIPPeer1 agent.pm.scenarioSettings.config \  
-scenarioFile"E:\\ScenarioTestFiles\\Basic_Call_TCP.tst" \  
-activeScenarioChannel0
```

### SEE ALSO

## Dial Plan

VoIP SIP Peer Dial Plan

### SYNOPSIS

```
$Activity_VoIPSIPPeer1 agent.pm.dialPlan.config \  
-option value
```

### DESCRIPTION

The Dial Plan object configures the source, destination, and transfer addresses and phone numbers for the channels/endpoints simulated by the VoIPSIPPeer activity.

### SUBCOMMANDS

None.

### OPTIONS

sourceIPs

List of IPs taken from the associated network (read-only).

`_useSPb`

Method used to select phone number.

Value	Usage
0	Use the phone number specified by pattern.
1	Use the phone number specified by Phonebook entry.

**Note:** This options appears in the generated tcl code only if the test configuration contains a reference to a Phonebook entry (`_useSPb=1`). The generated Tcl script will run only on the machine it has been generated on and only if the corresponding Phonebook entry has not yet been deleted since the generation of the Tcl code.

`_sPhone`

If `_useSPb` is 0, this option specifies the phone number. You can use sequence generators in this field to generate multiple phone numbers. See the sequence generator appendix. Default="160[00000000-]".

`_ckSTelURIParams`

Enables insertion of Tel URI parameters.

Value	Usage
0 (default)	Disabled
1	Enabled

`_sTelURIParams`

If `_ckSTelURIParams` is 1, this option specifies the Tel URI parameters. Default="phone-context=example.com".

`symDestStr`

String identifying the VoIP SIP Peer or VoIP Skinny Peer that is the destination for traffic from this VoIP SIP Peer activity. Default="None".

`ovrDestPhone`

Enables overriding of phone number from the destination VoIP Peer.

Value	Usage
0 (default)	Disabled
1	Enabled

`_useDPb`

Method used to select the phone number used to override destination phone number.

Value	Usage
0 (default)	Specify pattern.
1	Specify Phonebook entry.

**Note:** This options appears in the generated tcl code only if the test configuration contains a reference to a Phonebook entry (`_useDPb=1`). The generated Tcl script will run only on the machine it has been generated on and only if the corresponding Phonebook entry has not yet been deleted since the generation of the Tcl code.

`_dPhone`

If `_useDPb` is 0, this option specifies the phone number. Default="170[00000000-]".

`_ckDTelURIParams`

Enables insertion of Tel URI parameter.

Value	Usage
-------	-------

0 (default)	Disabled
1	Enabled

`_dTelURIParams`

If `_ckDTelURIParams` is 1, this option configures the Tel URI parameters. Default="phone-context=example.com".

### EXAMPLE

```
$Activity_VoIPSIPPeer1 agent.pm.dialPlan.config \  
-_useSPb0 \  
-symDestStr"sip server_VoIPSIPPeer2:5060" \  
-_sTelURIParams"phone-context=example.com" \  
-destPhoneType0 \  
-_sPhone"160\[00000000-\]" \  
-_dTelURIParams"phone-context=example.com" \  
-_sBp"&lt;None&gt;" \  
-srcPhoneType0 \  
-_dBp"&lt;None&gt;" \  
-ovrDestPhonefalse \  
-destTelPar"" \  
-_ckSTelURIParamsfalse \  
-_dPhone"170\[00000000-\]" \  
-srcPhone"160\[00000000-\]" \  
-destPhone"160\[00000000-\]" \  
-_useDPb0 \  
-_ckDTelURIParamsfalse \  
-srcTelPar""
```

### SEE ALSO

## TLS Settings

Configures VoIP SIP Peer TLS settings.

### SYNOPSIS

```
$Activity_VoIPSIPPeer1 agent.pm.tlsSettings.config \  
-optionvalue
```

### DESCRIPTION

Specifies TLS settings for SIP traffic.

### SUBCOMMANDS

None.

### OPTIONS

`enableTLS`

Enables use of TLS to transport the SIP traffic.

`false` = disabled (default)

`true` = enabled

`tlsProtocol`

Specifies the TLS protocol version used:

- 0 = TLS 1.0 Only (Default)
- 1 = SSL 3.0 Only
- 2 = TLS + SSL

`tlsPort`

Specifies the TLS listening port (default=5061).

`tlsEnableTcpKeepAlive`

If configured `true`, enables the TCP keep alive mechanism on the VoIPSIPPeer-emulated endpoints.

`tlsReuseConnection`

If configured `true`, an `alias` parameter is added in the Via header of SIP requests sent by the VoIPSipPeer activity, such as to enable the TLS connection reuse mechanism.

When this option is set to the `true` value, the Mutual Authentication option is automatically selected.

`tlsMutual`

If configured `true`, mutual authentication is performed. When this parameter is configured `true`, the `tlsAuthClient` option also has to be configured `true`.

`tlsAuthClient`

If configured `true`, client authentication at the TLS connection establishment stage is also performed. By default, only the server authenticates itself by presenting a certificate.

`tlsSessionRefresh`

If configured `true`, TLS renegotiation is enabled at the interval of time specified by the `tlsRefreshInterval` parameter.

`tlsRefreshInterval`

When the `tlsSessionRefresh` option is configured `true`, this parameter specifies the refresh interval.

`ignoreSubjectAltName`

If configured `true`, the verification of the Subject Alternative Name certificate parameter is not performed and the connection is re-used for which the ``alias'` parameter of the `Via` header was received.

`sipScheme`

Specifies the scheme, `sip` or `sips`, used for the construction of the Request-URI for the following SIP message headers: Contact, From, To, Reply-To, Via, Record-Route.

0 = sip

1 = sips

`tlsTransportType`

Specifies the transport protocol – TCP or TLS – used in the construction of SIP Request-URIs, the Contact message header and the ``sent-protocol'` parameter of Via message headers

0 = TCP

1 = TLS

`tlsDisableUdpAndTcp`

If `true`, the VoIPSIP peer only accepts TLS connections, rejecting any UDP or TCP connections.

`tlsCertificatesPath`

Specifies the certificates location, a folder containing the certificates files. Default = "".

`tlsPublicKeyCertificate`

Specifies the name of the certificate file containing the public key, or a sequence specifying a set of certificate file names.

`tlsPrivateKeyCertificate`

Specifies the name of the certificate file containing the private key, or a sequence specifying a set of certificate file names.

tlsPassword

Specifies an optional parameter, defined as a string or a sequence, representing the password used to encrypt the private key. Default = "".

### EXAMPLE

```
$Activity_VoIPSipPeer1 agent.pm.tlsSettings.config \-tlsProtocol
2 \-tlsPublicKeyCertificate          "" \-tlsEnableTcpKeepAlive
false \-tlsReuseConnection           false \-tlsPort
"5061" \-tlsSessionRefresh           false \-enableTLS
false \-ignoreSubjectAltName         false \-tlsAuthClient
0 \-tlsPrivateKeyCertificate         "" \-tlsPassword
"" \-tlsMutual                       false \-tlsRefreshInterval
3600 \-sipScheme                     0 \-tlsTransportType
0 \-tlsDisableUdpAndTcp              true \-tlsCertificatesPath
""
```

### SEE ALSO

## TLS Cyphers

### SYNOPSIS

```
$Activity_VoIPSIPPeer1 agent.pm.tlsSettings.tlsCyphers.appendItem \  
-option value
```

### DESCRIPTION

The `tlsCyphers` object configures a list of cyphers supported by the `VoIPSipPeer` activity. Cyphers are added to the list using the `appendItem` command.

### SUBCOMMANDS

None.

### OPTIONS

`id`

The TLS cypher list Id.

`enabled`

If configured `true`, the use of the given cipher is advertised (default = `false`).

`name`

The cypher name.

### EXAMPLE

```
$Activity_VoIPSipPeer1 agent.pm.tlsSettings.tlsCyphers.clear
```

```
$Activity_VoIPSipPeer1 agent.pm.tlsSettings.tlsCyphers.appendItem \-id  
"TlsCyphers" \-enabled true \-name  
"AES128-SHA"
```

### SEE ALSO



## Custom Parameters

VoIP SIP Peer CustomParameters.

### SYNOPSIS

```
$Activity_VoIPSIPPeer1 customParameters.config \
-option value
```

### DESCRIPTION

CustomParameters configures the settings for the BHCA objective for VoIP SIP Peer activities. This options in this object correspond to the controls on the Custom Parameters tab for a NetTraffic/ActivityLink in the Timeline and Objective branch of the Test Configuration tree in the GUI.

**Note:** The CustomParameters class has to be configured alongside the CustomActivityLinkSettings class that implements the same functionality.

### SUBCOMMANDS

None.

### OPTIONS

bhcaObjectiveValue

The BHCA test objective value. Default="80000".

bhcaType

Determines how the BHCA objective will be met: by specifying the talk time or the number of channels.

Value	Usage
0 (default)	BHCA will be met by specifying the talk time. Specify the talk time in <code>talkTime</code> .
1	BHCA will be met by specifying the number of channels. Specify the number of channels in <code>channelsNo</code> .

talkTime

If `bhcaType` is 0, this option specifies the Talk Time that will be used to attain the BHCA test objective. Default="40000".

channelsNo

If `bhcaType` is 1, this option specifies the number of channels that will be used to attain the BHCA test objective. Default="100".

callSetupTime

Estimated call setup time. Default="500".

callTeardownTime

Estimated call teardown time. Default="500".

interCallDuration

Inter-call duration. Default="4000".

cpsObjectiveValue

The CPS test objective value.

cpsType

Determines how the CPS objective will be met: by specifying the talk time or the number of channels.

Value	Usage
0 (default)	CPS objective will be met by specifying the talk time. Based on the the talk time value specified in <code>talkTime</code> , the <code>cpsChannelsNo</code> value is computed.
1	CPS objective will be met by specifying the number of channels. Based on the the channels number value specified in <code>cpsChannelsNo</code> , the <code>talkTime</code> value is computed.

cpsTalkTime

If `cpsType` is 0, this option specifies the Talk Time that will be used to attain the CPS test objective. Default="40000".

cpsChannelsNo

If `bhcaType` is 1, this option specifies the number of channels that will be used to attain the CPS test objective. Default="100".

cpsOverheadTime

Indicates the duration of all other actions on the channel except the talk time and minimum inter-call duration.

cpsInterCallDuration

The minimum time interval between the end of a call on a Voice channel and the start of a new call on the same voice channel.

### EXAMPLE

```
$Activity_Make_Call customParameters.config \-talkTime
40000 \-cpsObjectiveValue           100 \-cpsType
0 \-cpsInterCallDuration            2000 \-channelsNo
100 \-cpsTalkTime                   750 \-cpsOverheadTime
1500 \-cpsChannelsNo                425 \-bhcaType
```

0	\-callTeardownTime	500	\-interCallDuration
4000	\-bhcaObjectiveValue	100	\-callSetupTime
500			

**SEE ALSO**

## Advanced Settings

Configures a VoIPSIP Cloud Peer activity that is associated with the VoIPSIP Peer.

### SYNOPSIS

```
$Activity_VoIPSIPPeer1 agent.pm.advancedSettings.config \  
-option value
```

### DESCRIPTION

Advanced Settings configure the use of a specified VoIPSIP Cloud Peer conjointly with the SIP Peer.

The SIP Proxy servers emulated by the VoIPSIP Cloud Peer can be configured to add `Via` and `Record-Route` message headers to SIP messages traversing them.

### SUBCOMMANDS

None.

### OPTIONS

`useCloud`

If `true`, this option enables use of a VoIPSIP cloud with the VoIPSIP Peer.

`false` = disabled (default)

`true` = enabled

`ovrCloudRules`

If configured `true`, default dispatching rules are being overridden.

`cloud`

Specifies the SIP cloud to use.

### EXAMPLE

```
$Activity_VoIPSipPeer1 agent.pm.advancedSettings.config \-useCloud  
true \-ovrCloudRules false \-cloud  
"VoIPSipCloud1"
```

### SEE ALSO

[Cloud Servers](#)

## Cloud Servers

Configures a list of SIP Proxy Servers emulated by a VoIPSIP Loud Peer.

### SYNOPSIS

```
$Activity_VoIPSIPPeer1 agent.pm.cloudServers.appendItem \
-option value
```

### DESCRIPTION

This object configures a list of SIP Proxy Servers emulated by a VoIPSIP Cloud Peer activity. SIP proxies are added to the list using the `appendItem` command.

**Note:** The `CloudServers` class has to be configured alongside the `SipServerList` class of a VoIP SIP Cloud Peer that implements the same functionality.

### SUBCOMMANDS

None.

### OPTIONS

`id`

The cloud server's list ID.

`firstIp`

The first IP address in the network range associated with the SIP Proxy server. This is the SIP Proxy server that is located at the cloud boundary.

`name`

The server name (default `sip_server#1` and subsequent strings).

`rangeType`

The range type, which can be `Virtual IP` and `IP`.

`ipAddr`

The starting IP address of the associated network range.

`netMask`

The network mask.

`ipStep`

The increment step of the starting IP address (default "0.0.0.1").

`attachedInfo`

An extra string associated with the proxy, such as a domain name (default = sip-test.my-domain.-com).

ipCount

The number of hosts (default = 1).

port

The SIP port (default = 5060).

ipType

The IP addressing type, IPv4 or IPv6.

### EXAMPLE

```
$Activity_VoIPSipPeer1 agent.pm.cloudServers.clear
```

```
$Activity_VoIPSipPeer1 agent.pm.cloudServers.appendItem \  
-id"CloudServer" \  
-firstIp"172.20.13.1" \  
-name"sip_server#1" \  
-rangeType"IP" \  
-ipAddr"Network Range 2 in Network1 (172.20.13.1+1)" \  
-ipStep"0.0.0.1" \  
-attachedInfo"sip-test.my-domain.com" \  
-netMask"255.254.0.0" \  
-ipCount"1" \  
-port5060 \  
-ipType"IPv4"
```

### SEE ALSO

## Server Rules

Configures a list of rules associated with each emulated SIP Proxy server in the VoIPSIP Cloud Peer.

### SYNOPSIS

```
$Activity_VoIPSIPPeer1 agent.pm.advancedSettings.serverRules.appendItem \
-option value
```

### DESCRIPTION

This object configures a rules list. For each SIP server in the cloud, its associated rule specifies if a `Via` or a `Record-Route` header are added to SIP messages traversing the server. Rules are added to the list using the `appendItem` command.

### SUBCOMMANDS

None.

### OPTIONS

`id`

The server rules list ID.

`recordRoute`

If `true`, a SIP Record-Route message header is added to SIP messages (default = `true`).

`via`

If `true`, a SIP Record-Route message header is added to SIP messages (default = `true`).

`name`

The name of the SIP Proxy server (default = `sip_server#<n>`).

### EXAMPLE

```
$Activity_VoIPSipPeer1 agent.pm.advancedSettings.serverRules.clear
```

```
$Activity_VoIPSipPeer1 agent.pm.advancedSettings.serverRules. \
appendItem \-id "ServerRule" \-recordRoute
true \-via true \-name
"sip_server#1"
```

### SEE ALSO

## Cloud Rules

Configures a list of dispatching rules that override the default VoIP SIP Cloud rules.

### SYNOPSIS

```
$Activity_VoIPSIPPeer1 agent.pm.cloudRules.rulesList.appendItem \  
-option value
```

### DESCRIPTION

A new dispatching rule is added to the `rulesList` of the `cloudRules` object using the `appendItem` sub-command from the `ixConfigSequenceContainer` command.

### SUBCOMMANDS

None.

### OPTIONS

`id`

The cloud rules list Id.

`when`

Specifies the SIP message that is processed for extracting a rule.

`where`

- Extracts the variable from the request line, or from parts of it, as follows:
- Entire First Line
- Request Line - Method
- Request Line - Request-URI
- Request Line - Request-URI - Phone
- Request Line - SIP Version

`refine`

Specifies if further processing is applied or not:

- N/A: No further processing is applied
- Refined: Further processing is applied, as defined by a `RuleData` object.

`formula`

A formula that is defined using the same syntax as a sequence generator expression. Form the extracted string matched against the dispatching formula, the message is dispatched to a specific SIP channel.

### EXAMPLE

```
$Activity_VoIPSipPeer1 agent.pm.cloudRules.rulesList.clear
```



```
$Activity_VoIPSipPeer1 agent.pm.cloudRules.rulesList.appendItem \-id  
"CloudRule" \-where           "Request Line - Request-URI -  
Phone" \-when                 "INVITE" \-refine  
"N/A" \-formula               "160\[00000000-\]"
```

**SEE ALSO**

[RuleData](#)

## RuleData

Configures the processing operations applied to incoming message for extracting a dispatching rule.

### SYNOPSIS

```
$Activity_VoIPSipPeer agent.pm.cloudRules.rulesList(0).ruleData.config \  
-option value
```

### DESCRIPTION

A `RuleData` object defining further processing that is applied to a string after it is extracted from a SIP message. This object corresponds to the Edit Cloud Rule GUI in the application.

### SUBCOMMANDS

None.

### OPTIONS

`what`

Defines the extraction scope as one of the following:

- 0 = Entire SIP request
- 1 = Request line
- 2 = Header
- 3 = SIP message body

`reqLine`

If `what` is configured to the value '1', this parameter specifies which part of the request line the string is extracted from:

- 0 = Entire First Line
- 1 = Request Line - Request-URI - Phone
- 2 = Request Line - Method
- 3 = Request Line - Request-URI
- 4 = Request Line - SIP Version

`headerType`

If `what` is configured to the value '2', this parameter specifies a header type that is being extracted (default = To).

`compactForm`

If `what` is configured to the value '2', this parameter defines the compact form of the SIP message header specified by the `headerType` parameter.

---

`occurFrom, endOccur`

If `what` is configured to the value '2', this parameter specifies between which occurrences extraction is done.

`whatExtract`

If `what` is configured to the value '2', this parameter specifies which part of the header is extracted:

- 0 = Whole header value
- 1 = Header value without parameters
- 2 = The parameter specified by `paramName`
- 3 = Phone value from URI

`extractHeaderName`

When the `whatExtract` parameter is configured to the value '0', if this option is configured `true`, the header name is also extracted.

`paramName`

When the `whatExtract` parameter is configured to the value '2', this option extracts the value of the named parameter.

`revHeaderOrder`

When configured `true`, this option to `true` processes the occurrences in reverse order, starting from the last up to the first.

`keepHeaderCrlf`

When configured `true`, the last Carriage Return/Line Feed character extracted into the variable is kept.

**Note:** The parameters above correspond to Step 2 in the dispatching rules definition window of the IxLoad GUI.

`usePosition`

Specifies the mode in which an extracted substring is delimited:

- 0 = The substring is marked by delimiters.
- 1 = The substring is marked by position.

`beginAfter`

If this parameter is configured `true`, a substring is delimited by the `afterStr` and `afterOccur` parameters.

This parameter is relevant when `usePosition` is configured to the value '0'.

`afterStr, afterOccur`

The substring start is indicated by these parameters.

`endBefore`

If this parameter is configured `true`, a substring is delimited by the `endStr` and `endOccur` parameters.

`endStr`, `endOccur`

The substring end is indicated by these parameters.

`positionFrom`, `positionTo`

If `usePosition` is configured to the value `'1'`, these parameters specify the delimiting positions for position-based substring extraction.

`formula`

Specifies a formula that is defined using the same syntax as a sequence generator expression. The extracted string matched against the dispatching formula and the message is dispatched to a specific SIP channel.

**Note:** The parameters above correspond to Step 3 in the dispatching rules definition window of the IxLoad GUI.

### EXAMPLE

```
$Activity_VoIPSipPeer1 agent.pm.cloudRules.rulesList.appendItem \-id
"CloudRule" \-where           "Request Line - Request-URI -
Phone" \-when                 "INVITE" \-refine
"Refined" \-formula           "160\[00000000-\]"
```

```
$Activity_VoIPSipPeer1 agent.pm.cloudRules.rulesList(0).ruleData. \ config \
-positionFrom                "1" \-what
1 \-endBefore                 true \-extractHeaderName
false \-headerType           "To" \-whatExtract
3 \-occurFrom                 "1" \-formula
"160\[00000000-\]" \-endStr   ">" \-usePosition
0 \-endOccur                  "last" \-positionTo
"last" \-reqLine              1 \-keepHeaderCrlf
false \-compactForm          "t" \-paramName
"" \-afterOccur              "1" \-beginAfter
true \-afterStr               "<" \-occurTo
"1" \-revHeaderOrder         false
```

### SEE ALSO

## VoIP Skinny Peer

The IxLoad VoIP Skinny Peer Tcl API consists of a VoIP Skinny Peer agent, with separate APIs for configuring each major aspect of the agent's functionality.

## Limitations

The following restrictions and limitations of the VoIPSkinny Peer API exist:

- The PhoneBook and other related classes, such as PhoneBookEntry, can not be edited from the Tcl API.
- Individual VoIP Skinny script functions can not be added and edited from the Tcl API. Instead, you must add and configure the commands in the Scenario Editor, save the test scenario file, then pass it as an argument to the `ScenarioSettings` API class.
- Implementation of the BHCA objective features relies on two classes, `CustomParameters` and `CustomActivityLinkSettings` that have to be configured using the same parameters.

## VoIP Skinny Peer API Commands

The IxLoad VoIP Skinny Peer API commands are organized as shown in the figure below.

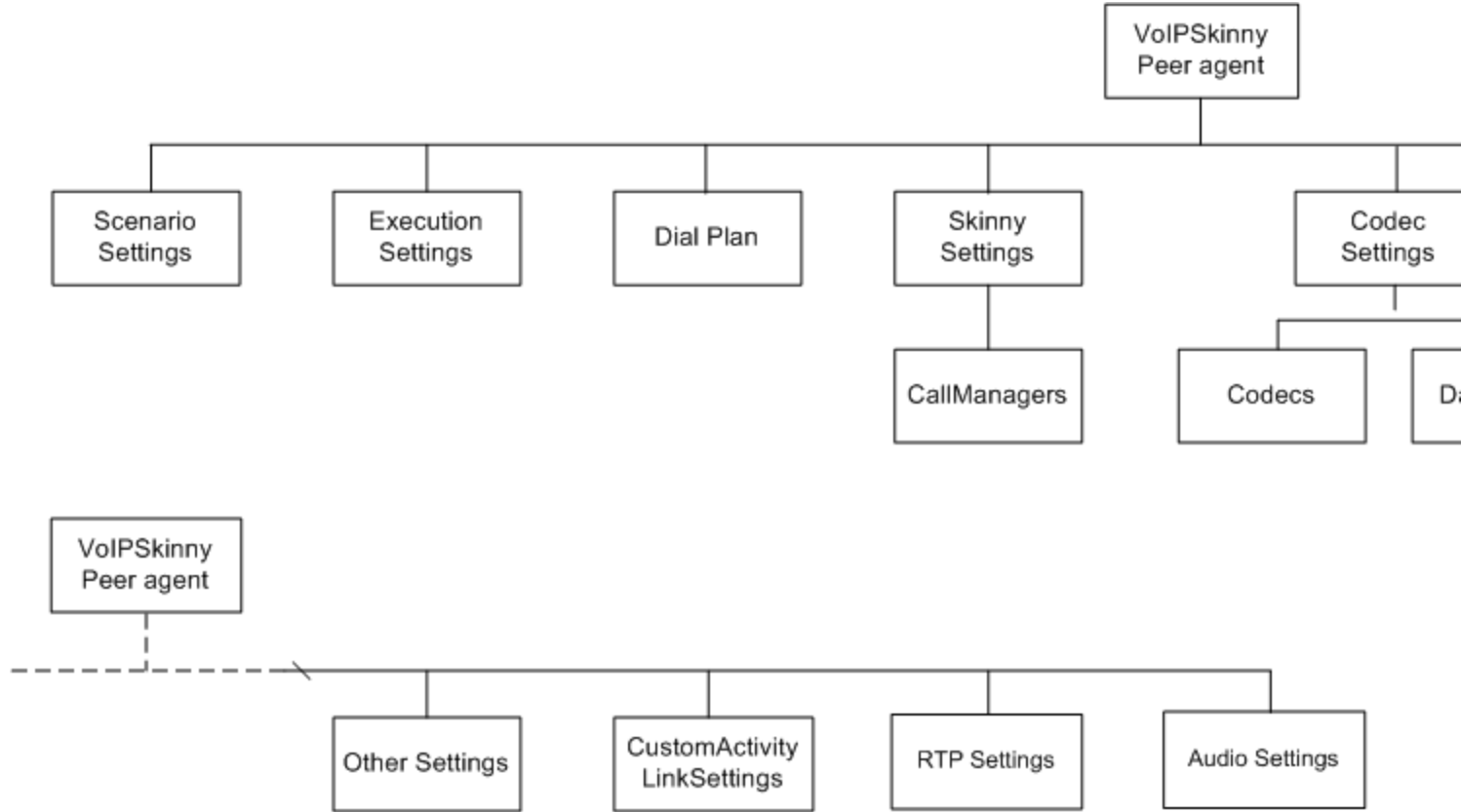

## VoIP Skinny API Objects

The table below lists the VoIP Skinny Peer API objects.

Object	Description
VoIP Skinny Peer Agent	Top-level object defining the VoIP Skinny Peer activity.
Scenario Settings	Selects the Test Scenario file; corresponds to the Scenario Settings GUI tab.
Codec Settings	List of Data Codecs and Codecs objects.
Data Codecs	Data codec with parameters.
Codecs	Audio codec with parameters.
Skinny Settings	VoIP Skinny Peer Skinny parameters; corresponds to the Skinny Settings GUI tab.
CallManager	CallManager object with parameters.
Execution Settings	Run-time test configuration; corresponds to the Execution Settings GUI tab.
Dial Plan	Configures the registration names, phone numbers, and source, destination, and transfer addresses for the channels/phones; corresponds to the Dial Plan GUI tab.
RTP Settings	RTP transport configuration; corresponds to the RTP Settings GUI tab.
Audio Settings	Audio settings; corresponds to the Audio GUI tab.
Other Settings	VoIP Skinny Peer miscellaneous parameters; corresponds to the Other Settings GUI tab.
Custom Activity Link Settings, CustomParameters	BHCA objective configuration; corresponds to the Custom Parameters GUI tab.

## VoIP Skinny Peer Agent

VoIP Skinny Peer Agent

### SYNOPSIS

```
set Activity_VoIPSkinnyPeer1 \  
[$ClientNetwork1 activityList.appendItem \  
-protocolAndType"VoIP Skinny Peer" ]
```

### DESCRIPTION

A VoIP Skinny Peer agent is added to the `agentList` option of the `config` object using the `appendItem` subcommand from the `ixConfigSequenceContainer` command. Other `ixConfigSequenceContainer` subcommands may be used to modify the `agentList`. See the following example:

```
set Activity_VoIPSkinnyPeer2 [$skinny_client_ClientNetwork1 \  
activityList.appendItem \-protocolAndType "VoIP Skinny Peer" \  
] $Activity_VoIPSkinnyPeer2 config \-enable true \  
name "VoIPSkinnyPeer2" \-enableConstraint \  
false \-userObjectiveValue 1 \-constraintValue \  
100 \-userObjectiveType "channels" \-timeline \  
$Timeline3 \  

```

```
$Activity_VoIPSkinnyPeer2 agent.config \-enable \  
true \-name "VoIPSkinnyPeer2"
```

Each member of the list, however may be separately addressed and modified using the `ixConfig` subcommands. For example, the first agent uses an index of 0 and its name may be modified by:

```
$Activity_VoIPSkinnyPeer1 agent(0).config -name "VoIP Skinny Peer new"
```

### SUBCOMMANDS

None.

### OPTIONS

`enable`

Enables the use of this agent. (Default = true).

`name`

The name associated with this object, which must be set at object creation time.

### STATISTICS

The table below lists the statistics published by this object.



	<b>Note:</b> Statistics from this category are not displayed in any of the pre-defined views, but can be assigned to custom statistics views.		
Statistic	Description	Per Channel/Global	
<b>VoIPSkinny Channels</b>			
Successful Channels	The per polling interval number of COMPLETED channels. A channel is COMPLETED if all the channel loops were COMPLETED.	Global	
Warning Channels	The per polling interval number of WARNING channels. A channel is WARNING if all the channel loops were COMPLETED or WARNING and at least one loop had a WARNING result.	Global	
Failed Channels	The per polling interval number of FAILED channels. A channel is FAILED if all the loops of the channel were COMPLETED, WARNING, or FAILED and at least one loop was FAILED.	Global	
Aborted Channels	The per polling interval number of ABORTED channels. A channel is ABORTED if all the channel loops of the channel were COMPLETED, WARNING, FAILED, or ABORTED and at least one loop was ABORTED.	Global	
Active Channels	The per polling interval number of active channels. Active channels are the channels executing a scenario channel functions flow.	Global	
Total Channels	The per polling interval total number of channels, a sum of active and non-active channels.	Global	
<b>VoIPSkinny Loops</b>			
Successful Channel Loops	The cumulative count of COMPLETED channel loops. A channel loop is COMPLETED if all executed script functions in the corresponding scenario channel produced SKIPPED or COMPLETED function results.	Global	
Warning Channel Loops	The cumulative count of WARNING channel loops. A channel loop has a WARNING result if all executed script functions in the corresponding scenario channel produced SKIPPED, COMPLETED, or WARNING function results and at least one script function had a WARNING result.	Global	

Failed Channel Loops	The cumulative count of FAILED channel loops. A channel loop is FAILED if all executed script functions in the corresponding scenario channel produced SKIPPED, COMPLETED, WARNING, or FAILED function results and at least one script function had a FAILED result.	Global
Aborted Channel Loops	The cumulative count of ABORTED channel loops. A channel loop is FAILED if all executed script functions in the corresponding scenario channel produced SKIPPED, COMPLETED, WARNING, FAILED, or ABORTED function results and at least one script function had an ABORTED result.	Global
Total Channel Loops	The cumulative count of total executed loops.	Global
Inter Loop Duration (Avg) (ms)	The average time gap between loops.	Global
<b>VoIPSkinny Calls</b>		
Attempted Calls	The number of originated calls - not necessarily answered or connected. This statistic is updated whenever the <i>skNewCall</i> , <i>SkRedial</i> , or <i>SkMeetMeConfrn</i> softkey is sent. It is also incremented when a transfer or a conference is initiated, i.e. a <i>SkTransfer</i> or a <i>SkConfrn</i> softkey is sent for the first time.	Global
Connected Calls	The number of calls successfully connected from the originator point of view. This statistic is incremented whenever the originating side receives a <i>StartMediaTransmission</i> message.	Global
Received Calls	The number of received calls, not necessarily answered. This statistic is incremented whenever the <i>CallState TsRingIn</i> or the <i>CallState TsWaitCalling</i> message is received by the call terminating side.	Global
Answered Calls	The number of calls received, successfully answered and connected. This statistic is incremented whenever the receiving side receives a <i>StartMediaTransmission</i> message.	Global
Transferred Calls	The number of transferred calls. This statistic is updated whenever the <i>CallState TsOnHook</i> message is received, after the second <i>SkTransfer</i> softkey was sent, to complete the transfer.	Global

Active Calls	Number of active calls at one time. This statistic is incremented when the <i>StartMediaTransmission</i> message is received, and is decremented when the <i>CallState TsOnHook</i> message is received or at the end of the loop.	Global
Busy Calls	The number of calls that were rejected with the party being busy as a cause. This statistic is incremented when the <i>CallState TsBusy</i> message is received.	Global
End Call Initiated	The number of initiated end call operations. This statistic is updated whenever the <i>skEndCall</i> softkey is sent.	Global
End Call Received	This statistic is updated whenever the <i>CallState TsOnHook</i> message is received, without the <i>skEndCall</i> softkey being previously sent.	Global
End Calls Completed	This statistic is updated whenever the <i>CallState TsOnHook</i> message is received after having sent a <i>SkEndCall</i> softkey.	Global
Answered Calls TX	The number of acknowledged calls (answered), but not necessarily connected. This statistic is incremented when the <i>CallState TsConnected</i> message is received by originating side.	Global
Attempted Answered Calls RX	The number of calls received and answered, but not necessarily completed. This statistic is incremented whenever the <i>SkAnswer</i> softkey event is sent by the receiving side.	Global
<b>VoIPSkinny Call Rates</b>		

<p>Attempted Calls /s,          Connected Calls /s,          Received Calls /sec,          Answered Calls /s,          Rejected Calls /s,          Calls with Authentication Required /s,          Transferred Calls /s,          Busy Calls /s,          Redirected Calls /s</p>	<p>The per polling interval rates corresponding to some of the previous VoIPSkinny Calls statistics.</p>	Global
<b>VoIPSkinny Call Times</b>		
<p>Call Setup Time TX Avg (ms)</p>	<p>The time it takes to setup a call and receive a call acceptance acknowledgement from the remote endpoint, including the post-dial delay and computed as the time between the <i>SkNewCall</i> and the <i>StartMediaTransmission</i> events.</p>	Global
<p>Call Setup Time RX Avg (ms)</p>	<p>The time from receiving the request for the call until receiving the final caller acknowledgment that the call setup has been successfully completed, computed as time between the <i>CallState TsRingIn</i> and the <i>StartMedia Transmission</i> events.</p>	Global
<p>Talk Time (Avg)</p>	<p>The active conversational between the <i>StartMediaTransmission</i> message until the <i>CloseReceiveChannel</i> message.</p>	Global
<p>End Call Time (Avg)</p>	<p>The time between the sending the <i>SkEndCall</i> softkey and receiving the <i>CallState TsOnHook</i> message.</p>	Global
<p>Total Call Duration (Avg)</p>	<p>The total call duration comprising the call setup, talk, and end call times.</p>	Global
<b>VoIPSkinny Delays</b>		

Post Dial Delay (Avg) [ms]	The per polling interval time elapsed between sending of the last dialed number digit and receiving of a <i>CallStateMessage TsRingOut</i> , <i>TsCongestion</i> , <i>TsBusy</i> , or <i>TsInvalidNumber</i> message.	Global
Media Delay TX (Avg) [ms], Media Delay TX (Max) [ms], Media Delay TX (Min) [ms]	The per polling interval average/min/max media delay, including both the call setup delay and the post dial delay, is delimited in time by the sending of the last dialed digit and the receiving of the first RTP packet at the call initiating endpoint.	Global
Media Delay RX (Avg) [ms], Media Delay RX (Max) [ms], Media Delay RX (Min) [ms]	The per polling interval average/min/max time elapsed between receiving the <i>CallState TsRingIn</i> message and receiving the first media packet. The media delay includes both the call setup delay and post-pickup delay.	Global
Post-Pickup Delay (Avg) [ms], Post-Pickup Delay (Max) [ms], Post-Pickup Delay (Min) [ms]	The per polling interval average/min/max time elapsed between sending the <i>SoftKeyEventMessage</i> ( <i>SoftKeyEvent = Answer</i> ) and receiving the first media packet.	Global
Dial Tone Delay (Avg) [ms]	The per polling interval time elapsed between sending the <i>OffHook</i> message or the <i>NewCall</i> softkey and receiving the <i>StationStartToneMessage (DtDialTone)</i> .	Global
Busy Tone Delay (Avg) [ms]	The per polling interval time elapsed between sending the <i>NewCall</i> softkey included in the <i>OffHook</i> message and receiving the <i>StationStartToneMessage (DtLineBusyTone)</i> .	Global
<b>VoIPSkinny Registrations</b>		

Attempted Registrations	The cumulative count of attempted registrations, incremented when a phone is starting registration with the primary CCM. If the phone is already registered, the statistic is not incremented. <b>Note:</b> If a problem occurs with the primary CCM, the phone tries to re-register with the second CCM and the statistic is incremented.	Global
Successful Registrations	The cumulative count of successful registrations, incremented when a registration completes, that is all the registration sequence messages have been sent and replies for them have been received from the primary CCM.	Global
Failed Registrations	The cumulative count of failed registrations, incremented whenever the CCM replies with the <i>RegisterReject</i> message, the timeout for the registration function expires, or in case of connection failure.	Global
Attempted De-Registrations	The cumulative count of attempted de-registrations, incremented when a phone is starting de-registration with the primary CCM by sending the <i>Unregister</i> message.	Global
Successful De-Registrations	The cumulative count of successful de-registrations, incremented when the phone receives the reply <i>UnregisterAck</i> message from the primary CCM.	Global
Failed De-Registrations	The cumulative count of failed de-registrations, incremented when the timeout for the Skinny Unregister Client script function expires.	Global
Registration Time (Avg) [ms]	The time it takes for the registration function to complete, including the time for the establishment of the primary and secondary CCM connections, the time spent to send all the registration sequence messages and to receive the replies from the primary CCM.	Global
DeRegistration Time (Avg) [ms]	The time it takes the phone to send the Unregister message and to wait for the reply <i>UnregisterAck</i> message from the primary CCM.	Global
<b>VoIPSkinny Registration Rates</b>		
Attempted Registrations /s	The per polling interval attempted registration rate.	Global

Successful Registrations /s	The per polling interval successful registration rate.	Global
Attempted De-Registrations /s	The per polling interval attempted de-registration rate.	Global
Successful De-Registrations /s	The per polling interval successful de-registration rate.	Global
<b>VoIPSkinny Errors</b>		
Transport Errors	The number of Skinny transport errors, occurring when a Skinny message cannot be sent due to a socket error.	Global
Trigger Errors	The number of trigger errors.	Global
RTP Errors	The total number of RTP related errors, incremented when any RTP script function is failing or exiting on the Warning or Timeout outputs.	Global
Timeout Errors	The number of script functions timeout errors.	Global
Internal Errors	The total number of internal errors.	Global
<b>VoIPSkinny Busy Hour Call Measurements</b>		
BHCA	The Busy Hour Call Attempts rate that represents the number of calls initiated in one hour.	Global
BHCC	The Busy Hour Call Completions rate that represents the number of calls initiated and connected in one hour.	Global
<b>VoIPSkinny Other</b>		
Payload Bytes Received, Payload Bytes Received/s	The inbound RTP payload bytes number, inbound RTP payload bytes rate.	Both
Triggers Sent, Triggers Sent /s	The number of triggers sent, the rate of triggers sent.	Global
Triggers Received, Triggers Received /s	The number of triggers received, the rate of triggers received	Global

Triggers Bytes Sent, Triggers Bytes Sent /s	The number of trigger bytes sent, the rate of trigger bytes sent.	Global
Triggers Bytes Received, Triggers Bytes Received /s	The number of trigger bytes received, the rate of trigger bytes received.	Global

Table 29-1. VoIPSkinnyPeer Statistics

Statistic	Description	Per Channel/Global
<b>VoIPSkinny Channels</b>		
Successful Channels	The per polling interval number of COMPLETED channels. A channel is COMPLETED if all the channel loops were COMPLETED.	Global
Warning Channels	The per polling interval number of WARNING channels. A channel is WARNING if all the channel loops were COMPLETED or WARNING and at least one loop had a WARNING result.	Global
Failed Channels	The per polling interval number of FAILED channels. A channel is FAILED if all the loops of the channel were COMPLETED, WARNING, or FAILED and at least one loop was FAILED.	Global
Aborted Channels	The per polling interval number of ABORTED channels. A channel is ABORTED if all the channel loops of the channel were COMPLETED, WARNING, FAILED, or ABORTED and at least one loop was ABORTED.	Global
Active Channels	The per polling interval number of active channels. Active channels are the channels executing a scenario channel functions flow.	Global
Total Channels	The per polling interval total number of channels, a sum of active and non-active channels.	Global
<b>VoIPSkinny Loops</b>		



Successful Channel Loops	The cumulative count of COMPLETED channel loops. A channel loop is COMPLETED if all executed script functions in the corresponding scenario channel produced SKIPPED or COMPLETED function results.	Global
Warning Channel Loops	The cumulative count of WARNING channel loops. A channel loop has a WARNING result if all executed script functions in the corresponding scenario channel produced SKIPPED, COMPLETED, or WARNING function results and at least one script function had a WARNING result.	Global
Failed Channel Loops	The cumulative count of FAILED channel loops. A channel loop is FAILED if all executed script functions in the corresponding scenario channel produced SKIPPED, COMPLETED, WARNING, or FAILED function results and at least one script function had a FAILED result.	Global
Aborted Channel Loops	The cumulative count of ABORTED channel loops. A channel loop is FAILED if all executed script functions in the corresponding scenario channel produced SKIPPED, COMPLETED, WARNING, FAILED, or ABORTED function results and at least one script function had an ABORTED result.	Global
Total Channel Loops	The cumulative count of total executed loops.	Global
Inter Loop Duration (Avg) (ms)	The average time gap between loops.	Global
<b>VoIPSkinny Calls</b>		
Attempted Calls	The number of originated calls - not necessarily answered or connected. This statistic is updated whenever the <code>skNewCall</code> , <code>SkRedial</code> , or <code>SkMeetMeConfrn</code> softkey is sent. It is also incremented when a transfer or a conference is initiated, i.e. a <code>SkTransfer</code> or a <code>SkConfrn</code> softkey is sent for the first time.	Global
Connected Calls	The number of calls successfully connected from the originator point of view. This statistic is incremented whenever the originating side receives a <code>StartMediaTransmission</code> message.	Global

Received Calls	The number of received calls, not necessarily answered. This statistic is incremented whenever the <code>CallState TsRingIn</code> or the <code>CallState TsWaitCalling</code> message is received by the call terminating side.	Global
Answered Calls	The number of calls received, successfully answered and connected. This statistic is incremented whenever the receiving side receives a <code>StartMediaTransmission</code> message.	Global
Transferred Calls	The number of transferred calls. This statistic is updated whenever the <code>CallState TsOnHook</code> message is received, after the second <code>SkTransfer</code> softkey was sent, to complete the transfer.	Global
Active Calls	Number of active calls at one time. This statistic is incremented when the <code>StartMediaTransmission</code> message is received, and is decremented when the <code>CallState TsOnHook</code> message is received or at the end of the loop.	Global
Busy Calls	The number of calls that were rejected with the party being busy as a cause. This statistic is incremented when the <code>CallState TsBusy</code> message is received.	Global
End Call Initiated	The number of initiated end call operations. This statistic is updated whenever the <code>skEndCall</code> softkey is sent.	Global
End Call Received	This statistic is updated whenever the <code>CallState TsOnHook</code> message is received, without the <code>skEndCall</code> softkey being previously sent.	Global
End Calls Completed	This statistic is updated whenever the <code>CallState TsOnHook</code> message is received after having sent a <code>SkEndCall</code> softkey.	Global
Answered Calls TX	The number of acknowledged calls (answered), but not necessarily connected. This statistic is incremented when the <code>CallState TsConnected</code> message is received by originating side.	Global
Attempted Answered Calls RX	The number of calls received and answered, but not necessarily completed. This statistic is incremented whenever the <code>SkAnswer</code> softkey event is sent by the receiving side.	Global
<b>VoIPSkinny Call Rates</b>		

<p>Attempted Calls /s,  Connected Calls /s,  Received Calls /sec,  Answered Calls /s,  Rejected Calls /s,  Calls with Authentication Required /s,  Transferred Calls /s,  Busy Calls /s,  Redirected Calls /s</p>	<p>The per polling interval rates corresponding to some of the previous VoIPSkinny Calls statistics.</p>	Global
<b>VoIPSkinny Call Times</b>		
<p>Call Setup Time TX Avg (ms)</p>	<p>The time it takes to setup a call and receive a call acceptance acknowledgement from the remote endpoint, including the post-dial delay and computed as the time between the <code>SkNewCall</code> and the <code>StartMediaTransmission</code> events.</p>	Global
<p>Call Setup Time RX Avg (ms)</p>	<p>The time from receiving the request for the call until receiving the final caller acknowledgment that the call setup has been successfully completed, computed as time between the <code>CallState TsRingIn</code> and the <code>StartMediaTransmission</code> events.</p>	Global
<p>Talk Time (Avg )</p>	<p>The active conversational between the <code>StartMediaTransmission</code> message until the <code>CloseReceiveChannel</code> message.</p>	Global
<p>End Call Time (Avg)</p>	<p>The time between the sending the <code>SkEndCall</code> softkey and receiving the <code>CallState TsOnHook</code> message.</p>	Global
<p>Total Call Duration (Avg)</p>	<p>The total call duration comprising the call setup, talk, and end call times.</p>	Global
<b>VoIPSkinny Delays</b>		

Post Dial Delay (Avg) [ms]	The per polling interval time elapsed between sending of the last dialed number digit and receiving of a <code>CallStateMessage</code> <code>TsRingOut</code> , <code>TsCongestion</code> , <code>TsBusy</code> , or <code>TsInvalidNumber</code> message.	Global
Media Delay TX (Avg) [ms], Media Delay TX (Max) [ms], Media Delay TX (Min) [ms]	The per polling interval average/min/max media delay, including both the call setup delay and the post dial delay, is delimited in time by the sending of the last dialed digit and the receiving of the first RTP packet at the call initiating endpoint.	Global
Media Delay RX (Avg) [ms], Media Delay RX (Max) [ms], Media Delay RX (Min) [ms]	The per polling interval average/min/max time elapsed between receiving the <code>CallState</code> <code>TsRingIn</code> message and receiving the first media packet.  The media delay includes both the call setup delay and post-pickup delay.	Global
Post-Pickup Delay (Avg) [ms], Post-Pickup Delay (Max) [ms], Post-Pickup Delay (Min) [ms]	The per polling interval average/min/max time elapsed between sending the <code>SoftKeyEventMessage</code> ( <code>SoftKeyEvent = Answer</code> ) and receiving the first media packet.	Global
Dial Tone Delay (Avg) [ms]	The per polling interval time elapsed between sending the <code>OffHook</code> message or the <code>NewCall</code> softkey and receiving the <code>StationStartToneMessage</code> ( <code>DtDialTone</code> ).	Global
Busy Tone Delay (Avg) [ms]	The per polling interval time elapsed between sending the <code>NewCall</code> softkey included in the <code>OffHook</code> message and receiving the <code>StationStartToneMessage</code> ( <code>DtLineBusyTone</code> ).	Global
<b>VoIPSkinny Registrations</b>		

Attempted Registrations	The cumulative count of attempted registrations, incremented when a phone is starting registration with the primary CCM. If the phone is already registered, the statistic is not incremented. <b>Note:</b> If a problem occurs with the primary CCM, the phone tries to re-register with the second CCM and the statistic is incremented.	Global
Successful Registrations	The cumulative count of successful registrations, incremented when a registration completes, that is all the registration sequence messages have been sent and replies for them have been received from the primary CCM.	Global
Failed Registrations	The cumulative count of failed registrations, incremented whenever the CCM replies with the <code>RegisterReject</code> message, the timeout for the registration function expires, or in case of connection failure.	Global
Attempted De-Registrations	The cumulative count of attempted de-registrations, incremented when a phone is starting de-registration with the primary CCM by sending the <code>Unregister</code> message.	Global
Successful De-Registrations	The cumulative count of successful deregistrations, incremented when the phone receives the reply <code>UnregisterAck</code> message from the primary CCM.	Global
Failed De-Registrations	The cumulative count of failed deregistrations, incremented when the timeout for the Skinny <code>Unregister</code> Client script function expires.	Global
Registration Time (Avg) [ms]	The time it takes for the registration function to complete, including the time for the establishment of the primary and secondary CCM connections, the time spent to send all the registration sequence messages and to receive the replies from the primary CCM.	Global
DeRegistration Time (Avg) [ms]	The time it takes the phone to send the <code>Unregister</code> message and to wait for the reply <code>UnregisterAck</code> message from the primary CCM.	Global
<b>VoIPSkinny Registration Rates</b>		
Attempted Registrations /s	The per polling interval attempted registration rate.	Global

Successful Registrations /s	The per polling interval successful registration rate.	Global
Attempted De-Registrations /s	The per polling interval attempted de-registration rate.	Global
Successful De-Registrations /s	The per polling interval successful de-registration rate.	Global
<b>VoIPSkinny Errors</b>		
Transport Errors	The number of Skinny transport errors, occurring when a Skinny message cannot be sent due to a socket error.	Global
Trigger Errors	The number of trigger errors.	Global
RTP Errors	The total number of RTP related errors, incremented when any RTP script function is failing or exiting on the Warning or Timeout outputs.	Global
Timeout Errors	The number of script functions timeout errors.	Global
Internal Errors	The total number of internal errors.	Global
<b>VoIPSkinny Busy Hour Call Measurements</b>		
BHCA	The Busy Hour Call Attempts rate that represents the number of calls initiated in one hour.	Global
BHCC	The Busy Hour Call Completions rate that represents the number of calls initiated and connected in one hour.	Global
<b>VoIPSkinny Other</b>		
Payload Bytes Received, Payload Bytes Received/s	The inbound RTP payload bytes number, inbound RTP payload bytes rate.	Both
Triggers Sent, Triggers Sent /s	The number of triggers sent, the rate of triggers sent.	Global

Triggers Received, Triggers Received /s	The number of triggers received, the rate of triggers received	Global
Triggers Bytes Sent, Triggers Bytes Sent /s	The number of trigger bytes sent, the rate of trigger bytes sent.	Global
Triggers Bytes Received, Triggers Bytes Received /s	The number of trigger bytes received, the rate of trigger bytes received.	Global
<p><b>Note:</b> Statistics from this category are not displayed in any of the pre-defined views, but can be assigned to custom statistics views.</p>		

## EXAMPLE

```
set Activity_VoIPSkinnyPeer1 [$myNetTraffic activityList.appendItem \-
protocolAndType "VoIPSkinny Peer" ]
```

```
set Timeline1 [::IxLoad new ixTimeline]$Timeline1 config \-rampUpValue
1 \-rampUpType 0 \-offlineTime
0 \-rampDownTime 20 \-standbyTime
0 \-iterations 1 \-rampUpInterval
1 \-sustainTime 20 \-timelineType
0 \-name "Timeline1"
```

```
$Activity_VoIPSkinnyPeer1 config \-enable 1 \-name
"VoIPSkinnyPeer1" \-enableConstraint false \-
userObjectiveValue 100 \-constraintValue
100 \-userObjectiveType "channels" \-timeline
$Timeline1
```

```
$Activity_VoIPSkinnyPeer1 agent.config \-enable 1
\-name "VoIPSkinnyPeer1"
```

## SEE ALSO

ixConfig





---

## Scenario Settings

VoIP Skinny Peer Scenario Settings

### SYNOPSIS

```
$Activity_VoIPSkinnyPeer1 agent.pm.scenarioSettings.config \  
-option value
```

### DESCRIPTION

Scenario Settings specifies the test scenario file that will be used by the Tcl script.

### SUBCOMMANDS

None.

### OPTIONS

The options for this command are configured and read using the standard `config`, `cget`, and `getOption` subcommands defined in the `ixConfig` command.

`scenarioFile`

The full path to the test scenario file for the activity.

`activeScenarioChannel`

Test scenario channel (0-based index) that is associated with the VoIP Skinny Peer activity. Default = 0.

### EXAMPLE

```
$Activity_VoIPSkinnyPeer1 agent.pm.scenarioSettings.config \  
-scenarioFile"E:\\ScenarioTestFiles\\Skinny.tst" \  
-activeScenarioChannel0
```

### SEE ALSO

## Execution Settings

VoIP Skinny Peer Execution Settings

### SYNOPSIS

```
$Activity_VoIPSkinnyPeer1 agent.pm.executionSettings.config \  
-optionvalue
```

### DESCRIPTION

This object defines the execution settings for the VoIP Skinny Peer.

### SUBCOMMANDS

None.

### OPTIONS

The options for this command are configured and read using the standard `config`, `cget`, and `getOption` subcommands defined in the `ixConfig` command.

`loopMode`

Defines how many loops are executed for every voice channel corresponding to this activity.

Value	Description
0 (default)	Loop for the entire test duration.
1	Execute a number of loops. Specify the number of loops in <code>loopCount</code> .

`loopCount`

If `loopMode` is 1, this option defines the number of loops that the test performs. Default="1".

`loopPreDelay`

Delay before first loop (ms). Default="0", min="0" max="3600000".

`loopMidDelay`

Delay between loops (ms). Default="0" min="0" max="3600000".

`aliases`

Number of aliases (phone numbers) per channel. Default="1", min="1" max="16000".

### EXAMPLE

```
$Activity_VoIPSkinnyPeer1 agent.pm.executionSettings.config \  
-optionvalue
```

-loopMidDelay0 \

-loopCount1 \

-loopPreDelay0 \

-loopMode0 \

-aliases1

**SEE ALSO**

## Dial Plan

VoIP Skinny Peer Dial Plan

### SYNOPSIS

```
$Activity_VoIPSkinnyPeer1 agent.pm.dialPlan.config \  
-option value
```

### DESCRIPTION

The Dial Plan object configures the registration names, phone numbers, and source, destination, and transfer addresses for the channels/phones emulated by the VoIP Skinny Peer activity.

### SUBCOMMANDS

None.

### OPTIONS

The options for this command are configured and read using the standard `config`, `cget`, and `getOption` subcommands defined in the `ixConfig` command.

#### Source options

```
useSourcePhoneBook
```

Method used to select phone number.

Value	Usage
0	Use the phone number specified by pattern.
1	Use the phone number specified by Phonebook entry.

**Note:** This options appears in the generated tcl code only if the test configuration contains a reference to a Phonebook entry (`useSourcePhoneBook=1`). The generated Tcl script will run only on the machine it has been generated on and only if the corresponding Phonebook entry has not yet been deleted since the generation of the Tcl code.

```
sourcePhoneSpecified
```

If `useSourcePhoneBook` is 0, this option specifies the phone number. You can use sequence generators in this field to generate multiple phone numbers. See the sequence generator appendix. `Default-t="160[00000000-]"`.

```
sourcePhoneType
```

Type of source phone number:

0 = Specified by `sourcePhoneSpecified` as digits (default).

1 = Specified by `sourcePhoneBook` as a file name.

`sourcePhoneBook`

If `useSourcePhoneBook` is 1, this option specifies the phone book entry name. Default=`&lt;None&gt;`.

Destination options

`useDestPhoneBook`

Method used to select the phone number used to override destination phone number.

Value	Usage
0 (default)	Specify pattern.
1	Specify Phonebook entry.

**Note:** This options appears in the generated tcl code only if the test configuration contains a reference to a Phonebook entry (`useDestPhoneBook=1`). The generated Tcl script will run only on the machine it has been generated on and only if the corresponding Phonebook entry has not yet been deleted since the generation of the Tcl code.

`destPhoneSpecified`

If `useDestPhoneBook` is 0, this option specifies the phone number.

Default=`"170[00000000-]"`.

`destPhoneType`

Type of destination phone number:

0 = Specified by `destPhoneSpecified` as digits (default).

1 = Specified by `destPhoneBook` as a file name.

`destPhoneBook`

If `useDestPhoneBook` is 1, this option specifies the phone book file name.

Default=`&lt;None&gt;`.

`symDestStr`

String identifying the VoIP Skinny Peer that is the destination for traffic from this VoIP Skinny Peer.

Default=`"None"`.

`ovrDestPhone`

Enables overriding of phone number from the destination VoIP Skinny Peer.

Value	Usage
0 (default)	Disabled
1	Enabled

## Registration options

`useSourceRegBook`

Method used to select registration names.

Value	Usage
0	Use the phone number specified by pattern.
1	Use the phone number specified by Phonebook entry.

**Note:** This options appears in the generated tcl code only if the test configuration contains a reference to a Phonebook entry (`useSourcePhoneBook=1`). The generated Tcl script will run only on the machine it has been generated on and only if the corresponding Phonebook entry has not yet been deleted since the generation of the Tcl code.

`sourceRegSpecified`

If `useSourceRegBook` is 0, this option specifies the phone number. Default="SEP0000000[15000-]".

`sourceRegType`

Type of registration names.

0 = Specified by `sourceRegSpecified` as digits (default).

1 = Specified by `sourceRegBook` as a file name.

`sourceRegBook`

If `useSourceRegBook` is 1, this option specifies the phone book file name. Default="&lt;None&gt;".

## Transfer and Conference options

`useTransferPhoneBook`

Method used to select the phone number used to override transfer and conference phone number.

Value	Usage
0 (default)	Specify pattern.
1	Specify Phonebook entry.

**Note:** This options appears in the generated tcl code only if the test configuration contains a reference to a Phonebook entry (`transferPhoneBook`). The generated Tcl script will run only on the machine it has been generated on and only if the corresponding Phonebook entry has not yet been deleted since the generation of the Tcl code.

`transferPhoneSpecified`

If `useTransferPhoneBook` is 0, this option specifies the phone number. Default="180[00000000-]".

`transferPhoneType`

Type of transfer phone number type.

0 = Specified by `transferPhoneSpecified` as digits (default).

1 = Specified by `transferPhoneBook` as a file name.

`transferPhoneBook`

If `useTransferPhoneBook` is 1, this option specifies the phone book file name. Default="&lt;None&gt;".

`symTransferStr`

String identifying the VoIP Skinny Peer used for transfer and conference functions. Default="None".

`ovrTransferPhone`

Enables overriding of phone number from the transfer and conferencing VoIP Skinny Peer.

Value	Usage
0 (default)	Disabled
1	Enabled

### EXAMPLE

```
$Activity_VoIPSkinnyPeer1 agent.pm.dialPlan.config \-useSourcePhoneBook           0
\ -sourcePhoneSpecified      "160\[00000000-\]" \-sourcePhoneType           0
\ -sourcePhoneBook           "&lt;None&gt;" \

-useDestPhoneBook            0 \
-destPhoneSpecified          "170\[00000000-\]" \
-destPhoneType               0 \-destPhoneBook           "&lt;None&gt;" \

-symDestStr                  "None" \
-ovrDestPhone                false

-useSourceRegBook            0 \-sourceRegSpecified       "SEP0000000\[15000-
\]" \-sourceRegType          0 \-sourceRegBook           "&lt;None&gt;"
\ -useTransferPhoneBook      0 \-transferPhoneSpecified   "180\[00000000-\]"
\ -transferPhoneType         0 \-transferPhoneBook       "&lt;None&gt;" \-
symTransferStr               "None" \-ovrTransferPhone       false \
```

**SEE ALSO**



## Skinny Settings

VoIP Skinny Peer Signaling Settings

### SYNOPSIS

```
$Activity_VoIPSkinnyPeer1 agent.pm.signalingSettings.config \  
-optionvalue
```

### DESCRIPTION

This object defines the VoIP Skinny Peer Skinny settings.

### SUBCOMMANDS

None.

### OPTIONS

`enableSkinny`

Enables use of Skinny signaling for the VoIP Skinny Peer.

0 = Skiny disabled

1 = Skinny enabled (default)

`skinny_enableTos`

Enables use of TOS/DSCP. Use the `skinny_tos` option to specify the TOS/DSCP value.

0 = TOS disabled (default)

1= TOS enabled

`skinny_tos`

If `skinny_enableTos` is 1, this option sets the value of the TOS bits.

Value	Usage
0 (default)	Best Effort (0x00)
1	Class 1 (0x20)
2	Class 2 (0x40)
3	Class 3 (0x60)
4	Class 4 (0x80)

5	Express Forwarding (0xA0)
6	Control (0xC0)

seqRegistration

Enables Sequential Registration. 0 = Disabled (default), 1= Enabled.

failDirectly

If seqRegistration = 1, this option controls the registration failure behavior enforced by the Cisco CallManager.

0 = Do not fail if previously failed (default),

1= Fail registration if previously failed.

skinnyVersion

Version of Skinny protocol used.

0 = Skinny version 4 (default)

1 = Skinny version 5

ccm\_number

Cisco Call Manager number. (default = 0).

cmVersion

Cisco Call Manager version (default = 3.4). Note: This is a string value.

secondaryKeepAlive

Interval (in seconds) at which secondary keep alive messages are sent. (default = 60).

primaryKeepAlive

Interval (in seconds) at which primary keep alive messages are sent. (default = 60).

### EXAMPLE

```
$Activity_VoIPSkinnyPeer1 agent.pm.skinnySettings.config \-seqRegistration
false \-skinnyVersion                                0 \-skinnyServer
false \-_gbSeqRegistration                            false \-skinny_tos
0 \-skinny_enableTos                                 false \-_skinnyClient1
false \-ccm_number                                    0 \-failDirectly
false \-cmVersion                                     "3.4" \-secondaryKeepAlive
60 \-primaryKeepAlive                                30 \-enableSkinny
true \-_enableSkinny1                                 false
```

### SEE ALSO

[Call Managers](#)



## Call Managers

List of VoIP Skinny Peer Call Managers

### SYNOPSIS

```
$Activity_VoIPSkinnyPeer1 agent.pm.signalingSettings.appendItem \  
-optionvalue
```

### DESCRIPTION

This object contains the list of VoIP Skinny Peer Skinny Call Managers.

### SUBCOMMANDS

The following subcommands are available to handle options. Except where noted, no value is returned; an exception is raised in the case of an error. In all cases where they are used the `option` must begin with a hyphen (-). The `value` must be of a type appropriate for the option.

#### **appendItem** option value option value...

The `appendItem` subcommand may be used to add an item to a list. Any number of options in the listed item may be set as part of the append.

#### **configItem** index option value option value...

The `configItem` subcommand may be used to configure a particular item in a list. Any number of options in the list item may be set. The `index` argument is used to indicate which item in the list is to be configured.

#### **clear**

The `clear` subcommand may be used to delete all listed items from a list.

#### **deleteItem** index

The `deleteItem` subcommand may be used to delete a listed item from a list. The `index` argument is used to indicate which item in the list is to be configured.

#### **getItem** index

The `getItem` subcommand may be used to retrieve an item from a list. The `index` argument is used to indicate which item in the list is to be retrieved. This subcommand returns the object from the list.

#### **indexCount**

The `indexCount` subcommand returns the number of objects in the list.

**OPTIONS**

id

Name of the Call Manager. Default="callManager".

cmPort

Call Manager port number. Default="2000"

cmAddress

Call Manager IP address. Default="127.0.0.1"

**EXAMPLE**

```
$Activity_VoIPSkinnyPeer1 \ agent.pm.skinnySettings.callManagers.appendItem-id  
"callManager" \-cmPort      "2000" \-cmAddress    "127.0.0.1"
```

**SEE ALSO**

[Skinny Settings](#)

## Codec Settings

VoIP Skinny Peer Codec Settings

### SYNOPSIS

```
$Activity_VoIPSkinnyPeer1 agent.pm.codecSettings.codecs.appendItem \  
-optionvalue
```

```
$Activity_VoIPSkinnyPeer1 agent.pm.codecSettings.dataCodecs.appendItem \  
-optionvalue
```

### DESCRIPTION

Codec Settings contains the list of codecs that will be used by the VoIP Skinny Peers in the test. Codec Settings is a list of one or more `codec` (audio codec) or `dataCodec` objects. To add `codec` or `dataCodec` objects, use the `appendItem` command. To clear the codec settings, use the `clear` subcommand.

### SUBCOMMANDS

`clear`

Clears the list of codec settings. For example:

```
$Activity_VoIPSkinnyPeer1 agent.pm.codecSettings.codecs.clear
```

### OPTIONS

None.

### EXAMPLE

See the examples for `Data Codecs` and `Codecs`.

### SEE ALSO

[Data Codecs](#)

[Codecs](#)

## Data Codecs

VoIP Skinny Peer Data Codecs

### SYNOPSIS

```
$Activity_VoIPSkinnyPeer1 agent.pm.codecSettings.dataCodecs.appendItem \
-optionvalue
```

### DESCRIPTION

Data Codecs configures a data codec object, which is added to the `Codec Settings` list of codecs.

### SUBCOMMANDS

None.

### OPTIONS

`id`

Codec type. One of the following:

Codec	Description
Rtp2833Events	Named Events Payload format used for carrying DTMF digits and other line and trunk signals as events.
Rtp2833Tones	RTP Payload format that can represent tones consisting of one or more frequencies.

`dPayloadType`

Payload type used for RTP data packets. Default=(see table) min="96" max="127"

Codec	Default value for dPayloadType
Rtp2833Events	100
Rtp2833Tones	101

### EXAMPLE

```
$Activity_VoIPSkinnyPeer1 \ agent.pm.codecSettings.dataCodecs.clear
```

```
$Activity_VoIPSkinnyPeer1 \ agent.pm.codecSettings.dataCodecs.appendItem \
-id"Rtp2833Events" \
```

```
-dPayloadType100
```

```
$Activity_VoIPSkinnyPeer1 \ agent.pm.codecSettings.dataCodecs.appendItem \
```

```
-id"Rtp2833Tones" \
```

```
-dPayloadType101
```

### **SEE ALSO**

[Codec Settings](#)



## Codecs

VoIP Skinny Peer Audio Codec

### SYNOPSIS

```
$Activity_VoIPSkinnyPeer1 agent.pm.codecSettings.codecs.appendItem \
-optionvalue
```

### DESCRIPTION

Codecs configures an audio codec object, which is added to the `Codec Settings` list of codecs. To add a `codec` object, use the `appendItem` command.

### SUBCOMMANDS

None.

### OPTIONS

`id`

Codec type. One of the following:

Codec	Description
CodecAMR	Adaptive multi-rate codec
CodecG711u	G.711 mu-law codec
CodecG711a	G.711 A-law codec
CodecG723x153	G.723.1 codec @ 5.3 kbps
CodecG723x163	G.723.1 codec @ 6.3 kbps
CodecG726x16	G.726 codec @ 16 Kbps
CodecG726x24	G.726 codec @ 24 Kbps
CodecG726x32	G.726 codec @ 32 Kbps
CodecG729A	G.729 Annex-A codec

### Options for CodecAMR

`dPayloadIn`

Incoming dynamic payload type. Default="98" min="0" max="127".

`dPayloadOut`

Outgoing dynamic payload type. Default="98" min="0" max="127".

frameSize

Bytes per frame. Must be one of the following: 14. Default=14.

payloadFormat

Payload format.

Value	Usage
0 (default)	Bandwidth-efficient format
1	Octet-aligned format

mode

Codec bit rate. One of the following:

Mode	Description
0 (default)	4.75 kbps
1	5.15 kbps
2	5.90 kbps
3	6.70 kbps
4	7.40 kbps
5	7.95 kbps
6	10.20 kbps
7	12.20 kbps

### Options for CodecG711u

dPayloadIn

Incoming dynamic payload type. Default="0" min="0" max="127".

dPayloadOut

Outgoing dynamic payload type. Default="0" min="0" max="127".

frameSize

Bytes per frame. Must be one of the following: 40, 80, 160, 240. Default=160.

---

## Options for CodecG711a

dPayloadIn

Incoming dynamic payload type. Default="8" min="0" max="127".

dPayloadOut

Outgoing dynamic payload type. Default="8" min="0" max="127".

frameSize

Bytes per frame. Must be one of the following: 40, 80, 160, 240. Default=160.

## Options for CodecG723x153

dPayloadIn

Incoming dynamic payload type. Default="4" min="0" max="127".

dPayloadOut

Outgoing dynamic payload type. Default="4" min="0" max="127".

frameSize

Bytes per frame. Must be one of the following: 20. Default=20.

## Options for CodecG723x163

dPayloadIn

Incoming dynamic payload type. Default="4" min="0" max="127".

dPayloadOut

Outgoing dynamic payload type. Default="4" min="0" max="127".

frameSize

Bytes per frame. Must be one of the following: 24. Default=24.

## Options for CodecG723x163

dPayloadIn

Incoming dynamic payload type. Default="4" min="0" max="127".

dPayloadOut

Outgoing dynamic payload type. Default="4" min="0" max="127".

frameSize

Bytes per frame. Must be one of the following: 24. Default=24.

### Options for CodecG726x16

dPayloadIn

Incoming dynamic payload type. Default="102" min="0" max="127".

dPayloadOut

Outgoing dynamic payload type. Default="102" min="0" max="127".

byteOrder

Byte order.

Option	Description
0 (default)	Big Endian
1	Little Endian

frameSize

Bytes per frame. Must be one of the following: 20, 40, 60. Default=20.

### Options for CodecG726x24

dPayloadIn

Incoming dynamic payload type. Default="103" min="0" max="127".

dPayloadOut

Outgoing dynamic payload type. Default="103" min="0" max="127".

byteOrder

Byte order.

Option	Description
0 (default)	Big Endian
1	Little Endian

frameSize

Bytes per frame. Must be one of the following: 30, 60, 90. Default=30.

### Options for CodecG726x32

dPayloadIn

Incoming dynamic payload type. Default="104" min="0" max="127".

dPayloadOut

Outgoing dynamic payload type. Default="104" min="0" max="127".

byteOrder

Byte order.

Option	Description
0 (default)	Big Endian
1	Little Endian

frameSize

Bytes per frame. Must be one of the following: 40, 80, 120. Default=40.

### Options for CodecG729

dPayloadIn

Incoming dynamic payload type. Default="18" min="0" max="127".

dPayloadOut

Outgoing dynamic payload type. Default="18" min="0" max="127".

cbxFrameSize

Bytes per frame. Must be one of the following: 10, 20, 30, 40, 50, Custom. Default=10.

customFrameSize

If `cbxFrameSize` is Custom, this option configures the custom frame size. Default="120" min="10" max="200".

### EXAMPLE

```
$Activity_VoIPSkinnyPeer1 agent.pm.codecSettings.codecs.clear
```

```
$Activity_VoIPSkinnyPeer1 \ agent.pm.codecSettings.codecs.appendItem \
```

```
-id"CodecG711u" \
```

```
-dPayloadOut0 \
```

```
-dPayloadIn0 \
```

```
-frameSize160
```

```
$Activity_VoIPSkinnyPeer1 \ agent.pm.codecSettings.codecs.appendItem \
```

```
-id"CodecG711a" \
```

```
-dPayloadOut8 \  
-dPayloadIn8 \  
-frameSize160
```

### **SEE ALSO**

[Codec Settings](#)

## RTP Settings

VoIPSkinny Peer RTP Settings

### SYNOPSIS

```
$Activity_VoIPSkinnyPeer1 agent.pm.rtpSettings.config \  
-optionvalue
```

### DESCRIPTION

RTP Settings configures the VoIPSIPPeer RTP transport settings.

### SUBCOMMANDS

None.

### OPTIONS

enableRTP

Enables use of RTP to transport the media traffic.

0 = disabled (default)

1 = enabled

rtpPort

RTP port number. Default="10000".

**Note:** Valid port numbers are between 1000 and 65534.

enableRTCP

Enables the sending and receiving of RTCP packets.

chEnableHwAcc

If true, enables hardware acceleration for RTP traffic. Default=false.

enableAdvStatCalc

Enables the computation of advanced RTP statistics.

enablePerStream

Enables computation of per-stream statistics.

enableMDI

Enables the Media Delay Index.

enableNBExec

If `true`, all RTP functions from a scenario execute in a non-blocking mode, i.e the current function from a channel executes in the background, allowing the execution to continue on that channel with the next script function. Default= `False`.

### EXAMPLE

```
$Activity_VoIPSkinnyPeer1 agent.pm.rtpSettings.config \-enableRTP
true \-enableRTCP false \-enableMDI
false \-chEnableHwAcc true \-chDisableHwAcc
false \-enableAdvStatCalc false \-enablePerStream
false \-rtpPort "[10000-65535,4]" \-enableNBExec
false
```

### SEE ALSO



## Audio Settings

VoIPSkinny Peer audio settings

### SYNOPSIS

```
$Activity_VoIPSkinnyPeer1 agent.pm.audioSettings.config
```

### DESCRIPTION

The Audio Settings configure the VoIPSkinny Peer audio RTP settings.

### SUBCOMMANDS

None.

### OPTIONS

```
enableAudio
```

If selected, audio script functions are executed, otherwise they are skipped.

```
audioClip
```

The played audio clip file.

```
playTypeAudio
```

The mode in which the clip is played.

Value	Usage
0 (default)	The clip is played for clip duration or for the duration of the Talk Time parameter in the case of BHCA/CPS/LPS objectives.
1	The clip is played for a user-defined duration.

```
audioDurationUnit
```

The play duration unit, which can be milliseconds (0), seconds (1), minutes (2), or hours (3).

```
outputLevel
```

The output level of the played clip.

```
enableTosRtp
```

Enables use of TOS/DSCP. Use the `rtpTos` option to specify the TOS/DSCP value. Default= False

```
rtpTosVal
```

The Type of Service (TOS/DSCP) byte setting in the sent RTP packets has one of the following values:

- Best Effort (0x00): Routine service
- Class 1 (0x20): Priority service, Assured Forwarding class 1
- Class 2 (0x40): Immediate service, Assured Forwarding class 2
- Class 3 (0x60): Flash, Assured Forwarding class 3
- Class 4 (0x80): Flash-override, Assured Forwarding class 4
- Express Forwarding (0xA0): Critical-ecp
- Control (0xC0): Internet-control
- Custom: A user-specified value.

useMOS

Enables the computation of MOS scores. Default= False.

enableAudioOWD

If true, IxLoad computes the One-way Delay metric, a network measurement specifying the amount of time (in ms) that a packet has spent on the network before it was received on the destination side.

Default= False

useJitter

If true, enables use of a jitter buffer. Default= False.

jitMs

If useJitter is 1, this option configures the size of the jitter buffer, in milliseconds. Default="20" min="1" max="3000".

useJitComp

If true, enables dynamic modification of the jitter buffer size. Default= False.

jitCMs

If useJitComp is 1, this option configures the maximum size in of the jitter buffer, in milliseconds. Default="1000" min="0" max="3000".

jitCMaxDrop

If useJitComp is 1, this option configures the condition - a maximum number of consecutive packets dropped - that determines the jitter buffer size to be increased.

enableQoV

If true, this enables QoV P.862 PESQ and P.56 QoV computation. Default= False.

channelTypeQoV

When enableQoV is true, this specifies the objective type as either of the following:

- Number of channels (0)
- Percentage (1)

valueQoV

When `enableQoV` is `true`, this specifies the number of channels for which PESQ and P.56 QoV metrics are computed (when `channelTypeQoV` is 0). Alternatively this represents the percentage of channels for which PESQ and P.56 QoV metrics are computed (when `channelTypeQoV` is 1).

unitsQoV

The channels selection mode, which can be any of the following:

- First channels (0)
- Last channels (1)
- Evenly-spaced channels (2)
- Random (3)

metricsQoV

When `enableQoV` is `true`, this specifies the metric that is calculated by the Zion card. Available options are:

- PESQ and P.56 (0)
- PESQ (1)
- P56 (2)

useSilence

If `true`, RTP packets containing artificial background noise are sent when no other media (DTMF, MF, real payload, and so on) is sent over the communication channel. Default= `False`.

silenceMode

If `useSilence` is 1, this option configures the silence mode.

Value	Usage
0	Null data encoded
1 (default)	Comfort noise.

## EXAMPLE

```
$Activity_VoIPSkinnyPeer1 agent.pm.audioSettings.config \-enableAudio
true \-audioClip "US_042.wav" \-playTypeAudio
0 \-audioDurationUnit 1 \-audioDuration
10 \-outputLevel -20 \-enableAudioOWD
false \-enableTosRtp false \-rtpTosVal
32 \-useMos false \-useJitter
false \-jitMs 20 \-useJitComp
false \-jitCMs 1000 \-jitCMaxDrop
7 \-enableQoV false \-channelTypeQoV
```

```
0 \-valueQoV          100 \-unitsQoV
0 \-metricsQoV       0 \-useSilence
false \-silenceMode   1 \
```

### **SEE ALSO**

---

## Other Settings

VoIPSkinny Peer Other Settings

### SYNOPSIS

```
$Activity_VoIPSkinnyPeer1 agent.pm.otherSettings.config \  
-optionvalue
```

### DESCRIPTION

This object configures the VoIP Skinny Peer activity's miscellaneous options.

### SUBCOMMANDS

None.

### OPTIONS

VOIP\_Var0

The VOIP\_Var1...VOIP\_Var5 and VOIP\_IPAddr1...VOIP\_IPAddr5 string-type variables supporting generator expressions enable you to generate 10 series of global variables whose values are used at runtime by the simulated Skinny phones/channels. `Default=""`.

Use the VOIP\_Var1...VOIP\_Var5 variables to represent phone numbers, and the VOIP\_IPAddr1...VOIP\_IPAddr5 to represent IP addresses.

VOIP\_Var1

See VOIP\_Var0.

VOIP\_Var2

See VOIP\_Var0.

VOIP\_Var3

See VOIP\_Var0.

VOIP\_Var4

See VOIP\_Var0.

VOIP\_IPAddress0

See VOIP\_Var0.

VOIP\_IPAddress1

See VOIP\_Var0.

VOIP\_IPAddress2

See VOIP\_Var0.

VOIP\_IPAddress3

See VOIP\_Var0.

VOIP\_IPAddress4

See VOIP\_Var0.

ipPreference

Type of addressing to be used on the subnet that the VOIP Skinny Peer runs on.

Value	Usage
0 (default)	IPv4
1	IPv6

### EXAMPLE

```
$Activity_VoIPSkinnyPeer1 agent.pm.otherSettings.config \-ipPreference
0 \-VOIP_Var1                               """ \-VOIP_Var0
""" \-VOIP_Var3                               """ \-VOIP_Var2
""" \-VOIP_Var4                               """ \-VOIP_IPAddress4
""" \-VOIP_IPAddress1                         """ \-VOIP_IPAddress0
""" \-VOIP_IPAddress3                         """ \-VOIP_IPAddress2
"""
```

### SEE ALSO

## Custom Activity Link Settings

VoIP Skinny Peer CustomActivityLinkSettings

### SYNOPSIS

```
$Activity_VoIPSkinnyPeer1 agent.pm.customActivityLinkSettings.config \
-option value
```

### DESCRIPTION

CustomActivityLinkSettings configures the settings for the BHCA objective for VoIPSkinny Peer activities. This options in this object correspond to the controls on the Custom Parameters tab for a NetTraffic/ActivityLink in the Timeline and Objective branch of the Test Configuration tree in the IxLoad GUI.

**Note:** The CustomActivityLinkSettings class has to be configured alongside the CustomParameters class that implements the same functionality.

### SUBCOMMANDS

None.

### OPTIONS

talkTime

If `bhcaType` is 0, this option specifies the Talk Time that will be used to attain the BHCA test objective. Default="40000".

interCallDuration

Inter-call duration. Default="4000".

bhcaType

Determines how the BHCA objective will be met: by specifying the talk time or the number of channels.

Value	Usage
0 (default)	BHCA will be met by specifying the talk time. Specify the talk time in <code>talkTime</code> .
1	BHCA will be met by specifying the number of channels. Specify the number of channels in <code>channelsNo</code> .

channelsNo

If `bhcaType` is 1, this option specifies the number of channels that will be used to attain the BHCA test objective. Default="100".

callSetupTime

Estimated call setup time. Default="500".

callTeardownTime

Estimated call teardown time. Default="500".

bhcaObjectiveValue

BHCA objective value. Default="80000".

### **EXAMPLE**

```
$Activity_VoIPSkinnyPeer1 \ agent.pm.customActivityLinkSettings.config\  
-talkTime40000 \  
-channelsNo100 \  
-bhcaType0 \  
-callTeardownTime500 \  
-interCallDuration4000 \  
-bhcaObjectiveValue80000 \  
-callSetupTime500
```

### **SEE ALSO**



## Custom Parameters

VoIPSkinny Peer CustomParameters

### SYNOPSIS

```
$Activity_VoIPSkinnyPeer1 customParameters.config \  
-option value
```

### DESCRIPTION

CustomParameters configures the settings for the BHCA objective for VoIPSkinny Peer activities. This options in this object correspond to the controls on the Custom Parameters tab for a NetTraffic/ActivityLink in the Timeline and Objective branch of the Test Configuration tree in the GUI.

**Note:** The CustomParameters class has to be configured alongside the CustomActivityLinkSettings class that implements the same functionality.

### SUBCOMMANDS

None.

### OPTIONS

talkTime

If bhcaType is 0, this option specifies the Talk Time that will be used to attain the BHCA test objective. Default="40000".

interCallDuration

Inter-call duration. Default="4000".

bhcaType

Determines how the BHCA objective will be met: by specifying the talk time or the number of channels.

Value	Usage
0 (default)	BHCA will be met by specifying the talk time. Specify the talk time in talkTime.
1	BHCA will be met by specifying the number of channels. Specify the number of channels in channelsNo.

channelsNo

If bhcaType is 1, this option specifies the number of channels that will be used to attain the BHCA test objective. Default="100".

callSetupTime

Estimated call setup time. Default="500".

callTeardownTime

Estimated call teardown time. Default="500".

bhcaObjectiveValue

BHCA objective value. Default="80000".

### **EXAMPLE**

```
$Activity_VoIPSkinnyPeer1 customParameters.config\
```

```
-talkTime40000 \
```

```
-channelsNo100 \
```

```
-bhcaType0 \
```

```
-callTeardownTime500 \
```

```
-interCallDuration4000 \
```

```
-bhcaObjectiveValue80000 \
```

```
-callSetupTime500
```

### **SEE ALSO**

! 42

## VoIP No Call Control Peer

The IxLoad VoIP No Call Control Peer Tcl API consists of a VoIP No Call Control Peer agent, with separate APIs for configuring each major aspect of the agent's functionality.

### Limitations

The following restrictions and limitations of the VoIP No Call Control Peer API exist:

- The PhoneBook and other related classes, such as PhoneBookEntry, cannot be edited from the Tcl API.
- Individual VoIP No Call Control script functions cannot be added and edited from the Tcl API. Instead, you must add and configure the commands in the Scenario Editor, save the test scenario file, then pass it as an argument to the `Scenario Settings` API class.

## VoIP No Call Control Peer API Commands

The IxLoad VoIP No Call Control Peer API commands are organized as shown in the figure below.

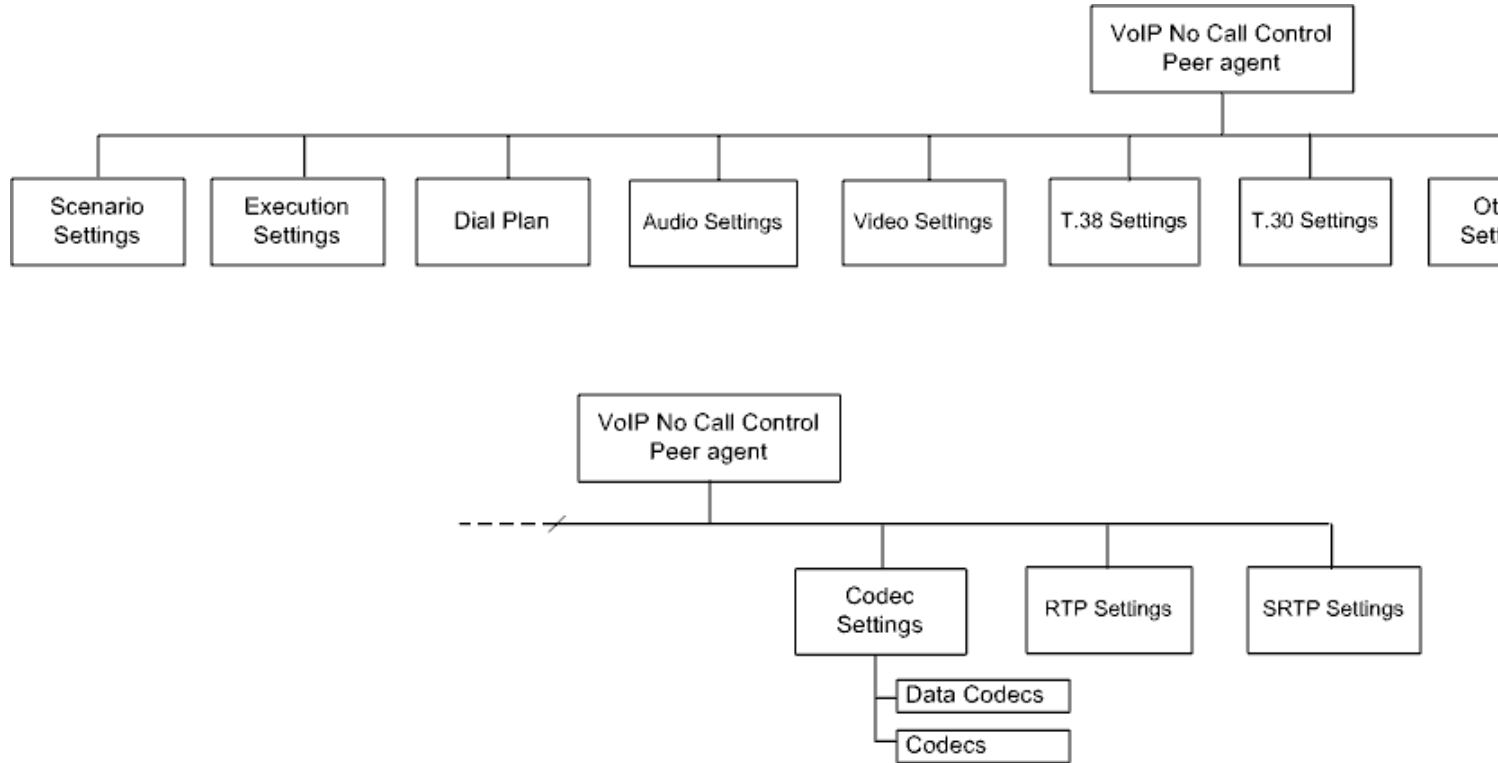

## VoIP No Call Control Peer API Objects

The table below summarizes the objects in the VoIP No Call Control Peer API.

Object	Description
VoIP No Call Control Peer Agent	Top-level object defining the VoIP No Call Control Peer activity.
Execution Settings	Run-time test configuration; corresponds to the Execution Settings GUI tab.
Scenario Settings	Selects the Test Scenario file; corresponds to the Scenario Settings GUI tab.
Dial Plan	Configures the source, destination, and transfer addresses and phone numbers for the channels/endpoints; corresponds to the Dial Plan GUI tab.
Codec Settings	Contains a list of <code>Data Codecs</code> and <code>Codecs</code> objects.
Data Codecs	Data codec with parameters.
Codecs	Audio codec with parameters.
RTP Settings	RTP transport configuration; corresponds to the RTP Settings GUI tab.
Audio Settings	Audio settings; corresponds to the Audio GUI tab.
Video Settings	Video settings; corresponds to the Video GUI tab.
T.38 Settings	T.38 IP fax settings; corresponds to the T.38 GUI tab.
T.30 Settings	T.30 settings; corresponds to the T.30 GUI tab.
SRTP Settings	SRTP configuration corresponding to the SRTP Settings GUI tab.
Other Settings	VoIP No Call Control Peer miscellaneous parameters; corresponds to the Other Settings tab in GUI.

## VoIP No Call Control Peer Agent

VoIP No Call Control Peer Agent

### SYNOPSIS

```
set Activity_VoIPNoCCPeer1 [$Traffic_Network1 activityList.appendItem \-  
protocolAndType "VoIPNoCC Peer" ]
```

### DESCRIPTION

A VoIP No Call Control Peer agent is added to the `agentList` option of the `ixConfig` object using the `appendItem` subcommand from the `ixConfigSequenceContainer` command. Other `ixConfigSequenceContainer` subcommands may be used to modify the `agentList`. See the following example:

```
set Activity_VoIPNoCCPeer1 [$Traffic_Network1 activityList.appendItem \-  
protocolAndType "VoIPNoCC Peer" ]
```

```
$Activity_VoIPNoCCPeer1 config \-enable true \-name  
"VoIPNoCCPeer1" \-enableConstraint false \-userObjectiveValue  
1 \-constraintValue 100 \-userObjectiveType  
"channels" \-timeline $Timeline1
```

```
$Activity_VoIPNoCCPeer1 agent.config \-cmdListLoops true  
\
```

Each member of the list, however may be separately addressed and modified using the `ixConfig` subcommands. For example, the first agent uses an index of 0 and its name may be modified by:

```
$Activity_VoIPNoCCPeer1 agent(0).config -name "VoIPNoCC Peer new"
```

### SUBCOMMANDS

None.

### OPTIONS

`enable`

Enables the use of this agent. (Default = true).

`name`

The name associated with this object, which must be set at object creation time.

`timeline`

The timeline configured for the test.

## STATISTICS

The statistics published by this agent are listed in [VoIP No Call Control Statistics](#).

### EXAMPLE

```
set my_network1 [::IxLoad new ixNetTraffic]
```

```
##### Activity VoIPNoCCPeer1 of
NetTraffic my_network1#####set Activ-
ity_VoIPNoCCPeer1 [$my_network1 activityList.appendItem \-protocolAndType
"VoIPNoCC Peer" ]##### Timelinel
for activitiy VoIPNoCCPeer1#####set
Timelinel [::IxLoad new ixTimeline]
```

```
$Timelinel config \-rampUpValue 1 \-rampUpType
0 \-offlineTime 0 \-rampDownTime
60 \-standbyTime 0 \-iterations
1 \-rampUpInterval 1 \-sustainTime
80 \-timelineType 0 \-name
"Timelinel"
```

```
$Activity_VoIPNoCCPeer1 config \-enable true \-name
"VoIPNoCCPeer1" \-enableConstraint false \-userObjectiveValue
1 \-constraintValue 100 \-userObjectiveType
"channels" \-timeline $Timelinel
```

## SEE ALSO

[ixConfig](#)

## NoCallControl VOIP Statistics

The following No Call Control statistics are computed:

Statistic	Description	Advanced	Per Channel/Global
<b>Channels</b>			
Successful Channels	The instantaneous number of COMPLETED channels. A channel is COMPLETED if all the channel loops were COMPLETED.	-	Global
Warning Channels	The instantaneous number of WARNING channels. A channel is WARNING if all the channel loops were COMPLETED or WARNING and at least one loop had a WARNING result.	-	Global
Failed Channels	The instantaneous number of FAILED channels. A channel is FAILED if all the channel loops were COMPLETED or WARNING, and at least one loop was FAILED.	-	Global
Aborted Channels	The instantaneous number of ABORTED channels. A channel is ABORTED if all the channel loops were COMPLETED, WARNING, FAILED, or ABORTED and at least one loop was ABORTED.	-	Global
Active Channels	The instantaneous number of active channels. Active channels are the channels executing a scenario channel functions flow.	-	Global
Total Channels	The instantaneous total number of channels, a sum of active and non-active channels.	-	Global
<b>Loops</b>			
Successful Channel Loops	The cumulative count of COMPLETED channel loops. A channel loop is COMPLETED if all executed script functions in the corresponding scenario channel produced SKIPPED or COMPLETED results.	-	Global
Warning Channel Loops	The cumulative count of WARNING channel loops. A channel loop has a WARNING result if all executed script functions in the corresponding scenario channel produced SKIPPED, COMPLETED, or WARNING results and at least one script function had a WARNING result.	-	Global



Failed Channel Loops	The cumulative count of FAILED channel loops. A channel loop is FAILED if all executed script functions in the corresponding scenario channel produced SKIPPED, COMPLETED, WARNING, or FAILED results and at least one script function had a FAILED result.	-	Global
Aborted Channel Loops	The cumulative count of ABORTED channel loops. A channel loop is FAILED if all the executed script functions in the corresponding scenario channel produced SKIPPED, COMPLETED, WARNING, FAILED, or ABORTED results and at least one script function had an ABORTED result.	-	Global
Total Channel Loops	The cumulative count of executed loops.	-	Global
Interloop Duration (Avg) [ms]	The average time gap between loops.	-	Global
<b>Bytes</b>			
Bytes Sent	The total number (cumulative) of bytes sent in RTP packets, including the RTP header and the RTP payload.	-	Both
Bytes Received	The total number (cumulative) of bytes received in RTP packets, including the RTP header and the RTP payload.	-	Both
<b>Errors</b>			
Transport Errors	The cumulative count of transport errors, occurring when a SIP message could not be sent due to a socket error or a failed DNS server query.	-	Global
Trigger Errors	The cumulative count of trigger errors.	-	Global

RTP Errors	The cumulative count of RTP related errors, incremented when any RTP script function is failing or exiting on the Warning or Timeout outputs. Possible causes include media sessions that have been closed by the signaling engine, or <b>Generate DTMF/MF/Tone</b> or <b>Detect DTMF/MF/Tone</b> functions that failed. This statistic is also incremented when the signaling engine cannot start a media session, such as when the negotiated codec or the negotiatedptime is unsupported.	-	Global
Internal Errors	The cumulative count of internal errors.	-	Global
Timeout Errors	The cumulative count of script functions that have timed out.	-	Global
<b>RTP MOS</b>			
MOS Instant (Avg)	The per polling interval MOS score.	No	Global
MOS Instant Worst	The per polling interval lowest MOS score.	No	Global
MOS Instant Best	The per polling interval highest MOS score.	No	Global
MOS	The average MOS score for the elapsed test duration.	No	Both
MOS Worst	The lowest MOS score for the elapsed test duration.	No	Both
MOS Best	The highest MOS score for the elapsed test duration.	No	Both
MOS Per Call (Avg)	The average MOS score per call.	No	Global
MOS Per Call Worst	The lowest MOS score per call.	No	Global
MOS Per Call Best	The highest MOS score per call.	No	Global
<b>RTP MOS per Call Distribution</b>			

Excellent - calls with MOS between 4 and 4.5	The percentage of calls with MOS score values between 4 and 5	No	Global
Good - calls with MOS between 3.5 and 4	The percentage of calls with MOS score values between 3.5 and 4	No	Global
Fair - calls with MOS between 3 and 3.5	The percentage of calls with MOS score values between 3 and 3.5	No	Global
Poor - calls with MOS between 2 and 3	The percentage of calls with MOS score values between 2 and 3	No	Global
Bad - calls with MOS between 1 and 2	The percentage of calls with MOS score values between 1 and 2	No	Global
<b>RTP MOS Instant</b>			
Calls with excellent MOS (4 - 4.5)	The instantaneous number of calls with MOS scores between 4 and 4.5	No	Global
Calls with good MOS (3.5 - 4)	The instantaneous number of calls with MOS scores between 3.5 and 4	No	Global
Calls with fair MOS (3 - 3.5)	The instantaneous number of calls with MOS scores between 3 and 3.5	No	Global
Calls with poor MOS (2 - 3)	The instantaneous number of calls with MOS scores between 2 and 3	No	Global

Calls with bad MOS (1 - 2)	The instantaneous number of calls with MOS scores between 1 and 2	No	Global
Intervals with excellent MOS (4 - 4.5)	The number of intervals with MOS scores between 4 and 4.5 <b>Note:</b> For the purpose of MOS computation, calls are sequenced into intervals with a duration of 4 seconds.	No	Global
Intervals with good MOS (3.5 - 4)	The number of intervals with MOS scores between 3.5 and 4 <b>Note:</b> For the purpose of MOS computation, calls are sequenced into intervals with a duration of 4 seconds.	No	Global
Intervals with fair MOS (3 - 3.5)	The number of intervals with MOS scores between 3 and 3.5 <b>Note:</b> For the purpose of MOS computation, calls are sequenced into intervals with a duration of 4 seconds.	No	Global
Intervals with poor MOS (2 - 3)	The number of intervals with MOS scores between 2 and 3 <b>Note:</b> For the purpose of MOS computation, calls are sequenced into intervals with a duration of 4 seconds.	No	Global
Intervals with bad MOS (1 - 2)	The number of intervals with MOS scores between 1 and 2 <b>Note:</b> For the purpose of MOS computation, calls are sequenced into intervals with a duration of 4 seconds.	No	Global
<b>RTP Jitter and Delay</b>			
Interarrival Jitter Average ( $\mu$ s)	The per polling interval interarrival jitter value over RTP streams, in microseconds (as defined in RFC 3550).	Yes	Both
Interarrival Jitter Max ( $\mu$ s)	The maximum <i>Interarrival Jitter Average (ms)</i> value among RTP streams for the elapsed test duration, in microseconds (as defined in RFC 3550).	Yes	Global
Delay Variation Jitter Average ( $\mu$ s)	The per polling interval delay variation jitter value calculated for all packets, in microseconds (as defined in RFC 3550).	Yes	Both

Delay Variation Jitter Max ( $\mu$ s)	The maximum value of the <i>Delay Variation Jitter Average (ms)</i> value for the elapsed test duration, in microseconds (as defined in RFC 3550).	Yes	Global
One Way Delay Average ( $\mu$ s)	The per polling interval time spent by the packet on the network from the moment it is sent until it is received. <b>Note:</b> Depending on whether RTCP support is selected or not, the OWD computation method is different: <ul style="list-style-type: none"> <li>• With RTCP support selected, the OWD value is computed at different time intervals, using RTCP information</li> <li>• Without RTCP support selected, the OWD value is computed for every RTP packet sent, using an RTP header extension.</li> </ul>	No	Both
One Way Delay Max ( $\mu$ s)	The maximum <i>One Way Delay Average (ms)</i> value for the elapsed test duration.	No	Global
<b>RTP QoS</b>			
Bytes Sent	The total number (cumulative) of bytes sent in RTP packets, including the RTP header and the RTP payload.	No	Both
Packets Sent	The total number (cumulative) of sent RTP packets.	No	Both
Bytes Received	The total number (cumulative) of bytes received in RTP packets, including the RTP header and the RTP payload.	No	Both
Packets Received	The total number (cumulative) of received RTP packets.	No	Both
Bytes Sent/s	The rate of sent RTP bytes, including the RTP header and the RTP payload.	No	Both
Bytes Received /s	The rate of received RTP bytes, including the RTP header and the RTP payload.	No	Both
Throughput inbound	The inbound bandwidth, taking into account the RTP header and payload.	No	Both

Throughput outbound	The outbound bandwidth, taking into account the RTP header and payload.	No	Both
Tx Packets Dropped	The total number of RTP packets dropped at transmission.	No	Global
Lost Packets	The total number (cumulative) of lost RTP packets, defined as the difference between the number of packets expected at the receiving side and the actual number of packets received.	No	Both
Maximum Consecutive Lost Packets	The maximum number of consecutive RTP packets lost.	No	Both
Bytes Lost Percentage [%]	The percentage of lost bytes.	No	Both
Packet Errors Received	The total number (cumulative) of packets received with RTP header errors.	No	Both
Packet Size Mismatched	The total number (cumulative) of RTP packet size mismatches (packets that have other size than expected).	Yes	Both
Packet Codec Mismatched	The total number of RTP codec mismatches (packets that have other payload type than expected).	Yes	Both
Duplicate Packets Received	The total number (cumulative) of successive RTP packets received with the same sequence number.	No	Both
Late Packets Received	The total number (cumulative) of RTP packets received with a delay greater than the GUI-defined jitter buffer size (expressed in milliseconds).	No	Both
Misordered Packets Received	The total number (cumulative) of RTP packets with the sequence number smaller than the previous valid sequence number.	No	Both
<b>RTP Packet Errors</b>			
Packet Loss Correlation	A counter defining the "burstiness" of the packet loss, computed as the number of lost packets divided by the number of loss sequences.	Yes	Both

Packet Loss Percentage [%]	The percentage of RTP packets received with errors.	Yes	Both
Packet Misorder Percentage [%]	The percentage of misordered packets.	Yes	Both
Packet Errors Percentage [%]	The percentage of RTP packets received with errors.	Yes	Both
Packet Duplicate Percentage [%]	The percentage of RTP duplicate packets.	Yes	Both
<b>RTP Jitter Distribution</b>			
RTP Packets With Delay Variation Jitter Up To 1ms	The number of packets received with delay variation jitter up to 1 millisecond (ms).	No	Both
RTP Packets With Delay Variation Jitter Up To 3ms	The number of packets received with delay variation jitter up to 3 milliseconds (ms).	No	Both
RTP Packets With Delay Variation Jitter Up To 5ms	The number of packets received with delay variation jitter up to 5 milliseconds (ms).	No	Both
RTP Packets With Delay Variation Jitter Up To 10ms	The number of packets received with delay variation jitter up to 10 milliseconds (ms).	No	Both

RTP Packets With Delay Variation Jitter Up To 20ms	The number of packets received with delay variation jitter up to 20 milliseconds (ms).	No	Both
RTP Packets With Delay Variation Jitter Up To 40ms	The number of packets received with delay variation jitter up to 40 milliseconds (ms).	No	Both
RTP Packets With Delay Variation Jitter More Than 40ms	The number of packets received on the stream with delay variation jitter over 40 milliseconds (ms).	No	Both
<b>RTP DTMF, MF and Tone</b>			
DTMF Digits Sent	The total number of DTMF digits sent by the <b>Generate DTMF</b> and the <b>Path Confirmation</b> (using DTMFs) script function.	No	Both
DTMF Sequences Sent	The total number of DTMF digits sequences sent by the <b>Generate DTMF</b> and the <b>Path Confirmation</b> (using DTMFs) script function.	No	Both
DTMFs Detected	The total number of DTMF digits detected.	No	Both
DTMFs Matched	The total number of received DTMF sequences that matched the sequence specified in the <b>Detect DTMF</b> or the <b>Path Confirmation</b> script function.	No	Both
DTMFs Not Matched	The total number of received DTMF sequences that did not match the sequence specified in the <b>Detect DTMF</b> or the <b>Path Confirmation</b> script function.	No	Both
Good DTMF Sequences Detected	The total number of DTMF sequences detected and matched by the <b>Path Confirmation</b> script function.	No	Both
Bad DTMF Sequences Detected	The total number of path confirmation DTMF sequences detected, but not matched, by the <b>Path Confirmation</b> script function.	No	Both



DTMF Detection Timeout	The total number of DTMF detection attempts that ended because of a timeout condition.	No	Both
MF Digits Sent	The total number of MF digits sent by the <b>Generate MF</b> or the <b>Path Confirmation</b> (using MFs) script function.	No	Both
MF Sequences Sent	The total number of MF sequences sent by <b>Generate MF</b> or the <b>Path Confirmation</b> (using MFs) script function.	No	Both
MFs Detected	The total number of MF digits detected.	No	Both
MFs Matched	The total number of received MF sequences that matched the sequence specified in the <b>Detect MF</b> or the <b>Path Confirmation</b> script function.	No	Both
MFs Not Matched	The total number of received MF sequences that did not match the sequence specified in the <b>Detect MF</b> or the <b>Path Confirmation</b> script function.	No	Both
Good MF Sequences Detected	The total number of path confirmation MF sequences detected and matched by the <b>Path Confirmation</b> script function.	No	Both
Bad MF Sequences Detected	The total number of path confirmation MF sequences detected, but not matched, by the <b>Path Confirmation</b> script function.	No	Both
MF Detection Timeout	The total number of MF detection attempts that ended because of a timeout condition.	No	Both
Custom Tones Sent	The total number of custom tones sent by the <b>Generate Tone</b> or the <b>Path Confirmation</b> (using custom tones) script function.	No	Both
Custom Tone Sequences Sent	The total number of sent custom tone sequences by the <b>Generate Tone</b> or the <b>Path Confirmation</b> (using custom tones) script function.	No	Both
Custom Tones Detected	The total number of detected custom tones.	No	Both

Custom Tones Matched	The total number of matched custom tones.	No	Both
Custom Tones Not Matched	The total number of not matched custom tones	No	Both
Custom Tone Detection Timeout	The total number of custom tone detection attempts that ended because of a timeout condition. This statistic is also incremented when the synchronization tone timeout of the <b>Path Confirmation</b> function expires. Path Confirmation functions use such a tone for the purpose of synchronizing functions on different channels.	No	Both
<b>RTP R-Factor &amp; MOS Degradation</b>			
R-Factor Instant (Avg)	The per polling interval value for the capability of the RTP channel to support audio transmissions.	Yes	Both
R-Factor Instant Worst	The per polling interval lowest <i>R-Factor Instant (Avg)</i> value.	Yes	Both
R-Factor Instant Best	The per polling interval highest <i>R-Factor Instant (Avg)</i> value.	Yes	Both
MOS Instant (Avg)	The per polling interval MOS score.	No	Both
MOS Instant Worst	The per polling interval lowest <i>MOS Instant (Avg)</i> score.	No	Both
MOS Instant Best	The per polling interval highest <i>MOS Instant (Avg)</i> score.	No	Both
Loss Degradation	The per polling interval quality degradation that can be attributed to network packet loss.	Yes	Both
Jitter Degradation	The per polling interval quality degradation due to the packet discards in conditions of jitter buffer overflow or downflow.	Yes	Both
Delay Degradation	The per polling interval quality degradation that can be attributed to delay.	Yes	Both

Codec Degradation	The per polling interval quality degradation that can be attributed to audio encoder/decoder selection.	Yes	Both
<b>RTP Consecutive Lost Datagrams Distribution</b>			
Consecutive Lost of One Packet Sequences	The per test total number of consecutive one lost RTP packet sequences.	Yes	Both
Consecutive Lost of Two or Three Packets Sequences	The per test total number of consecutive two or three lost RTP packets sequences.	Yes	Both
Consecutive Lost of Four or Five Packets Sequences	The per test total number of consecutive four or five lost RTP packets sequences.	Yes	Both
Consecutive Lost of Six to Ten Packets Sequences	The per test total number of consecutive six to ten lost RTP packets sequences.	Yes	Both
Consecutive Lost of Eleven or More Packets Sequences	The per test total number of consecutive more than ten lost RTP packets sequences.	Yes	Both
<b>RTP Playbacks &amp; Records</b>			
Successful Records	The total number (cumulative statistic) of successful RTP records, incremented when the last RTP packet of an encoded wave file was received. This statistic is incremented only when the <b>Talk</b> or <b>VoiceSession</b> script functions are present in the scenario.	No	Global

Successful Playbacks	The total number (cumulative statistic) of successful RTP playbacks, incremented when the last RTP packet of an encoded wave file was transmitted. This statistic is incremented only when the <b>Talk</b> or <b>VoiceSession</b> script functions are present in the scenario.	No	Global
Failed Records	The total number (cumulative statistic) of failed RTP records, incremented when the <b>Talk</b> or <b>VoiceSession</b> functions fail due to either of the following reasons: <ul style="list-style-type: none"> <li>• The signaling engine has not negotiated a corresponding media session that has Rx or RxTx capabilities.</li> <li>• The RTP function is disconnected due to the signaling engine closing the media session.</li> </ul>	No	Global
Failed Playbacks	The total number (cumulative statistic) of failed RTP playbacks, incremented when the <b>Talk</b> or <b>VoiceSession</b> functions fail due to either of the following reasons: <ul style="list-style-type: none"> <li>• The signaling engine has not negotiated a corresponding media session that has Tx or TxRx capabilities.</li> <li>• The RTP function is disconnected due to the signaling engine closing the media session.</li> </ul>	No	Global
Functions Disconnected	The total number (cumulative statistic) of failed RTP playbacks, incremented when the Multimedia Session function fails due to the following reason: <ul style="list-style-type: none"> <li>• The function is disconnected due to the signaling engine closing the media session.</li> </ul>	No	Global
<b>RTCP</b>			
RTCP Packet Size TX (Avg)	The per polling interval average outbound RTCP packet size.	No	Both
RTCP Packet Size RX (Avg)	The per polling interval average inbound RTCP packet size.	No	Both

RTCP Packet Transmission Time (Avg) [ms]	The per polling interval amount of time between the last two consecutive RTCP packets sent.	No	Both
RTCP Packet Arrival Time (Avg) [ms]	The per polling interval amount of time between the last two consecutive RTCP packets received.	No	Both
RTCP Packets Sent, RTCP Packets Received	The total number (cumulative) of sent/received RTCP packets.	No	Both
<b>SRTP</b>			
Negotiated Unsecured Streams	The total number of unsecured streams negotiated.	No	Global
Negotiated Secured Streams	The total number of secured streams negotiated.	No	Global
SRTP Packets Sent, SRTP Packets Received	The total number (cumulative) of sent/received SRTP packets.	No	Global
SRTP Packets Discarded	The number of packets that failed the SRTP validation.	No	Global
SRTCP Packets Discarded	The number of packets that failed the SRTCP validation.	No	Global
SRTP Master Key Switches	The number of times the master key used was switched within an existing stream (number of re-keying's).	No	Global
<b>Media Flows</b>			
Expected Audio Flows	The cumulative count of negotiated audio flows.	No	Global

Audio Flows	The cumulative count of actually sent audio flows.	No	Global
Audio Con-current Flows	The instantaneous number of audio flows.	No	Global
Expected Video Flows	The cumulative count of negotiated video flows.	No	Global
Video Flows	The cumulative count of actually sent video flows.	No	Global
Video Con-current Flows	The instantaneous number of video flows.		
Expected T.38 Flows	The cumulative count of negotiated T.38 flows.	No	Global
T.38 Flows	The cumulative count of actually sent T.38 flows.	No	Global
Expected Media Flows	The cumulative count of negotiated media flows, a sum of audio and video flows.	No	Global
Media Flows	The cumulative count of actually transmitted media flows, a sum of audio and video flows.	No	Global
<b>RTP Per Channel</b>			
Per-channel RTP statistics comprise statistics from the other categories marked with the <b>Both</b> value in the <i>Per Channel / Global</i> column, plus the following:			
Local IP and Port	The channel local IP and port.	No	Per Channel
Destination IP and Port	The channel remote IP and port.	No	Per Channel
Largest Bytes Gap	The number of RTP bytes comprised in a consecutive sequence of lost packets, calculated as the maximum consecutive number of packets lost multiplied by the dimension of the RTP data in one packet.		Per Channel

---

## Scenario Settings

VoIP No Call Control Peer Scenario Settings

### SYNOPSIS

```
$Activity_VoIPNoCCPeer1 agent.pm.scenarioSettings.config \  
-option value
```

### DESCRIPTION

Scenario Settings specifies the test scenario file used by the Tcl API script.

### SUBCOMMANDS

None.

### OPTIONS

scenarioFile

The full path to the test scenario file for the activity.

activeScenarioChannel

Test scenario channel (0-based index) that is associated with the VoIP No Call Control Peer activity (Default=0).

### EXAMPLE

```
$Activity_VoIPNoCCPeer1 agent.pm.scenarioSettings.config \  
-scenarioFile"D:\\ScenarioTestFiles\\RTPCall.tst" \  
-activeScenarioChannel0
```

### SEE ALSO

## Execution Settings

VoIP No Call Control Peer Execution Settings

### SYNOPSIS

```
$Activity_<VoIPNoCCPeer activity name>agent.pm.executionSettings.config \  
-optionvalue
```

### DESCRIPTION

This object defines the execution settings for the VoIP No Call Control Peer activity.

### SUBCOMMANDS

None.

### OPTIONS

rtpIpRule

A simulated RTP channel is uniquely identified by the IP address and port. This option selects the rule used for the IP address portion of the RTP channel allocation.

- 0 = Use same value (per port) (default)
- 1 = Use consecutive values (per port)
- 2 = Use same value for every *x* channels. Specify the value for *x* in the `rtpIpRuleCh` parameter.

rtpPortRule

This option selects the rule used for the port portion of the RTP channel allocation.

- 0 = Use same value (default)
- 1 = Use consecutive values (per port)
- 2 = Use consecutive values (per activity)
- 3 = Use same value for every *x* channels. Specify the value for *x* in `rtpPortRuleCh`.

gracefulRampDown

If configured `true`, the execution is stopped gracefully and the call is closed before the ramp-down period ends.

rtpIpRuleCh

If `rtpIpRule` is `Use same value every`, this specifies the number of channels.

rtpPortRuleCh

If `rtpPortRule` is `Use same value every`, this parameter specifies the number of channels.

loopMode



Defines how many loops are executed for every voice channel corresponding to this activity.

Value	Description
0 (default)	Loop for the entire test duration.
1	Execute a number of loops. Specify the number of loops in loopCount.

loopCount

If loopMode is 1, this option defines the number of loops that the test performs. Default="1".

loopPreDelay

Delay before first loop (ms). Default="0", min="0" max="3600000".

loopMidDelay

Delay between loops (ms). Default="0" min="0" max="3600000".

### EXAMPLE

```
$Activity_VoIPNoCCPeer1 agent.pm.executionSettings.config \
```

```
-rtpPortRule          0 \
-gracefulRampDown     true \
-rtpIpRule            1 \
-rtpIpRuleCh         1 \
-rtpPortRuleCh       1 \
-loopPreDelay        0 \
-loopMode            0 \
-loopCount           1 \
-loopMidDelay        0
```

### SEE ALSO

## Dial Plan

VoIP No Call Control Peer Dial Plan

### SYNOPSIS

```
$Activity_VoIPNoCCPeer1 agent.pm.dialPlan.config \  
-option value
```

### DESCRIPTION

The Dial Plan object configures the destination for the RTP traffic generated by the VoIPNoCCPeer activity.

### SUBCOMMANDS

None.

### OPTIONS

`rtpIpRule2`

This option selects the rule used for the IP address portion of the destination RTP channel, when a DUT of the 'Virtual DUT' type is configured.

- 0 = Use same value (per port) (default)
- 1 = Use consecutive values (per port)
- 2 = Use same value for every x channels. Specify the value for x in the `rtpIpRuleCh2` parameter.

`rtpPortRule2`

This option selects the rule used for the port portion of the destination RTP channel allocation, when a DUT of the 'Virtual DUT' type is configured.

- 0 = Use same value (default)
- 1 = Use consecutive values (per port)
- 2 = Use consecutive values (per activity)
- 3 = Use same value for every x channels. Specify the value for x in `rtpPortRuleCh2`.

`rtpIpRuleCh2`

If `rtpIpRule2` is Use same value every, this specifies the number of channels having the same IP value.

`rtpPortRuleCh2`

If `rtpPortRule2` is Use same value every, this parameter specifies the number of channels having the same port value.

`symDestStr`

String identifying the VoIP No Call Control Peer that is the destination for traffic from this activity.  
Default="None".

**EXAMPLE**

```
$Activity_VoIPNoCCPeer1 agent.pm.dialPlan.config \  
-rtpIpRuleCh2          1 \  
-rtpPortRuleCh2       1 \  
-symDestStr            "Traffic2_VoIPNoCCPeer2:[10000-65535,4]" \  
-rtpIpRule2            1 \  
-rtpPortRule2         0
```

**SEE ALSO**

## Codec Settings

VoIP No Call Control Peer Codec Settings

### SYNOPSIS

```
$Activity_VoIPNoCCPeer1 agent.pm.codecSettings.config \  
-optionvalue
```

```
$Activity_VoIPNoCCPeer1 agent.pm.codecSettings.codecs.appendItem \  
-optionvalue
```

```
$Activity_VoIPNoCCPeer1 agent.pm.codecSettings.dataCodecs.appendItem \  
-optionvalue
```

### DESCRIPTION

Codec Settings contains the list of codecs that will be used by the VoIP No Call Control peers in the test. Codec Settings defines a video codec and configures a list of one or more codec (audio codec) or dataCodec objects. To add codec or dataCodec objects, use the appendItem command.

### SUBCOMMANDS

None.

### OPTIONS

videoPayloadType

This option selects the type of the video payload, in case video traffic is generated. In the current implementation, this is always '96'.

codecs\_number

This option selects the type of the video codec used, in case video traffic is generated. In the current implementation, this is always '0', which corresponds to the H.264 video codec.

### EXAMPLE

See the examples for Data Codecs and Codecs, as well as the following example:

```
$Activity_VoIPNoCCPeer1 agent.pm.codecSettings.config \  
-videoPayloadType          96 \  
-codecs_number             0
```

### SEE ALSO

[Data Codecs](#)

[Codecs](#)



## Codecs

VoIP No Call Control Peer Audio Codec

### SYNOPSIS

```
$Activity_VoIPNoCCPeer1 agent.pm.codecSettings.codecs.appendItem \  
-optionvalue
```

### DESCRIPTION

Codecs configures an audio codec object, which is added to the `Codec Settings` list of codecs.

### SUBCOMMANDS

None.

### OPTIONS

`id`

The audio codec type, one of the following:

Codec	Description
CodecAMR	Adaptive multi-rate codec
CodecG711u	G.711 mu-law codec
CodecG711a	G.711 A-law codec
CodecG723x153	G.723.1 codec @ 5.3 kbps
CodecG723x163	G.723.1 codec @ 6.3 kbps
CodecG726x16	G.726 codec @ 16 Kbps
CodecG726x24	G.726 codec @ 24 Kbps
CodecG726x32	G.726 codec @ 32 Kbps
CodecG726x40	G.726 codec @ 40 Kbps
CodecG729A	G.729 Annex-A codec
CodecILBC	Internet Low Bit Rate Codec

## Options for CodecAMR

dPayloadIn

Incoming dynamic payload type. Default="98" min="0" max="127".

dPayloadOut

Outgoing dynamic payload type. Default="98" min="0" max="127".

frameSize

Bytes per frame. Must be one of the following: 14. Default=14.

payloadFormat

Payload format.

Value	Usage
0 (default)	Bandwidth-efficient format
1	Octet-aligned format

mode

Codec bit rate. One of the following:

Mode	Description
0 (default)	4.75 kbps
1	5.15 kbps
2	5.90 kbps
3	6.70 kbps
4	7.40 kbps
5	7.95 kbps
6	10.20 kbps
7	12.20 kbps

## Options for CodecG711u

dPayloadIn

Incoming dynamic payload type. Default="0" min="0" max="127".

dPayloadOut

Outgoing dynamic payload type. Default="0" min="0" max="127".

frameSize

Bytes per frame. Must be one of the following: 40, 80, 160, 240. Default=160.

### **Options for CodecG711a**

dPayloadIn

Incoming dynamic payload type. Default="8" min="0" max="127".

dPayloadOut

Outgoing dynamic payload type. Default="8" min="0" max="127".

frameSize

Bytes per frame. Must be one of the following: 40, 80, 160, 240. Default=160.

### **Options for CodecG723x153**

dPayloadIn

Incoming dynamic payload type. Default="4" min="0" max="127".

dPayloadOut

Outgoing dynamic payload type. Default="4" min="0" max="127".

frameSize

Bytes per frame. Must be one of the following: 20. Default=20.

### **Options for CodecG723x163**

dPayloadIn

Incoming dynamic payload type. Default="4" min="0" max="127".

dPayloadOut

Outgoing dynamic payload type. Default="4" min="0" max="127".

frameSize

Bytes per frame. Must be one of the following: 24. Default=24.

### **Options for CodecG723x163**

dPayloadIn



Incoming dynamic payload type. Default="4" min="0" max="127".

dPayloadOut

Outgoing dynamic payload type. Default="4" min="0" max="127".

frameSize

Bytes per frame. Must be one of the following: 24. Default=24.

### Options for CodecG726x16

dPayloadIn

Incoming dynamic payload type. Default="102" min="0" max="127".

dPayloadOut

Outgoing dynamic payload type. Default="102" min="0" max="127".

byteOrder

Byte order.

Option	Description
0 (default)	Big Endian
1	Little Endian

frameSize

Bytes per frame. Must be one of the following: 20, 40, 60. Default=20.

### Options for CodecG726x24

dPayloadIn

Incoming dynamic payload type. Default="103" min="0" max="127".

dPayloadOut

Outgoing dynamic payload type. Default="103" min="0" max="127".

byteOrder

Byte order.

Option	Description
0 (default)	Big Endian

1	Little Endian
---	---------------

frameSize

Bytes per frame. Must be one of the following: 30, 60, 90. Default=30.

### Options for CodecG726x32

dPayloadIn

Incoming dynamic payload type. Default="104" min="0" max="127".

dPayloadOut

Outgoing dynamic payload type. Default="104" min="0" max="127".

byteOrder

Byte order.

Option	Description
0 (default)	Big Endian
1	Little Endian

frameSize

Bytes per frame. Must be one of the following: 40, 80, 120. Default=40.

### Options for CodecG726x40

dPayloadIn

Incoming dynamic payload type. Default="105" min="0" max="127".

dPayloadOut

Outgoing dynamic payload type. Default="105" min="0" max="127".

byteOrder

Byte order.

Option	Description
0 (default)	Big Endian
1	Little Endian

frameSize

Bytes per frame. Must be one of the following: 50, 100, 150. Default=50.

## Options for CodecG729

dPayloadIn

Incoming dynamic payload type. Default="18" min="0" max="127".

dPayloadOut

Outgoing dynamic payload type. Default="18" min="0" max="127".

cbxFrameSize

Bytes per frame. Must be one of the following: 10, 20, 30, 40, 50, Custom. Default=10.

customFrameSize

If cbxFrameSize is Custom, this option configures the custom frame size. Default="120" min="10" max="200".

## Options for CodecILBC

dPayloadIn

Incoming dynamic payload type. Default="97" min="0" max="127".

dPayloadOut

Outgoing dynamic payload type. Default="97" min="0" max="127".

frameSize

Bytes per frame. Must be one of the following: 38, 50, Custom. Default=38.

## EXAMPLE

```
$Activity_VoIPNoCCPeer1 agent.pm.codecSettings.codecs.clear
```

```
$Activity_VoIPNoCCPeer1 agent.pm.codecSettings.codecs.appendItem \
```

```
-id"CodecG711u" \
```

```
-dPayloadOut0 \
```

```
-dPayloadIn0 \
```

```
-frameSize160
```

```
$Activity_VoIPNoCCPeer1 agent.pm.codecSettings.codecs.appendItem \
```

```
-id"CodecG711a" \
```

```
-dPayloadOut8 \
```

```
-dPayloadIn8 \
```

-frameSize160

**SEE ALSO**

[Codec Settings](#)

## Data Codecs

VoIP No Call Control Peer Data Codecs

### SYNOPSIS

```
$Activity_VoIPNoCCPeer1 agent.pm.codecSettings.dataCodecs.appendItem \
-optionvalue
```

### DESCRIPTION

Data Codecs configures a data codec object, which is added to the `Codec Settings` list of codecs.

### SUBCOMMANDS

None.

### OPTIONS

`id`

The data codec type, one of the following:

Codec	Description
Rtp2833Events	Named Events Payload format used for carrying DTMF digits and other line and trunk signals as events.
Rtp2833Tones	RTP Payload format that can represent tones consisting of one or more frequencies.

`dPayloadType`

Payload type used for RTP data packets. Default=(see table) min="96" max="127"

Codec	Default value for dPayloadType
Rtp2833Events	100
Rtp2833Tones	101

### EXAMPLE

```
$Activity_VoIPNoCCPeer1 agent.pm.codecSettings.dataCodecs.clear
```

```
$Activity_VoIPNoCCPeer1 agent.pm.codecSettings.dataCodecs.appendItem \
-id"Rtp2833Events" \
```

```
-dPayloadType100
```

```
$Activity_VoIPNoCCPeer1 agent.pm.codecSettings.dataCodecs.appendItem \
```

```
-id"Rtp2833Tones" \
```

```
-dPayloadType101
```

**SEE ALSO**

[Codec Settings](#)

## Audio Settings

VoIP No Call Control Peer audio settings

### SYNOPSIS

```
$Activity_VoIPNoCCPeer1 agent.pm.audioSettings.config \
```

### DESCRIPTION

The Audio Settings configure the VoIP No Call Control Peer audio settings.

### SUBCOMMANDS

None.

### OPTIONS

```
enableAudio
```

If selected, audio script functions are executed, otherwise they are skipped.

```
audioClip
```

The played audio clip file.

```
playTypeAudio
```

The mode in which the clip is played.

Value	Usage
0 (default)	The clip is played for clip duration or for the duration of the Talk Time parameter in the case of BHCA/CPS/LPS objectives.
1	The clip is played for a user-defined duration.

```
audioDurationUnit
```

The play duration unit, which can be milliseconds (0), seconds (1), minutes (2), or hours (3).

```
outputLevel
```

The output level of the played clip.

```
enableTosRtp
```

Enables use of TOS/DSCP. Use the `rtpTos` option to specify the TOS/DSCP value. Default= False

```
rtpTosVal
```

The Type of Service (TOS/DSCP) byte setting in the sent RTP packets has one of the following values:

- Best Effort (0x00): Routine service

- Class 1 (0x20): Priority service, Assured Forwarding class 1
- Class 2 (0x40): Immediate service, Assured Forwarding class 2
- Class 3 (0x60): Flash, Assured Forwarding class 3
- Class 4 (0x80): Flash-override, Assured Forwarding class 4
- Express Forwarding (0xA0): Critical-ecp
- Control (0xC0): Internet-control
- Custom: A user-specified value.

useMOS

Enables the computation of MOS scores. Default= False.

enableAudioOWD

If true, IxLoad computes the One-way Delay metric, a network measurement specifying the amount of time (in ms) that a packet has spent on the network before it was received on the destination side. Default= False

useJitter

If true, enables use of a jitter buffer. Default= False.

jitMs

If useJitter is 1, this option configures the size of the jitter buffer, in milliseconds. Default="20" min="1" max="3000".

useJitComp

If true, enables dynamic modification of the jitter buffer size. Default= False.

jitCMs

If useJitComp is 1, this option configures the maximum size in of the jitter buffer, in milliseconds. Default="1000" min="0" max="3000".

jitCMaxDrop

If useJitComp is 1, this option configures the condition - a maximum number of consecutive packets dropped - that determines the jitter buffer size to be increased.

enableQoV

If true, this enables QoV P.862 PESQ and P.56 QoV computation. Default= False.

channelTypeQoV

When enableQoV is true, this specifies the objective type as either of the following:

- Number of channels (0)
- Percentage (1)

valueQoV



When `enableQoV` is `true`, this specifies the number of channels for which PESQ and P.56 QoV metrics are computed (when `channelTypeQoV` is 0). Alternatively this represents the percentage of channels for which PESQ and P.56 QoV metrics are computed (when `channelTypeQoV` is 1).

`unitsQoV`

The channels selection mode, which can be any of the following:

- First channels (0)
- Last channels (1)
- Evenly-spaced channels (2)
- Random (3)

`metricsQoV`

When `enableQoV` is `true`, this specifies the metric that is calculated by the Zion card. Available options are:

- PESQ and P.56 (0)
- PESQ (1)
- P56 (2)

`useSilence`

If `true`, RTP packets containing artificial background noise are sent when no other media (DTMF, MF, real payload, and so on) is sent over the communication channel. `Default= False`.

`silenceMode`

If `useSilence` is 1, this option configures the silence mode.

Value	Usage
0	Null data encoded
1 (default)	Comfort noise.

`enableAudioOWD`

If enabled, the One-way Delay metric is computed, a network measurement specifying the amount of time (in ms) that a packet has spent on the network before it was received on the destination side.

`Default = disabled`.

## EXAMPLE

```
$Activity_VoIPNoCCPeer1 agent.pm.audioSettings.config \-enableAudio
true \-audioClip                "US_042.wav" \-playTypeAudio
0 \-audioDurationUnit           1 \-audioDuration
10 \-outputLevel                -20 \-enableAudioOWD
false \-enableTosRtp            false \-rtpTosVal
32 \-useMos                     false \-useJitter
false \-jitMs                   20 \-useJitComp
```

```
false \-jitCMs                1000 \-jitCMaxDrop
7 \-enableQoV                 false \-channelTypeQoV
0 \-valueQoV                  100 \-unitsQoV
0 \-activityIdQoV             0 \-metricsQoV
0 \-useSilence                false \-silenceMode
1 \
```

**SEE ALSO**

## Video Settings

VoIP No Call Control Peer Video Settings

### SYNOPSIS

```
$Activity_VoIPNoCCPeer1 agent.pm.VideoSettings.config \  
-optionvalue
```

### DESCRIPTION

Video Settings configures the VoIP No Call Control Peer's video settings.

### SUBCOMMANDS

None.

### OPTIONS

`enableVideo`

Enables use of video as media traffic.

- 0 = disabled (default)
- 1 = enabled

`videoClip`

Name of the video file. Default = "Fire\_avc.mp4"

`playTypeVideo`

Determines parameters for running video. Following values are available:

Value	Usage
0 (default)	Play for clip duration
1	Play for specified duration.
2	Conference mode

`videoDuration`

If `playTypeVideo = 1`, determines duration of video. Maximum value = 259200000.

`videoDurationUnit`

Unit of duration. Following values are available:

Value	Usage
-------	-------

0	milliseconds
1	seconds
2	minutes
3	hours

useConference

If `playTypeVideo = 2`, enables use of conference mode. Following values are available:

Value	Usage
0	All speak
1	Sequential
2	Random

confVideoDuration

If `playTypeVideo = 2`, enables selection of the conference video duration.

confVideoDurationUnit

If `playTypeVideo = 2`, enables selection unit of conference video duration. The following values are available:

Value	Usage
0	milliseconds
1	seconds
2	minutes
3	hours

confDuration

If `playTypeVideo = 2`, enables selection of the conference audio duration.

confDurationUnit

If `playTypeVideo = 2`, enables selection unit of conference audio duration. The following values are available:

Value	Usage
-------	-------

0	milliseconds
1	seconds
2	minutes
3	hours

`enableTosVideo`

Enables use of TOS/DSCP. Use the `tosVideo` option to specify the TOS/DSCP value.

`tosVideo`

The following values are available:

Value	Usage
0	Best Effort (0x00)"
1	Class 1 (0x20)
2	Class 2 (0x40)
3	Class 3 (0x60)
4	Class 4 (0x80)
5	Express Forwarding (0xA0)
6	Control (0xC0)
7	Custom

`useMosVideo`

Enables computation of MOS.

0 = disabled (default)

1 = enabled

**Note:** If MOS computation is enabled, the `enableVideoOWD` option also has to be enabled.

`enableVideoOWD`

If enabled, the One-way Delay metric is computed, a network measurement specifying the amount of time (in ms) that a packet has spent on the network before it was received on the destination side.

Default = disabled.

`ignoreHintTrack`

If enabled, the hint track present in the video clip is ignored. The video streaming uses a new hint track which is recreated using one of the packetization modes defined by `hintTrackType`. By default it is disabled.

`hintTrackType`

Allows to select the packetization mode. The following values are available:

Value	Usage
0 (default)	Single NAL Unit
1	STAP-A, with FU-A fragmentation

### EXAMPLE

```
$Activity_VoIPNoCCPeer1 agent.pm.videoSettings.config \-rotationScheme
0 \-confDuration 1 \-useMosVideo
false \-enableVideoOWD false \-ignoreHintTrack
false \-enableTosVideo true \-enableVideo
true \-videoClip "Fire_avc.mp4" \-
useH323AdvancedSettings false \-videoDuration
5 \-confVideoDurationUnit 1 \-useConference
false \-confDurationUnit 1 \-confVideoDuration
1 \-videoDurationUnit 1 \-hintTrackType
1 \-fmt " \-rtpmap
" \-playTypeVideo 0 \-tosValVideo
32
```

### SEE ALSO

## T.30 Settings

VoIP No Call Control Peer T.30 Settings

### SYNOPSIS

```
$Activity_VoIPNoCCPeer1 agent.pm.t30parameters.config \  
-optionvalue
```

### DESCRIPTION

T.30 Settings configures the VoIP No Call Control Peer's fax T.30 settings.

### SUBCOMMANDS

None.

### OPTIONS

t30StationId

The fax station's identifier sent in CSI, TSI and CIG. Required valid station ID or sequence generator expression (e.g. '5551[000-]'). Default = "5551[000-]"

t30SendCoding

The highest coding scheme available to compress the page data when sending. The following values are available:

Value	Usage
0	MH
1	MR
2 (Default)	MMR

t30SendDataRate

The data rate for sending. The following values are available:

Value	Usage
0	V.27 ter 2.4
1	V.27 ter 4.8
2	V.17 7.2

3	V.17 9.6
4	V.17 12
5(default)	V.17 14.4
6	V.29 7.2
7	V.29 9.6
8	V.34 16.8
9	V.34 19.2
10	V.34 21.6
11	V.34 24
12	V.34 26.4
13	V34 28.8
14	V.34 31.2
15	V34 33.6

t30SendPageSize

The page size for sending. The following values are available:

Value	Usage
0	A4 (210x297 mm)
1	B4 (255x364 mm)
2	A3 (297x420 mm)

t30SendMSLT

The minimum transmission time of one coded scan line. Default = 0

The following values are available:

Value	Usage
0 (default)	Auto (based on DIS)
1	5 ms T7.7 = T3.85



2	10 ms T7.7 = 1/2 T3.85
3	10 ms T7.7 = T3.85
4	20 ms T7.7 = 1/2 T3.85
5	20 ms T7.7 = T3.85
6	40 ms T7.7 = 1/2 T3.85
7	40 ms T7.7 = T3.85

t30SendProtocol

The protocol used for fax sending. The following values are available

Value	Usage
0	non-ECM
1 (default)	ECM.

t30SendResolution

The horizontal and vertical resolution of the page image. The following values are available

Value	Usage
0 (default)	R8x3.85 lines/mm
1	R8x7.7 lines/mm
2	R8x15.4 lines/mm
3	200x200 dots/inch

sendCNG

If enabled, CNG message is sent.

t30ReceiveCoding

The highest coding scheme available to compress the page data when receiving. The following values are available:

Value	Usage
0	MH

1	MR
2 (Default)	MMR

t30ReceivePageSize

The page size for receiving. The following values are available:

Value	Usage
0	A4 (210x297 mm)
1	B4 (255x364 mm)
2 (default)	A3 (297x420 mm)

t30ReceiveMSLT

The minimum transmission time of one coded scan line. Default = 0

The following values are available:

Value	Usage
0 (default)	0 ms T7.7 = T3.85
1	5 ms T7.7 = T3.85
2	10 ms T7.7 = 1/2 T3.85
3	10 ms T7.7 = T3.85
4	20 ms T7.7 = 1/2 T3.85
5	20 ms T7.7 = T3.85
6	40 ms T7.7 = 1/2 T3.85
7	40 ms T7.7 = T3.85

t30ReceiveProtocol

The protocol used for fax receiving. The following values are available:

Value	Usage
0	non-ECM
1 (default)	ECM.

sendCedBeforeDIS

If enabled, allows the answering fax to send a CED (called station Id) signal.

t30ReceiveModulations

Allows to select the receiving protocol. The following values are available:

Value	Usage
0	V.27
1 (default)	V.27/V.29
2	V.27/V.29/V.17
3	V.27/V.29/V.17/V.34

t30ReceiveR8x3

If enabled, receive resolution is R8x3.85 lines/mm.

t30ReceiveR8x7

If enabled, receive resolution is R8x7.7 lines/mm.

t30ReceiveR8x15

If enabled, receive resolution is R8x15.4 lines/mm.

t30Receive200x200

If enabled, receive resolution is 200x200 dots/inch.

## EXAMPLE

```
$Activity_VoIPNoCCPeer1 agent.pm.t30Parameters.config \
```

```
-t30SendResolution          0 \
-sendCedBeforeDIS          1 \
-t30ReceiveR8x7            true \
-t30SendPageSize           0 \
-t30ReceiveR8x3            true \
-t30SendProtocol           1 \
-t30ReceiveProtocol        1 \
-sendCNG                    1 \
-t30SendCoding              0 \
```

```
-t30ReceiveMSLT          0 \  
-t30SendMSLT             0 \  
-t30ReceiveCoding        2 \  
-t30ReceivePageSize      2 \  
-t30ReceiveModulations   3 \  
-t30ReceiveR8x15         true \  
-t30StationId            "5551\[000-\  
-t30SendDataRate         5 \  
-t30Receive200x200      true
```

**SEE ALSO**

## T.38 Settings

VoIP No Call Control Peer T.38 Settings

### SYNOPSIS

```
$Activity_VoIPNoCCPeer1 agent.pm.t38Settings.config \  
-optionvalue
```

### DESCRIPTION

T.38 Settings configures the VoIP No Call Control Peer's fax T.38 settings.

### SUBCOMMANDS

None.

### OPTIONS

enableT38

Enables use of 'T.38 Fax Session' script function.

0 = disabled (default)

1 = enabled

t38Port

The T.38 listening port. Default = "40000". This parameter specifies a valid port (1000-65535) or simple sequence generator expression (e.g. [1000-2000,2])

faxImage

Fax image to be sent. Default = "Ixia2Pages.tif"

t38TransportType

The transport protocol used for carrying the T.38 traffic. Default = "1"

The following values are available

Value	Usage
0	TCP
1	UDP

t38UdpEncapsulation

If t38TransportType = 1, t38UdpEncapsulation defines the protocol used to encapsulate T.38 messages. The following values are available:

Value	Usage
0	UDPTL
1	RTP

`t38PayloadType`

The payload type identifier. Minimum = 0, Maximum = 127, and Default = 102

`useFaxVersion`

If enabled, allows selecting the T.38 protocol version.

`faxVersion`

If **useFaxVersion** is enabled, used to identify the T.38 protocol version, 0, 1, 2, or 3 (default = 0).

`useT38MaxBitrate`

If enabled, allows selecting the maximum fax transmission rate.

`t38MaxBitrate`

The maximum fax transmission rate supported by the endpoint (default = 5). The following values are allowed:

Value	Usage
0	2.4 kbps
1	4.8 kbps
2	7.2 kbps
3	9.6 kbps
4	12 kbps
5 (default)	14.4 kbps
6	16.8 kbps
7	19.2 kbps
8	21.6 kbps
9	24 kbps
10	26.4 kbps

11	28.8 kbps
12	31.2 kbps
13	33.6 kbps

useT38RateMgmt

If enabled, allows selecting the fax rate management model.

t38RateMgmt

The fax rate management model as defined in T.38. Following values are allowed:

Value	Usage
0	Transferred TCF
1	Local TCF

useErrorRecoverySchema

If enabled, allows selecting the desired error correction scheme.

errorRecoverySchema

The desired error correction scheme. The following values are allowed:

Value	Usage
0 (default)	Redundancy
1	FEC

useT38MaxDatagramSize

If enabled, allows selecting the maximum datagram size.

t38MaxDatagramSize

The maximum datagram size (default = 256), which represents the maximum number of bytes that can be stored on the remote device before an overflow condition occurs. Minimum = 0, Maximum = 256.

### EXAMPLE

```
$Activity_VoIPNoCCPeer1 agent.pm.t38Settings.config \-enableT38
true \-t38TranscodingMMR                false \-t38UdpEncapsulation
0 \-useT38MaxBitrate                    true \-t38RateMgmt
0 \-t38TranscodingJBIG                  false \-t38TransportType
1 \-t38Port                              "40000" \-t38FillBitRemoval
0 \-faxVersion                          0 \-useT38FillBitRemoval
```

```
false \-useT38RateMgmt                true \-faxImage
"Ixia2Pages.tif" \-useT38MaxBufferSize  false \-
errorRecoverySchema                    0 \-t38MaxDatagramSize
256 \-t38MaxBufferSize                 200 \-useFaxVersion
true \-useT38MaxDatagramSize           true \-t38MaxBitrate
5 \-t38PayloadType                     102 \-useErrorRecoverySchema
true
```

**SEE ALSO**



## RTP Settings

VoIP No Call Control Peer RTP Settings

### SYNOPSIS

```
$Activity_VoIPNoCCPeer1 agent.pm.rtpSettings.config \  
-optionvalue
```

### DESCRIPTION

RTP Settings configures the VoI PNo Call Control Peer RTP transport settings.

### SUBCOMMANDS

None.

### OPTIONS

```
enableRTP
```

Enables use of RTP to transport the media traffic.

0 = disabled (default)

1 = enabled

```
rtpPort
```

RTP port number. Default="10000".

**Note:** Valid port numbers are between 1000 and 65534.

```
enableRTCP
```

Enables the sending and receiving of RTCP packets.

```
chEnableHwAcc
```

If true, enables hardware acceleration for RTP traffic. Default=false.

```
enableAdvStatCalc
```

Enables the computation of advanced RTP statistics.

```
enablePerStream
```

Enables computation of per-stream statistics.

```
enableMDI
```

Enables computation of MDI DF and MDI MLR statistics.

```
enableNBExec
```

If `true`, all RTP functions from a scenario execute in a non-blocking mode, i.e the current function from a channel executes in the background, allowing the execution to continue on that channel with the next script function. Default= `False`.

**EXAMPLE**

```
$Activity_VoIPNoCCPeer1 agent.pm.rtpSettings.config \-enableRTP
true \-enableRTCP false \-enableMDI
false \-chEnableHwAcc true \-chDisableHwAcc
false \-enableAdvStatCalc false \-enablePerStream
false \-rtpPort "[10000-65535,4]" \-enableNBExec
false
```

**SEE ALSO**

## SRTP Settings

VoIP No Call Control Peer SRTP Settings

### SYNOPSIS

```
$Activity_VoIPNoCCPeer1 agent.pm.srtpSettings.config \
-optionvalue
```

### DESCRIPTION

SRTP Settings configures the VoIP No Call Control Peer's SRTP settings.

### SUBCOMMANDS

None.

### OPTIONS

benableRTP

Enables use of SRTP to transport the media traffic.

- false = disabled (default)
- true = enabled

bDisableSRTPAuthentication

If true, this option disables SRTP authentication.

bDisableSRTPEncryption

If true, this option disables SRTP stream encryption.

bIncludeMKI

If true, the generated SRTP packets include the MKI field.

bDisableValidations

If true, none of the validations below are performed on the received SRTP packets:

- SRTP packet authentication tag is not verified
- Master Key expiration is not verified
- SRTP packet MKI field is ignored

bDisableSRTCPEncryption

If true, this option disables SRTCP stream encryption.

bAllowOnlySecureStreams

If true, the SDP offer comprises only secure streams and SDP negotiates only secure streams.

bDisableMasterSalt

If true, the Master Salt value is null instead of it being randomly generated.

bStaticMasterKeySalt

If true, this option determines the use of a static master key and salt.

\_masterKeySelection

Specifies if a single key or multiple keys are used:

- 0 = A single key is used. The key is specified by the `staticSingleKeySalt` parameter.
- 1 = Multiple static keys are used. Keys are obtained from a file specified by the `staticKeyFile` parameter.

staticSingleKeySalt

If `bStaticMasterKeySalt` is true, this parameter defines a key value.

staticKeyFile

If `bStaticMasterKeySalt` is true, this parameter defines a file containing multiple key values.

### EXAMPLE

```
$Activity_VoIPNoCCPeer1 agent.pm.srtpSettings.config \-bDisableSRTPAuthentication
false \-bIncludeMKI true \-bEnableSRTP
true \-bDisableValidations false \-bDisableSRTCPEncryption
false \-bStaticMasterKeySalt true \-bAllowOnlySecureStreams
false \-bDisableMasterSalt false \-staticSingleKeySalt
"BjVFszwVXnYB2Rtr6BbFfbvDkuFtUjJWUCClq4gP" \-staticKeyFile
"" \-bDisableSRTCPEncryption false \-_masterKeySelection
0
```

### SEE ALSO

## Other Settings

VoIP No Call Control Peer Other Settings

### SYNOPSIS

```
$Activity_VoIPNoCCPeer1 agent.pm.otherSettings.config \  
-optionvalue
```

### DESCRIPTION

This object configures the VoIP No Call Control Peer activity's miscellaneous options.

### SUBCOMMANDS

None.

### OPTIONS

VOIP\_Var0

The VOIP\_Var1...VOIP\_Var5 and VOIP\_IPAddr1...VOIP\_IPAddr5 string-type variables supporting generator expressions enable you to generate 10 series of global variables whose values are used at runtime by the simulated endpoints/channels. `Default=""`.

Use the VOIP\_Var1...VOIP\_Var5 variables to represent phone numbers, and the VOIP\_IPAddr1...VOIP\_IPAddr5 to represent IP addresses.

VOIP\_Var1

See VOIP\_Var0.

VOIP\_Var2

See VOIP\_Var0.

VOIP\_Var3

See VOIP\_Var0.

VOIP\_Var4

See VOIP\_Var0.

VOIP\_IPAddress0

See VOIP\_Var0.

VOIP\_IPAddress1

See VOIP\_Var0.

VOIP\_IPAddress2

See VOIP\_Var0.

VOIP\_IPAddress3

See VOIP\_Var0.

VOIP\_IPAddress4

See VOIP\_Var0.

ipPreference

Type of addressing you want to use on the subnet that the VOIP No Call Control Peer runs on.

Value	Usage
0 (default)	IPv4
1	IPv6

### EXAMPLE

```
$Activity_VoIPNoCCPeer1 agent.pm.otherSettings.config \  
-ipPreference0 \  
-VOIP_Var1"" \  
-VOIP_Var0"" \  
-VOIP_Var3"" \  
-VOIP_Var2"" \  
-VOIP_Var4"" \  
-VOIP_IPAddress4"" \  
-VOIP_IPAddress1"" \  
-VOIP_IPAddress0"" \  
-VOIP_IPAddress3"" \  
-VOIP_IPAddress2""
```

### SEE ALSO

| B

## IP, TCP, Run State, and Curve Segment L2/L3, and Port CPU Statistics

Statistics in the results files and reports are averaged over all ports. If a statistic for an interval is missing, IxLoad interpolates it from the statistic immediately prior to it and the statistic after it.

For the per-Interface and TCP statistics, see [Per-Interface and TCP Statistics](#).

For the Run State statistics, see [Run State Statistics](#).

For the Curve Segment statistics, see [Curve Segment Statistics](#).



### Notes:

- IxLoad increments its TCP statistics at the time it causes a TCP packet to be generated. If a lower layer process in the TCP stack fails to transmit a packet, IxLoad does not update its statistics accordingly.
- If a process sends a SYN to the server port to which there is no corresponding listening socket, the Ixia port stack generates an RST, and the IxLoad will be unaware of the RST.

## Per-Interface and TCP Statistics

The TCP statistics are displayed by most of IxLoad's protocols in their statistics views in StatViewer. In the first table below, *Caption* is the label shown in StatViewer for a statistic. *Name* is the name of the statistic as it appears in the Stats Catalog. To make queries from the API, you must use a statistic's name.

For the per-Interface and TCP statistics see the following:

[Per-Interface Statistics](#)

[TCP Statistics](#)



## TCP Statistics

The following TCP statistics are available for some, but not all, protocols and are published on a per-protocol basis, not on a per-interface basis. At the time of printing, the following protocols do not support TCP statistics:

Radius	WAP
TFTP	Trace File Replay
DHCP	

To confirm that TCP statistics are available, configure a test in the GUI, refresh the stat views, and then display the list of statistics in the view editor. If TCP statistics are listed, the protocol supports them.

FTP displays TCP statistics separately for the control and data connections. For the list of TCP statistics captions displayed in the FTP statistics views, see [FTP Captions for TCP Statistics](#).

The table below describes the TCP statistics.

Statistic	Description
TCP Simulated Users	Number of simulated users.
Physical Rx Drops	Number of incoming packets dropped due to buffer overflow.
Physical Tx Drops	Number of outgoing packets dropped due to buffer overflow. Typically, this is caused by stopping a large test or configuring a Ramp Down time that is too short.
TCP Connection Lifetime	Amount of time elapsed between the time the first SYN in the TCP connection handshake is received and the last FIN or ACK sent or the TCP connection. This statistic measures the total lifetime of a connection through all three major stages of the connection: handshake duration + data transfer duration + close duration.
SYNs Sent (caption) TCP SYN Sent (name)	Number of connection requests (SYNs) sent. Only the initial SYN sent is counted in this statistic; retried SYNs are not included. Retried SYNs are counted in the TCP Retries statistic..

SYNs Received (caption) TCP SYN Received (name)	Number of connection requests (SYNs) received.
SYN/SYN-ACKs Received (caption) TCP SYN_SYN-ACK Received (name)	Number of connection requests (SYNs) and connection request acknowledgments (SYN and ACK flags set) received.
TCP SYN Failed	Number of connection requests (SYNs) sent for which a reset (RST) was received.
SYN-ACKs Sent (caption) TCP SYN-ACK Sent (name)	Number of connection request acknowledgments (SYN and ACK flags set) sent.
Connection Requests Failed (caption) TCP Connection Requests Failed (name)	Number of attempts to establish connections which did not result in connections being created.
TCP Connections Established	Number of connections established. <b>Note:</b> For a peer-to-peer protocol, this statistic counts the aggregate number of connections established, not the number established from the point of view of one side or the other.
FINs Sent (caption) TCP FIN Sent (name)	Number of connection termination requests (FINs) sent. Only the initial FIN sent is counted in this statistic; retried FINs are not included. Retried FINs are counted in the TCP Retries statistic.

FINs Received (caption) TCP FIN Received (name)	Number of connection termination requests (FINs) received.
FIN-ACKs Sent (caption) TCP FIN-ACK Sent (name)	Number of connection termination acknowledgments (FIN-ACK) sent. Only the initial FIN-ACK sent is counted in this statistic; retried FINs are not included. Retried FINs are counted in the TCP Retries statistic..
FIN-ACKs Received (caption) TCP FIN-ACK Received (name)	Number of connection termination acknowledgments (FIN-ACK) received.
Resets Sent (caption) TCP Resets Sent (name)	<p>Number of Resets (RST) sent for any reason.</p> <p>Under some scenarios, the number of RSTs may not match between the client and server.</p> <p>For example, an Abort following a request generates two RSTs. On the client side, when the first RST is sent, the socket context is destroyed and hence only one RST is included in the client's TCP stats. However, on the server, receiving the first RST doesn't destroy the socket context immediately and so the second RST received is the one that is updated.</p>
Resets Received (caption) TCP Resets Received (name)	Number of Resets (RST) received. Includes RSTs received as responses to SYNs and for any other reasons.
TCP Bytes Sent	Number of bytes sent in TCP packets.
TCP Bytes Received	Number of bytes received in TCP packets.
Retries (caption) TCP Retries (name)	Total number of retries attempted for all segments.

Timeouts (caption) TCP Timeouts (name)	Total number of timeouts that occurred for all segments.
Accept Queue Entries (caption) TCP Accept Queue Entries (name)	Number of entries in the listening socket's queue of connections awaiting acceptance.
Listen Queue Drops (caption) TCP Listen Queue Drops (name)	Number of incoming SYN packets dropped from the socket listen queue. An incoming SYN packet is held in a listen queue while the host replies with a SYN+ACK and waits for the confirming ACK (the three-way handshake). A listen queue in this state is called a half-open connection.
TCP Con- nections in ESTABLISHED State	Number of TCP connections in the ESTABLISHED state. A connection in the ESTABLISHED state can transfer data between the two ends in both directions.
TCP Con- nections in SYN-SENT State	Number of TCP connections in the SYN-SENT state. A client enters the SYN-SENT state after it has sent a SYN segment to the server to open a connection.
TCP Con- nections in SYN- RECEIVED State	Number of TCP connections in the SYN-RECEIVED state. A server enters the SYN-RECEIVED state after it receives a SYN from a client, requesting a connection. The server replies with a SYN+ACK segment.
TCP Con- nections in FIN-WAIT-1 State	Number of TCP connections in the FIN-WAIT-1 state. Sockets in the FIN-WAIT-1 state are closed and tearing down the connection.
TCP Con- nections in FIN-WAIT-2 State	Number of TCP connections in the FIN-WAIT-2 state. A connection in the FIN-WAIT-2 state has closed the local socket and is waiting for shutdown from the remote socket.

TCP Connections in TIME-WAIT State	Number of TCP connections in the TIME-WAIT state. A connection in the TIME-WAIT state has closed the local socket and is waiting for remote shutdown retransmission.
TCP Connections in CLOSE State	Number of TCP connections in the CLOSE state. A connection in the CLOSE state is closed.
TCP Connections in CLOSE-WAIT State	Number of TCP connections in the CLOSE-WAIT state. A connection in the CLOSE-WAIT state is waiting for the local socket to close after a remote shut down.
TCP Connections in LAST-ACK State	Number of TCP connections in the LAST-ACK state. A connection in the LAST-ACK state is performing a remote shutdown; it will close the connection and wait for the acknowledgment.
TCP Connections in LISTENING State	Number of TCP connections in the LISTENING state. A socket in the LISTENING state is listening for an incoming connection.
TCP Connections in CLOSING State	Number of TCP connections in the CLOSING state. A socket in the CLOSING state is closed, has performed a remote shutdown, and is waiting for the acknowledgment.

## FTP Captions for TCP Statistics

FTP displays TCP statistics separately for the control and data connections. For the list of TCP statistics captions displayed in the FTP statistics views, see the table below.

Statistic	Description
<b>TCP Statistics for Control Connections</b>	
Control SYNs Sent	Number of SYNs sent on control connections. See <i>SYNs Sent</i> in the <a href="#">TCP Statistics</a> table.

Control SYNs Received	Number of connection requests (SYNs) received on control connections. See <i>SYNs Received</i> in the <a href="#">TCP Statistics</a> table.
Control SYN/SYN-ACKs Received	Number of connection requests (SYNs) and connection request acknowledgements (SYN and ACK flags set) received on control connections. See <i>SYN/SYN-ACKs Received</i> in the <a href="#">TCP Statistics</a> table.
Control SYN-ACKs Sent	Number of connection request acknowledgements (SYN and ACK flags set) sent on control connections. See <i>SYN-ACKs Sent</i> in the <a href="#">TCP Statistics</a> table.
Control Connection Requests Failed	Number of attempts to establish control connections which did not result in connections being created. See <i>Connection Requests Failed</i> in the <a href="#">TCP Statistics</a> table.
Control FINs Sent	Number of connection termination requests (FINs) sent on control connections. See <i>FINs Sent</i> in the <a href="#">TCP Statistics</a> table.
Control FINs Received	Number of connection termination requests (FINs) received on control connections. See <i>FINs Received</i> in the <a href="#">TCP Statistics</a> table.
Control FIN-ACKs Sent	Number of connection termination acknowledgements (FIN-ACK) sent on control connections. See <i>FIN-ACKs Sent</i> in the <a href="#">TCP Statistics</a> table.
Control FIN-ACKs Received	Number of connection termination acknowledgements (FIN-ACK) received on control connections. See <i>FIN-ACKs Received</i> in the <a href="#">TCP Statistics</a> table.
Control Resets Sent	Number of Resets (RST) sent on control connections. See <i>Resets Sent</i> in the <a href="#">TCP Statistics</a> table.
Control Resets Received	Number of Resets (RST) received on control connections. See <i>Resets Received</i> in the <a href="#">TCP Statistics</a> table.
Control Retries	Total number of retries attempted on control connections for all segments. See <i>Retries</i> in the <a href="#">TCP Statistics</a> table.
Control Timeouts	Total number of timeouts that occurred on control connections for all segments. See <i>Timeouts</i> in the <a href="#">TCP Statistics</a> table.

Control Accept Queue Entries	Number of entries in the listening socket's queue of control connections awaiting acceptance. See <i>Accept Queue Entries</i> in the <a href="#">TCP Statistics</a> table.
Control Listen Queue Drops	Number of incoming SYN packets on control connections dropped from the socket listen queue. See <i>Listen Queue Entries</i> in the <a href="#">TCP Statistics</a> table.
<b>TCP Statistics for Data Connections</b>	
Data SYNs Sent	Number of SYNs sent on data connections. See <i>SYNs Sent</i> in the <a href="#">TCP Statistics</a> table.
Data SYNs Received	Number of connection requests (SYNs) received on data connections. See <i>SYNs Received</i> in the <a href="#">TCP Statistics</a> table.
Data SYN/SYN-ACKs Received	Number of connection requests (SYNs) and connection request acknowledgements (SYN and ACK flags set) received on data connections. See <i>SYN/SYN-ACKs Received</i> in the <a href="#">TCP Statistics</a> table.
Data SYN-ACKs Sent	Number of connection request acknowledgements (SYN and ACK flags set) sent on data connections. See <i>SYN-ACKs Sent</i> in the <a href="#">TCP Statistics</a> table.
Data Connection Requests Failed	Number of attempts to establish data connections which did not result in connections being created. See <i>Connection Requests Failed</i> in the <a href="#">TCP Statistics</a> table.
Data FINs Sent	Number of connection termination requests (FINs) sent on data connections. See <i>FINs Sent</i> in the <a href="#">TCP Statistics</a> table.
Data FINs Received	Number of connection termination requests (FINs) received on data connections. See <i>FINs Received</i> in the <a href="#">TCP Statistics</a> table.
Data FIN-ACKs Sent	Number of connection termination acknowledgements (FIN-ACK) sent on data connections. See <i>FIN-ACKs Sent</i> in the <a href="#">TCP Statistics</a> table.
Data FIN-ACKs Received	Number of connection termination acknowledgements (FIN-ACK) received on data connections. See <i>FIN-ACKs Received</i> in the <a href="#">TCP Statistics</a> table.

Data Resets Sent	Number of Resets (RST) sent on data connections. See <i>Resets Sent</i> in the <a href="#">TCP Statistics</a> table.
Data Resets Received	Number of Resets (RST) received on data connections. See <i>Resets Received</i> in the <a href="#">TCP Statistics</a> table.
Data Retries	Total number of retries attempted on data connections for all segments. See <i>Retries</i> in the <a href="#">TCP Statistics</a> table.
Data Timeouts	Total number of timeouts that occurred on data connections for all segments. See <i>Timeouts</i> in the <a href="#">TCP Statistics</a> table.
Data Accept Queue Entries	Number of entries in the listening socket's queue of data connections awaiting acceptance. See <i>Accept Queue Entries</i> in the <a href="#">TCP Statistics</a> table.
Data Listen Queue Drops	Number of incoming SYN packets on data connections dropped from the socket listen queue. See <i>Listen Queue Entries</i> in the <a href="#">TCP Statistics</a> table.



## Advanced TCP Statistics

The following TCP statistics are available if you check the Enable TCP Advanced Stats option on the Test Options window. (see Test Options). These statistics will be present in the CSV when the option is enabled, and you can create a custom view in the Statistics Viewer with these statistics, if required.

The table below describes the Advanced TCP statistics.

Statistic	Description
TCP Lost Retransmits	Retransmissions for segments that have not been acknowledged.
TCP Fast Retransmits	Retransmissions that occurred before the retransmission timer expired because the other side sent three ACKs for the same segment.
TCP Forward Retransmits	<p>Number of segments retransmitted even though there was no indication that they were actually lost.</p> <p>Retransmission stopped when either of the following occurs:</p> <ul style="list-style-type: none"> <li>• The maximum time to wait for a remote response is reached. This timeout occurs when the total time of all retransmission intervals exceeds the maximum time to wait for a remote response.</li> <li>• The number of retransmissions configured in maximum retransmissions per packet is reached.</li> </ul> <p>Forward Retransmits occur only on SACK-negotiated connections.</p>
TCP Slow Start Retransmits	Retransmissions during the Slow Start phase.
TCP Local Advertisement Window	Window size advertised by the local side.
TCP Remote Advertisement Window	Window size advertised by the remote side.
TCP Syn-Syn-Ack Time	Average time elapsed between the time the SYN was sent and the SYN-ACK was received.
TCP Syn-Syn-Ack Time Squared	Variation in the TCP Syn-SynAck Time.

## Per-Interface Statistics

The table below describes the per-Interface statistics.

Statistic	Description
Packets Sent	Number of IP packets sent.
Packets Received	Number of IP packets received.
Bytes Sent	Number of bytes sent in IP packets.
Bytes Received	Number of bytes received in IP packets.
Fragments Received	Number of IP packet fragments received. <b>Note:</b> When a Stateless Peer activity is configured, the Fragments Received statistic is updated only if, on the receiving side, either the <i>Send Timestamp</i> or <i>Enable Out of Order</i> setting is enabled (on the Stateless Peer Settings, Advanced Options tab).
Reassembly Timeouts	Number of fragmented IP packets that could not be reassembled within the timeout period.

## Run State Statistics

The Run State statistics (see the table below) identify the phase that the test is in at a given time. The Run State statistics are stored in the CSV files, and can be retrieved using the IxLoad Tcl API.

To retrieve Run State statistics, use the same syntax as for any other statistic. However, if you are retrieving a list of statistics, the Run State statistics must be first in the list, ahead of any other type of statistics.

For examples of how to retrieve Run State statistics, see the `HTTP_StateStats.tcl` or `HTTP_StateStats_SM.tcl` sample scripts in the `<install path>\TclScripts\Samples\Stats` directory).

There are different Run States for Basic timelines and for Advanced timelines.

Run State	Description
<b>Basic Timeline</b>	
ID	Idle
RU	Ramp Up
SU	Sustain
RD	Ramp Down
<b>Advanced Timeline</b>	
ID	Idle
LR	Linear segment
LU	Linear segment, Upwards
LD	Linear segment, Downwards
LI	Linear segment, Idle
ST	Steps segment, Upwards
SD	Steps segment, Downwards
BU	Bursts segment
BR	Bursts segment, Right skew
BL	Bursts segment, Left skew
PU	Pulses segment

PO	Poisson segment
----	-----------------

## Curve Segment Statistics

In a test that uses an Advanced timeline, the Curve Segment statistics identify the segment that is active at a given time. The Curve Segment statistics are stored in the CSV files, and can be retrieved using the IxLoad Tcl API.

Curve Segments are numbered starting with 0 (zero), and continuing through the *n*th segment. Segment 0 is the segment during which test initialization occurs; no traffic is sent during segment 0. For a Basic timeline, the Curve Segment is always 0.

## Connection Latency Statistics

The table below describes the connection latency statistics.

Statistic	Description
Connection Latency 0 - 10 $\mu$ sec	Number of connections established after a delay of 0 to 10 microseconds.
Connection Latency 10 - 20 $\mu$ sec	Number of connections established after a delay of 10 to 20 microseconds.
Connection Latency 20 - 30 $\mu$ sec	Number of connections established after a delay of 20 to 30 microseconds.
Connection Latency 30 - 40 $\mu$ sec	Number of connections established after a delay of 30 to 40 microseconds.
Connection Latency 40 - 50 $\mu$ sec	Number of connections established after a delay of 40 to 50 microseconds.
Connection Latency 50 - 60 $\mu$ sec	Number of connections established after a delay of 50 to 60 microseconds.
Connection Latency 60 - 70 $\mu$ sec	Number of connections established after a delay of 60 to 70 microseconds.
Connection Latency 70 - 80 $\mu$ sec	Number of connections established after a delay of 70 to 80 microseconds.
Connection Latency 90 - 100 $\mu$ sec	Number of connections established after a delay of 90 to 100 microseconds.
Connection Latency 100 - 200 $\mu$ sec	Number of connections established after a delay of 100 to 200 microseconds.
Connection Latency 200 - 300 $\mu$ sec	Number of connections established after a delay of 200 to 300 microseconds.
Connection Latency 300 - 400 $\mu$ sec	Number of connections established after a delay of 300 to 400 microseconds.
Connection Latency 400 - 500 $\mu$ sec	Number of connections established after a delay of 400 to 500 microseconds.
Connection Latency 500 - 600 $\mu$ sec	Number of connections established after a delay of 500 to 600 microseconds.

Connection Latency 600 - 700 $\mu$ sec	Number of connections established after a delay of 600 to 700 microseconds.
Connection Latency 700 - 800 $\mu$ sec	Number of connections established after a delay of 700 to 800 microseconds.
Connection Latency 800 - 900 $\mu$ sec	Number of connections established after a delay of 800 to 900 microseconds.
Connection Latency 900 - 1000 $\mu$ sec	Number of connections established after a delay of 900 to 1000 microseconds.
Connection Latency > 1000 $\mu$ sec	Number of connections established after a delay of over 1000 microseconds.

## IxServer Layer 2-3 Statistics

The table below describes the Layer 2 and 3 IxServer statistics available in IxLoad.

In the IxLoad GUI, IxServer statistics are displayed in separate views for client/peer and server ports. The views appear automatically in the top-level statistics views. Each view column (except for the Link State and Line Speed statistics) has a summary footer value showing the cumulative values for all ports in the view.



### Notes:

- If you aggregate 1G and 10G ports, no ARP stats are displayed.
- If you aggregate 10G ports, only statistics from port 13 are displayed.

Statistic	Description
Bits Received Rate (Kb/s)	Rate at which bits are being received.
Bits Sent Rate (Kb/s)	Rate at which bits are being transmitted.
Bytes Received	Total number of bytes received.
Bytes Sent	Total number of bytes transmitted.
Frames Sent	Number of frames successfully transmitted. This statistic does not include frames retransmitted due to collisions.
Frames Sent Rate	Rate at which frames are being transmitted. This statistic does not include frames retransmitted due to collisions.
Line Speed	For Ethernet load modules, this statistic indicates the speed, in Mbps, negotiated on the link. For POS modules, this statistic indicates the POS level: OC-3, OC-12, or OC-48
Link State	Connectivity on the link. This statistic can be one of the following values: <b>Up:</b> A link is established with another device. <b>Loopback:</b> The port has loopback enabled. <b>Down:</b> There is no connection to another device.



Receive Arp Reply	Number of ARP replies received.
Receive Arp Request	Number of ARP requests received.
Transmit Arp Reply	Number of ARP replies sent.
Transmit Arp Request	Number of ARP requests sent.
Valid Frames Received	<p>Number of valid frames received.</p> <p>A valid frame is a frame that is 64 bytes to 1518 bytes long, including the FCS but excluding the preamble and SFD. The frame length must be an integer number of octets.</p> <p>Only frames that have a valid FCS are counted by this statistic.</p> <p>VLAN-tagged frames that are larger than 1518 bytes but less than 1522 bytes are also included in this statistic.</p>
Valid Frames Received Rate	<p>Rate at which valid frames are being received.</p> <p>See <i>Valid Frames Received</i> (above) for a description of what constitutes a valid frame.</p>

## IxServer Port CPU Statistics

The table below describes the IxServer Port CPU statistics available in IxLoad.

For the Tcl API, the stat source type for the Port CPU statistics is: Port Monitor

Statistic	Description
Total Memory (KB)	Total amount of RAM installed on the port, in KB. Tcl API name: Total Memory
Free Memory (KB)	Amount of RAM currently available on the port, in KB. Tcl API name: Free Memory
% Disk Utilization	Percentage of space used on the RAM disk installed on the port. Tcl API name: RAM Disk Utilization
CPU Load Avg (1 Minute)	CPU load, averaged over the previous minute. This statistic is displayed as a fraction of 1.0, meaning that 50% CPU utilization would be displayed as 0.5
CPU Load Avg (5 Minutes)	CPU load, averaged over the previous 5 minutes. This statistic is displayed as a fraction of 1.0, meaning that 50% CPU utilization would be displayed as 0.5
CPU Load Avg (15 Minutes)	CPU load, averaged over the previous 15 minutes. This statistic is displayed as a fraction of 1.0, meaning that 50% CPU utilization would be displayed as 0.5

# INDEX

---

## A

Access Attribute Set List 1106  
AccessAttribSetList 1121  
Accounting Attribute Set List 1106  
AcctngAttribSetList 1122  
AddAttacks 1079  
advanced 1300  
Advanced Options 1312, 1324  
Advanced Settings 1608  
Advanced TCP Statistics 1741  
advOptions 1072  
Alternative Capability 1442  
Alternative Capability List 1441  
Alternative Capability Value Set List 1429  
API Objects 1507  
API Overview 1201, 1237, 1255, 1331, 1393  
Attachment 1175, 1184-1185  
AttackListCount 1080  
attacksCmdList 1073  
attacksCmdList nodeList 1075  
Attribute 1008, 1025

---

Attribute List 1119  
Attribute Type and Values 1008, 1026  
Audio Settings 1385, 1420, 1499, 1561, 1661, 1707  
Automatic Settings (CA) 1474  
Automatic Settings (GW) 1467  
availableTosList 1246

## C

Call Managers 1648  
Capability List 1430  
checkTestRunning 1098  
Cloud Rules 1612  
Cloud Servers 1609  
cmdList 1239  
Codec Settings 1370, 1407, 1540, 1650, 1696  
Codecs 1373, 1408, 1491, 1543, 1653, 1698  
Command List 1006, 1011  
config 1070  
Connection Latency Statistics 1746  
contacting Ixia iii  
Content 1134, 1157

## INDEX

---

Control 1007, 1022  
CreateAttackList 1081  
CreatePlaylist 1082  
Curve Segment Statistics 1745  
Custom Activity Link Settings 1431, 1483, 1589,  
1667  
Custom Parameters 1449, 1605, 1669

### D

Data Codecs 1371, 1414, 1489, 1541, 1651,  
1705  
DatabaseVersion 1083  
DeleteAttackList 1084  
DeleteAttacks 1085  
Dial Plan 1443, 1598, 1640, 1694

### E

Edit Contact 1557  
Enable Filter 1319  
Endpoints 1469, 1476  
Events 1364  
Execution Settings 1389, 1433, 1481, 1592,  
1638, 1692  
ExportAttacks 1086

### F

fileList 1298  
Filter List 1310, 1317  
FlowDefinition 1038

### G

Gateways 1478  
GetCapture 1087  
Global Config 1104, 1114, 1203, 1217

---

Global options 1241  
Global Options 1007, 1019

### H

H248 Settings 1368  
H248 TermGroups 1351  
H323 Settings 1436  
Header 1175, 1183  
HTTP settings 1244  
HTTP Statistics 1248  
HTTP Streaming 1237  
HTTP Streaming Client Agent 1238

### I

ImportAttacks (.zatk format) 1088  
ImportUserDefinedAttacks 1089  
InbuiltFlow 1039  
IP, TCP, Run State, and Curve Segment L2/L3, and  
Port CPU Statistics 1731  
Ixia, contacting iii  
IxServer Layer 2-3 Statistics 1748  
IxServer Port CPU Statistics 1750

### L

LDAP 1005  
LDAP Client Agent 1006, 1009  
LDAP Client Commands 1006  
LDAP Statistics 1027  
Limitations 1335, 1393, 1451, 1505, 1513,  
1617, 1671

### M

MailBoxItem 1049, 1059  
MailMessage 1175, 1182, 1185, 1188

---

Matching the TEARDOWN Statistics to Other Statistics 1167

MGC Automatic 1356

MGCP CA Agent 1470

MGCP GW Agent 1456

MGCP Settings (CA) 1472

MGCP Settings (GW) 1465

MGW Automatic 1353

Modification 1007, 1023

MSRP GUI Files 1586

MSRP Relays 1588

MSRP Settings 1583

## N

NoCallControl VOIP Statistics 1676

## O

Objectives 1005, 1035, 1047, 1104, 1131, 1173, 1202, 1223, 1237, 1255, 1285, 1309

Option Set 1202, 1213

Option Set Manager 1203, 1214

Options 1310, 1315

Other Settings 1379, 1416, 1503, 1550, 1665, 1729

Overview 1005, 1047, 1103, 1131, 1173, 1285, 1309

## P

Packages 1362

Peer-to-Peer Application 1035

Peer-to-Peer Application Agent 1036

Peer-to-peer Global Statistics 1041

Per-Interface and TCP Statistics 1732

---

Per-Interface Statistics 1742

POP3 1047

POP3 Client Agent 1047, 1050

POP3 Client Statistics 1062

POP3 Server Agent 1048, 1057

POP3 Server Statistics 1066

POP3 Statistics 1061

Pop3Command 1048, 1053

PresentationItem 1134, 1154

Profiles 1361

Properties 1365

Published Vulnerabilities and Malware 1069

## Q

QT 1095

QuickTest Sample Script 1100

## R

Radius 1103

Radius Client Agent 1104, 1107

RADIUS Client Statistics 1123

Radius Command List 1104, 1108

RenameAttackList 1090

RetrieveAttacks 1091

RTP Settings 1383, 1418, 1497, 1559, 1659, 1725

RTSP 1131

RTSP Client Agent 1131, 1136

RTSP Client Statistics 1160

RTSP Server Agent 1133, 1150

RTSP Server Statistics 1169

## INDEX

---

RTSP Statistics 1159  
RtspCommand 1132, 1141  
RtspgetParamOptionList 1148  
RtspHeader 1133  
RtspHeaders 1132, 1144  
RtspsetParamOptionList 1146  
RuleData 1614  
Run State Statistics 1743  
Running a QuickTest from Tcl 1096

### S

Scenario Settings 1391, 1448, 1480, 1597, 1637, 1691  
SDP Settings 1381, 1496  
SearchAttacks 1092  
Server Network List 1313, 1323  
Server Rules 1611  
settings 1333  
Settings 1510  
Signaling Settings 1553  
Signals 1366  
Simulated Endpoints 1487  
Simulated MGC 1347  
Simulated MGW 1349  
Simultaneous Capability 1435  
Simultaneous Capability List 1447  
Simultaneous Capability Value Set List 1440  
SIP Server List 1511  
Skinny Settings 1645  
SMTP 1173

---

SMTP Client Agent 1173, 1177  
SMTP Client Statistics 1194  
SMTP Server Agent 1176, 1191  
SMTP Server Statistics 1198  
SMTP Statistics 1193  
SmtplibCommand 1174, 1180  
Specific Secrets 1105, 1116  
SRTP Settings 1581, 1727  
SSH 1201  
SSH Client Agent 1202, 1204  
SSH Client Statistics 1218  
SSH Command List 1202, 1206  
startQuickTest 1097  
Stateless Peer 1223  
Stateless Peer Advanced Options 1228  
Stateless Peer Agent 1225  
Stateless Peer Available TOS List 1234  
Stateless Peer Commands 1224  
Stateless Peer Overview 1223  
Stateless Peer Payload Header List 1232  
Stateless Peer Protocol Flows 1229  
Statistics 1325, 1367  
stopQuickTest 1099  
Stream 1134, 1155  
Streaming Client Statistics 1248

### T

T.30 Settings 1573, 1715  
T.38 Settings 1569, 1721  
TCP Statistics 1733, 1737

---

Telnet 1255  
Telnet Client Advanced Options 1256, 1264  
Telnet Client Agent 1255, 1260  
Telnet Client Basic Options 1256, 1263  
Telnet Client Command 1257, 1265  
Telnet Client Statistics 1274  
Telnet Server Advanced Options 1259, 1272  
Telnet Server Agent 1258, 1268  
Telnet Server Basic Options 1258, 1270  
Telnet Server Statistics 1280  
Telnet Statistics 1273  
Terminal Capability Set 1446  
TFTP 1285  
TFTP Client Advanced 1294  
TFTP Client Advanced Options 1286  
TFTP Client Agent 1286, 1288  
TFTP Client Statistics 1302  
TFTP Command List 1286, 1290  
TFTP Server Agent 1296  
TFTP Server Statistics 1306  
Timer Settings 1579  
TLS Cyphers 1604  
TLS Settings 1601  
Trace File Options 1312, 1321  
Trace File Replay 1309  
Trace File Replay Client Agent 1310, 1314  
Trace File Replay Client Commands 1309  
Trace File Replay Client Statistics 1326  
Trace File Replay Server Agent 1311, 1320

---

Trace File Replay Server Commands 1311  
Trace File Replay Server Statistics 1328  
Transfer Address 1595

**U**

Using Auto-Generated Strings 1060

**V**

VDI 1331  
VDI Client Agent 1332  
VDI Client Commands 1334  
Vendor List 1106, 1118  
Video Settings 1424, 1565, 1711  
VoIP H.248 Peer 1335  
VoIP H.323 Peer 1393  
VoIP H248 MGC/MGW Peer API Objects 1338  
VoIP H248 Peer Agent 1340  
VoIP H248 Peer API Commands 1336  
VoIP H248 TermGroup Peer API Objects 1339  
VoIP H323 Peer Agent 1396  
VoIP H323 Peer API Commands 1394  
VoIP H323 Peer API Objects 1395  
VoIP MGCP 1451  
VoIP MGCP CA/MGW Peer API Objects 1454  
VoIP MGCP Endpoint Peer API Objects 1455  
VoIP MGCP Peer API Commands 1452  
VoIP No Call Control Peer 1671  
VoIP No Call Control Peer Agent 1674  
VoIP No Call Control Peer API Commands 1672  
VoIP No Call Control Peer API Objects 1673  
VoIP SIP Cloud 1505

## INDEX

---

VoIP SIP Cloud API Commands 1506

VoIP SIP Peer 1513

VoIP SIP Peer Agent 1517

VoIP SIP Peer API Commands 1514

VoIP SIP Peer API Objects 1515

VoIP Skinny API Objects 1619

VoIP Skinny Peer 1617

VoIP Skinny Peer Agent 1620

VoIP Skinny Peer API Commands 1618

VoIPSIP Cloud Agent 1508