

XG12 Chassis

Release 9.20

Notices

Copyright Notice

© Keysight Technologies 2017-2021

No part of this document may be reproduced in any form or by any means (including electronic storage and retrieval or translation into a foreign language) without prior agreement and written consent from Keysight Technologies, Inc. as governed by United States and international copyright laws.

Warranty

The material contained in this document is provided "as is," and is subject to being changed, without notice, in future editions. Further, to the maximum extent permitted by applicable law, Keysight disclaims all warranties, either express or implied, with regard to this manual and any information contained herein, including but not limited to the implied warranties of merchantability and fitness for a particular purpose. Keysight shall not be liable for errors or for incidental or consequential damages in connection with the furnishing, use, or performance of this document or of any information contained herein. Should Keysight and the user have a separate written agreement with warranty terms covering the material in this document that conflict with these terms, the warranty terms in the separate agreement shall control.

Technology Licenses

The hardware and/or software described in this document are furnished under a license and may be used or copied only in accordance with the terms of such license.

U.S. Government Rights

The Software is "commercial computer software," as defined by Federal Acquisition Regulation ("FAR") 2.101. Pursuant to FAR 12.212 and 27.405-3 and Department of Defense FAR Supplement ("DFARS") 227.7202, the U.S. government acquires commercial computer software

under the same terms by which the software is customarily provided to the public. Accordingly, Keysight provides the Software to U.S. government customers under its standard commercial license, which is embodied in its End User License Agreement (EULA), a copy of which can be found at

<http://www.keysight.com/find/sweula>.

The license set forth in the EULA represents the exclusive authority by which the U.S. government may use, modify, distribute, or disclose the Software. The EULA and the license set forth therein, does not require or permit, among other things, that Keysight: (1) Furnish technical information related to commercial computer software or commercial computer software documentation that is not customarily provided to the public; or (2) Relinquish to, or otherwise provide, the government rights in excess of these rights customarily provided to the public to use, modify, reproduce, release, perform, display, or disclose commercial computer software or commercial computer software documentation. No additional government requirements beyond those set forth in the EULA shall apply, except to the extent that those terms, rights, or licenses are explicitly required from all providers of commercial computer software pursuant to the FAR and the DFARS and are set forth specifically in writing elsewhere in the EULA. Keysight shall be under no obligation to update, revise or otherwise modify the Software. With respect to any technical data as defined by FAR 2.101, pursuant to FAR 12.211 and 27.404.2 and DFARS 227.7102, the U.S. government acquires no greater than Limited Rights as defined in FAR 27.401 or DFAR 227.7103-5 (c), as applicable in any technical data. 52.227-14 (June 1987) or DFAR 252.227-7015 (b)(2) (November 1995), as applicable in any technical data.

Safety Information



Do not proceed beyond a hazard notice until the indicated conditions are fully understood and met.

A **CAUTION** notice denotes a hazardous situation that, if not avoided, could result in minor or moderate injury.

A **WARNING** notice denotes a hazardous situation that, if not avoided, could result in death or serious injury.

Contacting Us

Keysight headquarters

1400 Fountaingrove Parkway
Santa Rosa, CA 95403-1738
www.ixiacom.com/contact/info

Support

| | | |
|---|------------------|--|
| Global Support | +1 818 595 2599 | support@ixiacom.com |
| <i>Regional and local support contacts:</i> | | |
| APAC Support | +91 80 4939 6410 | support@ixiacom.com |
| Australia | +61-742434942 | support@ixiacom.com |
| EMEA Support | +40 21 301 5699 | support-emea@ixiacom.com |
| Greater China Region | +400 898 0598 | support-china@ixiacom.com |
| Hong Kong | +852-30084465 | support@ixiacom.com |
| India Office | +91 80 4939 6410 | support-india@ixiacom.com |
| Japan Head Office | +81 3 5326 1980 | support-japan@ixiacom.com |
| Korea Office | +82 2 3461 0095 | support-korea@ixiacom.com |
| Singapore Office | +65-6215-7700 | support@ixiacom.com |
| Taiwan (local toll-free number) | 00801856991 | support@ixiacom.com |

Documentation conventions

The following documentation conventions are used in this guide:

Describing interactions with the UI

You can interact with products by using different input methods: keyboard, mouse, touch, and more. So in most parts of the user documentation, generic verbs have been used that work with any input method. In cases where input-neutral verbs do not work, mouse-specific verbs are used as the first choice, followed by touch-specific verbs as the second choice.

See the following table for examples on how you can interpret the different input methods.

| Input-neutral | Mouse | Touch |
|---|--|--|
| Select Modify . | Click Modify . | Tap Modify . |
| Select Accounts > Other accounts > Add an account . | Click Accounts > Other accounts > Add an account . | Tap Accounts > Other accounts > Add an account . |
| To open the document in Outline view, select View > Outline . | To open the document in Outline view, click View > Outline . | To open the document in Outline view, tap View > Outline . |
| Select Protocols . | Click the Protocols tab. | Tap Protocols . |
| -NA- | Double-click the Client wizard. | Double-tap the Client wizard. |
| Open the Packages context menu. | Right-click Packages to open the shortcut menu. | Long tap Packages to open the shortcut menu. |

Deprecated words

The following words have been replaced with new words, considering the audience profile, our modern approach to voice and style, and our emphasis to use input-neutral terms that support all input methods.

| Old usage... | New usage... |
|---------------------------------|--------------|
| shortcut menu, right-click menu | context menu |
| click, right-click | select |
| drag and drop | drag |

CONTENTS

| | |
|---|------------|
| Contacting Us | iii |
| Documentation conventions | iv |
| Chapter 1 Introduction | 1 |
| Chapter 2 XG12 Chassis modules | 3 |
| Chapter 3 Install XG12 Chassis | 5 |
| XG12 Chassis installation precautions | 6 |
| Un-pack and mount the chassis | 7 |
| Remove and insert processor module | 8 |
| Remove and insert power supply module | 9 |
| Power cords | 11 |
| Remove and insert fan module | 12 |
| Chapter 4 Log on to XG12 Chassis | 13 |
| INDEX | 15 |

CHAPTER 1 Introduction

This document describes how to install the XG12 chassis and its various modules.

The XG12 Chassis is the next generation high performance platform capable of supporting all XM form factor load modules, including full chassis configurations of the Xcellon-Flex load modules. It is a 12-slot chassis with increased total power capacity available for all load modules and front-to-back airflow delivery along with increased bandwidth from the CPU to the load modules.

The chassis provides improved modularity and access to the major components to reduce downtime of a failed chassis and to reduce the probability of needing to remove a failed chassis from the test environment.



This page intentionally left blank.

CHAPTER 2 XG12 Chassis modules

The modules that make up the chassis are as follows:

- Chassis Frame Module
- Chassis Fan Module
- Chassis Power Supply Module
- Chassis Processor Module

The Processor Module is plugged into the front of the chassis. The power supplies and fans are accessible from the rear of the chassis. Each of the modular components is capable of being removed in the field and replaced with minimum downtime.

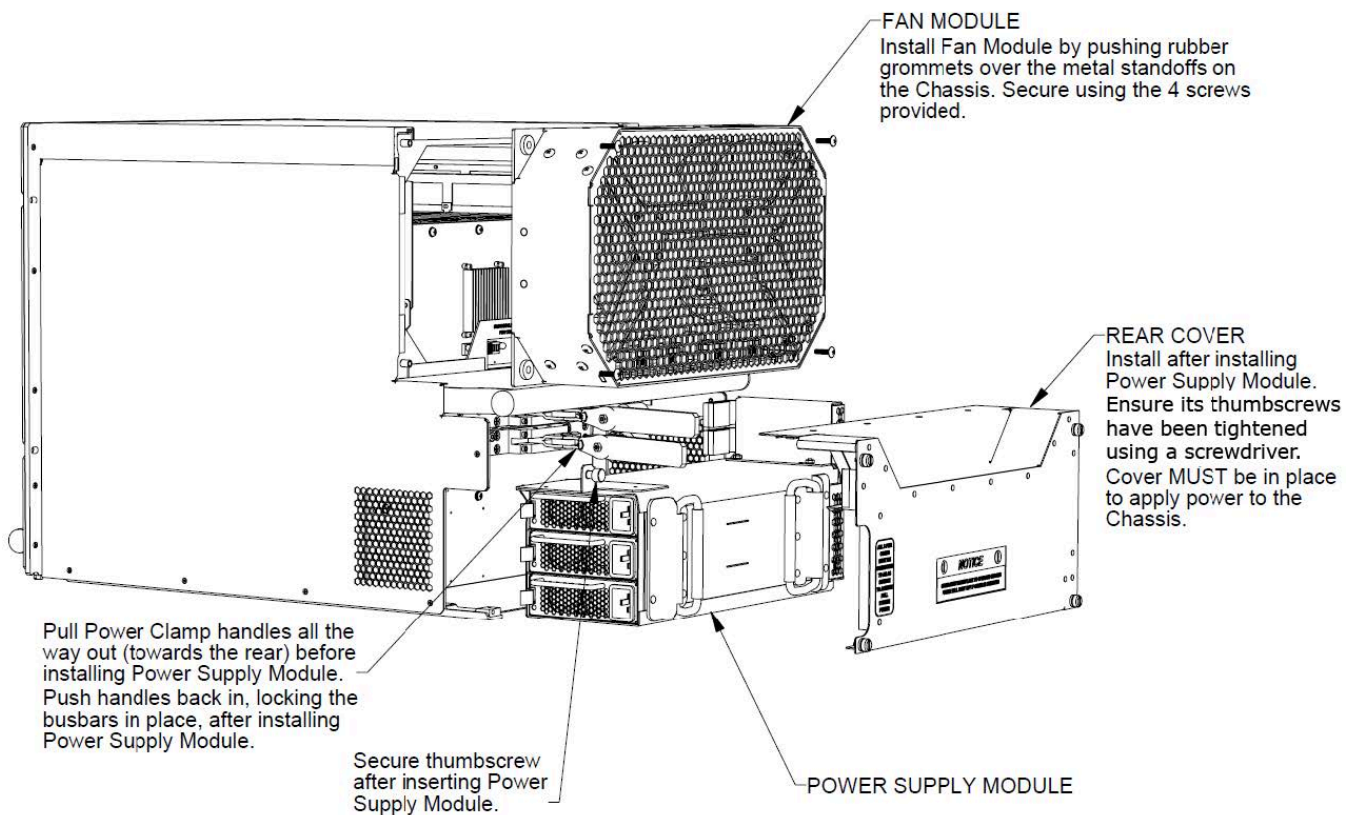

This page intentionally left blank.

CHAPTER 3 Install XG12 Chassis

This section explains the notational and typographical conventions used in this documentation, and provides a list of related documentation.

Section contents:

- XG12 Chassis installation precautions 6**
- Un-pack and mount the chassis 7**
- Remove and insert processor module 8**
- Remove and insert power supply module 9**
- Power cords 11**
- Remove and insert fan module 12**

XG12 Chassis installation precautions

The following precautions should be followed while installing the XG12 chassis:

- The chassis should be installed in the rack before installing the power supply module, fan module and load modules, thereby reducing the weight of the chassis.
- The two lower bolts used to secure the chassis to a rack can be used to hold the chassis frame in place while securing all of the other bolts.
- Secure the chassis to rack face with all six bolts.
- Fully depress power supply clamps when installing power supply module.
- Secure the power supply module thumb bolt when installing power supply module.
- Install the rear power supply cover before applying AC power. After removing or installing this cover, ensure that the thumbscrews are tightened down with a 'Flat Blade' screwdriver.
- Do not use the chassis without installing the Fan module.
- Do not use the chassis without installing the Processor module.
- Do not leave unused slots open. Use the filler panels to cover the un-used slots.
- Do not block the front air intake.
- A minimum air flow clearance of 12 inches is required. 24 inches of air flow clearance is preferred at the rear of the chassis.
- Operator intervention may be required to power cycle the XG12 chassis or restart a software program in the event the XG12 chassis operation is upset or stopped by electrostatic discharge.

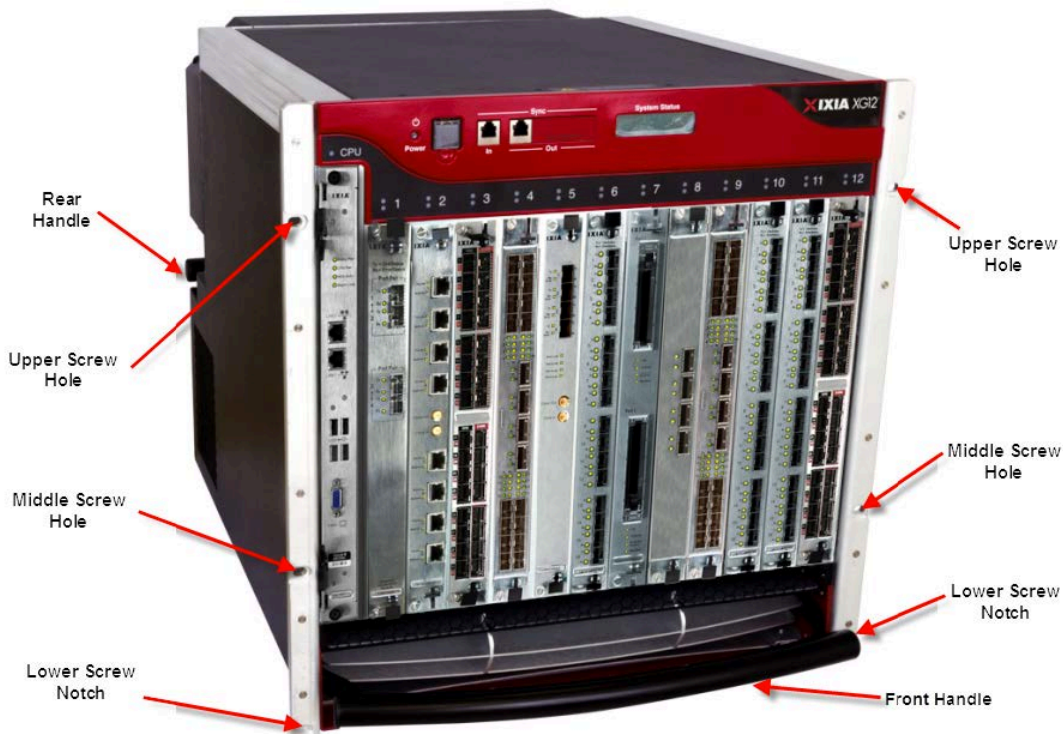

Un-pack and mount the chassis

1. Cut tape and open the carton.
2. Remove accessories box, top foam inserts, and side packing inserts.
3. Lift chassis out of the carton.
4. Remove power supply cover and keep it aside.
5. Remove the plastic wrapping.
6. Insert the lowermost screws on the rack.
7. Slide the chassis into the rack so that the lower screw notches of the chassis rests on the screws on the rack.
8. Insert the other screws and secure the chassis to the rack by tightening the screws.



WARNING: The weight of the chassis components are as follows:

- Empty chassis with air baffles = 70 lbs
- Empty chassis without air baffles = 48 lbs
- 3 power cords = 6 lbs
- Power supply assembly = 29 lbs
- Fan Assembly = 10 lbs
- CPU card = 4 lbs

Do not attempt to lift the fully assembled chassis.

Remove and insert processor module

To remove the processor module:

1. Unfasten the screws.
2. Pinch the clips and then pull outwards.

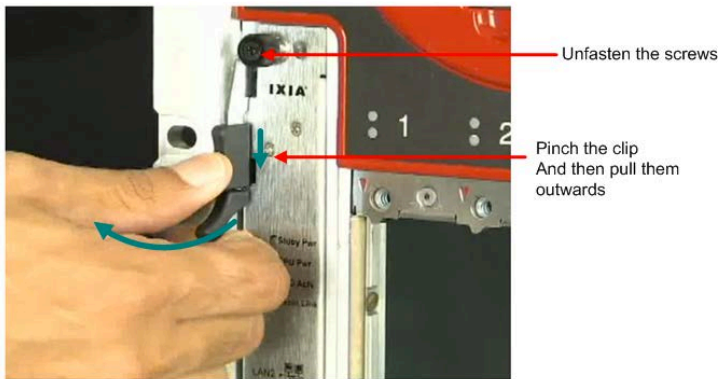

To insert the processor module:

1. Slide the module into the slot.
2. Pinch on the clips and push them in.
3. Fasten the screws.



Remove and insert power supply module

The power supply module is accessible after removing the rear cover.

To remove the rear cover, unfasten the four screws around the cover and pull out the cover.

To remove the power supply module:

1. Loosen the thumbscrew in the upper left corner of the power supply module.
2. Pull the power clamp handles.
3. Hold the two handles provided on the power supply module and pull them.

To remove the individual power supplies,

1. Hold the handle on the power supply
2. Pull the clip inwards and then pull the handle out.

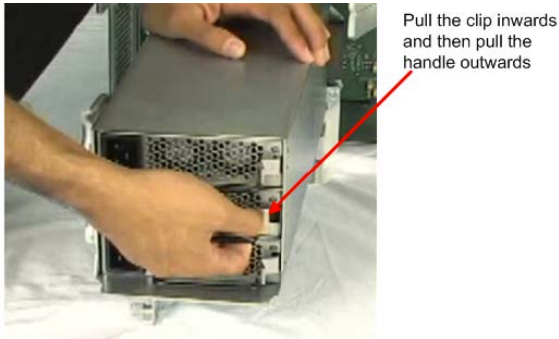

To insert the individual power supplies, slide the power supply in until you hear the clicking sound of the clip.

To insert the power supply module:

1. Place the power supply module on the rails.



2. Push the power supply module inwards.

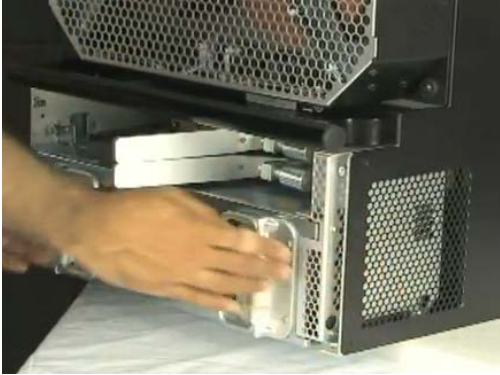

3. Push the power clamp handles in to lock the busbars in place.

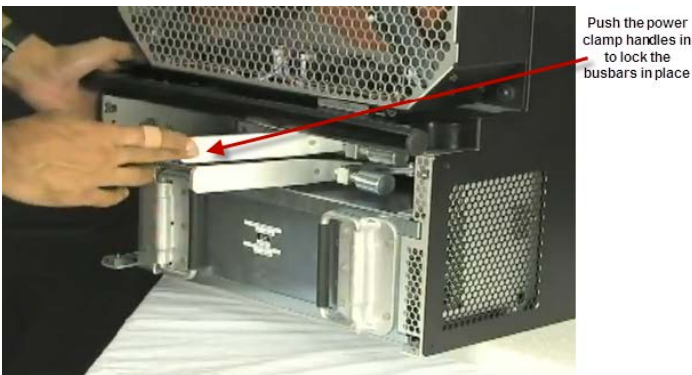

4. To hold the power module in place, tighten the thumbscrew at the upper left corner of the power supply module.



5. Replace the rear cover and fasten it with the screws.

Power cords

The XG12 chassis is CE marked and UL™ certified when using the 200-240VAC power cords supplied with the chassis. However, these certifications for the chassis safety approvals are only valid when the unit is operating from all three 200-240VAC main power sources.

Refer to the *Ixia Platform Reference Manual* at <https://support.ixiacom.com/user-guide/ixos> for more details.

Remove and insert fan module

The fan module is located on the rear side of the chassis.

To remove the fan module:

1. Unfasten the four screws that are present on the edges of the fan module.
2. Pull the module outwards.

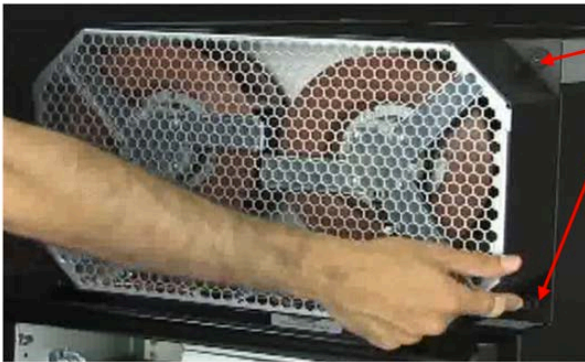

Unfasten the four screws on the edges of the fan module and then pull the module outwards to remove it

To install the fan module:

1. Push the rubber grommets over the metal standoff on the chassis.
2. Fasten the four screws tightly.

CHAPTER 4 Log on to XG12 Chassis

The Username for an XG12 (Windows 7) remote desktop session is **ixia** and the password is the CPU module serial number found on the sticker located in front of the CPU module.

The two network ports on the CPU module are configured by default for DHCP.

 **Note:** The chassis windows wallpaper is not displayed. So the credentials are required to log on.

This page intentionally left blank.

INDEX

C

customer assistance iii

D

do's and don'ts 6

documentation conventions iv

I

Inserting fan module 12

inserting power supply module 9

inserting processor module 8

Installing chassis 5

K

keyboard interactions iv

L

logging on 13

M

modules 3

mounting the chassis 7

mouse interactions iv

O

Overview 1

P

Power cords 11

precautions 6

product support iii

R

Removing fan module 12

removing power supply module 9

removing processor module 8

S

starting chassis 13

support services iii

T

technical support iii

touch interactions iv

U

unpacking the chassis 7



© Keysight Technologies, 2021

Keysight Technologies, Inc.
1400 Fountaingrove Parkway
Santa Rosa, CA 95403-1738

www.keysight.com